



buffet | tabletop | bar



SINCE 1933

2025
INTERNATIONAL
CATALOGUE

APS – Erfolg entsteht im Miteinander

APS – success is built
on collaboration



- familiengeführt in vierter Generation
- eigene Produktion in Deutschland
- Lagerfläche für über 25.000 EUR-Paletten

- family-run company in fourth generation
- own production in Germany
- storage space for over 25,000 EUR pallets



buffet | tabletop | bar

Assheuer + Pott GmbH & Co. KG

Talweg 11 | 59846 Sundern
Germany

Phone: +49 (0) 2933 / 97 35 - 0

info@aps-germany.de

aps-germany.de





p. 106



p. 116



p. 146



Buffet & Display

p. 182



p. 232



p. 244



Buffet & Tableware
Melamine

p. 356



p. 310



p. 330



Tableware &
Table Presentation

p. 390



p. 404



p. 408

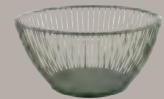

Baskets

p. 424



p. 460



p. 448



Chafing Dish,
GN Container & Transport

p. 470



p. 528



p. 544



Bar, Café & Drinkware

p. 552



p. 562

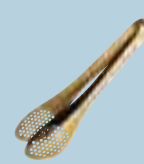

p. 586



Kitchen & Servings tools

p. 600



p. 602



p. 606



Covers & Accessories

Ihr Mehrwert: Inspiration & Service

- ✓ aktuellste Nonfood-Trends im Sortiment
- ✓ hohe Warenverfügbarkeit



Your added value: Inspiration & Service

- ✓ latest nonfood-trends in the range
- ✓ high availability of goods

APS – KNOW-HOW

We only work with the raw material manufacturer who has the best technology in the industry.



MELAMINE

- ✓ 100 % pure melamine
- ✓ BPA free, urea free
- ✓ perfect for serving dishes
- ✓ extremely break and shock resistant
- ✓ sustainable due to durability and robustness
- ✓ hygienic surfaces
- ✓ environmentally friendly due to low processing temperature
- ✓ 100 % dishwasher safe
- ✓ useable up to max. 70 °C

STAINLESS STEEL

- ✓ hygienic surface
- ✓ durable and easy to clean
- ✓ good temperature conductor
- ✓ 100 % dishwasher safe



WOOD ACACIA - BEECH - OAK - OLIVE



PORCELAIN



PLASTIC TRITAN - PP - PS - SAN



- ✓ high resistance to heat
- ✓ durable, no disposable plastic
- ✓ crystal clear
- ✓ hygienic surface
- ✓ easy to clean
- ✓ BPA free

Präzisionsarbeit und Design für Ihren Erfolg

Precision work and design for your success



state-of-the-art
manufacturing
technology



eco-friendly



high
professional
usability

QUALITÄT

- ✓ Jedes Produkt muss mehrere Qualitätskontrollen bestehen.
- ✓ Wir verwenden nur 100 % reines Material.
- ✓ Jedes Rohmaterial wird streng geprüft.

QUALITY

- ✓ Each product must pass several quality checks.
- ✓ We only use 100 % pure material.
- ✓ Each raw material is strictly tested.



APS production | Made in Germany

DESIGN

- ✓ Unsere eigenständig entwickelten Produkte verfügen über zahlreiche Design-Patente im In- und Ausland.
- ✓ Wir entwickeln Produktlösungen für jeden individuellen Kundenbedarf.

DESIGN

- ✓ Our independently developed products have rich / multi design patents at home and abroad.
- ✓ We develop product solutions for every individual customer need.



Design team

Artikel Seite

A
 Abklappbehälter 450
 Abräumwagen 387,460,461
 Abtropfmatte 503
 Adapter / Zwischensteg 452
 Allzweckgießer 339,533
 Antirutschmatte 17
 Aschenbecher 544-549
 Auflaufform 85,445
 Aufstrichmesser 576
 Auslagenplatte/ Kuchenplatte 163
 Ausgießer 324-325,338-339,504,531-533
 Ausstellblech 582
 Austernmesser 573

B
 Backblech 457
 Backform 583
 Backhandschuhe 591
 Baquettekorb 398, 407,413,416
 Bain-Marie 441
 Bar-Caddy 503
 Barlöffel 500
 Barmaß 496-497
 Barmatte 503
 Barsieb 499,502,578
 Becher 290,506-513,519-521
 Becher Emaille 284
 Bento Box 224
 Beschriftungsetiketten 37,348
 Beschriftungskarten 37,348
 Besteckablage 259,465
 Besteckbehälter 29,93-96,105,350-352,394,421,462-463
 Besteckkorb 353,399
 Bestecktaschen 336
 Beton 92,104-105,117,303,313,349,351,478,479,546

B
 Bierglasträger 540
 Bitterflasche 501
 Blattschale Melamin 514,223
 Bonleiste 596
 Bonspieß 596
 Bräter 82-84,442-444
 Brennpastenbehälter Edelstahl 433
 Brezel- oder Wurstständer 66
 Brotstation 70
 Brotkorb 34,64,93,350,390,391-398,400-402,406-414,416,418-421
 Brotmesser 68
 Brotschneidebrett 17,68-70
 Brötchenspende Edelstahl 49
 Brottasche 404-406
 Buffet Box 31,75
 Buffet Kühlset 39-42,44-47
 Buffetleuchte 25-27
 Buffetbrett 72-74
 Buffetgestell 31,37,64,66,76,110-114,289,398
 Buffetkorb 34,396-397,401
 Buffetleiter 110-112
 Buffetschilder 37,348
 Buffetständer 18,67,73,98-101,108,165,225-226,235,299

B
 Buffetständer Edelstahl 226
 Buffetständer Holz 67,101,108
 Buffetständer Metall 18,73,98,99,100,165,225,235,299
 Buffetvitrine 40-42,44
 Butterdose 322-323
 Butterservierer 322
 Bürste Bar 504

C
 Caddy 20,90,173,294,320,321,354,503
 Cappuccinotasse 523
 Cerealienspender 29,106-108
 Cerealienspender Edelstahl 29,106-108
 Chafing Dish 86,87,424-434,437,439
 Chafing Dish Rolltop 432,434,441
 Champagnerkühler 476
 Cocktailmesser 502

D
 Deckel 176,246,249,265,289,441,451-453,455,462,466,520,590,609-610
 Dekanter 21,130-133
 Dekoriermesser 502,572
 Dip-Schälchen 177,184,211,255-258,278-283
 Dispenser Saft 30,121-123,126
 Dispenser Milch 30,126
 Dosier- & Vorratsflasche 501
 Dosierer Zucker 340-341,534,535
 Dosierpumpe 581

Dosierspender 115,581
 Dressingtopf 56,77

E
 Eier-Box 446,581
 Eierbecher 264,323
 Eierkorb 65,403,407
 Eierschneider 577
 Eimer 276,489-490
 Eis-Kugel-Former 487
 Eisbox 35,488-489
 Eiseimer 489-490
 Eisportionierer 567,595
 Eisschaufel 490
 Eiswaffel-Ständer 595
 Eiswasserröhre 117-119
 Eiswürfelform 487
 Eiszange 491,562
 Eiszerkleinerer 490
 Emaille-Artikel 284-285,322
 Entkerner 571
 Espressotasse 522
 Essig- & Öl-Flasche 307
 Etageré 19,22,58,60-63,65,145,235,417

F
 Fadenschneider 570
 Fast-Food Tablett 159,542
 Feuerzangenbowle-Set 329
 Fingerfood-Löffel 178,220,260-261
 Flambierbrenner 595
 Flasche 133,307
 Flaschenhalter Wein 486
 Flaschenkühler 56,105,134,283,470-484,486
 Flaschenöffner 473,485
 Folien-Abreibvorrichtung 597
 Fondue-Set 329
 Frischhaltedeckel 289

G
 Gabel Fleisch 553,556,557
 Gabel Salat 552,560,563-565,592
 Spitzsieb 578
 Gebäckpalette 574
 Gebäckzange 563-567
 Getränkespender 20,116-127,139
 Getränkewanne 135,475
 Gewürzständer 302-308,312
 Gewürzstreuer 318,319,580
 Gießer 324,325,338,339,532,533
 Glasbehälter 21,78-81,108,114,115,117-120,124,125,128-130,287-289,307,321,501,513,533
 Gläserchiene 513
 Glasumrander 503
 Glocke 327,539,596
 Gourmetlöffel 290,594
 GN Abtropfgitter 452,455
 GN Behälter 147,179,265,448-450,453-459
 GN Behälter Edelstahl 147,448-450
 GN Besteckbehälter 35,94,96,394,457,462,463
 GN Buffetgestell 18,28,35,110,111,398
 GN Buffetleiter 110,111
 GN Buffetständer 18,225
 GN Buffetvitrine Edelstahl 40,41
 GN Chafing Dish 425-427,430-434
 GN Deckel 265,451-455,458
 GN Einsatz 16,17,35,38
 GN Haube 34,73,146,147,196,239,398,402,413,441,600-604

G
 GN Holzbox 15
 GN Korb 34,391,394,395,402,412,414
 GN Korb Metall 412,414
 GN Korb Polypropylen 34,391,394,395,402
 GN Naturschieferplatte 16,38,140,141
 GN Partyplatte 158
 GN Rost 457
 GN Schale 55,189,192,203,205,232,251
 GN Schale Melamin 189,192,203,205,232,251
 GN Servierbrett 166,297
 GN Serviergestell 18,35
 GN Tablett 32,33,38,54,146,147,148,179,182,186,190,196,198,202,205,206,208,218,225,229,238-241,247,249,251,263,457,459

G
 GN Tablett Aluminium 54
 GN Tablett Edelstahl 32,146,147,148
 GN Tablett Melamin 38,182,186,190,196,198,202,205,206,208,209,218,225,229,238-241,244,247,249,251,263
 GN Tablett Porzellan 33,457
 GN Wanne 33
 Gourmetgläser 114,287-289

H
 Häkelkorb 406
 Halterung für Flaschenkühler 473
 Haube 34,73,146-148,154-156,164,196,237,252,398,402,413,600-609
 Haube Rolltop 34,73,602,603

Haubenhalterung 49
 Heizelement 139,439,447
 Hobel 66,572
 Holzbox 15,174,292,320
 Honiglöffel 593
 Hummerbrecher 577
 Hygieneschutz 18,48,49,66

I
 Induktionskochplatte 23,88,89,424,426-429,431,436,438,439
 Induktionsstation 23,88,89,436,438
 Infrarotwärmelampe 53,56,440
 Iso-Dispenser 127
 Isolierkanne 138,139

J
 Joghurtspender 115,581

K
 Kaffeebecher 284,447,520,521,523
 Kaffeedispenser Edelstahl 139,447
 Kaffeekanne 138,139,528,529
 Kaffee-Stampfer 530
 Kaffeetasse 446,447,519,522,523
 Kanne 130,131,132,136,138,486,524
 Kanne Saft 21,129-132
 Karaffe 21,128-130,133
 Kartenhalter 308,312,342-347
 Käsehobel 66,572
 Kaviarkühler 157,300
 Kellnermesser 485
 Kreide-Marker 18,37,170,348
 Kochtopf 82-85,442-445
 Konditorplatte 144,162,163,252
 Konferenzkühler 484
 Korb Edelstahl 93,350,418-421
 Korb Metall 60,63-65,407-417
 Korb Polypropylen 34,353,390-403
 Korkenöffner 485
 Kronkorkenschale 484
 Küchenbrett 17,68-74
 Kuchenmesser 68,502,571,573,576
 Kühler für Flaschen 469-484
 Küchenplatte 144,154,157,162,163,236,252
 Kugelausstecher 570
 Kühlakku 611
 Kühlbox 28,39,140
 Kühlkaraffe 132
 Kühlmanschette 486
 Kühlröhre 119
 Kühlschale 28,45-47
 Kühltablett 32,44

L
 Ladestation 25,383,386
 Leuchte 25,356-387
 Likör- und Fondantrichter 578
 Limettenpresse 495,597
 Löffel 178,193,220,259,260,261,290,500,552-561,567,592-594
 Löffelablage 259,465
 Löffel Feinkost 594
 Löffel Fingerfood 178,220,260-262
 Löffel Gourmet 290,594
 Löffel Salat 259,552,555,560,563,565,592
 Löffel Saucen, Dressing 554,555,594
 Löffel Spaghetti 560,561,563
 Lunchbox 467

M
 Magnet-Messerhalter 596
 Marmeladenspender 115,581
 Mehrwegbecher 519-521
 Menage 302-309,312
 Messbecher 584,585
 Messlöffelsatz 567
 Milchdispenser 30,126
 Milchgießer/-kännchen 324,339,528-530,532,533
 Milchkanne 30,126,127,339,528-530
 Milch- und Zucker-Set 339,530
 Minis 177,254,256
 Mobilkochstation 23,88,89,436,438
 Moscow Mule Becher 506-508
 Mühle Pfeffer 310-318
 Mühle Salz 310-318
 Multi Rack 76
 Multibox 137,525
 Multifunktionszange 80,562,563,566,568
 Muscheltopf 299
 Müslispender 29,106,107,108,109,129

N
 Naturschieferplatte 16,38,140,141,142,143,144,145,316

P
 Panierstation 597
 Parmesan Menage 309
 Partyplatte 158

Passiersieb 578
 Pendelschäler 571,572
 Permanent-Ausgießer 504
 Pfanne 150,270,271
 Pfannenwender 553,558,559
 Pfeffermühle 310-319
 Pizzaballenbehälter 466,590
 Pinzettzange 491,569
 Pitcher 130,131,132,134,486
 Pizablech 588
 Pizzaschaufel 589
 Pizzaschneider 573,591
 Platzsets 330-337
 Platzsteller 327
 Podest 18,21,128,129
 Pommes-Frites-Seiher 580
 Porzellaneinsatz 87,437
 Pump-Isolierkanne 139

Q
 Quetschflasche 586,587

R
 Rechnungstablett 152,153,328,536-539
 Regalwagen 461
 Reinigungsbürste 504,505
 Rezeptionsglocke 539,596
 Rolltophaube 28,32,34,39,40,41-45,73,74,140,144,157,252,397,441,602,603
 Rolltop-Set 28,32,42,45,144,157
 Rührbecher 585
 Rührglas 500

S
 Saftdispenser 20,30,116,117-121,122,124-127
 Saftkanne 130-132,486
 Sahnegießer 324,325,336,339,531-533
 Salatbesteck 562-568,592
 Salatzeuge 80,560,562-568
 Salatlöffel 259,554,555,559
 Salzmühle 310-318
 Samowar 446
 Sauciere 325-327,531
 Saucengießlöffel 554,555
 Schälchen 115,177,184,211,254-258,278-283
 Schälchenspender 115
 Schale Aluminium 52,53,55,275
 Schale Beton 101,104
 Schale Edelstahl 57,150,270,273-276,281-283,415,419
 Schale Emaille 284,285,322
 Schale Glas 112-115,610
 Schale Holz 102,103,165,172,174,295,296
 Schale Melamin 28,45,183,185-189,191,193,195,197,198-201,203-207,209-217,219,221-236,241,243,245-258,261-263,299
 Schale PET 175-178
 Schaufel 490,582,589,590,592
 Schaufel Metall 582,590
 Schaumlöffel 559,561
 Schaumspesering 583
 Schiefer 16,38,39,65,140,145,157,169,170,241,242,291,316
 Schilder 37,62,77,348
 Schlüsselschnur 484
 Schneebesens 577
 Schneidbrettständer 595
 Schneidebrett 17,50,68-72,74,167,502,538
 Schneidmesser 68,502,572
 Schöpflöffel 552,556,557,560,561
 Seiher 580
 Sektglas 518
 Sektkühler 135,470-474,477,483,490
 Senftöpfchen 304
 Servierbox 15-17,31,35-38,70,75,81,94,174,292,320,463
 Serviertöpfchen 270,271
 Servier- / Tortenplatte Edelstahl 154,163
 Servier- / Tortenplatte Holz 162
 Servier- / Tortenplatte Melamin 163,187,236,252
 Servier- / Tortenplatte Schiefer 144
 Servierbrett 50,58,59,62,68-74,166-171,174,273,291-295,297,414,538
 Servier-Fritterkorb 272
 Serviergabel 553
 Serviergestell 60,65,114,289
 Servierkerle 277
 Servierkorb 34,60-66,93,272,276,350,353,390,391,392-403,406-421
 Servierlöffel 178,193,220,259-261,290,552-561,592-594
 Servierpfanne 150,269-271
 Servierplatte 16,33,38,140-144,154,157-158,187,236,239,242,263
 Servierset 193
 Serviertablett 22,150,152,153,160,161,167,292,298,300,301,536,537,540,541

Serviertisch	22,167,301
Servierwagen	97,387,460,461
Servierzange	80,491,560,562-568
Serviettenhalter	17,90-92,105
Serviettenringe	328
Serviettentaschen	336
Shaker	492-494,512
Sieb	130,131,499,502,535,549,578,579
Snackbox	277
Snackholder	272-274,276
Snackpresenter	51,277
Snackspender	321,513,533
Spachtel	575,576
Spaghettizange	560,563
Spargelzange	564
Sparschäler	571,572
Speisenwärmer	23,86-89,137,424-440,525
Spritzflasche	308,501
Standascher	549
Ständer	18,22,23,50,58,59,66,67,73,89,98-101,107,108,115,165,167,225,226,235,237,253,299,301,303,344,347,420,472,473,595
Ständer Wein- / Sektkühler	472,473
Staubkappen	504
Stielglas	518
Stielkasserolle	268,269,271
Stift	18,37,170,348
Stößel	498
Stövchen	137,525
Streuer	302,305,306,318,319,580
Streuer Pfeffer	310-319
Streuer Salz	310-319
Superbox	36-38
Suppenkelle	554,555
Suppentopf	435
Sushiboard Holz	166,297
Sushiboard Melamin	198,200,213

T	
Table Caddy	20,90,173,294,320,321,354
Tablett	22,28,32,33,38-45,54,63,70,71,103,142,146-157,159-161,166,167,179,182,186,187,190,196,198,200-202,205,206,208,209,213,216,218-220,225,227,229,230,236,238-244,247,249,251,252,263,292,297,298,300,301,328,393,417,457,459,530,536,537-542,604
Tablett Edelstahl	32,33,39-44,144,154-157,263
Tablett Fast Food	159,542
Tablett Holz	22,32,44,63,73,103,156,166,167,2,92,297,298,301,417
Tablett Melamin	28,63,71,142,182,186,187,190,196,198,200-202,205,206,208,209,213,216,218-220,225,227,229,230,236,238-244,247,249,251,252,263,538
Tablettständer	22,167,301
Tamper	530
Tasse	446,447,519,520,522,523
Teebecher	446,519-521
Teebox	137,525
Teebrühsieb	535
Teekanne	136,446,524
Teigbehälter	466,590
Teigschaber / Abstecher	576,590
Teispachtel	575,576
Teller Emaille	231
Teller Fingerfood	186,198,200,203,216,219,222,224,230,257,262,281
Teller Melamin	187,190,194,197-207,209,213,216,219,222,224,230,231,245,252,257,262
Thermometer	529
Thermo Tablett-Set	43
Thermo-Set	45
Tin in Tin Shaker	492
Tischaufsteller	346,348
Tischhalterung für Sektkühler	473
Tischkartenhalter	343-347
Tischkrümelentferner	327,539
Tischleuchte	356-387
Tischorganizer	20,90,173,294,320,321,354
Tischrestbehälter	352,354-355
Tischsets	330-337
Tortenheber	553-555
Tortennmesser	554
Tortenplatte	144,154,162-164,252,606
Tortenring	583
To-Go Becher	520,521
Transportwagen	97,387,460,461
Tretbeutelhalter	543
Trichter	578,579
Trinkbecher	124,125,284,506-522
Trinkflasche	526,527
Trinkglas	124,514-518
Trinkhalme	505
Tropfenschale Melamin	119,125

U	
Universalbox	35,81
Universalkanne	130,131,132,138,139,528,529
Universalzange	80,491,560,562-568
Untersetzer Edelstahl	328
Untersetzer Kork	124,125,591
Untersetzer Melamin	20,116,119
Untersetzer Naturschiefer	143,316
Untertasse	447,522,523
V	
Vase	349
Verschluss Wein / Champagner	504
Vorspeisenzange	563
Vorratsglas	78-81
W	
Wachspapier	143,151,173,274,298,538
Wanne	33,35,135,467,475
Warenträger	332
Wärmebrücke	53,56,440
Wärme-Kies	441
Wärmelampe	53,56,440
Wärmeplatte	440
Warnschild	594,611
Wasserbadschüssel	579
Wasserglas	514-518
Wasserkanne	130-132
Wasserspender	20,116-120,124,125
Weck-Gläser	114,287-289
Weck-Flaschen	286
Weinglas	518
Weinkühler	135,470-474,477,483
Weinkühlerständer	472,473
Wellenschliffmesser	68
Wender	553,557-559,561,574,575
Windaschenbecher	544-549
Windlicht	349
Z	
Zange	80,491,560,562-569
Ziseliernmesser	571
Zitronenschnitzelpresse	495,597
Zitruspresse	495,597
Zuckerdosierer	340,341,534,535
Zuckerkugel	340,535
Zuckerspender	340,341,534,535
Zutatenbehälter	502

ENGLISH

item	page
A	
adapter	452
air pot	139
airtight cover	289
all-purpose tong	80,491,560,562-568
appetizer tong	563
ashtray	544-549
asparagus tongs	564
B	
baguette basket	398,407,413,416
bain marie bailing bowl	579
bain-marie	441
baking dish	85,445
baking mittens	591
baking pan	583
baking sheet	457
bar caddy	503
bar knife	502
bar spoon	500
bar strainer	499,502,578
barrel mug	290,506-513,519-521
basket metal	60,63-65,407-417
basket polypropylene	34,353,390-403
basket stainless steel	93,350,418-421
beaker	284
beer rack	540
Bento Box	224
beverage dispenser	20,116-127,124,139
beverage tub	135,475
bill presenter	152,153,328,536,537,538,539
bill rail	596
bill spike	596
bottle	133,307
bottle cooler	56,105,134,283,470-484,486
bottle fuel	433
bottle opener	473,485
bowl aluminium	52,53,55,275
bowl concrete	101,104
bowl enamel	284,285,322
bowl glass	112-115,610
bowl holder	115
bowl melamine	28,45,183,185-189,191,193,195,197-201,203-207,209-217,219,222-224,226,227-236,241,243,245-251,253-258,261-263,299
bowl stainless steel	57,150,270,273,274,276,281-283,415,419
bowl wood	102,103,165,172,174,295,296
bracket for bottle cooler	473
bread basket	404-406
bread knife	68
bread station	70
breadbox	34,64,93,350,390,391-398,400-402,406-414,416,418-421
breeding set	597
bucket	276,489-490
buffet basket	34,396-397,401
buffet box	31,75
buffet ladder	110-112
buffet light	25-27
buffet signs	37,348
buffet stand	18,31,37,64,66,67,73,76,98-101,108,110-114,165,225-226,235,289,299,398
buffet stand metal	18,73,98,99,100,165,225,235,299
buffet stand stainless steel	226
buffet stand wood	67,101,108
buffett-board	72-74
butter dish	322-323
C	
caddy	20,90,173,294,320,321,354,503
cake knife	68,502,571,573,576
cake lifter	553-555
cake plate	144,154,157,162,163,236,252
cake plate melamine	163,187,236,252
cake plate stainless steel	154,163
cake plate wood	162
cake setting ring	583
cake slice	554
cake stand	144,154,162-164,252,606
cake stand	144,162,163,252
canele / decorating knife	571
cap bowl	484
cappuccino cup	523
carafe	21,128-130,133
caviar cooler	157,300
cereal dispenser	29,106-108
cereal dispenser	29,106,107,108,109,129
cereal dispenser stainless steel	29,106-108
chafing dish	86,87,424-434,437,439
chafing dish rolltop	432,434,441

chalk marker	18,37,170,348
champagne bowl	135,470-474,476,477,483,490
champagne bucket table holder	473
champagne glass	518
champagne/wine saver	504
charging station	25,383,386
cheese dish	309
cheese slicer	66,572
chefs blow torch	595
chopping board	17,50,68-72,74,167,502,538
citrus squeezer	495,597
cleaning brush	504,505
clingfilm tear-off dispenser	597
cloche / dome cover	327,539,596
coaster cork	124,125,591
coaster melamine	20,116,119
coaster natural slate	143,316
coaster stainless steel	328
coffee cup	284,446,447,519-523
coffee dispenser stainless steel	139,447
coffee pot	138,139,528,529
coffee tamper	530
concrete	92,104-105,117,303,313,349,351,478,479,546
condiment holder	502
confectionery funnel	578
conference bottle cooler	484
conical strainer	578
container	33,35,135,467,475
cooking pot with lid	82-85,442-445
cool collar	486
cooler	611
cooler for bottles	469-484
cooling bowl	28,45-47
cooling box	28,39,140
cooling carafe	132
cooling plates	32,44
cooling tube	119
corer	571
corkscrew	485
cornet stand	595
corner	34,73,146-148,154-156,164,176,196,237,246,249,252,265,289,398,402,413,441,451-453,455,462,466,520,590,600-610
cover holder	49
creamer	324,325,336,339,531-533
crochet rope basket	406
cumber	327,539
curler	66,572
cutlery bag	336
cutlery dispenser	353,399
cutlery organizer	29,93-96,105,350-352,394,421,462-463
cutlery rest	259,465
cutting board	17,68-70
cutting board rack	595
cutting knife	68,502,572
D	
decanter	21,130-133
decorating knife	502,572
decorator / zester	570
delicatessen spoon	594
designation cards	37,348
dip bowl	177,184,211,255-258,278,279,280,283
dispenser sugar	340-341,534,535
display	332
display plate	163
display tray	582
dosing dispenser	115,581
dosing pump	581
dough container	466,590
dough scraper	576,590
dough spatula	575,576
dressing pot	56,77
dressing/sauce spoon	554,555,594
drinking bottle	526,527
drinking cup	124,514-518
drinking cups	124,125,284,506-522
drip mat	503
drip tray melamine	119,125
dust & fly cap	504
E	
egg basket	65,403,407
egg cutter	577
egg holder	264,323
eggs box	446,581
enamel articles	284-285,322
espresso cup	522
F	
fingerfood plate	186,198,200,203,216,219,222,224,230,257,262,281
fire punch bowl set	329
flower vase	349
fondue set	329

fork	553
free flow pourer	504
fry baskets	272
fry dripping tray	580
funnel	578,579

G	
glass container	21,78-81,108,114,115,117-120,124,125,128-130,287-289,307,321,501,513,533
glass rack	513
glass rimmer	503
GN basket	34,391,394,395,402,412,414
GN basket metal	412,414
GN basket polypropylene	34,391,394,395,402
GN bowl	55,189,192,203,205,232,251
GN bowl melamine	189,192,203,205,232,251
GN buffet display stainless steel	40,41
GN buffet ladder	110,111
GN buffet stand	18,28,35,110,111,225,398
GN chafing dish	425-427,430-434
GN cover	34,73,146,147,196,239,398,402,413,441,600-604
GN cutlery organizer	35,94,96,394,457,462,463
GN grid	457
GN insert	16,17,35,38
GN natural slate tray	16,38,140,141
GN pan stainless steel	147,448-450
GN partytray	158
GN serving board	166,297
GN serving stand	18,35
GN tray	32,33,38,54,146,147,148,179,182,186,190,196,198,202,205,206,208,218,225,229,238-241,247,249,251,263,457,459
GN tray aluminium	54
GN tray melamine	38,182,186,190,196,198,202,205,206,208,209,218,225,229,238-241,244,247,249,251,263
GN tray porcelain	33,457
GN tray stainless steel	32,146,147,148
GN woodbox	15
GN-container	147,179,265,448-450,453-459
GN-drainer	452,455
GN-lid	265,451-455,458
gourmet glasses	114,287-289
graduated jug	584,585
granite chips	441
gravy boat	325-327,531
greaseproof paper squares	143,151,173,274,298,538

H	
heating plate	440
heating unit	139,439,447
honey spoon	593
hygienic cover	18,48,49,66

I	
ice ball former	487
ice box	35,488-489
ice bucket	489-490
ice cream scoop	567,595
ice crusher	490
ice cube cooling tube	117-119
ice cube maker	487
ice scoop	490
ice tong	491,562
induction plate	23,88,89,424,426-431,436-439
induction station	23,88,89,436,438
insulated dispenser	127

J	
jam dispenser	115,581
jar	78-81
jigger	496-497
jug	130,131,132,138,139,528,529
juice dispenser	20,30,116,117-121,122,124-127
juice pitcher	21,129-132,486

K	
key cord	484
kitchen board	17,68-74

L	
labeling labels	37,348
labels	37,62,77,348
ladle	552,556,557,560,561
lamp	25,356-387
leaf melamine	514,223
lemon slice squeezer	495,597
lime press	495,597
lobster cracker	577
lunchbox	467

M	
magnetic knife rack	596
meat fork	553,556,557
melon baller	570
menage	302-309,312
milk and sugar set	339,530
milk dispenser	30,126,127,339,528-530

milk jug	324,339,528-530,532,533
mini bowl	115,177,184,211,254-258,278-280,283
mixing glass	500
mobile cooking station	23,88,89,436,438
Moscow Mule barrel mug	506-508
mousse ring	583
muddler	498
mug	446,447,519,520,522,523
multi rack	76
multibox	137,525
multifunction pliers	80,562,563,566,568
mussel pot	299
mustard glass	304

N	
napkin bag	336
napkin holder	17,90-92,105
napkin rings	328
natural slate tray	16,38,140-145,316
non slip mat	17

O	
oil- and vinegar bottle	307
oyster knife	573

P	
pan	150,269-271
party spoon	178,220,260-261,290,594
partytray	158
pastry spatula	574
pastry tongs	563-567
pedal bin	543
peeler	571,572
pen	18,37,170,348
pepper mill	310-318
PET bowl	175-178
pitcher	130,131,132,136,138,486,524
pizza cutter	573,591
pizza dish	588
pizza dough container	466,590
pizza peel	589
placemat	330-337
plate enamel	231
plate melamine	187,190,194,197-203,206-209,213,216,219,222,224,230,231,245,252,257,262
plate tray	327
plate warmer	23,86-89,137,424-440,525
podest	18,21,128,129
porcelain insert	87,437
pourer	324,325,338,339,532,533
pourers	324-325,338-339,504,531-533
pouring container	501
pretzel-/ sausage stand	66

R	
refrigerated buffet display	39-42,44-47
reusable cup	519-521
ring bell	539,596
roasting pan	82-84,442-444
roll dispenser stainless	49
roltop cover	28,32,34,39,40,41,42,44,45,73,74,140,144,157,252,397,441,602,603
roltop set	28,32,42,45,144,157

S	
salad fork	552,560,563-565,592
salad spoon	259,552-555,559,560,563,565,592
salad spoon + fork	562-568,592
salad tong	80,560,562-568
salt mill	310-319
samovar	446
sandwich knife	576
sauce / gravy ladle	554,555
saucer	447,522,523
sauté pan / mini sauce pan	268,269,271
scoop	490,582,589,590,592
scoop flour	582,590
scraper	575,576
serrated knife	68
service trolley	97,387,460,461
serving basket	34,60-66,93,272,276,350,353,390,391,392-403,406-421
serving board	50,58,59,62,68-74,166-171,174,273,291-295,297,414,538

serving box	15-17,31,35-38,70,75,81,94,174,292,320,463
serving cup	272-274,276
serving plate	16,33,38,140-144,154,157,158,187,236,239,242,263
serving set	193
serving spoon	178,193,220,259-261,290,552-561,592-594
serving stand	18,22,23,50,58,59,65-67,73,89,98-101,107,108,114,115,165,167,225,226,235,237,253,289,299,301,303,344,347,420,472,473,595
serving table	22,167,301
serving tongs	80,491,560,562-568
serving trolley	97,387,460,461

serving trowel	277
set measuring spoon	567
shaker	302,305,306,318,319,492-494,512,580
showcase	40-42,44
skimmer	559,561
slate	16,38,39,65,140145,157,169,170,241,242,291,316

slate serving / cake plate	144
small serving pot	270,271
snack dispenser	321,513,533
snack tray	159,542
snackbox	277
snackpresenter	51,277
snap mesh tea ball	535
soup ladle	554,555
soup pot	435
spaghetti spoon	560,561,563
spaghetti tong	560,563
spice rack	302-308,312
spice shaker	318,319,580
spoon	178,193,220,259,260,261,290,500,552-561,567,592-594
spoon rest	259,465
spray bottle	501
squeeze bottle	308,501,586,587
stand for wine	472,473
stand for wine / champagne bowl	472,473
standing ashtray	549
stirring cup	585
strainer	130,131,499,502,535,549,578,579
straws	505
sugar dispenser	340,341,534,535
sugar pot	340,535
superbox	36-38
sushiboard melamine	198,200,213
sushiboard wood	166,297
swivel peeler	571,572

T	
table caddy	20,90,173,294,320,321,354
table garbage bin	352,354-355
table lamp	356-387
table mats	330-337
table organiser	20,90,173,294,320,321,354
table stands	308,312,342-348
tamper	530
tapping container	450
tea cup	446,519-521
tea-box	137,525
teapot	136,446,524
teapot warmer	137,525
thermal bridge	53,56,440
thermo set	45
thermo tray	43
thermometer	529
tin in tin shaker	492
to-go cup	520,521
tong	80,491,560,562-569
tray	22,28,32,33,38-45,54,63,70,71,103,142,146-157,159-161,166,167,179,182,186,187,190,196,198,200-202,205,206,208,209,213,216,218-220,225,227,229,230,236,238-244,247,249,251,252,263,292,297,298,300,301,328,393,417,457,459,530,536,537-542,604
tray melamine	28,63,71,142,182,186,187,190,196,198,200-202,205,206,208,209,213,216,218-220,225,227,229,230,236,238-244,247,249,251,252,263,538
tray stainless steel	32,33,39-44,144,154,155,157,263
tray stand	22,167,301
tray wood	22,32,44,63,73,103,156,166,167,292,297,298,301,417
trolley	461
turner	553,557-559,561,574,575
tweezer	491,569

U	
universal box	35,81

V	
vacuum jug	138,139

W	
waiter's corkscrew	485
warning sign	594,611
water cup	514-518
water pitcher	130-132
Weck-bottles	286
Weck-glasses	114,287-289
whisk	577
wind lights / candle holder	349
wine bowl	135,470-474,477,483
wine glass	518
winebottle-stand	486
woodbox	15,174,292,320
yoghurt dispenser	115,581

artículos **pág.**

A

abre ostras 573
 abridor 473,485
 acumulador de frío 611
 adaptador 452
 alicates multifunción 80,562,563,566,568
 aro anti-goteo melamina 119,125
 aro de tarta 583
 aro redondo para semifríos 583
 artículos esmaltados 284-285,322
 azucarero 340-341,534,535

B

bajo plato 327
 bandeja 22,28,32,33,38-45,54,63,70,71,103,142,146-157,159-161,166,167,179,182,186,187,190,196,198,200-202,205,206-209,213,216,218-220,225,227,229,230,236,238-244,247,249,251,252,263,292,297,298,300,301,328,393,417,457,459,530,536,537-542,604
 bandeja acero inoxidable 32,33,39-44,144,154,155,157,263
 bandeja autoservicio y snacks 159,542
 bandeja con alturas 19,22,58,60-63,65,145,235,417
 bandeja de pizarra natural 16,38,140,141,142,143,144,145,316
 bandeja de porcelana 87,437
 bandeja isotérmica 45
 bandeja madera 22,32,44,63,73,103,156,166,167,292,297,298,301,417
 bandeja melamina 28,63,71,142,182,186,187,190,196,198,200-202,205,206,208,209,213,216,218-220,225,227,229,230,236,238-244,247,249,251,252,263,538
 bandeja para sushi melamina 198,200,213
 bandeja party 158
 bandeja pastelera 457,582
 bandeja tartas acero inoxidable 154,163
 bandeja tartas madera 162
 bandeja tartas melamina 163,187,236,252
 bandeja termo 43
 bandejas refrigeradas 32,44
 baño maría 441
 barra magnética para cuchillos 596
 barreño botellines 135,475
 batidor 577
 bento box 224
 bol refrigerado 28,45-47
 bolsa cubiertos 336
 bolsa de servilletas 336
 bomba dosificadora 581
 bote 78-81
 bote de mostaza 304
 bote dosificador flexible 586,587
 bote vertedor universal 339,533
 botella 133,307
 botella „store & pour“ 501
 botella de aceite y vinagre 307
 botella de combustible líquido 433
 botella exprimible 308,501
 botes especieros 318,319,580

C

caballetes buffet 37,348
 caballetes de mesa 346,348
 cacerola 150,270,271
 caddy 20,90,173,294,320,321,354,503
 caddy de mesa 20,90,173,294,320,321,354
 cafetera 138,139,528,529
 caja comida 15-17,31,35-38,70,75,81,94,174,292,320,463
 caja de buffet 31,75
 caja de pan para buffet 34,64,93,350,390,391-398,400-402,406-414,416,418-421
 caja dispensadora 35,81
 caja madera 15,174,292,320
 caja para huevos 446,581
 caja para té 137,525
 calentador de tetera 137,525
 caliente platos 23,86-89,137,424-440,525
 campana 34,73,146-148,154-156,164,196,237,252,398,402,413,600-609
 campana esférica 327,539,596
 campana rolltop 28,32,34,39,40,41,42,44,45,73,74,140,144,157,252,397,441,602,603
 cantimplora 526,527
 carro 461
 carro de servicio 97,387,460,461
 cazo para baño maría 579
 cazo recto bajo 268,269,271
 cazuela 85,445

cenicero 544-549
 cenicero de pie 549
 cepillo de limpieza 504,505
 cesta acero inoxidable 93,350,418-421
 cesta de buffet 34,396-397,401
 cesta de cuerda de ganchillo 406
 cesta de huevos 65,403,407
 cesta metal 60,63-65,407-417
 cesta para baguette 398,407,413,416
 cesta para servir 34,60-66,93,272,276,350,353,390,391,392-403,406-421
 cesta polipropileno 34,353,390-403
 cestitas para el servicio mesa 272
 chafing dish 86,87,424-434,437,439
 chafing dish rolltop 432,434,441
 champañera 476
 coctelera 492-494,512
 colador 130,131,499,502,535,549,578-580
 colador cónico 578
 colador de cóctel 499,502,578
 conjunto aperitivo 302-309,312
 contenedor knock-out 450
 copa de champán 518
 copa de vino 518
 corta huevos 577
 corta pasta 576,590
 cortador de pizza 573,591
 cremier 324,325,336,339,531-533
 cubeta 33,35,135,467,475
 cubierta higiénica antialiento 18,48,49,66
 cubitera 35,488-489
 cubitera isotérmica 489-490
 cubitera para cava 135,470-474,477,483,490
 cubitera para vino 135,470-474,477,483
 cubo 276,489-490
 cuchara 178,193,220,259,260,261,290,500,552-561,567,592-594
 cuchara de espaguetis 560,561,563
 cuchara de miel 593
 cuchara gourmet 290,594
 cuchara para ensalada 259,552,554,555,559,560,563,565,592
 cuchara para helado 567,595
 cuchara para servir 178,193,220,259-261,290,552-561,592-594
 cuchara party 178,220,260-262
 cucharilla de cóctel 500
 cucharón 552,556,557,560,561
 cucharón de salsa 554,555
 cucharón de salsa/aliño 554,555,594
 cucharón de sopa 554,555
 cuchillo acanalador 502,572
 cuchillo de corte 68,502,572
 cuchillo de decoración cincelador 570,571
 cuchillo dentado 68
 cuchillo para cóctel 502
 cuchillo para pan 68
 cuchillo para tartas 68,502,571,573,576
 cuchillo para untar 576
 cuenco acero inoxidable 57,150,270,273,274,276,281-283,415,419
 cuenco aluminio 52,53,55,275
 cuenco de vidrio 112-115,610
 cuenco esmaltado 284,285,322
 cuenco hormigón 101,104
 cuenco madera 102,103,165,172,174,295,296
 cuenco melamina 28,45,183,185,187,188,189,191,193,195,197,198-201,203-205,207,209-217,219,221,223,224,226,227-236,241,243,245-251,253-258,261-263,299
 cuenco mini 177,254,256
 cuenco para chapas 484
 cuenco para dip 177,184,211,255-256,258,278,279,280,283
 cuenco PET 175-178

D

decantador 21,130-133
 descorazonador 571
 dispensador buffet en escalera 110-112
 dispensador de bebidas 20,116-127,139
 dispensador de bocadillos 51,277
 dispensador de café acero inoxidable 139,447
 dispensador de cereales 29,106-109,129
 dispensador de cereales acero inoxidable 29,106-108
 dispensador de film 597
 dispensador de leche 30,126,127,339,528-530
 dispensador de mermelada 115,581
 dispensador de panecillos acero inoxidable 49
 dispensador de snacks 321,513,533
 dispensador de yogur 115,581
 dispensador de zumo 20,30,116,117-127
 dispensador en escalera 76
 dispensador isotérmico 127
 dosificador 115,581

E

embudo 578,579
 embudo dosificador 578
 enfriador de botellas 56,105,134,283,470-484,486
 enfriador de caviar 157,300
 enfriador múltiple 484
 enfriador para botellas 469-484
 escurridor de fritos 580
 espátula 553,558,559
 espátula 553,557-559,561,574,575
 espátula masa 575,576
 espátula plancha 575,576
 especiero 302-308,312
 espumadera 559,561
 estación de carga 25,383,386
 estación de cocina móvil 23,88,89,436,438
 estación de empanado 597
 estación de inducción 23,88,89,436,438
 estación pan 70
 esterilla antideslizante 17
 esterilla escurridora 503
 etiquetas 37,62,77,348
 expositor 332
 expositor buffet 31,37,64,66,76,110-114,289,398
 expositor buffet frío 28,39,140
 expositor de buffet 18,67,73,98-101,108,165,225-226,235,299
 expositor de buffet acero inoxidable 226
 expositor de buffet madera 67,101,108
 expositor de buffet metal 18,73,98,99,100,165,225,235,299
 expositor para tartas 163
 exprimidor cítricos 495,597

F

fiambarrera 467
 florero 349
 fuente de servir 16,33,38,140-144,154,157-158,187,236,239,242,263
 fuente en forma de hoja melamina 514,223
 fuente para la mesa 150,269-271
 funda de frío 486

G

GN bandeja 32,33,38,54,146,147,148,179,182,186,190,196,198,202,205,206,208,218,225,229,238-241,247,249,251,263,457,459
 GN bandeja acero inoxidable 32,146,147,148
 GN bandeja aluminio 54
 GN bandeja de pizarra natural 16,38,140,141
 GN bandeja melamina 38,182,186,190,196,198,202,205,206,208,209,218,225,229,238-241,244,247,249,251,263
 GN bandeja party 158
 GN bandeja porcelana 33,457
 GN caja madera 15
 GN campana 34,73,146,147,196,239,398,402,413,441,600-604
 GN cesta 34,391,394,395,402,412,414
 GN cesta metal 412,414
 GN cesta polipropileno 34,391,394,395,402
 GN chafing dish 425-427,430-434
 GN cubeta 33,147,179,265,448-450,453-459
 GN cubeta acero inoxidable 147,448-450
 GN cuenco 55,189,192,203,205,232,251
 GN cuenco melamina 189,192,203,205,232,251
 GN dispensador buffet en escalera 110,111
 GN escurridor 452,455
 GN expositor buffet acero inoxidable 40,41
 GN porta cubiertos 35,94,96,394,457,462,463
 GN rejilla 457
 GN soporte buffet 18,28,35,110,111,398
 GN soporte para buffet 18,225
 GN tabla de servir 166,297
 GN tapa 265,451-455,458
 granulado térmico 441

H

hormigón 92,104-105,117,303,313,349,351,478,479,546
 huevera 264,323

I

infusor de té, pinza con malla 535

J

jarra 130,131,132,136,138,139,486,524,528,529
 jarra de agua 130-132
 jarra de leche 324,339,528-530,532,533
 jarra de zumo 21,129-132,486
 jarra enfriadora 132
 jarra graduada 584,585
 jarra termo 138,139
 juego de cucharas medidoras 567

L

lámpara 25,356-387
 lámpara de mesa 356-387
 llavero enrollable 484
 luz de buffet 25-27

M

manoplas de panadero 591
 mantelín 330-337
 mantequera 322-323
 mantequillera 322
 marco pastelero 583
 marmita 435
 medidor jigger 496-497
 mejillonera 299
 mesa de servicio 22,167,301
 mini cuenco 115,177,184,211,254-256,258,278-280,283
 molde de cubitos de hielo esféricos 487
 molde de pizza 588
 molde para cubitos de hielo 487
 molinillo de pimienta 310-319
 molinillo de sal 310-319
 mortero 498
 moscow mule taza 506-508
 multibox 137,525

O

olla con tapa 82-85,442-445
 olla pequeña de servir 270,271
 organizador de bar 503
 organizador de mesas 20,90,173,294,320,321,354

P

pajás 505
 pala 490,582,589,590,592
 pala de hielo 490
 pala de pizza 589
 pala de tartas 553-555
 pala para harina 582,590
 paleta para servir 277
 paleta pastelera 574
 panera 404-406
 papel alimenticio 143,151,173,274,298,538
 papelera de sobremesa 352,354-355
 pedestal 18,21,128,129
 pelador reversible 571,572
 picadora de hielo 490
 pie porta champañera / vino 472,473
 pie porta vino 472,473
 pinchanotas 596
 pinza 80,491,560,562-569
 pinza bogavante 577
 pinza de emplatar 491,569
 pinza ensalada 80,560,562-568
 pinza espaguetis 560,563
 pinza exprime limón 495,597
 pinza multiuso 80,491,560,562-568
 pinza para aperitivos 563
 pinza para cubitos de hielo 491,562
 pinza para espárragos 564
 pinza para pasteles 567
 pinza universal 80,491,560,562-568
 pizarra 16,38,39,65,140,145,157,169,170,241,242,291,316
 placa calefactora 440
 placa de inducción 23,88,89,424,426-429,431,436,438,439
 plato 447,522,523
 plato de pizarra 144
 plato esmaltado 231
 plato melamina 187,190,194,197-200,203,206,207,209,213,216,219,222,224,230,231,245,252,257,262
 plato para el aperitivo 186,198,200,203,216,219,222,224,230,257,262,281
 plato para tartas 144,154,157,162,163,236,252
 polvoreador 302,305,306,318,319,580
 porcionador de pastel 554
 porta cubiertos 29,93-96,105,350-353,394,399,421,462-463
 porta cuenta 152,153,328,536,537,538,539
 porta menú 308,312,342-347
 porta vasos de cerveza 540
 portafichas 596
 porta-tarjetas 343-347
 portavelas antiviento 349
 posavasos acero inoxidable 328
 posavasos corcho 124,125,591
 posavasos melamina 20,116,119
 posavasos pizarra natural 143,316
 prensa de limón 495,597
 puente térmico 53,56,440
 pulverizador licores 501

Q	
quesera parmesano	309
R	
rack de copas	513
rack dispensador de cuencos	115
rebanador de queso	66,572
recipiente de ingredientes	502
recipiente de vidrio	21,78-81,108,114,115,117-120,124,125,128-130,287-289,307,321,501,513,533
recipiente para masa	466,590
recipiente para masa y bolas de pizza	466,590
recogemigas	327,539
reposa cuchara	259,465
reposa cucharas	259,465
resistencia	139,439,447
ribeteador de vasos	503
rizador	66,572
rotulador	18,37,170,348
rotulador de tiza	18,37,170,348

S	
sacacorchos	485
sacacorchos de camarero	485
salsera	56,77,325-327,531
samovar	446
señal de advertencia	594,611
servidor de ensalada	562-568,592
servilletero	17,90-92,105
servilleteros/aros	328
set de buffet refrigerado	39-42,44-47
set de crema y azúcar	339,530
set para fondue	329
set para ponche caliente	329
set para servir	193
set rolltop	28,32,42,45,144,157
snackbox	277
soplete de cocina para flambear	595
soporte	18,22,23,50,58,59,66,67,73,89,98-101,107,108,115,165,167,225,226,235,237,253,299,301,303,344,347,420,472,473,595
soporte a pedal	543
soporte campana	49
soporte cucuruchos	595
soporte de mesa para champanera	473
soporte de pretzels o salchichas	66
soporte para bandejas	22,167,301
soporte para botella de vino	486
soporte para enfriador de botellas	473
soporte para pastel	144,154,162-164,252,606
soporte para tablas de cortar	595
soporte platos	60,65,114,289
superbox	36-38

T	
tabla de corte	17,68-70
tabla de servir	50,58,59,62,68-74,166-171,174,273,291-295,297,414,538
tabla de sushi madera	166,297
tabla para cortar	17,50,68-72,74,167,502,538
tabla para el buffet	72-74
table de cocina	17,68-74
tamper	530
tamper de café	530
tapa	176,246,249,265,289,441,451-453,455,462,466,520,590,609-610
tapa hermética	289
tapete escurridor	503
tapón antipolvo	504
tapón vertedor	504
tarjetas	37,348
tarros gourmet	114,287-289
taza	290,446,447,506-513,519-523
taza de café	284,446,447,519-523
taza de cappuccino	522,523
taza de té	446,519-521
tenedor de carne	553,556,557
tenedor de ensalada	552,560,563-565,592
tenedor de servicio	553
termómetro	529
tetera	136,446,524
timbre	539,596
tin in tin shaker	492
tostadora	82-84,442-444
tubo de refrigeración	119
tubo enfriador para cubitos	117-119

V	
vaciador de melón redondo	570
vaso	124,514-518
vaso agitador	585
vaso coctelero	284
vaso de agua	514-518
vaso mezclador vertedor	500
vaso para servir	272-274,276
vaso reutilizable	519-521
vaso To-Go	520,521

vasos	124,125,284,506-522
vertedor	324,325,338,339,532,533
vertedor continuo	504
vertedores	324-325,338-339,504,531-533
vitrina de buffet	40-42,44
W	
Weck-botellas	286

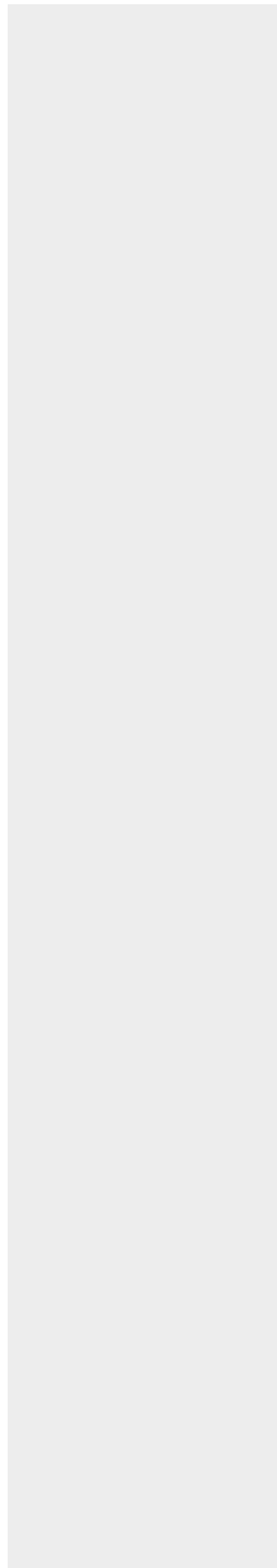

Weck-tarros 114,287-289

FRANÇAIS

item **pág.**

A	
accumulateur de froid	611
adaptateur	452
anneau coupe-gouttes mélamine	119,125
anneaux à serviettes	328
ardoise	16,38,39,65,140,145,157,169,170,241,242,291,316
articles en email	284-285,322
assiette de présentation	327
assiette email	231
assiette mélamine	187,190,194,197-200,203,206,207,209,213,216,219,222,224,230,231,245,252,257,262
assiette pour apéritif	186,198,200,203,216,219,222,224,230,257,262,281

B	
bac	33,35,135,467,475
bac en porcelaine	87,437
bac knock-out	450
bain-marie	441
barre aimantée pour couteaux	596
barre porte-bons	596
base bois	15,174,292,320
bassine à glace	135,475
Bento Box	224
béton	92,104-105,117,303,313,349,351,478,479,546

beurrer	322,323
boîte à ingrédients	502
boîte à lunch	467
boîte à œufs	446,581
boîte à pain pour le buffet	34,64,93,350,390,391-398,400-402,406-414,416,418-421
boîte à thés et infusions	137,525
boîte de buffet	31,75
boîte distributrice	35,81
boîte-repas	15-17,31,35-38,70,75,81,94,174,292,320,463
bol acier inox	57,150,270,273,274,276,281-283,415,419

bol aluminium	52,53,55,275
bol béton	101,104
bol bois	102,103,165,172,174,295,296
bol email	284,285,322
bol en verre	112-115,610
bol mélamine	28,45,183,185,187,188,189,191,193,195,197,198-201,203-205,207,209-217,219,221,223,224,226,227-236,241,243,245-251,253-258,261-263,299
bol mélangeur	284
bol mini	177,254,256
bol PET	175-178
bol récupérateur de capsules	484
bol réfrigéré	28,45-47
bordeur à verres	503
bouchon anti-poussières et anti-insectes	504
bouchon verseur	504
bouchons verseurs	324-325,338-339,504,531-533

boule à thé avec pince	535
bouteille	133,307
bouteille „store & pour“	501
bouteille de combustible liquide	433
bouteille d'huile et vinaigre	307
bouteille isotherme	138,139
bouteille verseuse souple	586,587
brosse lave	504,505
broyeur à glaçons	490

C	
caddy	20,90,173,294,320,321,354,503
caddy de table	20,90,173,294,320,321,354
caisson thermo	43
carafe	21,128-130,133
casserole	150,270,271
casserole à moules	299
cendrier	544-549
cendrier sur pied	549
cerce à gâteaux	583
cerce à mousse rond	583
chafing dish	86,87,424-434,437,439
chafing dish rolltop	432,434,441
châlumeau e cuisine	595
chariot	461
chariot de service	97,387,460,461
chauffe-plat	23,86-89,137,424-440,525
chauffe-thière	137,525
chevalets de table	346,348
chinois	578
cloche	34,73,146-148,154-156,164,196,

	237,252,398,402,413,600-609
cloche demi-sphère	327,539,596
cloche rolltop	28,32,34,39,40,41,42,44,45,73,74,140,144,157,252,397,441,602,603
coquetier	264,323
corbeille	404-406
corbeille acier inox	93,350,418-421
corbeille de buffet	34,396-397,401
corbeille de service	34,60-66,93,272,276,350,353,390,391,392-403,406-421

corbeille métal	60,63-65,407-417
corbeille polypropylène	34,353,390-403
corbeille pour baguettes	398,407,413,416
coupe-œufs	577
coupe-pâte	576,590
coupe-pizza	573,591
couteau à gateau	68,502,571,573,576
couteau à huîtres	573
couteau à lame ondulée	68
couteau à pain	68
couteau à tarte	554
couteau à tartiner	576
couteau cannelé	502,572
couteau cocktail	502
couteau de découpe	68,502,572
couteau tranche-fromage	66,572
couteau zesteur	570
couteau zesteur cannelé	571
couvercle	176,246,249,265,289,441,451-453,455,462,466,520,590,609-610
couvercle hermétique	289
couvert à salade	562-568,592
cuillère	178,193,220,259,260,261,290,
cuillère	500,552-561,567,592-594
cuillère à cocktail	500
cuillère à glace	567,595
cuillère à miel	593
cuillère à salade	259,552,554,555,559,560,563,565,592
cuillère à sauce	554,555,594
cuillère à spaghettis	560,561,563
cuillère de service	178,193,220,259-261,290,552-561,592-594
cuillère gourmet	290,594
cuillère party	178,220,260-262

D	
décanteur	21,130-133
décapsulateur	473,485
dénoyateur	571
dérouleur de film	597
distributeur de petits pains acier inox	49
distributeur à jus	20,30,116,117-121,122,124-127
distributeur à jus de fruit	30,121-123,126
distributeur à lait	30,126,127,339,528-530
distributeur de boisson isothermique	127
distributeur de boissons	20,116-127,139
distributeur de café acier inox	139,447
distributeur de céréales	29,106-109,129
distributeur de céréales acero inox	29,106-108
distributeur de confiture	115,581
distributeur de dosage	115,581
distributeur de snacks	321,513,533
distributeur de yogourt	115,581

E	
écumoire	559,561
égouttoir à friture	580
entonnoir	578,579
entonnoir à piston	578
étagère	19,22,58,60-63,65,145,235,417
étiquettes	37,62,77,348

F	
flacon pulvérisateur	308,501
flûte à champagne	518
forme à gateaux	583
fouet	577
fourchette à salade	552,560,563-565,592
fourchette à viande	553,556,557
fourchette de service	553
frisette	66,572

G	
gants de boulanger	591
GN bac	33,147,179,265,448-450,453-459
GN bac acier inoxydable	147,448-450
GN bac supérieur	16,17,35,38
GN base bois	15
GN bol	55,189,192,203,205,232,251
GN bol mélamine	189,192,203,205,232,251
GN chafing dish	425-427,430-434
GN cloche	34,73,146,147,196,239,398,402,413,441,600-604
GN corbeille	34,391,394,395,402,412,414
GN corbeille métal	412,414
GN corbeille polypropylène	34,391,394,395,402

GN couvercle	265,451-455,458
GN égouttoir	452,455
GN grille	457
GN planche de service	166,297
GN plateau 32,33,38,54,146,147,148,179,182,186,190,196,198,202,205,206,208,218,225,229,238-241,247,249,251,263,457,459	
GN plateau acier inox	32,146,147,148
GN plateau aluminium	54
GN plateau ardoise naturelle	16,38,140,141
GN plateau buffet acier inox	40,41
GN plateau mélamine	38,182,186,190,196,198,202,205,206,208,209,218,225,229,238-241,244,247,249,251,263
GN plateau party	158
GN plateau porcelaine	33,457
GN présentoir buffet	18,28,35,110,111,225,398
GN présentoir buffet en escalier	110,111
GN range couverts	35,94,96,394,457,462,463
GN support buffet	18,35
gobelet	124,290,506-521
gobelet à apéritif	272-274,276
gobelet à eau	514-518
gobelet à thé	446,519-521
gobelets	124,125,284,506-522
gourde	526,527
gravier thermique	441
H	
housse isotherme	486
J	
jeu de cuillère à mesure	567
L	
lampe	25,356-387
lampe de buffet	25-27
lampe de table	356-387
louche	552,556,557,560,561
louche de service	554,555
M	
marmite	435
marmite avec couvercle	82-85,442-445
marmite petite de servir	270,271
marqueur à la craie liquide	18,37,170,348
mesure jigger	496-497
mini bol	115,177,184,211,254-256,258,278-280,283
moscow mule gobelet	506-508
moule à boule ronde simple	570
moule à glaçons	487
moule à glaçons en boules	487
moule à pizza	588
moulin à poivre	310-319
moulin à sel	310-319
multibox	137,525
O	
organisateur „bar caddy“	503
organisateur de table	20,90,173,294,320,321,354
P	
pailles	505
panier à œufs	65,403,407
panier en corde au crochet	406
panier pour le service sur table	272
panneau d'avertissement	594,611
papier alimentaire	143,151,173,274,298,538
pare-haleïne	18,48,49,66
passoire	578,580
peleur	571,572
pelle	490,582,589,590,592
pelle à farine	582,590
pelle à gâteau	553-555
pelle à glaçons	490
pelle à pizza	589
petits chevalets de buffet	37,348
pichet	130-132,134,136,138,139,486,524,528,529
pichet à café	138,139,528,529
pichet à eau	130-132
pichet à jus de fruit	21,129-132,486
pichet à lait	324,339,528-530,532,533
pichet gradué	584,585
pichet rafraîchisseur	132
piéd pour seau à champagne / vin	472,473
piéd pour seau à vin	472,473
pilon à café	530
pilon muddler	498
pince	80,491,560,562-569
pince à apéritif	563
pince à asperges	564
pince à dresser	491,569
pince à gâteaux	563-567
pince à glaçons	491,562
pince à homard	577
pince à salade	80,560,562-568
pince à spaghetti	560,563

pince multifonctionnelle	80,562,563,566,568
pince multi-usage	80,491,560,562-568
pince presse citron	495,597
pince universelle	80,491,560,562-568
pique-bons	596
pissette p. liqueurs	501
planche à découper	17,50,68-72,74,167,502,538
planche à découper buffet	72-74
planche de cuisine	17,68-74
planche de service	50,58,59,62,68-74,166-171,174,273,291-295,297,414,538
plaque à induction	23,88,89,424,426-429,431,436,438,439
plaque à pâtisserie	457,582
plaque chauffante	440
plat à four	85,445
plat à gâteau acier inox	154,163
plat à gâteau bois	162
plat à gâteau mélamine	163,187,236,252
plat à sauter	268,269,271
plat ardoise naturelle	16,38,140,141,142,143,144,145,316
plat de service / plat à tarte ardoise	144
plat pour la table	150,269-271
plateau 22,28,32,33,38-45,54,63,70,71,103,142,146-157,159-161,166,167,179,182,186,187,190,196,198,200-202,205,206,208,209,213,216,218-220,225,227,229,230,236,238-244,247,249,251,252,263,292,297,298,300,301,328,393,417,457,459,530,536,537-542,604	
plateau à gâteaux	144,154,157,162,163,236,252
plateau acier inox	32,33,39-44,144,154,155,157,263
plateau bois	22,32,44,63,73,103,156,166,167,292,297,298,301,417
plateau de service	16,33,38,140-144,154,157-158,187,236,239,242,263
plateau bois 22,32,44,63,73,103,156,166,167,2,92,297,298,301,417	
plateau de service	16,33,38,140-144,154,157-158,187,236,239,242,263
plateau feuille mélamine	514,223
plateau mélamine	28,63,71,142,182,186,187,190,196,198,200-202,205,206,208,209,213,216,218-220,225,227,229,230,236,238,244,247,249,251,252,263,538
plateau party	158
plateau self-service et snacks	159,542
plateau sous-verre acier inox	328
plateau sous-verre mélamine	20,116,119
plateau sushi mélamine	198,200,213
plateaux réfrigérés	32,44
plucheur droitier/gaucher	571,572
pochette à serviettes	336
pochette couverts	336
podium	18,21,128,129
pompe de dosage	581
pont thermique	53,56,440
porte verres à bière	540
porte-addition	152,153,328,536,537,538,539
porte-bols	115
porte-bougies anti-vent	349
porte-bouteille à vin	486
porte-cartes	308,312,342-347
porte-cartes de table	343-347
porte-clés avec câble à enroulement	484
porte-épices	302-308,312
porte-seau à champagne	473
porte-serviettes	17,90-92,105
pose-cuillère	259,465
pot	78-81
pot à épices	302,305,306,318,319,580
pot à sauce	56,77
pot de moutarde	304
pot verseur universel	339,533
poubelle à pédale	543
poubelle de table	352,354-355
présentoir	332
présentoir à assiettes	60,65,114,289
présentoir à gâteau	163
présentoir à gâteaux	144,154,162-164,252,606
présentoir à sandwiches	51,277
présentoir buffet	18,31,37,64,66,67,73,98-101,108,110-114,165,225-226,235,289,299,398
présentoir buffet acier inox	226
présentoir buffet bois	67,101,108
présentoir buffet en escalier	110-112
présentoir buffet froid	28,39-42,44-47,140
présentoir buffet métal	18,73,98,99,100,165,225,235,299
presse citron	495,597
presse-citron	495,597

R	
rack porte-verres	513
rack pour planches à découper	595
rafraîchisseur	484
rafraîchisseur de bouteilles	56,105,134,283,470-484,486
rafraîchisseur de caviar	157,300
ramasse-miettes	327,539
ramequin	177,184,211,255-256,258,278,279,280,283
range couverts	29,93-96,105,350-353,394,399,421,462-463
réipient à pâte	466,590
réipient à pâte et boules à pizza	466,590
réipient bain-marie	579
réipient en verre	21,78-81,108,114,115,117-120,124,125,128-130,287,289,307,321,501,513,533
refroidisseur pour bouteilles	469-484
repose-cuillère	259,465
résistance	139,439,447
rôtissoire	82-84,442-444
S	
samovar	446
saucière	325-327,531
saupoudreuse à épices	318,319,580
seau	276,489-490
seau à champagne	135,470-474,476,477,483,490
seau à glaçons	35,488-489
seau à glaçons isothermique	489-490
seau à vin	135,470-474,477,483
service à fondue	329
service à parmesan	309
service à punch	329
set apéritif	302-309,312
set de service	193
set de table	330-337
set lait et sucre	339,530
set rolltop	28,32,42,45,144,157
set thermo	45
shaker	492-494,512
snackbox	277
sonnette	539,596
soucoupes ardoise naturelle	143,316
soucoupes liège	124,125,591
sous-tasse	447,522,523
spatule	553,557-559,561,574,575
spatule à pâte	575,576
spatule coudée spéciale grill	575,576
spatule pâtisseries	574
station à induction	23,88,89,436,438
station de charge	25,383,386
station de cuisson mobile	23,88,89,436,438
station de panure	597
station pain	70
stylo	18,37,170,348
sucrier	340,341,534,535
superbox	36-38
support	18,22,23,50,58,59,66,67,73,89,98-101,107,108,115,165,167,225,226,235,237,253,299,301,303,344,347,420,472,473,595
support à bretzel ou à saucissons	66
support à cornets	595
support cloche	49
support de plateau	22,167,301
support multiple	76
support pour refroidisseur de bouteilles	473
sushiboard en bois	166,297
T	
table de service	22,167,301
tamis	130,131,499,502,535,549,578,579
tamis cocktail	499,502,578
tamper	530
tapis antidérapant	17
tapis de bar	503
tapis égouttoir	503
tasse	446,447,519,520,522,523
tasse à café	284,446,447,519-523
tasse à cappuccino	523
tasse à espresso	522
tasse à remuer	585
tasse réutilisable	519-521
tasse To-Go	520,521
théière	136,446,524
thermomètre	529
tin in tin shaker	492
tire-bouchons	485
truelle de service	277
tube de refroidissement	119
tube pour glaçons	117-119
V	
vase soliflor	349
verre à vin	518

verre mélangeur	500
verres gourmet	114,287-289
verseur à crème	324,325,336,339,531-533
verseurs continus	504
vitrine de buffet	40-42,44
W	
Weck-bouteilles	286
Weck-verrines	114,287-289

Enjoy!





Buffet & Display

5 STARS	82
BEVERAGE DISPENSERS	116
BRIDGE	28
CARAFES	128
CEREAL DISPENSERS	106
COOLING DISPLAYS	39
CUTTING BOARDS	68
ELEMENT	104
FRAMES	32
FRIENDLY	175
FROSTFIRE	52
JARS	78
MANGO	102
MULTI RACK	76
NAPKIN HOLDERS	90
NATURAL SLATE	140
OLIVE	171
ORBIT	86
PERFECTO	58
SERVING BOARDS WOOD	168
SIMPLY WOOD	166
SPHERE	57
SUPERBOX	36
TRAYS STAINLESS STEEL	146
VALO	14
VALUMO	24

VALO



Auf Gastronom-Größen basierende, stapelbare Boxen und Tablett bilden das Herzstück des innovativen und erweiterbaren Buffetsystems, das zahlreiche Kombinationsmöglichkeiten nicht nur innerhalb des VALO Sortiments zulässt, sondern auch mit vielen weiteren APS Produkten. Geeignet für die vielseitige Speisenpräsentation ist VALO somit ein universelles System, das mit seinem umfangreichen und multifunktionalen Zubehörsortiment Lösungen für alle Anforderungen bietet.

Stackable boxes and trays based on the gastronorm sizes form the centrepiece of the innovative and expandable buffet system, which allows numerous possible combinations not only within the VALO range, but also with many other APS products. Suitable for versatile food presentation, VALO is thus a universal system that offers solutions for all requirements with its extensive and multifunctional range of accessories.

Las cajas y bandejas apilables basadas en tamaños gastronorm forman el núcleo del innovador y ampliable sistema de buffet, que permite numerosas posibilidades de combinación no sólo dentro de la gama VALO, sino también con muchos otros productos APS. Adecuado para la presentación versátil de fiambresas, VALO es, por tanto, un sistema universal que ofrece soluciones para todos los requisitos gracias a su amplia y multifuncional gama de accesorios.

Des boîtes et des plateaux empilables, basés sur les dimensions gastronorm, constituent le cœur de ce système de buffet innovant et extensible, qui permet de nombreuses combinaisons non seulement au sein de la gamme VALO, mais aussi avec de nombreux autres produits APS. VALO est donc un système universel qui offre des solutions à toutes les exigences grâce à sa vaste gamme d'accessoires multifonctionnels.



Kombinierbar mit VALO Schieferplatten und vielen anderen Komponenten in Gastronom-Größen.

Puede combinarse con las bandejas de pizarra VALO y muchos otros componentes en tamaños Gastronom.

**GN 1/1 Holzbox**

GN 1/1 woodbox
GN 1/1 caja madera
GN 1/1 base bois



Eichenholz (geölt) / oak wood (oiled) / madera de roble (aceitada) / chêne (huilé)

	cm	↑ cm	GN	€
14000	53 x 32,5	4,5	1/1	76,00
14001	53 x 32,5	8,5	1/1	92,00
14002	53 x 32,5	16,5	1/1	136,00

**GN 1/2 Holzbox**

GN 1/2 woodbox
GN 1/2 caja madera
GN 1/2 base bois



Eichenholz (geölt) / oak wood (oiled) / madera de roble (aceitada) / chêne (huilé)

	cm	↑ cm	GN	€
14003	32,5 x 26,5	4,5	1/2	54,00
14004	32,5 x 26,5	8,5	1/2	66,00
14005	32,5 x 26,5	16,5	1/2	92,00

**GN 1/3 Holzbox**

GN 1/3 woodbox
GN 1/3 caja madera
GN 1/3 base bois



Eichenholz (geölt) / oak wood (oiled) / madera de roble (aceitada) / chêne (huilé)

	cm	↑ cm	GN	€
14006	32,5 x 17,5	4,5	1/3	46,00
14007	32,5 x 17,5	8,5	1/3	54,00

**GN 2/4 Holzbox**

GN 2/4 woodbox
GN 2/4 caja madera
GN 2/4 base bois



Eichenholz (geölt) / oak wood (oiled) / madera de roble (aceitada) / chêne (huilé)

	cm	↑ cm	GN	€
14008	53 x 16,2	4,5	2/4	60,00
14009	53 x 16,2	8,5	2/4	71,00

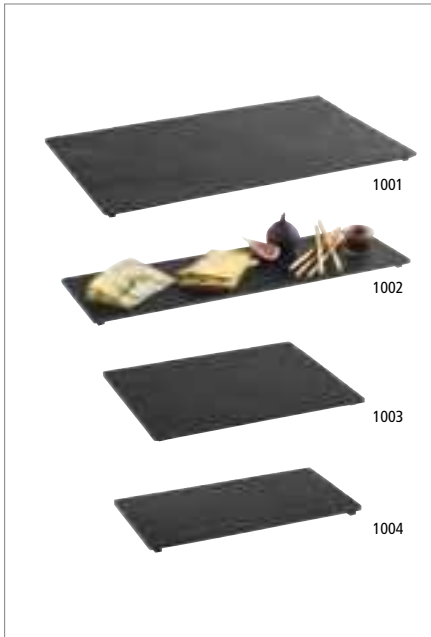

GN Naturschieferplatte

GN natural slate tray
GN bandeja de pizarra natural
GN plat ardoise naturelle



Schieferplatte mit möbelschonenden Füßchen, gerade Kanten

slate top with furniture-friendly feet, straight edges
encimera de pizarra con patas aptas para muebles, bordes rectos
plateau en ardoise avec pieds qui protègent les meubles, bords rectilignes

	cm	✂ mm	GN	€
1001	53 x 32,5	6 - 9	1/1	16,40
1002	53 x 16,2	6 - 9	2/4	6,80
1003	32,5 x 26,5	6 - 9	1/2	9,20
1004	32,5 x 17,6	6 - 9	1/3	5,60



GN Einsatz „VALO“

GN insert
GN bandeja
GN bac supérieur



passender Einsatz zu VALO GN Holzboxen, ideal zum Befüllen mit Crushed Eis

suitable insert for VALO GN wooden boxes, ideal for filling with crushed ice
bandeja para cajas de madera VALO GN, ideal para rellenar con hielo picado
bac supérieur pour caisses en bois VALO GN, idéal pour le remplissage avec de la glace pilée

	cm	↑ cm	GN	fits to	€
14041 <small>NEW</small>	51,5 x 31	6	1/1	14001	32,00
14036	51,5 x 31	14	1/1	14002	35,00
14042 <small>NEW</small>	31,0 x 25	6	1/2	14004	23,00
14037	31,0 x 25	14	1/2	14005	26,00



Einsatz für GN 1/1 Holzbox

insert for GN 1/1 woodbox
separador para GN 1/1 caja madera
insert pour GN 1/1 base bois



Einsatz mit Fächern 9,5 x 9,5 cm

insert with compartments 9,5 x 9,5 cm
bandeja con compartimentos 9,5 x 9,5 cm
insert avec compartiments 9,5 x 9,5 cm

	cm	↑ cm	fits to	€
14021	50,5 x 30	6	14001	36,00



Einsatz für GN 1/2 Holzbox, 2er Set
 insert for GN 1/2 woodbox, 2 pcs
 separador para GN 1/2 caja madera, set de 2
 insert pour GN 1/2 base bois, set de 2

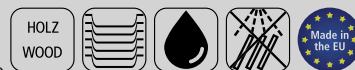

Einsatz mit drei Fächern
 insert with 3 compartments
 bandeja con 3 compartimentos
 insert avec 3 compartiments

	cm	↑ cm	fits to	€
14022	24 x 10,5	6	14004	21,00

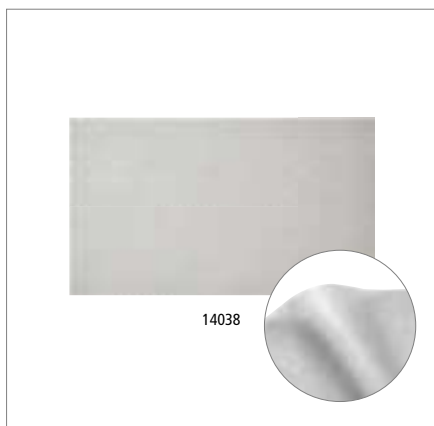

Antirutschmatte
 anti-slip mat
 alfombra antideslizante
 tapis antidérapant



Passend für GN 1/1, GN 1/2, GN 2/4
 suitable for GN 1/1, GN 1/2, GN 2/4
 decuado para GN 1/1, GN 1/2, GN 2/4
 convient pour GN 1/1, GN 1/2, GN 2/4

	fits to	€
14038	GN 1/1	10,00
14039	GN 1/2	8,00
14040	GN 2/4	8,00

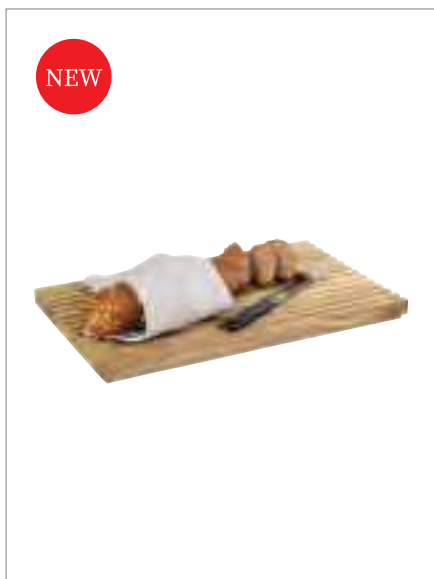

Brottschneidebrett „VALO“
 cutting board
 tabla de cortar
 planche à découper



Eichenholz (geölt), mit Antirutsch-Füßchen
 oak wood (oiled), with non-slip feet
 madera de roble (aceitada), con pies antideslizantes
 bois de chêne (huilé), avec pieds antidérapants

	cm	↑ cm	GN	€
00764	53 x 32,5	3,5	1/1	100,00

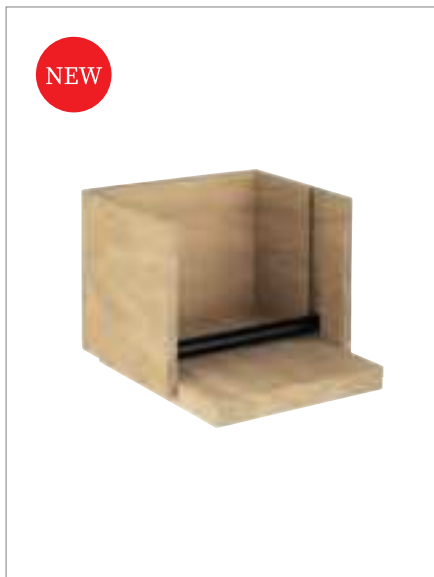

Serviettenhalter „VALO“
 napkin holder
 servilletero
 porte-serviettes



Eichenholz (geölt), für ca. 100 Servietten mit 1/4 Falz, inklusive Beschwerer
 oak wood (oiled), for approx. 100 napkins with 1/4 fold, including weight
 madera de roble (aceitada), para aprox. 100 servilletas con 1/4 de pliegue, con barra de contrapeso
 bois du chêne (huilé), pour env. 100 serviettes pliées en 1/4, avec barre de contrepoids

	cm	↑ cm	€
14092	19 x 19	16	59,00



stapelbar
 stackable

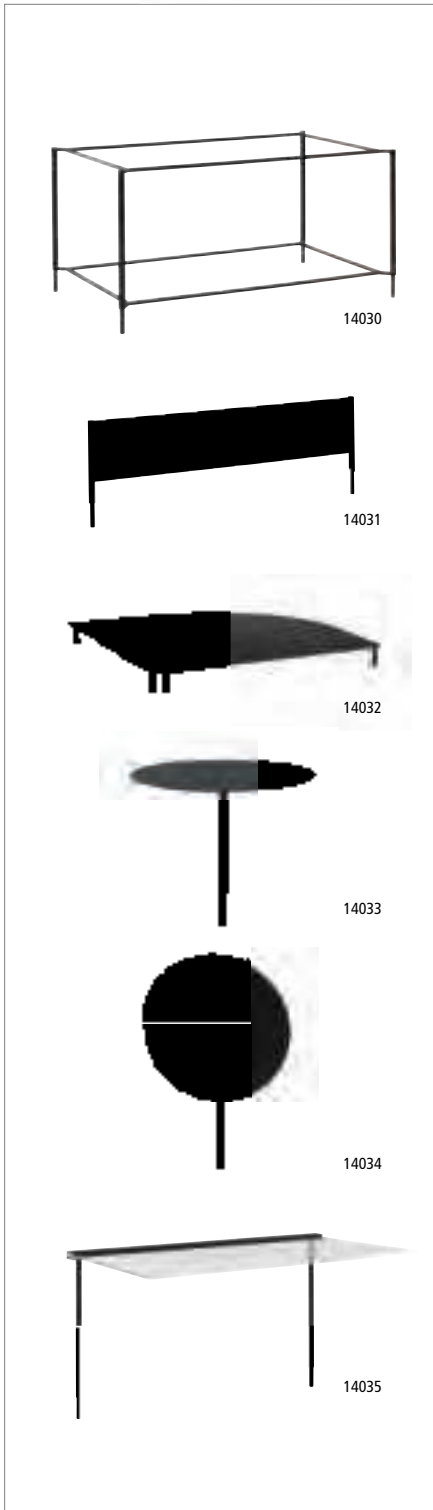

GN Buffetständer

GN buffet stand + Zubehör
GN soporte para buffet
GN présentoir buffet



- Multifunktionaler stapelbarer Buffetständer aus pulverbeschichtetem Metall
- Stecktafel
- Eckverbindung
- Podest und Schild
- Hygieneschutz

- multifunctional stackable buffet stand made of powder-coated metal
- pegboard
- corner connection
- pedestal and shield
- hygienic protection

- soporte multifuncional apilable para bufé fabricado en metal con recubrimiento en polvo
- tablero de anuncios
- conexión de esquina
- pedestal y escudo
- protección higiénica

- support de buffet multifonctionnel empilable en métal revêtu par poudre
- panneau d'affichage
- raccord d'angle
- plateforme et bouclier
- protection hygiénique

	cm	↑ cm	€
14030	57 x 37	28,5	150,00
14031	57 x 1	19,5	38,00
14032	39 x 39	3	56,00
14033	∅ 25	20,5	30,00
14034	∅ 25	33	30,00
14035	60,5 x 36,5	33,5	130,00

Kreide-Marker, Stärke 2 mm, 2er Set

chalk marker, 2 pcs.
rotulador de tiza, set de 2
marqueur a la craie liquide, set de 2



	∅ cm	↑ cm	Farbe / Colour	pcs.	€ / set
71490	1	13	White	2	6,20



NEW

**Etagère, 2-stufig „VALO“**

2-tier tray
bandeja 2 alturas
étagère carré 2 hauteurs



Eichenholz (geölt), untere Ebene 52 x 26,5 cm, obere Ebene 52 x 16 cm

oak wood (oiled), lower level 52 x 26,5 cm, upper level 52 x 16 cm

madera de roble (aceitada), nivel inferior 52 x 26,5 cm, nivel superior 52 x 16 cm

bois du chêne (huilé), niveau inférieur 52 x 26,5 cm, niveau supérieur 52 x 16 cm

	cm	↑ cm	€
14020	54 x 26,5	26,5	189,00



angewinkelte Innenbox
für ideale Präsentation
angled inner box
for ideal presentation



14012

Etagère, 3-stufig

3-tier tray
bandeja 3 alturas
étagère carré 3 hauteurs



Gestell aus Eichenholz (geölt)

oak wood frame (oiled)

marco de madera de roble (aceitada)

structure en bois du chêne (huilé)

	cm	↑ cm	fits to	€
14012	55,5 x 32,5	64	GN 1/1, 2/4	248,00



14010



14011

Etagère, 2-stufig

2-tier tray
bandeja 2 alturas
étagère carré 2 hauteurs



Gestell aus Eichenholz (geölt)

oak wood frame (oiled)

marco de madera de roble (aceitada)

structure en bois du chêne (huilé)

	cm	↑ cm	fits to	€
14010	35 x 26,5	44,5	GN 1/2, 1/3	164,00
14011	55,5 x 26,5	44,5	GN 2/4	190,00

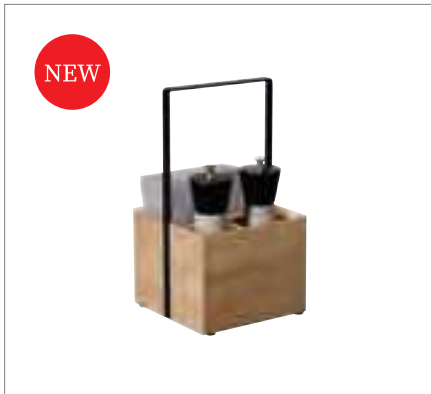

NEW

Table Caddy „VALO“

table caddy
caddy de mesa
caddy de table



Eichenholz (geölt), 3 Fächer, mit Antirutsch-Füßchen
oak wood (oiled), 3 compartments, with non-slip feet
madera de roble (aceitada), 3 compartimentos, con pies antideslizantes
bois de chêne (huilé), 3 compartiments, avec pieds antidérapants

	cm	↑ cm	€
14090	15 x 15	28	66,00



NEW

Table Caddy „VALO“

table caddy
caddy de mesa
caddy de table



Eichenholz (geölt), 3 Fächer, mit Antirutsch-Füßchen
oak wood (oiled), 3 compartments, with non-slip feet
madera de roble (aceitada), 3 compartimentos, con pies antideslizantes
bois de chêne (huilé), 3 compartiments, avec pieds antidérapants

	cm	↑ cm	€
14091	15 x 15	31	89,00



3,8 ltr.
14025

7 ltr.
14015

2 x 7 ltr.
14016

Getränkespender „VALO“

beverage dispenser
dispensador de bebidas
distributeur de boissons



Eichenholz (wasserdicht lackiert), Zapfhahn aus Edelstahl, Untersetzer aus Melamin, Bodenplatte (Gläsertablett) herausnehmbar
oak wood (waterproof lacquered), stainless steel tap, melamine coaster, removeable base plate

madera de roble (lacado impermeable), grifo de acero inoxidable, posavasos de melamina, placa base extraíble

bois de chêne (vernis imperméable), robinet en acier inox, dessous de verre en mélamine, plaque de fond amovible

	cm	↑ cm	ltr.	€
14025 NEW	18,0 x 18	41,0	3,8	200,00
14015	21,0 x 21	46,5	7	240,00
14016	43,5 x 21	46,5	2 x 7	390,00

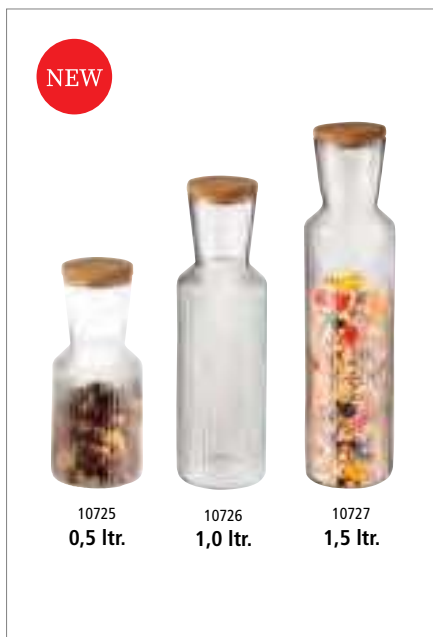
**Glaskaraffe „LINES“**

glass carafe
jarra de vidrio
carafe en verre

GLAS
GLASS

KORK
CORK

ideal für Cerealien, Säfte oder Milch, Deckel aus Kork

ideal for cereals, juices or milk, cork lid

ideal para cereales, zumos o leche, tapa de corcho

idéal pour les céréales, les jus de fruits ou le lait, couvercle en liège

	Ø cm	↑ cm	ltr.	fits to	€
10725	9	19,5	0,5	14023	16,00
10726	9	27,5	1,0	14023	23,00
10727	9	35,0	1,5	14023	24,00

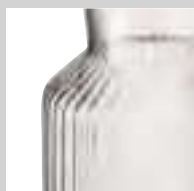
**3er-Podest für Glaskaraffen „VALO“**

podest for 3 glass carafes
pedestal de 3 para jarra de vidrio
podium pour 3 pichets en verre

HOLZ
WOOD



Eichenholz (geölt), ideal für eine stets geordnete Präsentation am Buffet

oak wood (oiled), ideal for a constantly organised presentation at the buffet

madera de roble (aceitada), ideal para una presentación constantemente organizada en el bufé

chêne (huilé), idéal pour une présentation toujours ordonnée au buffet

	cm	↑ cm	fits to	€
14023	41 x 16	12	17025, 17026, 17027	49,00

**Glaskaraffe „LINES“**

glass carafe
jarra de vidrio
carafe en verre

GLAS
GLASS

KORK
CORK

ideal für Cerealien, Säfte oder Milch, Deckel aus Kork

ideal for cereals, juices or milk, cork lid

ideal para cereales, zumos o leche, tapa de corcho

idéal pour les céréales, les jus de fruits ou le lait, couvercle en liège

	Ø cm	↑ cm	ltr.	fits to	€
10738	8	28	0,75	14019	22,00

**1er-Podest für Glaskaraffen „VALO“**

podest for 1 glass carafes
pedestal de 1 para jarra de vidrio
podium pour 1 pichets en verre

HOLZ
WOOD



Eichenholz (geölt), ideal für eine stets geordnete Präsentation am Buffet

oak wood (oiled), ideal for a constantly organised presentation at the buffet

madera de roble (aceitada), ideal para una presentación constantemente organizada en el bufé

chêne (huilé), idéal pour une présentation toujours ordonnée au buffet

	cm	↑ cm	fits to	€
14019	15 x 15	12	10738	15,00



Etagère, 2+3-stufig, rund
 2+3-tier tray, round
 bandeja 2+3 alturas, en torno a
 étagère carré 2+3 hauteurs, rond

Gestell aus Eichenholz (geölt)
 oak wood frame (oiled)
 marco de madera de roble (aceitada)
 structure en bois du chêne (huilé)

HOLZ WOOD NON SLIP FEET WATER RESISTANT MADE IN THE EU

	Ø cm	↑ cm		€
14013	30	28		68,00
14014	30	42		87,00



Serviertablett „VALO“
 tray
 bandeja
 plateau

Eichenholz (geölt), Innenmaß 56 x 36 cm
 oak wood (oiled), inside dimensions 56 x 36 cm
 madera de roble (aceitada), dimensiones interiores 56 x 36 cm
 bois du chêne (huilé), dimensions intérieures 56 x 36 cm

HOLZ WOOD COLLAPSIBLE WATER RESISTANT MADE IN THE EU

	cm	↑ cm	fits to	€
14060	60 x 40	3	14061	82,00

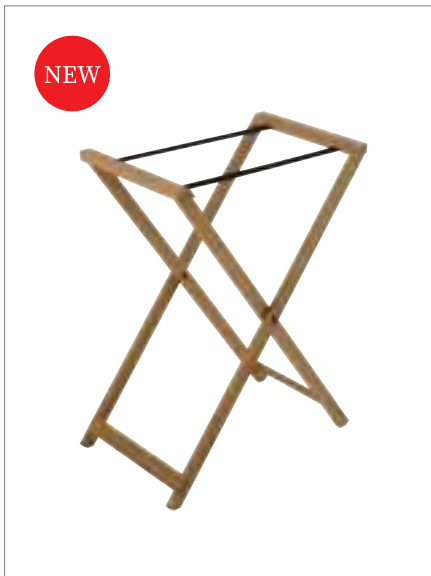

Tablettständer „VALO“
 tray stand
 soporte para bandejas
 support de plateau

Eichenholz (geölt), zusammenklappbar
 oak wood (oiled), collapsible
 madera de roble (aceitada), plegable
 bois du chêne (huilé), pliable

HOLZ WOOD WATER RESISTANT MADE IN THE EU

	cm	↑ cm	fits to	€
14061	56 x 35,5	75	14060	130,00

mit Magnetbefestigung
 with magnetic attachment



Kochplatte Ø 24 cm
induction station Ø 24 cm

4 tlg.
4 pcs.



12276



12272



12295

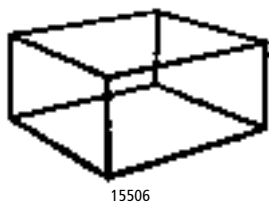

15506

Induktionsstation, 4-tlg. Set „VALO“

induction station, 4 pcs.
estación de inducción, set de 4
station d'induction, set de 4



4 teiliges Set:

- 1 Induktionskochplatte mit Regler (Ø 24 cm, 900 Watt)
- 1 Metallständer schwarz
- 1 Rahmen aus Eiche (wasserfest lackiert)
- 1 Edelstahlrahmen

4 pcs. set:

- 1 induction hotplate with controller (Ø 24 cm, 900 watt)
- 1 metal stand black
- 1 frame made of oak (water-resistant coated)
- 1 stainless steel frame

set de 4:

- 1 placa de inducción con regulador (Ø 24 cm, 900 vatios)
- 1 soporte de metal negro
- 1 caja de roble (con recubrimiento resistente al agua)
- 1 marco de acero inoxidable

set de 4:

- 1 plaque d'induction avec température réglable (Ø 24 cm, 900 watts)
- 1 support métallique noir
- 1 cadre en chêne (verni résistant à l'eau)
- 1 cadre en acier inox

	cm	↑ cm	€
12275	35,4 x 32,5	19	224,00



passendes Chafing Dish Set 12339
suitable chafing dish set 12339

Ersatzteile / replacement parts / piezas de repuesto / pièces de rechange

	cm	↑ cm		€
12276	35,4 x 32,5	8,5	Holzrahmen / wooden frame	72,00
12272	29,5 x 26,5	1	Edelstahlrahmen / stainless steel frame	22,00
12295	Ø 24	-	900 Watt Induktionskochplatte / induction plate	139,00
15506	35,4 x 32,5	17,6	Buffetständer schwarz / buffet stand black	22,80

Induktionsstation, 2-tlg. Set „VALO“

Induction station, 2-piece set
Estación de inducción, juego de 2 piezas
Station à induction, set de 2 pièces



Set, bestehend aus Induktionkochplatte 2000 Watt, inklusive Kabel-Fernbedienung, Leistung in Stufen regelbar, Rahmen aus Eichenholz (wasserfest lackiert)

set consists of induction hotplate 2000 Watt, cable remote control, power adjustable in steps, frame made of oak (waterproof lacquered)

set, compuesto por placa de inducción 2000 Watt, incluye mando a distancia por cable, potencia regulable en pasos, madera de roble (lacado impermeable)

set, composé d'une plaque de cuisson à induction 2000 watts, télécommande filaire incluse, puissance réglable par paliers, bois de chêne (verniss imperméable)

	cm	↑ cm		€
14050	39 x 39	10	2000 W	280,00

NEW

VALUMO



VALUMO – Ihr Buffet, perfekt beleuchtet. Kabellos. Flexibel. Stilvoll.

VALUMO – Your buffet, perfectly illuminated.
Wireless. Flexible. Stylish.

Das Buffet-Beleuchtungssystem VALUMO überzeugt durch seine Kombination aus modernem Design und praktischer Funktionalität. Es besteht aus dem Leuchtkopf Nr. 17090 und vier flexiblen Halterungen. Dank der Magnetkugelfestigung lässt sich der Leuchtkopf nahezu 360 Grad drehen, um das Licht präzise auszurichten.

Die Steuerung erfolgt ganz bequem über eine Fernbedienung oder direkt über den Touch-Button am Gehäuse. Mit Kaltweiß, Warmweiß und RGB-Farben bietet VALUMO vielfältige Beleuchtungsoptionen für jede Stimmung und jeden Anlass.

Der Leuchtkopf wird über die mitgelieferte Ladeplatte oder die optional erhältlichen Mehrfach-Ladeplatten aufgeladen – eine Lösung, die kabellosen Komfort und maximale Flexibilität garantiert.

VALUMO ergänzt das Buffetsystem VALO ideal, ermöglicht eine nahtlose Integration und kann flexibel zusammengestellt werden, um individuellen Anforderungen gerecht zu werden.

The VALUMO buffet lighting system impresses with its combination of modern design and practical functionality. It consists of the light head no. 17090 and four flexible brackets. Thanks to the magnetic ball attachment, the light head can be rotated almost 360 degrees to precisely direct the light.

It can be conveniently controlled via a remote control or directly via the touch button on the housing. With cool white, warm white and RGB colours, VALUMO offers a wide range of lighting options for every mood and occasion.

The light head is charged via the supplied charging plate or the optionally available multiple charging plates - a solution that guarantees wireless convenience and maximum flexibility.

VALUMO is the ideal complement to the VALO buffet system, enables seamless integration and can be flexibly combined to meet individual requirements.



Magnetkugelfestigung
magnetic ball mounting



nahezu 360 Grad drehbar
almost 360 degrees rotatable



Ladestation
charging station



Leuchtkopf
light head
cabezal iluminado
tête lumineuse



inklusive Ladestation, USB Ladekabel (ohne Netzteil), Fernbedienung inklusive Batterie
charging station included, USB charging cable (without mains adapter), remote control including battery
con estación de carga, cable de carga USB (sin adaptador de red), mando a distancia inclusivo batería
avec station de charge, câble de charge USB (sans bloc d'alimentation), télécommande avec batterie

	∅ cm	↑ cm	€
17090	7,5	4,8	28,00



Standfuß inklusive Stab „VALUMO“

stand including rod
soporte con varilla
ped de support, tige incluse

bestehend aus 3 Elementen: Standfuß mit Stab, Erweiterungsstab, Magnetkugel
consisting of 3 elements: stand with rod, extension rod, magnetic sphere
consta de 3 elementos: soporte con varilla, varilla de prolongación, esfera magnética
composé de 3 éléments : pied avec tige, tige de rallonge, boule magnétique



	∅ cm	↑ cm	€
17092	14	31 - 51	19,00

Lieferung ohne Leuchtkopf Nr. 17090
delivery without light head no. 17090

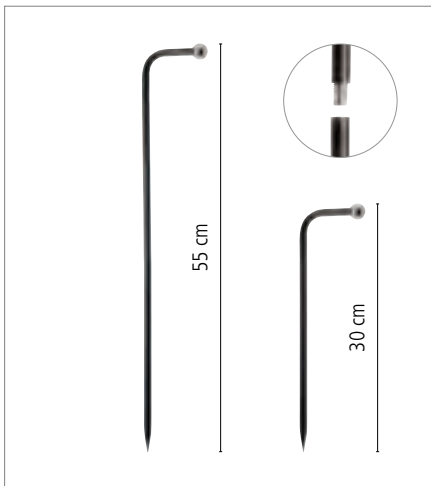

Stab zum Stecken „VALUMO“

stick for insertion
varilla de inserción
tige à enfoncer

bestehend aus 3 Elementen: Spitze (24 cm), Erweiterungsstab, Magnetkugel
consisting of 3 elements: tip (24 cm), extension rod, magnetic sphere
consta de 3 elementos: punta (24 cm), alargadera, esfera magnética
composé de 3 éléments : pointe (24 cm), barre d'extension, boule magnétique



	∅ cm	↑ cm	fits to	€
17093	0,9	30 - 55	14030 VALO	9,00

Lieferung ohne Leuchtkopf Nr. 17090
delivery without light head no. 17090

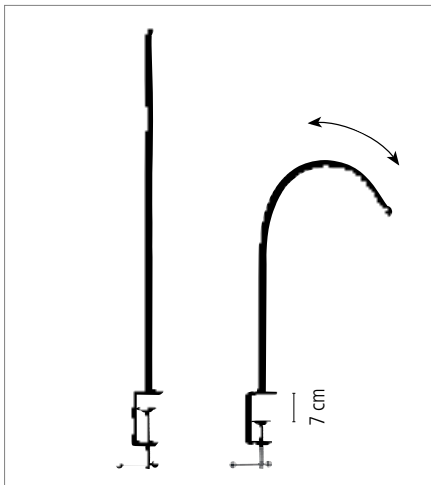

Schraubklammer mit flexiblem Arm „VALUMO“

screw clamp with flexible arm
abrazadera de tornillo con brazo flexible
pince à visser avec bras flexible

zum Befestigen an Buffetelementen oder Tischplatten, mit flexiblem Arm
for attachment to buffet elements or table tops, with flexible arm
para fijar a elementos de buffet o tableros de mesa, con brazo flexible
à fixer sur des éléments de buffet ou des plateaux de table, avec bras flexible



	cm	↑ cm	€
17094	4,5 x 4	64	19,00

Lieferung ohne Leuchtkopf Nr. 17090
delivery without light head no. 17090

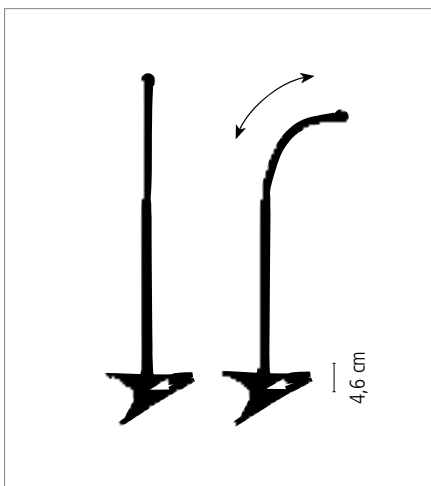

Klammer mit flexiblem Arm „VALUMO“

clamp with flexible arm
pinza con brazo flexible
agrafe avec bras flexible

zum einfachen Befestigen an Buffetelementen oder Tischplatten, mit flexiblem Arm
for easy attachment to buffet elements or table tops, with flexible arm
para fijar fácilmente a elementos de bufé o tableros de mesa, con brazo flexible
pour une fixation facile sur des éléments de buffet ou des plateaux de table, avec bras flexible



	cm	↑ cm	€
17091	11 x 7,5	40	16,00

Lieferung ohne Leuchtkopf Nr. 17090
delivery without light head no. 17090



BRIDGE



Kühlbox „BRIDGE“

refrigerated buffet display
set de buffet refrigerado
présentoir buffet froid



Set bestehend aus: 1 Gestell aus Ahorn oder Wenge, 1 Behälter aus Kunststoff, 1 GN1/1 Tablett aus Melamin, 1 Kühlakku, 1 Rolltophaube (fix montiert)

set consists of: 1 base element maple or wenge, 1 plastic insert black, 1 GN1/1 tray melamine, 1 cooler, 1 cover (fixed)

set compuesto por: 1 soporte de madera arce o wengué, 1 cubeta de plástico, 1 bandeja de melamina GN 1/1, 1 acumulador de frío, 1 campana rolltop (fija)

set composé de: 1 support en bois érable ou wengé, 1 bac plastique, 1 plat en mélamine GN 1/1, 1 accumulateur de froid, 1 cloche rolltop (fixe)

	cm	↑ cm	Farbe / Colour	€
13990	63,5 x 42,5	31	Ahorn / maple	370,00
14990	63,5 x 42,5	31	Buche / beech	370,00

2 sizes
0,50 ltr. / 2,50 ltr.



14980



Kühlschale „BRIDGE“

cooling bowl
bol refrigerado
bol réfrigéré



4-teilig: 1 Gestell aus Ahorn oder Wenge, 1 Behälter aus Edelstahl, 1 Schale aus Melamin (Ø 14 cm o. 23 cm), 1 Kühlakku

4 pcs.: 1 base element maple or wenge, 1 bowl stainless steel, 1 bowl melamine (Ø 14 or 23 cm), 1 cooler

set de 4: 1 soporte de madera arce o wengué, 1 cuenco de acero inoxidable, 1 cuenco de melamina (Ø 14 cm o 23 cm), 1 acumulador de frío

set de 4: 1 support en bois érable ou wengé, 1 bol en acier inox, 1 bol en mélamine (Ø 14 cm ou 23 cm), 1 accumulateur de froid

	cm	↑ cm	ltr.	Farbe / Colour	€
14980	18,5 x 18,5	10	0,5		65,00
14981	27,5 x 27,5	14	2,5		124,00

**Besteckbehälter „BRIDGE“**

cutlery organizer
cajón para cubiertos
bac à couverts



2 teiliges Set: 1 Gestell, 1 Besteckbehälter (Nr. 11955), herausnehmbar

2 pcs.: 1 base element, 1 removable plastic container (item 11955)

set de 2: 1 soporte, 1 cajón para cubiertos (ref. 11955) extraíble

set de 2: 1 support, 1 bac à couverts (réf. 11955) amovible

	cm	↑ cm	Farbe / Colour		€
13995	57,5 x 37	12		Ahorn / maple	94,00
14995	57,7 x 37	12		Buche / beech	94,00

**Cerealienspender „BRIDGE“**

cereal dispenser
dispensador de cereales
distributeur de céréales



Behälter herausnehmbar, „Feierabend-Deckel“ für das aromadichte Lagern, Portionieren durch einfaches Drehen

removable canister, special lid to keep the cereals fresh, easy to use, rotate the button to get the muesli

contenedor extraíble, tapa especial para mantener los cereales frescos, fácil de usar, se gira el pomo para servir los cereales

réceptacle amovible, couvercle spécial pour conserver les céréales, usage facile en tournant le bouton

	cm	↑ cm	ltr.	Farbe / Colour		€
13987	21 x 20	55,5	4,5		Ahorn / maple	114,00
14987	21 x 20	55,5	4,5		Buche / beech	114,00

13987 4,5 ltr.

14987 4,5 ltr.



10836

Milchdispenser „BRIDGE“

milk dispenser
dispensador de leche
distributeur à lait



Edelstahl Dispenser mit 1 Kühlakku im Standfuß inklusive touchless adapter

stainless steel dispenser with 1 cooling element in stand including touchless adapter
dispensador de acero inoxidable con 1 acumulador de frío en la base y con adaptador sin contacto para grifo
distributeur en acier inox avec 1 accumulateur de froid dans le socle et avec adaptateur sans contact manuel

	cm	↑ cm	ltr.	Farbe / Colour		€
10836	31 x 20	39	3		Ahorn / maple	279,00
10838	39 x 22	45	5		Ahorn / maple	444,00



10837

Milchdispenser „BRIDGE“

milk dispenser
dispensador de leche
distributeur à lait



Edelstahl Dispenser mit 1 Kühlakku im Standfuß inklusive touchless adapter

stainless steel dispenser with 1 cooling element in stand including touchless adapter
dispensador de acero inoxidable con 1 acumulador de frío en la base y con adaptador sin contacto para grifo
distributeur en acier inox avec 1 accumulateur de froid dans le socle et avec adaptateur sans contact manuel

	cm	↑ cm	ltr.	Farbe / Colour		€
10837	31 x 20	39	3		Buche / beech	279,00
10839	39 x 22	45	5		Buche / beech	444,00



4 ltr.

10870

Saftdispenser „BRIDGE“

juice dispenser
dispensador de zumo
distributeur à jus



Kühlung durch 2 Kühlakkus von oben und unten

cooling with 2 cooling elements from the top and base
2 acumuladores de frío: 1 en la base y 1 en la tapa
2 accumulateurs de froid: 1 dans le couvercle et 1 dans le socle

	cm	↑ cm	ltr.	Farbe / Colour		€
10870	31,0 x 20	42	4		Ahorn / maple	239,00
10871	35,5 x 22	50	6		Ahorn / maple	279,00



inklusive 3 Magnetschilder: ORANGE, APPLE, GRAPEFRUIT
including 3 magnetic signs: ORANGE, APPLE, GRAPEFRUIT



6 ltr.

10873

Saftdispenser „BRIDGE“

juice dispenser
dispensador de zumo
distributeur à jus



Kühlung durch 2 Kühlakkus von oben und unten

cooling with 2 cooling elements from the top and base
2 acumuladores de frío: 1 en la base y 1 en la tapa
2 accumulateurs de froid: 1 dans le couvercle et 1 dans le socle

	cm	↑ cm	ltr.	Farbe / Colour		€
10872	31,0 x 20	42	4		Buche / beech	239,00
10873	35,5 x 22	50	6		Buche / beech	279,00



inklusive 3 Magnetschilder: ORANGE, APPLE, GRAPEFRUIT
including 3 magnetic signs: ORANGE, APPLE, GRAPEFRUIT



Buffetgestell „TRIANGLE“

buffet stand
expositor de buffet
présentoir buffet



Buche massiv, 3 Ebenen: 1.: 53 x 19 cm, 2.: 40 x 17,5 cm, 3.: 30 x 15 cm
 beech maple, 3 levels: 1.: 53 x 19 cm, 2.: 40 x 17,5 cm, 3.: 30 x 15 cm
 haya sólido, 3 niveles: 1.: 53 x 19 cm, 2.: 40 x 17,5 cm, 3.: 30 x 15 cm
 hêtre massif, 3 niveaux: 1.: 53 x 19 cm, 2.: 40 x 17,5 cm, 3.: 30 x 15 cm

	cm	↑ cm	Farbe / Colour	€
13966	53 x 21	50		145,00
14966	53 x 21	50		145,00



Buffet Box „SEWING BASKET“

buffet box
caja de buffet
boîte de buffet



aus geöltem Eichenholz, 3 Fächer: 33 x 27 cm, H: 7 cm, passend für GN 1/2
 made of oiled oak wood, 3 compartments: 33 x 27 cm, H: 7 cm, suitable for GN 1/2
 de madera de roble aceitada, 3 compartimentos: 33 x 27 cm, H: 7 cm, para GN 1/2
 en bois de chêne huilé, 3 compartiments: 33 x 27 cm, H: 7 cm, pour GN 1/2

	cm	↑ cm	Farbe / Colour	€
11711	36 x 29	28	natural oak	308,00
11712	36 x 29	28	dark oak	308,00

geschlossen | closed
37 x 29 cm, H: 28 cm

geöffnet | open
70,5 x 37 cm, H: 53,5 cm

FRAMES



Kühltablets SET 1 „FRAMES“

cooling plates
bandejas refrigeradas
plateaux réfrigérés



GN 1/1 Basiselement, GN 1/1 Edelfstahl Tablett 18/10, Kühlakku
GN 1/1 base element, GN 1/1 stainless steel platter 18/10, cooler
elemento básico GN 1/1, bandeja GN 1/1 de acero inoxidable 18/10, acumulador de frío
élément de base GN 1/1, plateau GN 1/1 en acier inox 18/10, accumulateur de froid

	cm	↑ cm	GN	Farbe / Colour	€
12940	53 x 32,5	8,5	1/1	white	246,00
14940	53 x 32,5	8,5	1/1	wenge wood	249,00



Kühltablets SET 2 „FRAMES“

cooling plates
bandejas refrigeradas
plateaux réfrigérés



GN 1/1 Basiselement, GN 1/1 Edelfstahl Tablett 18/10, Rolltophaube, Kühlakku
GN 1/1 base element, GN 1/1 stainless steel platter, rolltop cover, cooler
elemento básico GN 1/1, bandeja GN 1/1 de acero inoxidable 18/10, campana rolltop,
acumulador de frío
élément de base GN 1/1, plateau GN 1/1 en acier inox 18/10, cloche rolltop, accumulateur de froid

	cm	↑ cm	GN	Farbe / Colour	€
12941	53 x 32,5	27,5	1/1	white	310,00
14941	53 x 32,5	27,5	1/1	wenge wood	314,00



82355
GN 1/1

GN Tablett „FRAMES“

GN tray
GN bandeja
GN plateau



	cm	↑ cm	GN	€
82355	53,0 x 32,5	2	1/1	46,00
82356	32,5 x 26,5	2	1/2	26,00
82357	32,5 x 17,6	2	1/3	22,00



GN Edelstahl Tablett „FRAMES“

GN stainless steel platter
GN bandeja acero inoxidable
GN plateau acier inox



	cm	↑ cm	GN	€
11119	53,0 x 32,5	2	1/1	33,00



84046

GN Tablett „FRAMES“

GN tray
GN bandeja
GN plateau



	cm	↑ cm	GN	€
84046	53,0 x 32,5	2	1/1	33,00
84047	32,5 x 26,5	2	1/2	18,40
84048	32,5 x 17,6	2	1/3	12,60



GN Wanne „FRAMES“

GN tray
GN bandeja
GN plateau



	cm	↑ cm	GN	fits to	€
17922	53 x 32,5	8	1/1	12940, 14940	60,00

FRAMES

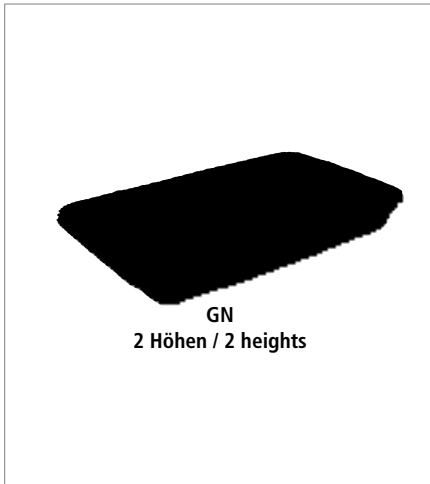

Korb „GN LINE“

GN basket

GN cesta

GN corbeille



stabile Ausführung mit Edelstahldraht im Rand zur Stabilisierung

very solid with stainless steel wire frame to stabilize the basket

muy resistente con alambre de acero inoxidable en el borde para la estabilización

très résistante avec fil d'acier inox dans le bord pour la stabilisation

	cm	↑ cm	GN	€
40291	53,0 x 32,5	6,5	1/1	26,00
40290	32,5 x 26,5	6,5	1/2	15,80
40293	53,0 x 32,5	10,0	1/1	31,40
40292	32,5 x 26,5	10,0	1/2	18,80



Buffetkorb „ECONOMIC“

basket

cesta

corbeille

Polyrattan, mit Haubenschiene (ohne Haube)

polyrattan, with frame to fix the cover (without cover)

polyrattan, con fijación para campana (sin campana)

polyrattan, avec fixation pour la cloche (sans cloche)



	cm	↑ cm	€
40294	56,5 x 36,0	10	33,00



Buffetkorb „ECONOMIC“

buffet basket

cesta de buffet

corbeille de buffet

Polyrattan, mit Haubenschiene (ohne Haube)

polyrattan, with frame to fix the cover (without cover)

polyrattan, con fijación para campana (sin campana)

polyrattan, avec fixation pour la cloche (sans cloche)



	Ø cm	↑ cm	€
40295	40	12,5	23,00



Rolltophaube

rolltop cover

campana abatible

cloche basculante



	Ø cm	↑ cm	€
18389	38	20	23,00



GN 1/1 Rolltophaube

GN 1/1 rolltop cover

GN 1/1 campana abatible

GN 1/1 cloche basculante

verchromter Zinkdruckguss-Griff

chrome plated metal handle

mango cromado de fundición a presión de zinc

poignée en zinc moulé sous pression chromé



	cm	↑ cm	GN	€
11018	53 x 32,5	17	1/1	64,00



vielseitig einsetzbar für alle GN 1/1 Artikel

11018

12940

14953

Gestell für GN 1/1 „FRAMES“

serving stand GN 1/1
soporte para GN 1/1
support pour GN 1/1

Buche massiv, Wenge
solid beech, colour wenge
haya maciza, color wengué
hêtre massif, couleur wengé



	cm	↑ cm	€
14953	57,5 x 27,5	22	90,00



84047
GN 1/2

passendes Kühltablett Set



14956
passende Besteck / Universal-Box GN 1/1

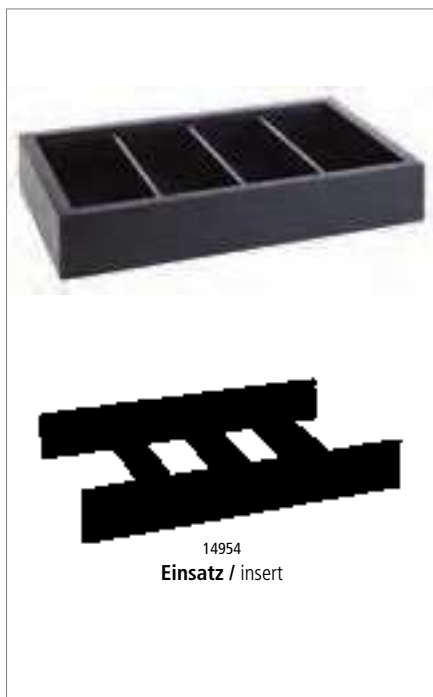

Einsatz / insert

Besteck- / Universal-Box, 2-teilig „FRAMES“

cutlery tray, 2 pcs.
cubertero o cajón multi-usos, set de 2
caisson à couverts ou multi-usages, set de 2

Buche massiv, Wenge, 4 Fächer, inklusive herausnehmbaren Einsatz
solid beech, colour wenge, 4 compartments, including removable insert
haya maciza, color wengué, 4 compartimentos, con separador extraíble
hêtre massif, couleur wengé, 4 compartiments, avec insert amovible



	cm	↑ cm	GN	€
14956	53 x 32,5	11	1/1	184,00

Einsatz für GN 1/1 „FRAMES“ / insert for GN1/1 / separador para GN1/1 / insert pour GN1/1

	cm	↑ cm	€
14954	48,5 x 28	8	44,00



Eisbox „FRAMES“

ice box
bandeja para hielo
caisse à glaçons

3-teilig: 1 Basiselement Wenge + 1 Polystyrolwanne + 1 Tropfgitter

3 pcs. set: 1 box wenge + 1 plastic deep tray + 1 drainer plate
set de 3: 1 cajón color wengué + 1 cubeta plástico + 1 rejilla
set de 3: 1 caisson couleur wengé + 1 bac plastique + 1 plaque perforée



	cm	↑ cm	GN	€
14970	53 x 32,5	12,5	1/1	189,00



Die stapelbaren Wendeböden lassen sich rutschfest stapeln und mit flachen GN Platten verbinden und einzeln nutzen. Individuell können Buffet-landschaften gebaut werden.

The stackable and non-slip reversible boxes can be connected to flat GN trays and can also be used individually. Different and individual buffet sceneries can be built up.

Las cajas girables y apilables son antideslizantes y se pueden conectar con bandejas planas GN o utilizar individualmente. Se pueden construir diferentes paisajes de buffet muy individuales.

Les boîtes de tournage empilables sont antiglissantes et peuvent être connectées avec des plateaux plats GN ou utilisées individuellement. Des paysages de buffet très personnalisés peuvent être construits.



GN 1/1 „SUPERBOX“



Akazienholz / acacia wood / madera de acacia / bois d'acacia

	cm	↑ cm	GN	Farbe / Colour	€
11620	55,5 x 35,0	10,5	1/1		46,00
11626	55,5 x 35,0	10,5	1/1		46,00
11721	55,5 x 35,0	20,0	1/1		70,00
11723	55,5 x 35,0	20,0	1/1		70,00



GN 2/4 „SUPERBOX“



Akazienholz / acacia wood / madera de acacia / bois d'acacia

	cm	↑ cm		Farbe / Colour	€
11623	55,5 x 18,5	10,5			38,00
11629	55,5 x 18,5	10,5			38,00



GN 1/2 „SUPERBOX“



Akazienholz / acacia wood / madera de acacia / bois d'acacia

	cm	↑ cm	GN	Farbe / Colour	€
11621	35,0 x 29,0	10,5	1/2		30,00
11627	35,0 x 29,0	10,5	1/2		30,00
11722	35,0 x 29,0	20,0	1/2		45,00
11724	35,0 x 29,0	20,0	1/2		45,00



GN 1/4 „SUPERBOX“

Akazienholz / acacia wood / mader de acacia / bois d'acacia



	cm	↑ cm	Farbe / Colour	€
11622	29 x 18,5	10,5		23,00
11628	29 x 18,5	10,5		23,00



Beschriftungsschilder, 2er Set

inscription labels, 2 pcs.
étiquettes d'inscription, set de 2
etiquetas de inscripción, set de 2



	cm	↑ cm	Farbe / Colour	€ / set
11719	8 x 1,5	5,5		8,80



Kreide-Marker, Stärke 2 mm, 2er Set

chalk marker, 2 pcs.
rotulador de tiza, set de 2
marqueur a la craie liquide, set de 2



	Ø cm	↑ cm	pcs.	Farbe / Colour	€ / set
71490	1	13	2		6,20



Buffetgestell

buffet stand
soporte para buffet
présentoir buffet

Metall, schwarz, passend für GN Boxen, mit Antirutschfüßchen

metal, black, suitable for GN boxes, with non-slip feet

metal, negro, para cajas GN, con pies antideslizantes

métal, noir, pour boîtes GN, avec pieds antidérapantsw



	cm	↑ cm	suitable for	Farbe / Colour	€
30329	29 x 32,5	48	GN 1/2 boxes, height 10,5 cm		42,00
30331	49 x 38,5	48	GN 1/1, GN 1/2 boxes		50,00



Präsentationsmöglichkeit
presentation example



GN Tablett „ZERO“

GN tray
GN bandeja
GN plateau



	cm	↑ cm	GN	Farbe / Colour	€
84185	53,0 x 32,5	1,5	1/1		41,40
84186	32,5 x 26,5	1,5	1/2		22,40
84188	26,5 x 16,2	1,5	1/4		12,60
84189	53,0 x 16,2	1,5	2/4		24,60



GN Naturschieferplatten

GN natural slate tray
GN bandeja de pizarra natural
GN plat ardoise naturelle



gebrochene Kanten
broken edges
bordes biselados
bords biseautés

	cm	✦ mm	GN	€
00990	53,0 x 32,5	6 - 9	1/1	15,80
00991	32,5 x 26,5	6 - 9	1/2	8,80
00993	26,5 x 16,2	6 - 9	1/4	5,00
00973	53,0 x 16,2	6 - 9	2/4	6,50



GN Einsatz „SUPERBOX“

GN insert
GN bandeja
GN bac supérieur



	cm	↑ cm	GN	fits to	€
11616	53,0 x 32,5	8,5	1/1	11620, 11626	32,00
11617	32,5 x 26,5	8,5	1/2	11621, 11627	26,40



3 tlg.
3 pcs.

11645

11075

00979

10782

Kühlakkus halten Ihre Speisen über lange Zeit kühl
coolers keep the food cool for a long time

Kühlbox „SLATE“
refrigerated buffet display
expositor buffet frío
plateau buffet froid



3-teilig, bestehend aus: 1 Basis aus schwarzem Polystyrol, 1 Naturschieferplatte, 1 Kühlakku (ohne Haube)

3 pcs., set consists of: 1 base made of black polystyrene, 1 natural slate tray, 1 cooler (without cover)

set de 3 compuesto por: 1 soporte de poliestireno negro, 1 bandeja de pizarra natural, 1 acumulador de frío (sin campana)

set de 3 composé de: 1 support en polystyrène noir, 1 plateau en ardoise naturelle, 1 accumulateur de froid (sans couvercle)

	cm	↑ cm	€
11645	58 x 38	6,5	80,00

Naturschieferplatte / natural slate tray / bandeja de pizarra natural / plateau ardoise naturelle

	cm	mm	€
00979	58 x 38	6 - 9	19,00

Kühlakku / cooler / acumulador de frío / accumulateur de froid

	cm	↑ cm	€
10782	41 x 21	2,5	16,00

GN Rolltophaube mit schwarzem Griff / GN rolltop cover with black handle / GN campana rolltop con mango negro / GN cloche rolltop avec poignée noire

	cm	↑ cm	GN	€
11075	53 x 32,5	19	1/1	62,00

4 tlg.
4 pcs.

11010

11503

11100

11505

11010

11505

10791

Kühlakkus halten Ihre Speisen über lange Zeit kühl
coolers keep the food cool for a long time

Kühlbox „TOP FRESH GN 1/1“

cooling plate
bandeja de frío
présentoir buffet réfrigéré



4-teilig: 1 Kühlbox + 1 Tablett GN 1/1 + 2 Kühlakkus, ohne Haube

4 pcs.: 1 box + 1 tray GN 1/1 + 2 coolers, without cover

set de 4: 1 caja + 1 bandeja GN 1/1 + 2 acumuladores de frío, sin campana

set de 4: 1 caisson + 1 plateau GN 1/1 + 2 accumulateurs de froid, sans cloche

	cm	↑ cm	Farbe / Colour	€
11503	56,5 x 35	6,5	White	104,00
11505	56,5 x 35	6,5	Black	104,00

GN Rolltophaube mit verchromtem Kreuzgriff / GN rolltop cover with chrome-plated cross handle / GN campana rolltop con asa en cruz cromada / GN cloche rolltop avec manche en croix chromée

	cm	↑ cm	GN	€
11010	53 x 32,5	19	1/1 mit verchromtem Kreuzgriff	64,00

Kühlakku / cooler / acumulador de frío / accumulateur de froid

	cm	↑ cm	€
10791	25 x 19	2,5	8,40

GN Edelstahl-Tablett „PROFI LINE“ / GN tray / GN bandeja / GN plateau

	cm	↑ cm	GN	€
11100	53 x 32,5	1,5	1/1	31,00

COOLING DISPLAYS

4 tlg.
4 pcs.



11546



11075

Buche, wasserfest lackiert
beech wood lacquered



10791

**Kühlakku halten Ihre Speisen
über lange Zeit kühl**
coolers keep the food
cool for a long time

Buffetvitrine „TOP FRESH GN 1/1“ refrigerated buffet display expositor buffet frío plateau buffet froid



4-teilig: 1 Box aus Buchenholz mit Kunststoffwanne + 1 Edelstahl-Tablett GN 1/1 + 2 Kühlakku, ohne Haube

4 pcs.: 1 beech wood box with plastic insert + 1 stainless steel tray GN 1/1 + 2 coolers, without cover

set de 4: 1 caja de madera de haya con bandeja de plástico + 1 bandeja de acero inoxidable GN 1/1 + 2 acumuladores de frío, sin campana

set de 4: 1 boîte en bois de hêtre avec bac en plastique + 1 plateau en acier inox GN 1/1 + 2 accumulateurs de froid, sans cloche

	cm	↑ cm	€
11546	60 x 41	5	189,00

GN Rolltophaube mit schwarzem Griff / GN rolltop cover with black handle / GN campana rolltop con mango negro / GN cloche rolltop avec poignée noir

	cm	↑ cm	GN	€
11075	53 x 32,5	19	1/1	62,00

GN Rolltophaube mit Chromgriff / GN rolltop cover with chrome handle / GN campana rolltop con asa cromada / GN cloche rolltop avec poignée chromée

	cm	↑ cm	GN	€
11010	53 x 32,5	19	1/1	64,00

Kühlakku / cooler / acumulador de frío / accumulateur de froid

	cm	↑ cm	€
10791	25 x 19	2,5	8,40

12 tlg.
12 pcs.



11547

Buche, wasserfest lackiert
beech wood lacquered



10791

**Kühlakku halten Ihre Speisen
über lange Zeit kühl**
coolers keep the food
cool for a long time

Buffetvitrine „DOPPELDECKER GN 1/1“ refrigerated buffet display expositor buffet frío plateau buffet froid



12-teilig: 2 Boxen aus Buchenholz mit Kunststoffwanne + 2 Edelstahl-Tablets GN 1/1 + 4 Kühlakku + 4 verchromte Stangen, ohne Hauben

12 pcs.: 2 beech wood boxes with plastic insert + 2 stainless steel trays GN 1/1 + 4 coolers + 4 chrome-plated bars, without covers

set de 12: 2 cajas de madera de haya con bandeja de plástico + 2 bandejas de acero inoxidable GN 1/1 + 4 acumuladores de frío + 4 barras cromadas, sin campanas

set de 12: 2 boîtes en bois de hêtre avec bac en plastique + 2 plateaux en acier inox GN 1/1 + 4 accumulateurs de froid + 4 barres chromées, sans cloches

	cm	↑ cm	€
11547	60 x 41	36	348,00

GN Rolltophaube mit schwarzem Griff / GN rolltop cover with black handle / GN campana rolltop con asa negra / GN cloche rolltop avec poignée noir

	cm	↑ cm	GN	€
11075	53 x 32,5	19	1/1	62,00

GN Rolltophaube mit Chromgriff / GN rolltop cover with chrome handle / GN campana rolltop con asa cromada / GN cloche rolltop avec poignée chromée

	cm	↑ cm	GN	€
11010	53 x 32,5	19	1/1	64,00

Kühlakku / cooler / acumulador de frío / accumulateur de froid

	cm	↑ cm	€
10791	25 x 19	2,5	8,40

4 tlg.
4 pcs.



11540



11010

Buche, wasserfest lackiert
beech wood lacquered



10791

Kühlakku halten Ihre Speisen über lange Zeit kühl
coolers keep the food cool for a long time

Buffetvitrine „TOP FRESH GN 1/1“

refrigerated buffet display
expositor buffet frío
plateau buffet froid



4-teilig: 1 Box aus Buchenholz mit Kunststoffwanne + 1 Edelstahl-Tablett GN 1/1 + 2 Kühlakkus, ohne Haube

4 pcs.: 1 beech wood box with plastic insert + 1 stainless steel tray GN 1/1 + 2 coolers, without cover

set de 4: 1 caja de madera de haya con bandeja de plástico + 1 bandeja de acero inoxidable GN 1/1 + 2 acumuladores de frío, sin campana

set de 4: 1 boîte en bois de hêtre avec bac en plastique + 1 plateau en acier inox GN 1/1 + 2 accumulateurs de froid, sans cloche

	cm	↑ cm	€
11540	60 x 41	5	189,00

GN Rolltophaube mit Chromgriff / GN rolltop cover with chrome handle / GN campana rolltop con asa cromada / GN cloche rolltop avec poignée chromée

	cm	↑ cm	GN	€
11010	53 x 32,5	19	1/1	64,00

Kühlakku / cooler / acumulador de frío / accumulateur de froid

	cm	↑ cm	€
10791	25 x 19	2,5	8,40

12 tlg.
12 pcs.



11541

Buche, wasserfest lackiert
beech wood lacquered



10791

Kühlakku halten Ihre Speisen über lange Zeit kühl
coolers keep the food cool for a long time

Buffetvitrine „DOPPELDECKER GN 1/1“

cooling buffet display
expositor buffet frío
vitrine buffet



12-teilig: 2 Boxen aus Buchenholz mit Kunststoffwanne + 2 Edelstahl-Tabletts GN 1/1 + 4 Kühlakkus + 4 verchromte Stangen, ohne Hauben

12 pcs.: 2 beech wood boxes with plastic insert + 2 stainless steel trays GN 1/1 + 4 coolers + 4 chrome-plated bars, without covers

set de 12: 2 cajas de madera de haya con bandeja de plástico + 2 bandejas de acero inoxidable GN 1/1 + 4 acumuladores de frío + 4 barras cromadas, sin campanas

set de 12: 2 boîtes en bois de hêtre avec bac en plastique + 2 plateaux en acier inox GN 1/1 + 4 accumulateurs de froid + 4 barres chromées, sans cloches

	cm	↑ cm	€
11541	60 x 41	36	348,00

GN Rolltophaube mit Chromgriff / GN rolltop cover with chrome handle / GN campana rolltop con asa cromada / GN cloche rolltop avec poignée chromée

	cm	↑ cm	GN	€
11010	53 x 32,5	19	1/1 Chrom-Griff	64,00

Kühlakku / cooler / acumulador de frío / accumulateur de froid

	cm	↑ cm	€
10791	25 x 19	2,5	8,40

COOLING DISPLAYS



09100



90902



11101

**Kühlakku halten Ihre Speisen
über lange Zeit kühl**
coolers keep the food
cool for a long time

Buffetvitrine showcase vitrina de buffet vitrine de buffet



5-teilig: 1 transparente Rolltophaube beidseitig aufklappbar + 1 Schale
+ 1 Edelstahl-Tablett 39 x 28 cm + 2 Kühllakku

5 pcs.: 1 transparent rolltop cover + 1 tray + 1 stainless tray 39 x 28 cm + 2 coolers

set de 5: 1 tapa abatible, por ambos lados, transparente + 1 bandeja + 1 bandeja de acero inoxidable 39 x 28 cm + 2 acumuladores de frío

set de 5: 1 cloche transparente ouverture 2 côtés + 1 caisson + 1 plateau en acier inox 39 x 28 cm + 2 accumulateurs de froid

	cm	↑ cm	Farbe / Colour	€
09100	44 x 32	20,5	White	53,00
09104	44 x 32	20,5	Black	53,00

Kühlakku / cooler / acumulador de frío / accumulateur de froid

	cm	↑ cm	pcs.	€ / set
11101	16 x 7,5	2	4	7,00

Edelstahl-Tablett / stainless steel tray / bandeja de acero inoxidable / plateau inox

	cm	↑ cm	€
90902	39,5 x 28,5	1	9,60



09200



09204



11101

**Kühlakku halten Ihre Speisen
über lange Zeit kühl**
coolers keep the food
cool for a long time

Buffetvitrine „DOPPELDECKER“ showcase vitrina de buffet, 2 alturas vitrine de buffet double



2 transparente Rolltophauben beidseitig aufklappbar + 2 Schalen + 2 Edelstahl-Tabletts 39 x 28 cm + 4 Kühllakku, platzsparend lagerbar

2 transparent rolltop cover + 2 trays + 2 tray 39 x 28 cm + 4 coolers, space saving

2 campanas abatibles por ambos lados transparentes + 2 bandejas + 2 bandejas de acero inoxidable 39 x 28 cm + 4 acumuladores de frío, almacenamiento en poco espacio

2 cloches transparentes abattantes 2 côtés + 2 caissons + 2 plateaux en acier inox 39 x 28 cm + 4 accumulateurs de froid, peut encombrant à stocker

	cm	↑ cm	Farbe / Colour	€
09200	44 x 32	44	White	104,00
09204	44 x 32	44	Black	104,00

Kühlakku / cooler / acumulador de frío / accumulateur de froid

	cm	↑ cm	pcs.	€ / set
11101	16 x 7,5	2	4	7,00

Edelstahl-Tablett / stainless steel tray / bandeja de acero inoxidable / plateau inox

	cm	↑ cm	€
90902	39,5 x 28,5	1	9,60

6 tlg.
6 pcs.



09091



09090



11101

**Kühlakkus halten Ihre Speisen
über lange Zeit kühl**
coolers keep the food
cool for a long time

Thermo Tablett-Set, 6-teilig

thermo tray, 6 pcs.

bandeja térmica, set de 6

plateau thermique, set de 6



- 6-teilig:
- 1 Schale
 - 1 Edelstahltablett
 - 2 Kühlakkus
 - 1 transparente Frischhaltehaube
 - 1 Transport- und Tragegurt aus Silikon

- 6 pcs.:
- 1 plastic tray
 - 1 stainless steel tray
 - 2 coolers
 - 1 transparent cover
 - 1 silicone transport and carrying strap

- set de 6:
- 1 bandeja de plástico
 - 1 bandeja de acero inoxidable
 - 2 acumuladores de frío
 - 1 campana transparente
 - 1 correa de silicona para cierre y transporte

- set de 6:
- 1 plateau plastique
 - 1 plateau en acier inox
 - 2 accumulateurs de froid
 - 1 cloche transparente
 - 1 sangle en silicone pour fermeture et transport

	cm	↑ cm	Farbe / Colour	€
09091	43 x 29	14		27,00
09090	43 x 29	14		27,00



inklusive 2 Kühlakkus
including 2 coolers

6 tlg.
6 pcs.



09094

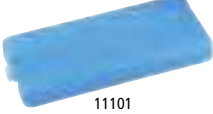

09093

11101

**Kühlakkus halten Ihre Speisen
über lange Zeit kühl**
coolers keep the food
cool for a long time

Thermo Tablett-Set, 6-teilig

thermo tray, 6 pcs.

bandeja térmica, set de 6

plateau thermique, set de 6



- 6-teilig:
- 1 Schale
 - 1 Edelstahltablett
 - 2 Kühlakkus
 - 1 transparente Frischhaltehaube
 - 1 Transport- und Tragegurt aus Silikon

- 6 pcs.:
- 1 plastic tray
 - 1 stainless steel tray
 - 2 coolers
 - 1 transparent cover
 - 1 silicone transport and carrying strap

- set de 6:
- 1 bandeja de plástico
 - 1 bandeja de acero inoxidable
 - 2 acumuladores de frío
 - 1 campana transparente
 - 1 correa de silicona para cierre y transporte

- set de 6:
- 1 plateau plastique
 - 1 plateau en acier inox
 - 2 accumulateurs de froid
 - 1 cloche transparente
 - 1 sangle en silicone pour fermeture et transport

	cm	↑ cm	Farbe / Colour	€
09094	35	15		27,00
09093	35	15		27,00



inklusive 2 Kühlakkus
including 2 coolers

COOLING DISPLAYS

3 tlg.
3 pcs.



11542

Buche, wasserfest lackiert
beech wood lacquered



18388

11542



10791

**Kühlakkus halten Ihre Speisen
über lange Zeit kühl**
coolers keep the food
cool for a long time

Kühltablett „TOP FRESH RUND“

refrigerated buffet display
expositor buffet frío redondo
présentoir buffet



3-teilig: 1 Box aus Buchenholz mit Kunststoffwanne + 1 Edelstahl-Tablett Ø 38 cm
+ 1 Kühlakku, ohne Haube

3 pcs.: 1 beech wood box with plastic insert + 1 stainless tray Ø 38 cm + 1 cooler, without cover

set de 3: 1 caja de madera de haya con bandeja de plástico + 1 bandeja de acero inoxidable Ø 38 cm + 1 acumulador de frío, sin campana

set de 3: 1 boîte en bois de hêtre avec bac en plastique + 1 plateau en acier inox Ø 38 cm + 1 accumulateur de froid, sans cloche

	Ø cm	↑ cm	€
11542	48	6	189,00

Rolltophaube mit verchromtem Kugelgriff / rolltop cover with chrome-plated ball handle / campana abatible con asa de bola cromada / cloche basculante avec poignée boule chromée

	Ø cm	↑ cm	€
18388	38	20	24,00

Rolltophaube mit vergoldetem Kugelgriff / rolltop cover with gold-plated ball handle / campana abatible con asa de bola dorada / cloche basculante avec poignée boule plaquée or

	Ø cm	↑ cm	€
18387	38	20	24,00

Kühlakku / cooler / acumulador de frío / accumulateur de froid

	cm	↑ cm	€
10791	25 x 19	2,5	8,40

11 tlg.
11 pcs.



11543

Buche, wasserfest lackiert
beech wood lacquered



10791

**Kühlakkus halten Ihre Speisen
über lange Zeit kühl**
coolers keep the food
cool for a long time

Buffetvitrine „DOPPELDECKER“

double refrigerated buffet display
expositor de buffet redondo doble
présentoir buffet froid, double



11-teilig: 2 Boxen aus Buchenholz mit Kunststoffwanne + 2 Edelstahl-Tablets Ø 38 cm
+ 2 Kühlakkus + 2 Kunststoffschalen + 3 verchromte Stangen, ohne Hauben

11 pcs.: 2 beech wood boxes with plastic tray + 2 stainless steel trays Ø 38 cm, 2 coolers + 3 chrome-plated bars, without covers

set de 11: 2 cajas de madera de haya con bandeja de plástico + 2 bandejas de acero inoxidable Ø 38 cm + 2 acumuladores de frío + 2 bandejas de plástico + 3 barras cromadas, sin campanas

set de 11: 2 boîtes en bois de hêtre avec bac en plastique + 2 plateaux en inox Ø 38 cm + 2 accumulateurs de froid + 2 plateaux en plastique + 3 barres chromées, sans cloches

	Ø cm	↑ cm	€
11543	48	38	312,00

Rolltophaube mit verchromtem Kugelgriff / rolltop cover with chrome-plated ball handle / campana abatible con asa de bola cromada / cloche basculante avec poignée boule chromée

	Ø cm	↑ cm	€
18388	38	20	24,00

Rolltophaube mit vergoldetem Kugelgriff / rolltop cover with gold-plated ball handle / campana abatible con asa de bola dorada / cloche basculante avec poignée boule plaquée or

	Ø cm	↑ cm	€
18387	38	20	24,00

Kühlakku / cooler / acumulador de frío / accumulateur de froid

	cm	↑ cm	€
10791	25 x 19	2,5	8,40

18388

09082

Kühlakkus halten Ihre Speisen über lange Zeit kühl
coolers keep the food cool for a long time

Thermo-Set
thermo set
bandeja isotérmica
set thermo



5-teilig: 1 Tablett tief + 1 Tablett flach + 2 Kühlakkus + 1 Rolltophaube

5 pcs.: 1 deep tray + 1 tray + 2 cooler + 1 rolltop cover

set de 5: 1 bandeja honda + 1 bandeja plana + 2 acumuladores frío + 1 campana rolltop

set de 5: 1 plateau creux + 1 plateau plat + 2 accumulateurs de froid + 1 cloche rolltop

	Ø cm	↑ cm	€
09082	38	24	52,00

Rolltophaube mit verchromtem Kugelgriff / rolltop cover with chrome-plated ball handle / campana abatible con asa de bola cromada / cloche basculante avec poignée boule chromée

	Ø cm	↑ cm	€
18388	38	20	24,00

Kühlakku / cooler / acumulador de frío / accumulateur de froid

	cm	↑ cm	pcs.	€/ set
11101	16 x 7,5	2	4	7,00

4 tlg.
4 pcs.

11845 2,5 ltr.

11875

10777

Kühlakkus halten Ihre Speisen über lange Zeit kühl
coolers keep the food cool for a long time

Kühlschale Maxi „TOP FRESH“

cool bowl maxi
cuenco refrigerado maxi
bol réfrigéré maxi



4-teilig: 1 Gefäß hochglanzpoliert + 1 Kühlakku + 1 Glasschale + 1 klappbarer Deckel mit Beschriftungsschild

4 pcs.: 1 stainless steel bowl mirror polished + 1 cooler + 1 glass bowl + 1 hinged cover with label

set de 4: 1 recipiente de acero inoxidable pulido brillante + 1 acumulador de frío + 1 cuenco de vidrio + 1 tapa abatible con etiqueta

set de 4: 1 récipient en acier inox poli brillant + 1 accumulateur de froid + 1 bol en verre + 1 couvercle à charnière avec étiquette

	Ø cm	↑ cm	ltr.	€
11845	23	14	2,5	84,00

Ersatzschale / spare bowl / cuenco de recambio / bol de rechange

	Ø cm	↑ cm	ltr.	VE / unit	€/ pc.
11875	23,0	10,5	2,50	6	7,60

Schutzdeckel mit Löffelaussparung / cover / tapa / couvercle

	Ø cm	€
11878	23,5	12,60

Kühlakku / cooler / acumulador de frío / accumulateur de froid

	Ø cm	↑ cm	€
10777	15	2,5	5,40

83702

83703

Schale „CASUAL MAXI“

bowl
cuenco
bol



	Ø cm	↑ cm	ltr.	Farbe / Colour	€
83702	23	10,5	2,50	White	11,80
83703	23	10,5	2,50	Black	11,80

COOLING DISPLAYS



4 tlg.
4 pcs.

11812 **0,6 ltr.**



11813 **1 ltr.**



10661

Kühlakkus halten Ihre Speisen über lange Zeit kühl
coolers keep the food cool for a long time

Kühlschale Mini Holz „TOP FRESH“

cool bowl mini holz
bol refrigerado mini madera
bol réfrigéré mini bois



4-teilig: 1 Fuß Buchenholz versiegelt + 1 Schale + 1 Kühlakku + 1 klappbarer Deckel mit Beschriftungsschild

4 pcs.: 1 foot beech wood + 1 bowl + 1 cooler + 1 hinged cover with label
set de 4: 1 base de madera de haya + 1 cuenco + 1 acumulador de frío + 1 tapa abatible con etiqueta
set de 4: 1 pied en hêtre + 1 bac + 1 accumulateur de froid + 1 couvercle à charnière avec étiquette

	Ø cm	↑ cm	ltr.	€
11812	14	9,0	0,6	44,00
11813	14	11,5	1,0	48,00

Ersatzschale / spare bowl / cuenco de recambio / bol de rechange

	Ø cm	↑ cm	€
11811	14	6,5	18,20
11816	14	9,0	25,40

Schutzdeckel mit Löffelaussparung / cover / tapa / couvercle

	Ø cm	€
11868	14,5	12,00

Kühlakku / cooler / acumulador de frío / accumulateur de froid

	Ø cm	↑ cm	€
10661	10,5	2	3,40



4 tlg.
4 pcs.

11817 **2,5 ltr.**



11818 **4 ltr.**



10777

Kühlakkus halten Ihre Speisen über lange Zeit kühl
coolers keep the food cool for a long time

Kühlschale Maxi Holz „TOP FRESH“

cool bowl maxi holz
bol refrigerado maxi madera
bol réfrigéré maxi bois



4-teilig: 1 Fuß Buchenholz versiegelt + 1 Schale + 1 Kühlakku + 1 klappbarer Deckel mit Beschriftungsschild

4 pcs.: 1 foot beech wood + 1 bowl + 1 cooler + 1 hinged cover with label
set de 4: 1 base de madera de haya + 1 cuenco + 1 acumulador de frío + 1 tapa abatible con etiqueta
set de 4: 1 pied en hêtre + 1 bac + 1 accumulateur de froid + 1 couvercle à charnière avec étiquette

	Ø cm	↑ cm	ltr.	€
11817	22	14	2,5	104,00
11818	22	18	4,0	112,00

Ersatzschale / spare bowl / cuenco de recambio / bol de rechange

	Ø cm	↑ cm	€
11846	22	8	41,00
11848	22	12	54,00

Schutzdeckel mit Löffelaussparung / cover / tapa / couvercle

	Ø cm	€
11878	23,5	12,60

Kühlakku / cooler / acumulador de frío / accumulateur de froid

	Ø cm	↑ cm	€
10777	15	2,5	5,40



4 tlg.
4 pcs.

11812 **0,6 ltr.**



11815 **1 ltr.**



10661

Kühlakku halten Ihre Speisen über lange Zeit kühl
coolers keep the food cool for a long time

Kühlschale Mini „TOP FRESH“

cool bowl mini
bol refrigerado mini
bol réfrigéré mini



4-teilig: 1 Edelstahlgefäß matt + 1 Kühlakku + 1 Schale + 1 klappbarer Deckel mit Beschriftungsschild

4 pcs.: 1 stainless steel bowl matt + 1 bowl + 1 cooler + 1 hinged cover with label
set de 4: 1 recipiente de acero inoxidable mate + 1 cuenco + 1 acumulador de frío + 1 tapa abatible con etiqueta

set de 4: 1 récipient en acier inox mat + 1 bac + 1 accumulateur de froid + 1 couvercle à charnière avec étiquette

	Ø cm	↑ cm	ltr.	€
11810	14	9,0	0,6	48,00
11815	14	11,5	1,0	50,00

Ersatzschale / spare bowl / cuenco de recambio / bol de rechange

	Ø cm	↑ cm	€
11811	14	6,5	18,20
11816	14	9,0	25,40

Schutzdeckel mit Löffelaussparung / cover / tapa / couvercle

	Ø cm	€
11868	14,5	12,00

Kühlakku / cooler / acumulador de frío / accumulateur de froid

	Ø cm	↑ cm	€
10661	10,5	2	3,40



4 tlg.
4 pcs.

11847 **2,5 ltr.**



11849 **4 ltr.**



10777

Kühlakku halten Ihre Speisen über lange Zeit kühl
coolers keep the food cool for a long time

Kühlschale Maxi „TOP FRESH“

cool bowl maxi
bol refrigerado maxi
bol réfrigéré maxi



4-teilig: 1 Edelstahlgefäß hochglanzpoliert + 1 Kühlakku + 1 Schale + 1 klappbarer Deckel mit Beschriftungsschild

4 pcs.: 1 stainless steel bowl mirror polished + 1 bowl + 1 cooler + 1 hinged cover with label
set de 4: 1 recipiente de acero inoxidable pulido brillante + 1 cuenco + 1 acumulador de frío + 1 tapa abatible con etiqueta

set de 4: 1 récipient en acier inox poli brillant + 1 bac + 1 accumulateur de froid + 1 couvercle à charnière avec étiquette

	Ø cm	↑ cm	ltr.	€
11847	22	14	2,5	108,00
11849	22	18	4,0	112,00

Ersatzschale / spare bowl / cuenco de recambio / bol de rechange

	Ø cm	↑ cm	€
11846	22	8	41,00
11848	22	12	54,00

Schutzdeckel mit Löffelaussparung / cover / tapa / couvercle

	Ø cm	€
11878	23,5	12,60

Kühlakku / cooler / acumulador de frío / accumulateur de froid

	Ø cm	↑ cm	€
10777	15	2,5	5,40

BUFFET GUARD

3 Höhen einstellbar
3 heights adjustable

Servierbeispiel
presentation example



schwenkbar
swivelling



Hygieneschutz „BUFFET GUARD“

sneeze guard
protector anti aliento
pare-haleine

- transparente, höhenverstellbare Acrylplatte 80 x 53 cm
- Neigungswinkel stufenlos einstellbar
- transparent, height-adjustable acrylic plate 80 x 53 cm
- tilt angle continuously adjustable
- placa acrílica transparente y de altura ajustable 80 x 53 cm
- el ángulo de inclinación es infinitamente variable
- plaque en acrylique transparente 80 x 53 cm et réglable en hauteur
- angle d'inclinaison variable à l'infini



	cm	↑ cm	✂ mm	Fuß / base	€
98120	93 x 53	50,5	5	Metall schwarz / metal black	159,00



Antirutschfüßchen
non-slip feet

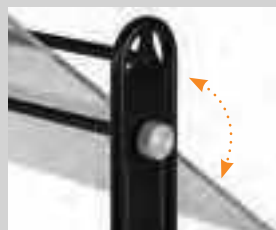

Der Neigungswinkel der Acrylplatte ist flexibel einstellbar
the angle of inclination of the acrylic plate is flexibly adjustable

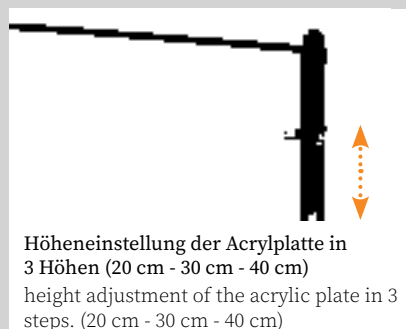

Höheneinstellung der Acrylplatte in 3 Höhen (20 cm - 30 cm - 40 cm)
height adjustment of the acrylic plate in 3 steps. (20 cm - 30 cm - 40 cm)



Anwendungsbeispiel
application example



Lieferung erfolgt demontiert
delivery takes place disassembled



Hygieneschutz
hygienic cover
campana higiénica antialiento
pare-haleine



- transparente Acrylabdeckung 75 x 42,5 cm
- Gestell aus Metall, verchromt
- transparent acrylic cover 75 x 42.5 cm
- frame made of metal, chrome-plated
- cubierta de acrílico transparente 75 x 42,5 cm
- marco de metal cromado
- couvercle acrylique transparent 75 x 42,5 cm
- structure en métal chromé

	cm	↑ cm	€
11556	82 x 42	45	220,00



Brötchenspender
roll dispenser
dispensador de panecillos
distributeur de petits pains



- hygienisch und einfach zu reinigen, mit Krümelschale
hygienic and easy to clean, with crumb tray
higiénico y fácil de limpiar, con bandeja para migas
hygiénique et facile à laver, avec plat ramasse-miettes

	cm	↑ cm		€
11572	32,5 x 27,5	42	für ca. 45-50 Brötchen / for approx. 45-50 rolls para 45-50 panecillos / pour 45-50 petits pains	199,00
11573	32,5 x 27,5	56	für ca. 65-70 Brötchen / for approx. 65-70 rolls para 65-70 panecillos / pour 65-70 petits pains	229,00



Haubenthalerung „FLEXIBLE“
cover holder
soporte de la campana
support de la cloche



- Bei dieser Haubenthalerung wird die Haube am Griff in die Vorrichtung gesteckt.
Für APS-Hauben geeignet!
With this cover holder, the cover is inserted into the device by the handle.
Suitable for APS covers!
Con este soporte de campana, la campana se cuelga simplemente por el asa.
¡Para campanas de APS!
Avec ce support, la cloche s'accroche simplement par la poignée.
Pour cloches APS!

	cm	↑ cm	€
33288	35,5 x 30	39	120,00

↗ Neigungswinkel stufenlos einstellbar
↘ inclination angle continuously adjustable

für 3 versch. Haubengrößen
for 3 different cover sizes
06519 Ø 21 cm
06520 Ø 30 cm
06521 Ø 36 cm



Präsentationsmöglichkeit
presentation example

DRAWER SET



50807
2 x Korb, schwarz

00910
3-teiliges Set
3 pcs. set



3 tlg.
3 pcs.

00910

00912

Schubladen Set, 3-teilig

drawer set, 3 pcs.
cajonera, set de 3
set tiroir, set de 3

3-teiliges Set:

- 1 Ständer aus Metall schwarz
- 1 Schublade mit Griff schwarz
- 1 Schneidebrett aus geöltem Walnussholz

3 pcs. set:

- 1 stand made of metal black
- 1 drawer with handle black
- 1 oiled walnut wood cutting board

set de 3:

- 1 soporte de metal negro
- 1 cajón con asa negra
- 1 tabla de cortar de madera de nogal engrasada

set de 3:

- 1 support métallique noir
- 1 tiroir avec poignée noire
- 1 planche à découper en bois de noyer huilé

HOLZ WOOD ACRYL ACRYLIC METALL

	cm	↑ cm	€
00910	35,4 x 32,5	20	174,00



15506

00912



00911

Präsentationsmöglichkeit
presentation example

Einzelteile / parts / piezas / pièces

	cm	↑ cm		€
00911	35,4 x 32,5	3,5	Schneidebrett / cutting board	77,00
00912	34,0 x 32,0	17,5	Schublade, Griff schwarz / drawer, handle black	82,00
00914	34,0 x 32,0	17,5	Schublade, Griff chrom / drawer, handle chrome	82,00
15506	35,4 x 32,5	17,6	GN Buffetständer schwarz/ GN buffet stand black	22,80

SNACKPRESENTER

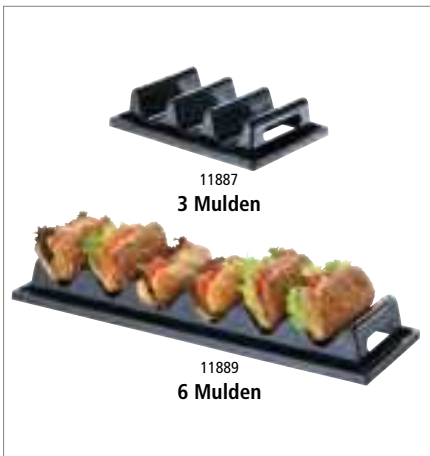

Snackpresenter

snackpresenter
dispensador de bocadillos
présentoir à sandwiches
mit Safrille und Griffmulde, passend für Vitrine 11888



with recessed grip, suitable for showcase 11888
asa moldeada, apto para la vitrina 11888
anse moulée, apte pour vitrine 11888

	cm	↑ cm		€
11887	29 x 19	6,5	3 Mulden / 3 compartiments 3 compartimentos / 3 compartiments	22,00
11889	60 x 19	7,5	6 Mulden / 6 compartiments 6 compartimentos / 6 compartiments	25,00



Snackpresenter

snackpresenter
dispensador de bocadillos
présentoir à sandwiches
hochglanzpoliert, mit Griffmulde, für 7 Baguettes



mirror polished, with recessed grip, for 7 baguettes
pulido brillante, con asa empotrada, ideal para 7 bocadillos
poli brillant, avec poignée encastrée, parfait pour 7 sandwiches

	cm	↑ cm		€
11891	47,5 x 10,5	6		32,00



Snackpresenter

snackpresenter
dispensador de bocadillos
présentoir à sandwiches



	cm	↑ cm		€
11969	56 x 8	5,5		14,00



Vitrine / Thekenaufsatz

showcase
vitrina de mostrador
vitrine de comptoir
rutschfest, aus einem Teil gefertigt



non-slip, monoblock produced
antideslizante, fabricado en 1 pieza
antidérapante, fabriquée en une seule pièce

	cm	↑ cm		€
11888	63,5 x 25	25		89,00

FROSTFIRE



FROSTFIRE Schalen und Tablett aus gegossenem Aluminium leiten die Wärme und Kälte nicht nur gut, sondern können diese auch lange speichern – ideal für den Einsatz in Kühlvitrinen, -regalen, auf Kühlischen und unter Wärmelampen. FROSTFIRE Schalen und Tablett halten servierbereite Speisen zuverlässig warm oder kalt.

FROSTFIRE bowls and trays made of cast aluminium not only conduct heat and cold well, but can also store it for a long time - ideal for use in refrigerated display cabinets, shelves, on refrigerated tables and under heat lamps. FROSTFIRE bowls and trays reliably keep ready-to-serve food warm or cold.

Los cuencos y las bandejas FROSTFIRE de aluminio fundido no sólo conducen bien el calor y el frío, sino que también pueden conservarlo durante mucho tiempo: ideales para su uso en vitrinas refrigeradas, estanterías, mesas refrigeradas y bajo lámparas de calor. Los cuencos y las bandejas FROSTFIRE mantienen de forma fiable los alimentos listos para servir calientes o fríos.

Les bols et plateaux FROSTFIRE en aluminium moulé conduisent non seulement bien la chaleur et le froid, mais peuvent aussi les conserver longtemps - idéal pour une utilisation dans des vitrines et étagères réfrigérées, sur des tables réfrigérées et sous des lampes chauffantes. Les bols et plateaux FROSTFIRE maintiennent les aliments prêts à être servis au chaud ou au froid de manière fiable.

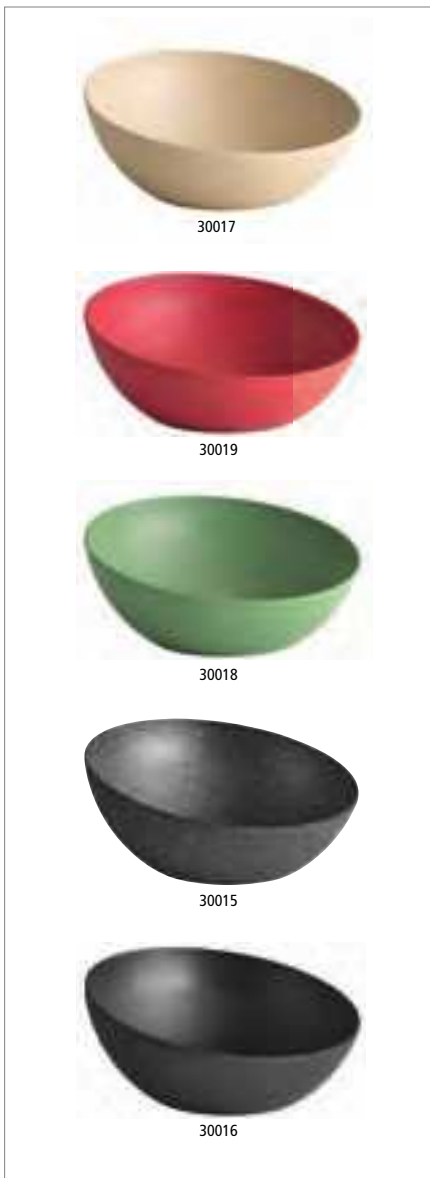

Schale „FROSTFIRE“

bowl
cuenco
bol



Antihafbeschichtung / non stick coating / antiadherente / revêtement anti-adhésif

	Ø cm	↑ cm	ltr.	Farbe / Colour	€
30017	26,5	7 / 12	1,9	beige / sand	42,00
30019	26,5	7 / 12	1,9	red	42,00
30018	26,5	7 / 12	1,9	green	42,00
30015	26,5	7 / 12	1,9	black / silver	42,00
30016	26,5	7 / 12	1,9	black	42,00

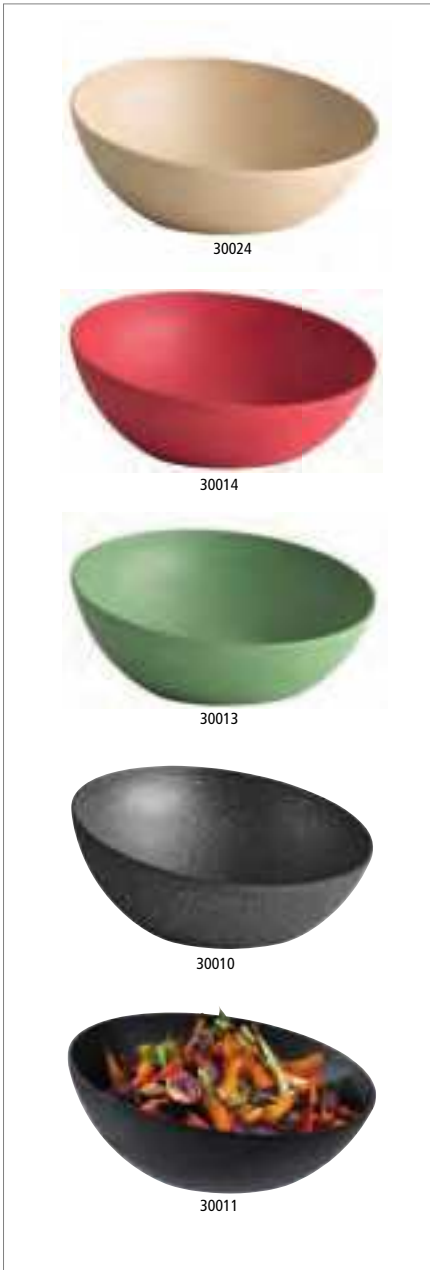

Schale „FROSTFIRE“

bowl
cuenco
bol



Antihafbeschichtung / non stick coating / antiadherente / revêtement anti-adhésif

	Ø cm	↑ cm	ltr.	Farbe / Colour	€
30024	32,5	8 / 14	3	beige / sand	48,00
30014	32,5	8 / 14	3	red	48,00
30013	32,5	8 / 14	3	green	48,00
30010	32,5	8 / 14	3	black / silver	48,00
30011	32,5	8 / 14	3	black	48,00



Präsentationsmöglichkeit
presentation example



Wärmelampe mit 2 Infrarotlampen

thermal bridge
puente térmico
pont thermique



höhenverstellbar 58 - 77,5 cm, inklusive 2 Lampen, Kabellänge: 1,5 Meter

height ajustable from 58 to 77,5 cm, including 2 infrared lamps, cable length: 1,5 metres
regulable en altura de 58 a 77,5 cm, con 2 lámparas de infrarrojos, longitud del cable: 1,5 metros
réglable en hauteur de 58 à 77,5 cm, avec 2 lampes infrarouges, longueur du câble: 1,5 mètre

	cm	↑ cm	V	W	Farbe / Colour	€
12265	50 x 35	58 - 77,5	230	2 x 250		145,00

Ersatzbirne für Wärmelampe

infrared lamp / bulb
lámpara infrarrojos / bombilla
lampe infrarouge / ampoule

Fassung E27, Lichtfarbe: warmweiß

socket: E27, light colour: warm white

casquillo: E27, color de la luz: blanco cálido

douille: E27, couleur de lumière: blanc chau

	W	fits to	€
12266	250	12265	10,00

FROSTFIRE



GN Tablett „FROSTFIRE“

GN tray
GN bandeja
GN plateau



Antihafbeschichtung / non stick coating / antiadherente / revêtement anti-adhésif

	cm	↑ cm	GN	Farbe / Colour	€
30500	53,0 x 32,5	3	1/1	black / silver	54,00
30501	32,5 x 26,5	3	1/2	black / silver	38,00
30505 <small>NEW</small>	32,5 x 17,6	3	1/3	black / silver	30,00
30506 <small>NEW</small>	26,5 x 16,2	3	1/4	black / silver	26,00
30502	53,0 x 16,2	3	2/4	black / silver	40,00



stabiler hoher Rand
stable high rim

	GN 1/2	GN 1/3		GN 1/4
GN 1/1		GN 1/3	GN 2/4	
	GN 1/2	GN 1/3		GN 1/4



GN Schale „FROSTFIRE“

GN bowl
GN cuenco
GN bol



Antihafbeschichtung / non stick coating / antiadherente / revêtement anti-adhésif

	cm	↑ cm	ltr.	GN	Farbe / Colour	€
30508	26,5 x 16,2	7,5	2,0	1/4	black / silver	36,00
30507	32,5 x 26,5	7,5	4,5	1/2	black / silver	46,00
30509	53,0 x 16,2	7,5	4,25	2/4	black / silver	49,00



Schale „FROSTFIRE“

bowl
cuenco
bol



Antihafbeschichtung / non stick coating / antiadherente / revêtement anti-adhésif

	cm	↑ cm	ltr.	Farbe / Colour	€
30503	19 x 19	9	1,5	black / silver	28,00
30504	25 x 25	12	3,8	black / silver	43,00



Schale „FROSTFIRE“

bowl
cuenco
bol



Antihafbeschichtung / non stick coating / antiadherente / revêtement anti-adhésif

	Ø cm	↑ cm	ltr.	Farbe / Colour	€
30510	45	10	5,6	black / silver	84,00



FROSTFIRE



Dressingtopf / Flaschenkühler „FROSTFIRE“

dressing pot / bottle cooler
 salsera / enfriador de botella
 pot à sauce / rafraîchisseur



Antihafbeschichtung / non stick coating / antiadherente / revêtement anti-adhésif

	Ø cm	↑ cm	ltr.	Farbe / Colour	€
36140	11,5 / 11	15	1,4	black / silver	17,60



auch als Flaschenkühler verwendbar
 also usable as a bottle cooler



Wärmelampe mit 2 Infrarotlampen

thermal bridge
 puente térmico
 pont thermique



höhenverstellbar 58 - 77,5 cm, inklusive 2 Lampen, Kabellänge: 1,5 Meter

height ajustable from 58 to 77,5 cm, including 2 infrared lamps, cable length: 1,5 metres

regulable en altura de 58 a 77,5 cm, con 2 lámparas de infrarrojos, longitud del cable: 1,5 metros

réglable en hauteur de 58 à 77,5 cm, avec 2 lampes infrarouges, longueur du câble: 1,5 mètre

	cm	↑ cm	V	W	Farbe / Colour	€
12265	50 x 35	58 - 77,5	230	2 x 250	black	145,00

Ersatzbirne für Wärmelampe

infrared lamp / bulb
 lámpara infrarrojos / bombilla
 lampe infrarouge / ampoule

Fassung E27, Lichtfarbe: warmweiß

socket: E27, light colour: warm white

casquillo: E27, color de la luz: blanco cálido

douille: E27, couleur de lumière: blanc chaud

	W	fits to	€
12266	250	12265	10,00



SPHERE

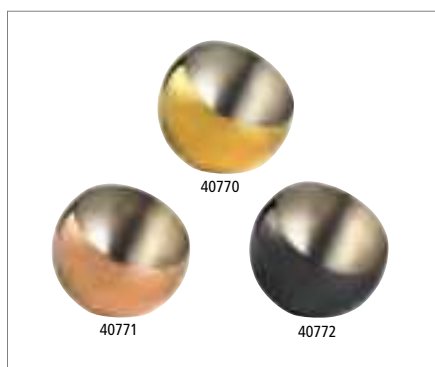

Schale, 3er Set „SPHERE“

bowl, 3 pcs.
cuenco, set de 3
bol, set of 3

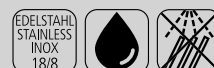

innen: mattiert / inside: matt / interior: mate / intérieur: mat

	Ø cm	↑ cm	ltr.	Farbe / Colour	pcs.	€ / set
40770	8	7	0,1	gold	3	29,00
40771	8	7	0,1	copper	3	29,00
40772	8	7	0,1	gunmetal	3	29,00

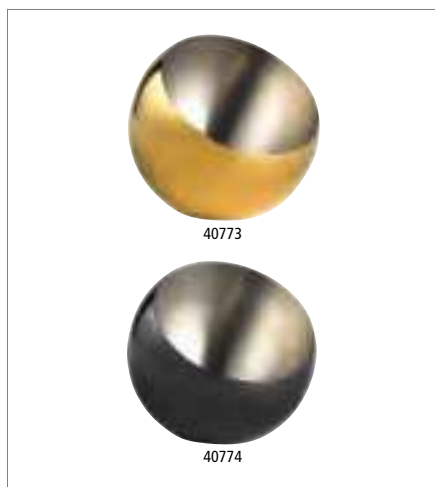

Schale „SPHERE“

bowl
cuenco
bol



innen: mattiert / inside: matt / interior: mate / intérieur: mat

	Ø cm	↑ cm	ltr.	Farbe / Colour	€
40773	16	15	0,8	gold	23,00
40774	16	15	0,8	gunmetal	23,00

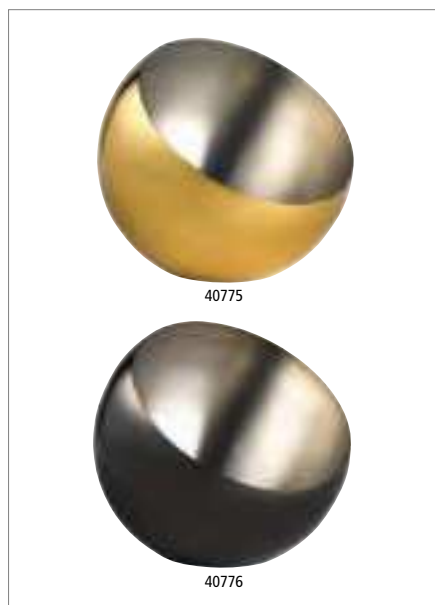

Schale „SPHERE“

bowl
cuenco
bol



innen: mattiert / inside: matt / interior: mate / intérieur: mat

	Ø cm	↑ cm	ltr.	Farbe / Colour	€
40775	24	21	2	gold	34,00
40776	24	21	2	gunmetal	34,00

PERFECTO

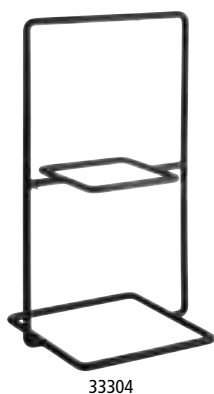
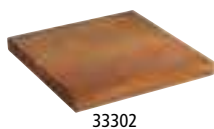

2-stufige Etagère „PERFECTO SMALL“

2-tier tray
bandeja dos alturas
étagère carré 2 hauteurs



3-teiliges Set, bestehend aus:

- 1 Buffetständer, Metall, PVC, schwarz, 23 x 19 cm, H: 40,5 cm
- 2 Bretter aus Eichenholz, geölt, 20 x 20 cm, H: 2 cm

3 pcs., consisting of:

- 1 buffet stand, metal, PVC, black, 23 x 19 cm, h: 40,5 cm
- 2 boards, oiled oak, 20 x 20 cm, h: 2 cm

set de 3, compuesto por:

- 1 soporte buffet, metal, PVC, negro, 23 x 19 cm, a: 40,5 cm
- 2 tablas de roble, aceitadas, 20 x 20 cm, a: 2 cm

set de 3, composé de :

- 1 support de buffet, métal, PVC, noir, 23 x 19 cm, h: 40,5 cm
- 2 planches en bois de chêne, huilées, 20 x 20 cm, h: 2 cm

	cm	↑ cm	€
33300	20 x 23	40,5	52,00

Brett aus Eichenholz / oak board / tabla de roble / planche en chêne

	cm	↑ cm	€
33302	20 x 20	2	15,00

Buffetständer / buffet stand / soporte de buffet / support de buffet

	cm	↑ cm	€
33304	19 x 23	40,5	25,00



Präsentationsmöglichkeit
presentation example

4 tlg.
4 pcs.

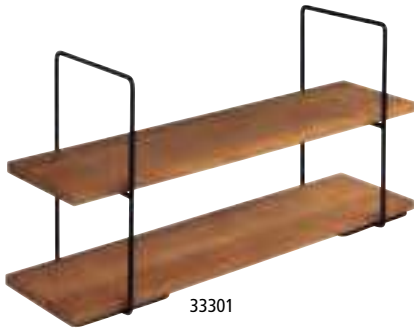

33301



33303



33304

2-stufige Etagère „PERFECTO LARGE“

2-tier tray
bandeja dos alturas
étagère carré 2 hauteurs



4-teiliges Set, bestehend aus:

- 2 Buffetständer, Metall, PVC, schwarz, 23 x 19 cm, H: 40,5 cm
- 2 Bretter aus Eichenholz, geölt, 80 x 20 cm, H: 2 cm

4 pcs., consisting of:

- 2 buffet stands, metal, PVC, black, 23 x 19 cm, h: 40,5 cm
- 2 boards, oiled oak, 80 x 20 cm, h: 2 cm

set de 4, compuesto por:

- 2 soportes buffet, metal, PVC, negro, 23 x 19 cm, a: 40,5 cm
- 2 tablas de roble, aceitadas, 80 x 20 cm, a: 2 cm

set de 4, composé de :

- 2 supports de buffet, métal, PVC, noir, 23 x 19 cm, h: 40,5 cm
- 2 planches en bois de chêne, huilées, 80 x 20 cm, h: 2 cm

	cm	↑ cm	€
33301	80 x 23	40,5	160,00

Brett aus Eichenholz / oak board / tabla de roble / planche en chêne

	Ø cm	↑ cm	€
33303	80 x 20	2	58,00

Buffetständer / buffet stand / soporte de buffet / support de buffet

	cm	↑ cm	€
33304	19 x 23	40,5	25,00



Präsentationsmöglichkeit
presentation example



Präsentationsmöglichkeit 3 Buffetständer + 4 Bretter
presentation example 3 buffet stands / 4 boards

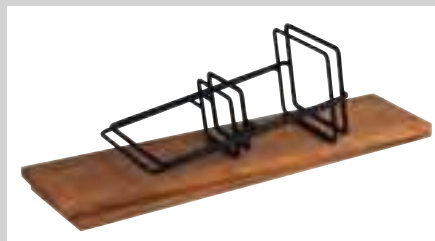

platzsparend
space saving



SERVING STANDS



2-stufige Etagère

2-tier étagère
cesta doble 2 alturas
étagère 2 paniers

oberer Korb (Ø 22 cm, H: 6 cm), unterer Korb (Ø 26 cm, H: 8 cm)
upper basket (Ø 22 cm, H: 6 cm), lower basket (Ø 26 cm, H: 8 cm)
cesta superior (Ø 22 cm, H: 6 cm), cesta inferior (Ø 26 cm, H: 8 cm)
corbeille supérieure (Ø 22 cm, H: 6 cm), corbeille inférieure (Ø 26 cm, H: 8 cm)



	Ø cm	↑ cm	€
30335	26	48	42,00



Präsentationsmöglichkeiten
presentation examples

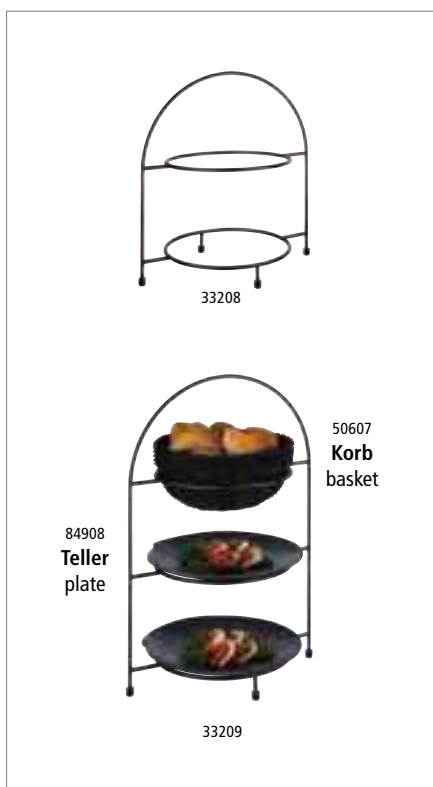

Serviergestell „INDUSTRIAL“

servicing stand
soporte platos
présentoir à assiettes

für Teller max. Ø 27 cm, innerer Ring Ø 18 cm, Lieferung ohne Teller
for plates max. Ø 27 cm, circle inside Ø 18 cm, delivery without dishes
para platos máx. Ø 27 cm, aro interior Ø 18 cm, se entrega sin platos
pour assiettes Ø 27 cm maxi., anneau intérieur Ø 18 cm, livré sans assiettes



	cm	↑ cm	passend für Tellerabdeckhauben / suitable for plate covers	€
33208	29 x 19,5	30	2 Teller Ø 27 cm innerer Ring Ø 18 cm	11051, 11052 31,00
33209	29 x 19,5	43	3 Teller Ø 27 cm innerer Ring Ø 18 cm	11051, 11052 39,00

**Serviergestell**

serving stand
soporte platos
présentoir à assiettes



für 3 Teller max. Ø 27 cm, innerer Ring Ø 18 cm
for 3 plates max. Ø 27 cm, circle inside Ø 18 cm
para 3 platos Ø 27 cm, aro interior Ø 18 cm
pour 3 assiettes maxi Ø 27 cm, anneau intérieur Ø 18 cm

	cm	↑ cm	€
33217	33 x 24	43	52,00

für 2 Teller max. Ø 27 cm, innerer Ring Ø 18 cm, Lieferung ohne Teller
for 2 plates max. Ø 27 cm, circle inside Ø 18 cm, without dishes
para 2 platos Ø 27 cm, aro interior Ø 18 cm, se entrega sin platos
pour 2 assiettes maxi Ø 27 cm, anneau intérieur Ø 18 cm, livré sans assiettes

	cm	↑ cm	€
33214	33 x 23,5	30	41,00

für 3 Teller max. Ø 17 cm, innerer Ring Ø 10,5 cm
for 3 plates max. Ø 17 cm, circle inside Ø 10,5 cm
para 3 platos Ø 17 cm, aro interior Ø 10,5 cm
pour 3 assiettes maxi Ø 17 cm, anneau intérieur Ø 10,5 cm

	cm	↑ cm	€
33216	22,5 x 16,5	25,5	32,80

**Serviergestell**

serving stand
soporte platos
présentoir à assiettes



für 3 Teller max. Ø 17 cm, innerer Ring Ø 10,5 cm
for 3 plates max. Ø 17 cm, circle inside Ø 10,5 cm
para 3 platos Ø 17 cm, aro interior Ø 10,5 cm
pour 3 assiettes maxi Ø 17 cm, anneau intérieur Ø 10,5 cm

	cm	↑ cm	Farbe / Colour	€
33215	18,5 x 15,5	26		25,60
33211	18,5 x 15,5	26		28,00

für 3 Teller max. Ø 27 cm, innerer Ring Ø 18 cm
for 3 plates max. Ø 27 cm, circle inside Ø 18 cm
para 3 platos Ø 27 cm, aro interior Ø 18 cm
pour 3 assiettes maxi Ø 27 cm, anneau intérieur Ø 18 cm

	cm	↑ cm	Farbe / Colour	€
33220	29 x 19,5	43		42,00
33212	29 x 19,5	43		45,00

**Etagère „FINESSE“**

etagère
frutero
étagère



vergoldeter Messing-Kugelgriff, einfache Montage
gold plated knob, easy to assemble
botón dorado, fácil de montar
bouton doré, montage facile

	Ø cm	↑ cm		€
33248	48 / 38 / 32	50	3-stufig / 3-tier 3 alturas / 3 niveaux	99,00
33238	38 / 32	30	2-stufig / 2-tier 2 alturas / 2 niveaux	62,00

SERVING STANDS



2-stufige Etagère „IRON“

2-tier tray
bandeja con dos alturas
étagère carré 2 hauteurs

1 Gestell aus schwarzem Metall
2 Akazienholzplatten: Ø 23 cm, H: 1,5 cm / Ø 30 cm, H: 2,5 cm
2 Beschriftungsschilder 15 x 10,5 cm

1 black metal frame
2 acacia wood panels: Ø 23 cm, H: 1,5 cm / Ø 30 cm, H: 2,5 cm
2 inscription labels 15 x 10.5 cm

1 soporte metálico negro
2 tablas de madera de acacia: Ø 23 cm, H: 1,5 cm / Ø 30 cm, H: 2,5 cm
2 etiquetas de inscripción 15 x 10,5 cm

1 support métallique noir
2 panneaux en bois d'acacia: Ø 23 cm, H: 1,5 cm / Ø 30 cm, H: 2,5 cm
2 étiquettes d'inscription 15 x 10,5 cm



	cm	↑ cm	€
30334	47 x 30	44	80,00

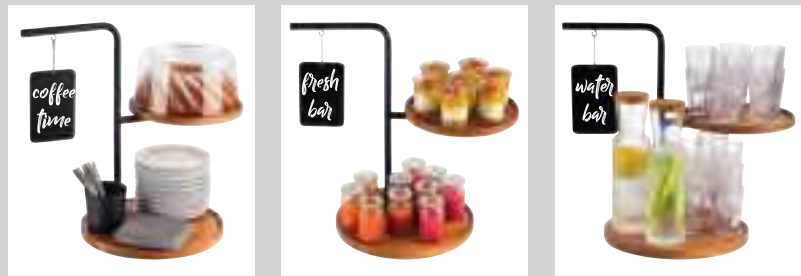

Präsentationsmöglichkeiten
presentation examples



2-stufige Etagère

2-tier tray
soporte 2 alturas
étagère 2 niveaux

1 Gestell aus schwarzem Metall, mit Antirutschfüßchen,
2 herausnehmbare Bretter aus geöltem Akazienholz (34,5 x 20,5 x 1,5 cm) / (34,5 x 13 x 1,5 cm)
8 Beschriftungsschilder (6 x 4 cm)

1 frame made of black metal with non-slip feet,
2 removable trays made of acacia wood (34,5 x 20,5 x 1,5 cm) / (34,5 x 13 x 1,5 cm)
8 labelling plates (6 x 4 cm)

1 soporte metálico, negro con pies antideslizantes,
2 bandejas extraíbles de madera de acacia (34,5 x 20,5 x 1,5 cm) / (34,5 x 13 x 1,5 cm)
8 etiquetas (6 x 4 cm)

1 support métallique noir avec pieds antidérapants,
2 planches amovibles en bois d'acacia (34,5 x 20,5 x 1,5 cm) / (34,5 x 13 x 1,5 cm)
8 étiquettes (6 x 4 cm)



	cm	↑ cm	€
30339	35,5 x 21	40	59,00



Präsentationsmöglichkeiten
presentation examples



mit Antirutschfüßchen
with non-slip feet

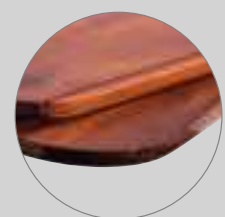

geöltes Akazienholz
oiled acacia wood



1 x Gestell / 1 x frame



2 x Korb / 2 x basket

5 tlg.
5 pcs.

2 x Tablett / 2 x tray



Haube / cover 11056



Korb / basket 30337



Tablett / tray 85099



Tablett / tray 30338

2-stufige Etagère „ALL-ROUNDER“, 5-teilig

2-tier tray, 5 pcs.

soporte 2 alturas, set de 5

étagère 2 niveaux, set de 5

5 teiliges Set:

- 1 Gestell aus schwarzem Metall, mit Antirutschfüßchen,
- 2 Körbe aus Metall schwarz je 29 x 16 cm, H: 7 cm,
- 2 herausnehmbare Bretter aus geöltem Akazienholz je 28,5 x 15,5 cm, H: 1,5 cm

5 pcs.:

- 1 frame made of black metal with non-slip feet,
- 2 removable baskets of black metal each 29 x 16 cm, H: 7 cm,
- 2 boards of oiled acacia wood each 28,5 x 15,5 cm, H: 1,5 cm

set de 5:

- 1 soporte metálico, negro con pies antideslizantes,
- 2 cestas metálicas negras, cada una de 29 x 16 cm, H: 7 cm,
- 2 tablas de madera de acacia aceiteada 28,5 x 15,5 cm, H: 1,5 cm

set de 5:

- 1 support métallique noir avec pieds antidérapants,
- 2 paniers métalliques noirs, chacune 29 x 16 cm, H: 7 cm,
- 2 planches d'acacia huilé, chacune 28,5 x 15,5 cm, H: 1,5 cm

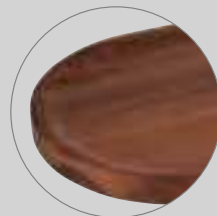

	cm	↑ cm	€
30336	31 x 17	37,5	64,00

Präsentationsmöglichkeiten
presentation examplesgeöltes Akazienholz
oiled acacia woodmit Antirutschfüßchen
with non-slip feet

Korb / basket / cesta / corbeille

	cm	↑ cm	Farbe / Colour	€
30337	29 x 16	7	■	19,00

Servierbrett aus Akazienholz / serving board of acacia wood / tabla de servir de madera de acacia / planche de service en bois d'acacia

	cm	↑ cm	Farbe / Colour	€
30338	28,5 x 15,5	3,5	■	8,20

Melamintablett / melamine tray / bandeja de melamina / plateau en mélamine

	cm	↑ cm	Farbe / Colour	€
85099	28,0 x 15,5	1,0	■	13,60

Haube / cover / campana / cloche

	cm	↑ cm	€
11056	26,0 x 12,0	10,0	6,00

SERVING STANDS



Buffetgestell „BIRDCAGE“

buffet stand
soporte para buffet
présentoir buffet



Gestell aus schwarzem Metall, inklusive 2 Akazienholzplatten

black metal frame, incl. 2 acacia wood panels
soporte metálico negro, con 2 tablas de madera de acacia
support métallique noir, avec 2 panneaux en bois d'acacia

	Ø cm	↑ cm	€
33206	26	54	55,00

Ersatz-Holzplatte

spare wooden panel
tabla de madera de recambio
panneau en bois de rechange

	Ø cm	↑ cm	€
33207	25	1	15,40



Brot- und Obstkorb

basket for bread or fruits
cesta para pan o fruta
corbeille à pain ou à fruits



inklusive Tasche aus Baumwolle, beige grau, maschinenwaschbar bis 30 Grad

incl. bag made of cotton, beige, grey, machine washable up to 30°C
bolsa incluida, de algodón, beige, gris, lavable a máquina hasta 30°C
sac inclus en coton, beige, gris, lavable en machine jusqu'à 30°C

	Ø cm	↑ cm	€
30209	27,5	18,5	32,00



stapelbar
stackable



rutschfest inklusive Klipp
non-slip, includes clip

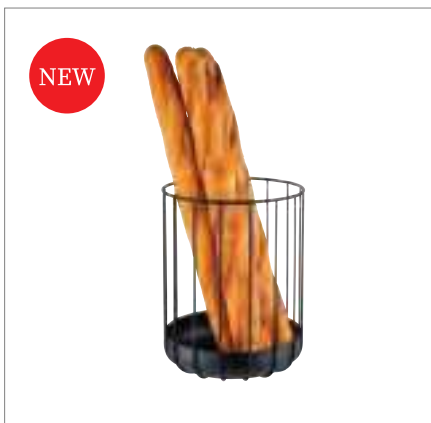

Brot- und Obstkorb „URBAN“

basket for bread or fruits
cesta para pan o fruta
corbeille à pain ou à fruits



Gestell aus schwarzem Metall

black metal frame
soporte metálico negro
support métallique noir

	Ø cm	↑ cm	€
30211	22,5	28	26,00

NEW

**Eierkorb „OVO“**

egg basket
cesta de huevos
panier à oeufs

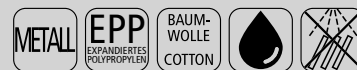

Gestell aus Metall, EPP-Box sorgt für perfekte Wärmeisolierung, Eier werden lange warm gehalten, inklusive waschbarem Stoffeinsatz

metal frame, EPP box ensures perfect heat insulation, Eggs are kept warm for a long time, including washable fabric insert
estructura de metal, la caja de EPP garantiza un perfecto aislamiento térmico, los huevos se mantienen calientes durante mucho tiempo, incluye inserto de tela lavable
structure en métal, la boîte EPP assure une isolation thermique parfaite, les oeufs sont maintenus au chaud pendant longtemps, insert en tissu lavable inclus

	Ø cm	↑ cm	€
30480	23	31	29,00

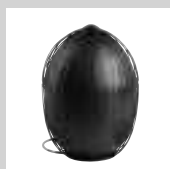

für ca. 35 Eier
for approx. 35 eggs

**Serviergestell, 2-stufig**

servicing stand, 2-tier
soporte platos, 2 alturas
présentoir, 2 hauteurs



3 tlg. Set: 1 Gestell aus Akazienholz, 2 Schieferplatten

3 pcs.: 1 stand acacia wood, 2 slate trays

set de 3: 1 soporte madera de acacia, 2 bandejas de pizarra

set de 3: 1 présentoir en bois d'acacia, 2 plateaux en ardoise naturelle



zusammenklappbar
foldable

	cm	↑ cm	€
00958	36,5	34 x 26,5	38,80

**3-stufige Etagère**

3-tier tray
bandeja con tres alturas
étagère carré 3 hauteurs



Naturschieferplatte, Akazienholz

natural slate tray, wood akazie

bandeja de pizarra natural, madera de acacia

plateau ardoise naturelle, bois d'acacia

	Ø cm	↑ cm	* mm	€
00960	30 / 25 / 20	34	6 - 9	30,00

**2-stufige Etagère**

2-tier tray
bandeja dos alturas
étagère carré 2 hauteurs



Naturschiefer

natural slate tray

bandeja de pizarra natural

plateau ardoise naturelle

	Ø cm	↑ cm	* mm	€
00989	25 / 20	24	6 - 9	15,30

SERVING STANDS



Brezel- oder Wurstständer

pretzel-/ sausage stand
soporte para pretzels/ embutidos
support à bretzel ou à saucissons



Verkaufsständer Buchenholz versiegelt, bestens geeignet für die Präsentation von Brezeln, Würstchen, etc., Fuß Ø 22 cm

beech wood, ideal to present pretzels, sausages, etc., base Ø 22 cm

soporte de madera de haya, ideal para presentar pretzels, salchicas, etc., base Ø 22 cm
support en bois de hêtre, pour la présentation de bretzels, saucisses, etc. pied Ø 22 cm

	Ø cm	↑ cm	€
79553	28	50	21,00

Hygieneschutz für Brezelständer / hygienic cover / campana higiénica antialiento / pare-haleine

	cm	↑ cm	€
11557	20 x 20 x 20	50	22,00
11558	15 x 20 x 15	50	20,00



Hobel für Käse und Schokolade

cheese / choco curler
rizador para queso y chocolate
frisette pour fromage et chocolat



3-teilig: Platte Buchenholz versiegelt Ø 22 cm mit senkrechtem Stift + Hobel 7 cm + Haube Ø 15 x 10 cm, für Käse und Schokolade

3 pcs.: wooden base Ø 22 cm with vertical bolt + plough 7 cm + cover Ø 15 x 10 cm, for cheese and chocolate

set de 3: base de madera Ø 22 cm, con eje vertical de 7 cm + campana Ø 15 x 10 cm, para „rizar“ queso y chocolate

set de 3: base bois Ø 22 cm, axe vertical ht. 7 cm, cloche Ø 15 x ht 10 cm, pour „friser“ le fromage ou le chocolat

	Ø cm	↑ cm	€
50002	22	15	21,00

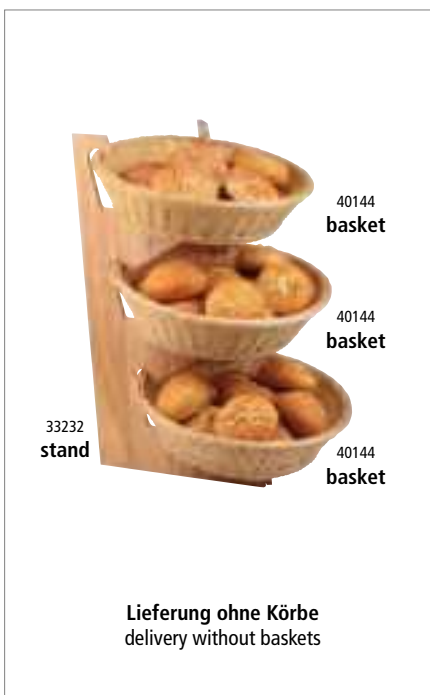

Buffetgestell

buffet stand
soporte para buffet
présentoir buffet



3-stufig, Rubberwood, geeignet für Körbe, platzsparend zusammenklappbar

3-tier, rubberwood, usable for baskets, can be pushed together for place saving

3 alturas, madera de caucho, apto para cestas, se puede plegar para ahorrar espacio

3 hauteurs, bois d'hévéa, pour corbeilles, la structure s'ouvre ou se ferme pour réduire l'encombrement

	cm	↑ cm	€
33232	59 x 30,5	59	22,00

Tisch- und Buffetkorb, rund „ECONOMIC“ / buffet basket, round / cesta de buffet redonda / corbeille de buffet ronde

	Ø cm	↑ cm	€
40144	39,0	10,0	19,00

**Buffetständer „ACACIA“**

buffet stand
soporte para buffet
présentoir buffet

Akazienholz geölt / acacia wood oiled / madera de acacia aceitada / bois d'acacia huilé



	Ø cm	↑ cm		€
15620	20,0	10,5		31,00
15621	30,5	15,0		53,00
15622	30,5	20,0		58,00

Frischhaltehaube / cover / campana / cloche

	Ø cm	↑ cm	fits to	€
06520	30	22	15621, 15622	37,00

Frischhaltehaube / cover / campana / cloche

	Ø cm	↑ cm	fits to	€
06512	30	11,5	15621, 15622	8,20

**Buffetständer „ACACIA“**

buffet stand
soporte para buffet
présentoir buffet

Akazienholz geölt / acacia wood oiled / madera de acacia aceitada / bois d'acacia huilé



	cm	↑ cm	GN	€
15623	53 x 16,2	20	2/4	63,00

**GN Abdeckhaube / GN cover / GN campana/ GN cloche**

	cm	↑ cm	GN	€
11044	53 x 16,2	10,5	2/4	23,00

CUTTING BOARDS



Brotschneidebrett „PROFI“

cutting board
tabla de cortar
planche à découper



Eichenholz / oak wood / mader de roble / bois de chêne

	cm	↑ cm		€
00806	58 x 37,5	4		118,00

NEW



Brotschneidebrett „VALO“

cutting board
tabla de cortar
planche à découper



Eichenholz (geölt), mit Antirutsch-Füßchen

oak wood (oiled), with non-slip feet
mader de roble (acweitada), con pies antideslizantes
bois de chêne (huilé), avec pieds antidérapants

	cm	↑ cm	GN	€
00764	53 x 32,5	3,5	1/1	100,00



NEW

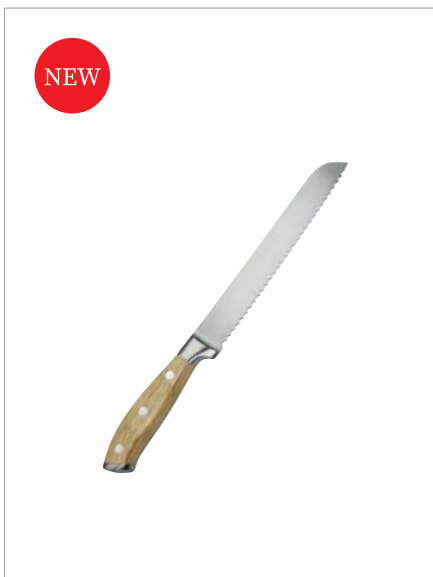

Brotmesser

bread knife
cuchillo para pan
couteau à pain



Brotmesser aus rostfreiem Edelstahl, dreifach genietet, mit Griff aus Buchenholz

bread knife made of stainless steel, triple riveted, with beech wood handle
cuchillo para pan de acero inoxidable, triple remachado, con mango de mader de haya
couteau à pain en acier inox, triplement riveté, avec manche en bois de hêtre

	→ cm	€
88990	34	16,00

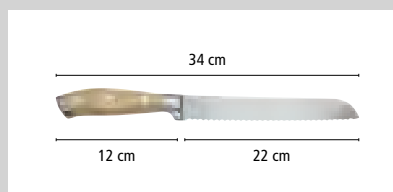



Brotschneidebrett

cutting board
tabla de cortar
planche à découper

Walnussholz / walnut wood / madera de nogal / bois de noyer



	cm	↑ cm	GN	€
00911	35,4 x 32,5	3,5	2/3	77,00



praktisches Krümelfach
practical crump shelf



Brotschneidebrett „LETTER“

cutting board
tabla de cortar
planche à découper

Akazienholz / acacia wood / madera de acacia / bois d'acacia



	cm	↑ cm	GN	€
00886	48 x 34	3,5		34,00



praktisches Krümelfach
practical crump shelf



00885

Brotschneidebrett

cutting board
tabla de cortar
planche à découper

Akazienholz / acacia wood / madera de acacia / bois d'acacia



	cm	↑ cm	GN	€
00883	47,5 x 32,0	2		30,00
00884	53,0 x 32,5	2	1/1	31,00
00885	60,0 x 40,0	2		36,00



praktisches Krümelfach
practical crump shelf



00957

Brotschneidebrett

cutting board
tabla de cortar
planche à découper

Rubberwood / rubberwood / madera de caucho / bois d'hévéa



	cm	↑ cm	GN	€
00955	47,5 x 32,0	2		27,00
00956	53,0 x 32,5	2	1/1	29,00
00957	60,0 x 40,0	2		34,00



praktisches Krümelfach
practical crump shelf

CUTTING BOARDS



83615
Tablett

00954
Box

00953
Schneidebrett



Tablett „BROTSTATION“

tray
bandeja
plateau

mit Antirutschfüßchen
with non-slip feet
con pies antideslizantes
avec pieds antidérapants



	cm	↑ cm	€
83615	59,5 x 35,5	3,5	42,00



00953
Schneidebrett

83615
Tablett

Brotschneidebrett „BROTSTATION“

cutting board
tabla de corte
planche à découper

Buchenholz
beech
haya
hêtre



	cm	↑ cm	€
00953	52 x 34	2	37,00

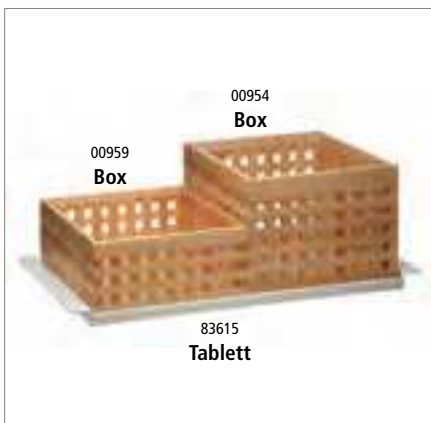

00954
Box

00959
Box

83615
Tablett

Box „BROTSTATION“

box
caja de pan
boîte à pain

Buchenholz
beech
haya
hêtre



	cm	↑ cm	€
00959	34 x 26	12,5	52,00
00954	34 x 26	20,0	64,00



Schneidebrett

cutting board
tabla de cortar
planche à découper

Eichenholz, geölt, mit Antirutsch-Füßchen

oak wood oiled, with non-slip feet
madera de roble aceitada, con pies antideslizantes
bois de chêne huilé, avec pieds antidérapants



	cm	↑ cm	Farbe / Colour	€
00762	58,5 x 35	2		72,00



Präsentationsmöglichkeit 2-teilig
presentation example 2-piece

Eichenholz
oak wood



Schneidebrett

cutting board
tabla de cortar
planche à découper

Walnuss, geölt, mit Antirutsch-Füßchen

walnut wood oiled, with non-slip feet
madera de nogal aceitada, con pies antideslizantes
bois noyer huilé, avec pieds antidérapants



	cm	↑ cm	Farbe / Colour	€
00763	58,5 x 35	2		90,00

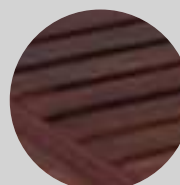

Präsentationsmöglichkeit 2-teilig
presentation example 2-piece

Walnuss
walnut wood



Tablett / Basis

tray / base
bandeja / base
plateaux / base

Melamin, schwarz, mit Antirutsch-Füßchen, passendes Schneidebrett Nr. 762, 763

melamine, black, with non-slip feet, suitable cutting board art. 762, 763
melamina, negro, con pies antideslizantes, tabla de cortar adecuada art. 762, 763
mélamine, noir, avec pieds antidérapants, planche à découper appropriées art. 762, 763



	cm	↑ cm	€
85225	67 x 38	4	78,00

SQUARE



GN 1/1 Buffetbrett „SQUARE“

GN 1/1 buffet board
GN 1/1 tabla de buffet
GN 1/1 planche de buffet

aus geöltem Eichenholz
made of oiled oak wood
de madera de roble aceitada
en bois de chêne huilé



	cm	↑ cm	GN	€
00758	53,0 x 32,5	2,5	1/1	43,00

passende Haube / suitable cover / campana adecuada / cloche appropriée

	cm	↑ cm	GN	€
11075	53,0 x 32,5	19	1/1	62,00



Haube fixiert sich auf dem Brett, rutschfest
cover fixes itself on the board, non-slip

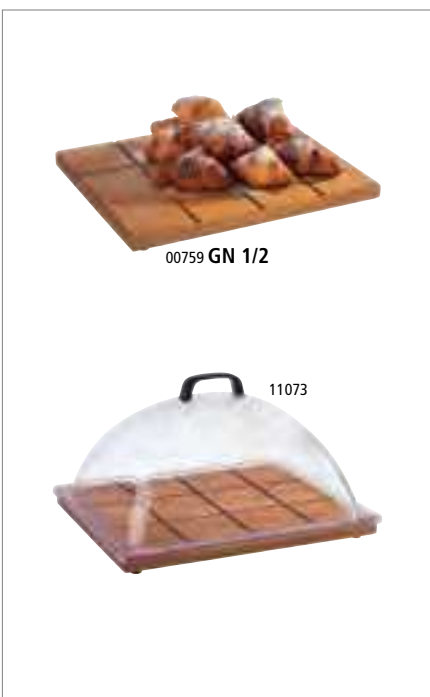

GN 1/2 Buffetbrett „SQUARE“

GN 1/2 buffet board
GN 1/2 tabla de buffet
GN 1/2 planche de buffet

aus geöltem Eichenholz
made of oiled oak wood
de madera de roble aceitada
en bois de chêne huilé



	cm	↑ cm	GN	€
00759	32,5 x 26,5	2,5	1/2	28,00

passende Haube / suitable cover / campana adecuada / cloche appropriée

	cm	↑ cm	GN	€
11073	33 x 28	17	1/2	29,00



Haube fixiert sich auf dem Brett, rutschfest
cover fixes itself on the board, non-slip



GN 2/4 Buffetbrett „SQUARE“

GN 2/4 buffet board
GN 2/4 tabla de buffet
GN 2/4 planche de buffet

aus geöltem Eichenholz
made of oiled oak wood
de madera de roble aceitada
en bois de chêne huilé



	cm	↑ cm	GN	€
00760	53,0 x 16,2	2,5	2/4	28,00



Präsentationsmöglichkeit
presentation example

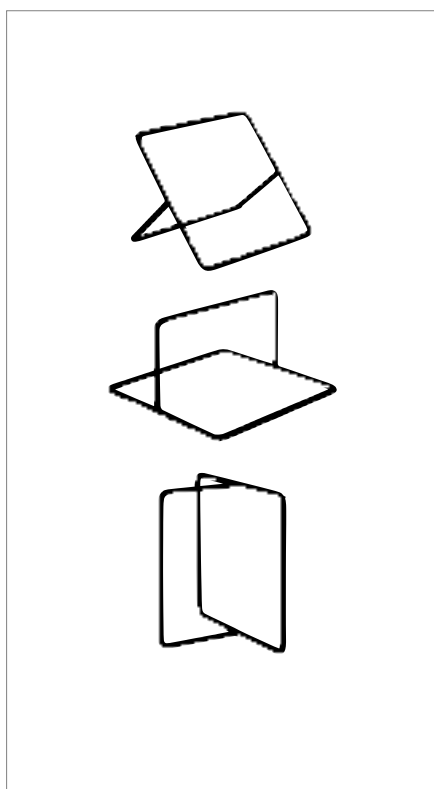

Buffetständer „SQUARE“

buffet stand
soporte para buffet
présentoir buffet

Metall, mit schwarzer Antirutschbeschichtung
metal, with black anti-slide coating
metal, con revestimiento antideslizante negro
métal, avec revêtement antidérapant noir



	cm	↑ cm	€
33305	12 x 12	7	6,50



Präsentationsmöglichkeit 2-teilig
presentation example 2-piece



GN Rolltophaube

GN rolltop cover
GN campana rolltop
GN cloche rolltop

patentiert, passend für GN-Behälter, -Tablets, etc., leichtgängig auf- und zuklappbar 90°
patented, suitable for GN containers, GN trays, etc. 90° opening
patentada, para cubetas GN, bandejas GN, etc. fácil de abrir y cerrar 90°
brevetée, pour bacs GN, plateaux GN, etc. s'ouvre et se ferme facilement à 90°



	cm	↑ cm	GN	€
11060	53,0 x 32,5	19	1/1	64,00
11061	32,5 x 26,5	15	1/2	59,00

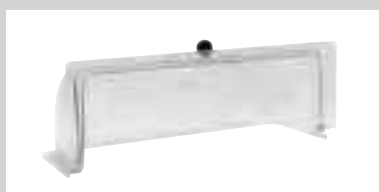

Designgriff
design handle

BUFFET BOARDS „PROFI“



Buffetbrett „PROFI“ buffet board tabla de buffet planche de buffet

aus geöltem Eichenholz, Safrinne, mit Antirutschfüßchen

made of oiled oak, with juice groove and non-slip feet

de madera de roble aceitada, con ranura para líquidos y pies antideslizantes

en bois chêne huilé, avec rigole et pieds antidérapants



	Ø cm	↑ cm	€
00805	33	4,5	73,00
00816	39	4,5	118,00

Frischhaltehaube / cover / campana / cloche



	Ø cm	↑ cm	fits to	€
06512	30	11,5	00805	8,20

Frischhaltehaube / cover / campana / cloche



	Ø cm	↑ cm	fits to	€
06520	30	22	00805	37,00
06521	36	27	00816	74,00



Buffetbrett „PROFI“ buffet board tabla de buffet planche de buffet

aus geöltem Eichenholz, Safrinne, mit Antirutschfüßchen

made of oiled oak, with juice groove and non-slip feet

de madera de roble aceitada, con ranura para líquidos y pies antideslizantes

en bois chêne huilé, avec rigole et pieds antidérapants



	cm	↑ cm	€
00807	38 x 32,0	4,5	78,00
00806	58 x 37,5	4,5	118,00

Rolltophaube / rolltop cover / campana rolltop / cloche rolltop



	Ø cm	↑ cm	fits to	GN	€
11016	53,0 x 32,5	19	00806	1/1	64,00

MODULO



Buffet Box „MODULO“

buffet box
caja buffet
boîte à buffet

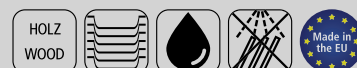

Eichenholz, geölt, Innenmaße: 15,5 x 10 cm
oak wood oiled, interior dimensions: 15,5 x 10 cm
madera de roble aceitada, medidas int.: 15,5 x 10 cm
bois de chêne huilé, dimensions int.: 15,5 x 10 cm

	cm	↑ cm	€
11728	17,5 x 15,5	12,5	28,00



stapelbar
stackable

Präsentationsmöglichkeit
presentation example



Buffet Box „MODULO“

buffet box
caja buffet
boîte à buffet

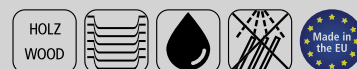

aus geöltem Eichenholz, 2 Fächer je: 25 x 16 cm, mit 2 Griffmulden
made of oiled oak wood, 2 compartments: each 25 x 16 cm, with 2 recessed grips
de madera de roble aceitada, 2 compartimentos de 25 x 16 cm, con 2 asas empotradas
en bois de chêne huilé, 2 compartiments: chacun 25 x 16cm, avec 2 poignées encastées

	cm	↑ cm	€
11729	35 x 31	12,5	58,00



stapelbar
stackable

Präsentationsmöglichkeit
presentation example

MULTI RACKS



4-tlg.
4 pcs.

5-tlg.
5 pcs.

11413

11414

11411

Gestell „MULTI RACK“

rack
marco
châssis



- 1 Gestell schwarz, matt
- Schütten aus grau gefrostedem Kunststoff, je ca. 1 Liter
- 1 frame matt
- bowls frosted plastic, approx. 1 liter
- 1 soporte mate
- cuencos de plástico glaseado, aprox. 1 litro
- 1 support mat
- bols en plastique mat, approx. 1 litre

	cm	↑ cm	ltr.	€
11413	19 x 24	41	1	50,00
11414	19 x 31	53	1	64,00

Ergänzung für alle Gestelle „MULTI RACK“

supplement for all racks „MULTI RACK“
suplemento para todas las estanterías „MULTI RACK“
complément pour tous les supports „MULTI RACK“



Schütte / canister / cuenco / bol

	cm	↑ cm	ltr.	€
11411	19,5 x 16,5	10,5	1	7,20



4-tlg.
4 pcs.

5-tlg.
5 pcs.

11444

11446

11455

Gestell „MULTI RACK“

rack
marco
châssis



- 1 Gestell matt poliert
- Schütten aus transparent gefrostedem Kunststoff, je ca. 1 Liter
- 1 frame matt polished
- bowls frosted plastic, approx. 1 liter
- 1 soporte pulido mate
- cuencos de plástico glaseado, aprox. 1 litro
- 1 support poli mat
- bols en plastique mat, approx. 1 litre

	cm	↑ cm	ltr.	€
11444	19 x 24	41		48,00
11446	19 x 31	53		62,00

Ergänzung für alle Gestelle „MULTI RACK“

supplement for all racks „MULTI RACK“
suplemento para todas las estanterías „MULTI RACK“
complément pour tous les supports „MULTI RACK“



Schütte / canister / cuenco / bol

	cm	↑ cm	ltr.	€
11455	19,5 x 16,5	10,5	1,0	7,20



Dressingtopf „FROSTFIRE“

dressing pot
salsera
pot à sauce

Antihafbeschichtung
non stick coating
antiadherente
revêtement anti-adhésif



	Ø cm	↑ cm	ltr.	Farbe / Colour	€
36140	11,5 / 11	15	1,4	black / silver	17,60



Dressingtopf-Station

wooden station for 3 dressing pots
expositor de madera para 3 salseras
présentoir en bois pour 3 pots à sauce

inklusive 3 Beschriftungsschilder aus Metall / including 3 metal labels / con 3 etiquetas de metal / avec 3 étiquettes métalliques



	cm	↑ cm	fits to	€
84863	40 x 16	9	83311, 83867	31,00



Dressingtopf „PASTELL“

dressing pot
salsera
pot à sauce



	cm	↑ cm	ltr.	€
84860	13	19,5	1,5	22,00



Dressingtopf „CASUAL“

dressing pot
salsera
pot à sauce



	cm	↑ cm	ltr.	Farbe / Colour	€
83867	12	21,5	1	white	29,80
83868	12	21,5	1	black	29,80



Dressingtopf

dressing pot
salsera
pot à sauce

Deckel mit Löffelaussparung / cover notched for spoon / tapa agujereada para el cucharón / couvercle avec espace pour la louche



	Ø cm	↑ cm	ltr.	€
83310	17,0	15	2,0	27,00
83311	13,0	13	0,8	14,80

JARS



NEW



82268



82269

Vorratsglas mit Deckel „COOKIEGO“

jar with lid
bote con tapa
pot en verre avec couvercle

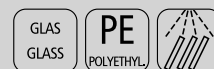

inklusive Glasdeckel mit Dichtung, somit bleibt Ihre Ware frisch
including glass lid with seal, thus, your goods remain fresh
con tapa de vidrio con junta, por lo tanto, sus productos permanecen frescos
y compris couvercle en verre avec joint, ainsi, vos marchandises restent fraîches

	Ø cm	↑ cm	ltr.	€
82268	17,0	24,5	3,0	14,00
82269	17,5	27,0	3,7	16,00

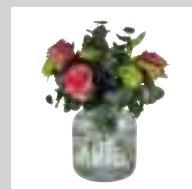
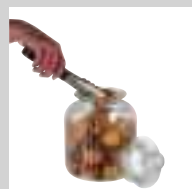
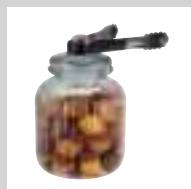



82265 1 ltr.



82266 1,2 ltr.



82267 1,5 ltr.

Vorratsglas mit Deckel „NOTE“

jar with lid
bote con tapa
pot en verre avec couvercle

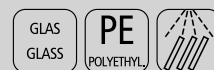

inklusive Glasdeckel mit Dichtung und Beschriftungsfeld, somit bleibt Ihre Ware frisch
including glass lid with seal and labeling field, thus, your goods remain fresh
con tapa de vidrio con junta y campo de etiquetado, por lo tanto, sus productos permanecen frescos
y compris couvercle en verre avec joint et le domaine de l'étiquetage, ainsi, vos marchandises restent fraîches

	Ø cm	↑ cm	ltr.	€
82265	11,0	18,0	1,0	7,20
82266	11,5	19,5	1,2	8,00
82267	12,0	21,0	1,5	10,60



Kreidestift zum Beschriften
chalk marker for writing
S. 348



82255 1,0 ltr.



82256 2,0 ltr.



82257 2,5 ltr.

Vorratsglas mit Deckel „WOODY“

jar with lid
bote con tapa
pot en verre avec couvercle



Glasbehälter mit Holzdeckel, aromadichter Verschluss
glass container, aroma-tight screw cap
recipiente de cristal, tapa con cierre hermético para conservar el aroma
récipient en verre, couvercle avec fermeture hermétique pour conserver l'arôme

	cm	↑ cm	ltr.	€
82255	14 x 14	11,0	1,0	11,50
82256	14 x 14	17,0	2,0	12,60
82257	14 x 14	21,5	2,5	14,40



Holzdeckel aus Kiefernholz mit Silikondichtung
wooden lid from pine wood with silicone gasket



Vorratsglas mit Deckel „CLASSIC“

jar with lid
bote con tapa
pot en verre avec couvercle



inklusive Glasdeckel mit Dichtung, somit bleibt Ihre Ware frisch
including glass lid with seal, thus, your goods remain fresh
con tapa de vidrio con junta, por lo tanto, sus productos permanecen frescos
y compris couvercle en verre avec joint, ainsi, vos marchandises restent fraîches

	Ø cm	↑ cm	ltr.	€
82250	11,5	16,0	0,9	7,80
82251	14,0	21,5	2,0	13,20
82252	18,0	26,0	4,0	21,60
82253	20,0	30,0	6,0	25,40

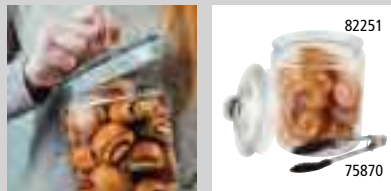

Präsentationsmöglichkeit
presentation example



Vorratsglas mit luftdichtem Klappdeckel

jar with airtight cover
bote con cierre hermético
pot en verre avec fermeture hermétique



	cm	↑ cm	ltr.	€
82328	12 x 12	22	2	9,00

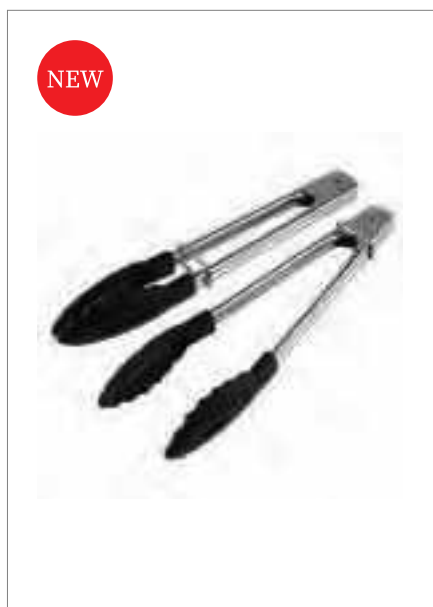

Mini-Universalzange, 2er Set

mini all-purpose tongs, 2 pcs.
mini pinzas multiusos, set de 2
mini pince multi-usages, set de 2



Edelstahl poliert, Greifer aus Polyamid, inklusive Haltering
polished stainless steel, polyamide gripper, including retaining ring
acero inoxidable pulido, pinzas de poliamida, anillo de retención incluido
acier inox poli, pinces en polyamide, anneau de retenue inclus

	→ cm	pcs.	€ / set
75870	18	2	9,00





seitlich gestellt
placed sideways
1 ltr.



hochkant gestellt
placed upright
2,2 ltr.

Vorratsglas mit Deckel

jar with lid
bote con tapa
pot en verre avec couvercle



mit Löffel, Schraubdeckel mit aromadichtem Verschluss, Edelstahlöffel mit magnetischem Silikongriff

tight cover, stainless steel spoon with magnetic silicone handle
tapa a rosca con cierre hermético, cuchara de acero inoxidable con mango de silicona magnético
couvercle à vis avec fermeture hermétique, cuillère en acier inox avec manche de silicone aimanté

	cm	↑ cm	ltr.	€
00636	17 x 12,5	18	1 - 2,2	15,00



seitlich gestellt
placed sideways
1 ltr.



hochkant gestellt
placed upright
2,2 ltr.

Vorratsglas mit Deckel

jar with lid
bote con tapa
pot en verre avec couvercle



mit Schraubdeckel, aromadichtem Verschluss

aroma-tight screw cap
tapa a rosca para conservar el aroma
couvercle à vis pour conserver l'arôme

	cm	↑ cm	ltr.	€
00637	17 x 12,5	18	1 - 2,2	10,00

stapelbar
stackable



11884

11885

Frontklappe
front lid

Universalbox

box / sweetbox
caja dispensadora
boîte distributrice



ideal als Verkaufsbox, mit Frontdeckel

best to present sweets etc., all-purpose, with front lid
la perfecta solución para presentar golosinas, universal, con tapa frontal
la solution idéale pour les friandises et autres, universel, avec couvercle frontal

	cm	↑ cm	Farbe / Colour	€
11884	23 x 14,5	15		14,00
11885	23 x 14,5	15		14,00

5 STARS



Töpfe aus emailiertem Gusseisen leiten nicht nur die Wärme gut, sondern können sie auch lange energieschonend speichern – ideal für den professionellen Einsatz am Buffet!

Cooking pots made of enamelled cast iron not only conduct heat well, but can also store it for a long time while conserving energy - ideal for professional use at the buffet!

Las ollas de hierro fundido esmaltado no sólo conducen bien el calor, sino que también pueden almacenarlo durante mucho tiempo conservando la energía: ¡ideales para un uso profesional en el buffet!

Les marmites en fonte émaillée ne conduisent pas seulement bien la chaleur, mais peuvent aussi la conserver longtemps en économisant de l'énergie - idéal pour une utilisation professionnelle au buffet!

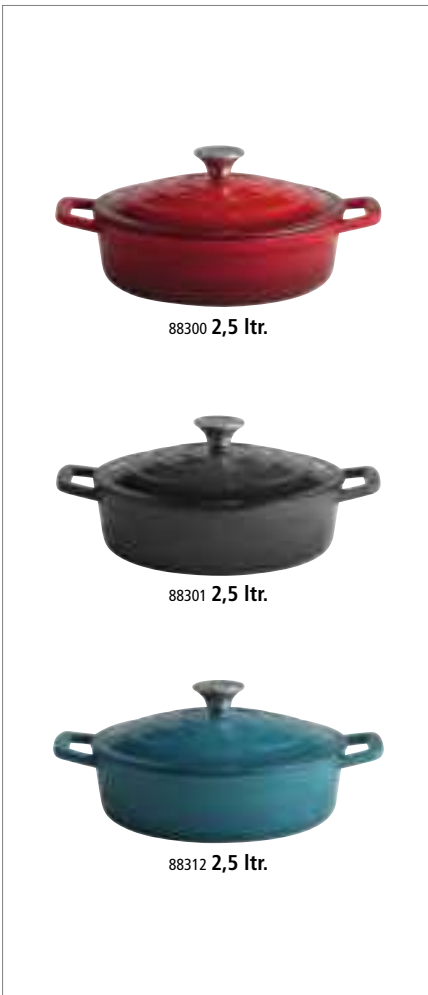

Bräter mit Deckel „5 STARS“ roaster with lid cacerola con tapa cocotte avec couvercle



	Ø cm	↑ cm	ltr.	Farbe / Colour	€
88300	25	7 / 13	2,5		59,00
88301	25	7 / 13	2,5		59,00
88312	25	7 / 13	2,5		59,00



inklusive Deckelhalter
including lid holder



Kochtopf mit Deckel „5 STARS“
 cooking pot with lid
 olla con tapa
 marmite avec couvercle



	Ø cm	↑ cm	ltr.	Farbe / Colour	€
88302	25	11,5 / 17,5	4		64,00
88303	25	11,5 / 17,5	4		64,00
88313	25	11,5 / 17,5	4		64,00



inklusive Deckelhalter
 including lid holder



Bräter mit Deckel „5 STARS“
 roaster with lid
 cacerola con tapa
 cocotte avec couvercle



	Ø cm	↑ cm	ltr.	Farbe / Colour	€
88304	28	7 / 13,5	3		69,00
88305	28	7 / 13,5	3		69,00
88314	28	7 / 13,5	3		69,00



inklusive Deckelhalter
 including lid holder

5 STARS



Kochtopf mit Deckel „5 STARS“ cooking pot with lid olla con tapa marmite avec couvercle



	Ø cm	↑ cm	ltr.	Farbe / Colour	€
88306	28	13 / 20	6		74,00
88307	28	13 / 20	6		74,00
88315	28	13 / 20	6		74,00



inklusive Deckelhalter
including lid holder



Bräter mit Deckel „5 STARS“ roaster with lid cacerola con tapa cocotte avec couvercle



	cm	↑ cm	ltr.	Farbe / Colour	€
88308	33 x 25	11 / 17,5	5		79,00
88309	33 x 25	11 / 17,5	5		79,00
88316	33 x 25	11 / 17,5	5		79,00



inklusive Deckelhalter
including lid holder



88310 3,5 ltr.

88311 3,5 ltr.

88317 3,5 ltr.

Auflaufform „5 STARS“
casserole dish
fuente para gratinar
plat à four



	cm	↑ cm	ltr.	Farbe / Colour	€
88310	33 x 24	6,5	3,5	Red	54,00
88311	33 x 24	6,5	3,5	Black	54,00
88317	33 x 24	6,5	3,5	Teal	54,00



Deckelhalter, 2er Set
lid holder, 2 pcs.

soporte para tapa, set de 2
support de couvercle, set de 2



mit Antirutschbeschichtung, für alle Töpfe mit Deckel einsetzbar, hitzebeständig
with non-slip coating, suitable for all pots with lids, heat-resistant
revestimiento antideslizante, apto para todas las ollas con tapa, resistente al calor
avec revêtement antidérapant, adapté à toutes les casseroles avec couvercle, résistant à la chaleur

	cm	↑ cm	Farbe / Colour	pcs.	€ / set
88320	10,5 x 8,5	3,5	Black	2	10,00



88308 5 ltr.

88315 6 ltr.

88310 3,5 ltr.



88303 4 ltr.

88305 3 ltr.

88312 2,5 ltr.



ORBIT

4 tlg.
4 pcs.



12342



12343



12330



12335

Chafing Dish, 4-teiliges Set „ORBIT“

chafing dish set, 4 pcs.
chafing dish, set de 4
chafing dish, set de 4



- 1 Topf (8 Liter)
- 1 Speisenbehälter (4 Liter)
- 1 Deckel mit Sichtfenster und 1 Deckelbremse
- Topf mit induktionsfähigem Sandwich- / Kapselboden
- 1 pot (8 litres)
- 1 foodpan (4 litres)
- 1 lid with glass insert and 1 automatic lid brake
- pot with induction-compatible sandwich base
- 1 olla (8 litros)
- 1 cubeta (4 litros)
- 1 tapa con ventanilla y 1 sistema de freno en la tapa
- olla con base sandwich apta para inducción
- 1 casserole (8 litres)
- 1 bac (4 litres)
- 1 couvercle avec fenêtre et 1 système de frein dans le couvercle
- casserole avec fond sandwich pour induction

	Ø cm	↑ cm	ltr.	Farbe / Colour	€
12342 <small>new</small>	30,5	17,5	4	vintage-look	314,00
12343 <small>new</small>	30,5	17,5	4	gold	314,00
12330	30,5	17,5	4	stainless steel	260,00
12335	30,5	17,5	4	copper	314,00

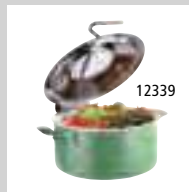

12339



abnehmbarer Deckel
removable lid

induktionsgeeignet
suitable for induction

induktionsgeeignet
suitable for induction

Ersatz-Speisenbehälter zu Chafing Dish / replacement foodpan for chafing dish / cubeta interior de repuesto para chafing dish / bac intérieur de remplacement pour le chafing dish

	Ø cm	↑ cm	ltr.	fits to	€
12329	30,5	8	4	12330, 12335, 12336, 12337, 12338, 12339, 12342, 12343	30,00



Ø 33 cm

8 ltr. Topf
8 ltr. pot



12329

Ø 30,5 cm

4 ltr. Speisenbehälter
4 ltr. foodpan

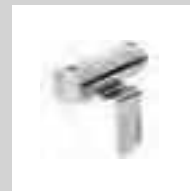

Deckelbremse
automatic lid break



Sandwich- / Kapsel-
boden / sandwich base

4 tlg.
4 pcs.



12336



12337



12338



12339

Chafing Dish, 4-teiliges Set „ORBIT“

chafing dish set, 4 pcs.
chafing dish, set de 4
chafing dish, set de 4



- 1 Topf (8 Liter)
- 1 Speisenbehälter (4 Liter)
- 1 Deckel mit Sichtfenster und 1 Deckelbremse
- Topf mit induktionsfähigem Sandwich- / Kapselboden
- 1 pot (8 litres)
- 1 foodpan (4 litres)
- 1 lid with glass insert and 1 automatic lid brake
- pot with induction-compatible sandwich base
- 1 olla (8 litros)
- 1 cubeta (4 litros)
- 1 tapa con ventanilla y 1 sistema de freno en la tapa
- olla con base sandwich apta para inducción
- 1 casserole (8 litres)
- 1 bac (4 litres)
- 1 couvercle avec fenêtre et 1 système de frein dans le couvercle
- casserole avec fond sandwich pour induction

	Ø cm	↑ cm	ltr.	Farbe / Colour	€
12336	30,5	17,5	4	yellow	314,00
12337	30,5	17,5	4	red	314,00
12338	30,5	17,5	4	black	314,00
12339	30,5	17,5	4	green	314,00

Ersatz-Speisenbehälter zu Chafing Dish / replacement foodpan for chafing dish / cubeta interior de repuesto para chafing dish / bac intérieur de remplacement pour le chafing dish

	Ø cm	↑ cm	ltr.	fits to	€
12329	30,5	8	4	12330, 12335, 12336, 12337, 12338, 12339, 12342, 12343	30,00



8 ltr. Topf
8 ltr. pot



4 ltr. Speisenbehälter
4 ltr. foodpan



Deckelbremse
automatic lid break



Sandwich- / Kapselboden / sandwich base

Porzellaneinsatz „ORBIT“

porcelain insert
bandeja de porcelana
bac en porcelaine



	Ø cm	↑ cm	ltr.	fits to	€
82212 <small>NEW</small>	29,5	9	2,8	12330, 12335, 12336, 12337, 12338, 12339, 12342, 12343	62,00
82211	29,5	9	3,0	12330, 12335, 12336, 12337, 12338, 12339, 12342, 12343	56,00



passend zur Serie „ORBIT“
suitable for the „ORBIT“ series

82212 2 x 1,4 ltr.



82211 3 ltr.



NEW BONFIRE

Die Induktionsstation „Bonfire“ besticht durch ihr ausgefallenes Design: Holzscheite aus schwarzem Eschenholz und ein runder Aufbau aus schwarz-mattem Metall erinnern an ein stilisiertes Lagerfeuer. Ein Hingucker für das besondere Buffet.

The 'Bonfire' induction station impresses with its modern design: logs made of black ash wood and a round structure made of black matt metal are reminiscent of a stylised campfire. An elegant eye-catcher for professional buffet set-ups.

La estación de inducción «Bonfire» impresiona por su diseño moderno: los troncos de madera de fresno negro y la estructura redonda de metal negro mate recuerdan a una estilizada hoguera. Un elegante punto de atracción para el buffet profesional.

La station à induction « Bonfire » séduit par son design moderne: des bûches en bois de frêne noir et une structure ronde en métal noir mat rappellent un feu de camp stylisé. Un accroche-regard élégant pour un buffet professionnel.



Induktionsstation „BONFIRE“

induction station
estación de inducción
station à induction



Induktionskochplatte Ø 24 cm, 900 Watt, inklusive Kabelfernbedienung,
induction hotplate Ø 24 cm, 900 watts, cable remote control,

power adjustable in steps, black ash wood and metal stand

placa de inducción Ø 24 cm, 900 vatios, incluye mando a distancia por cable, potencia regulable en pasos, soporte de madera de fresno negro y metal negro

plaque de cuisson à induction Ø 24 cm, 900 watts, télécommande filaire incluse, puissance réglable par paliers, support en bois de frêne noir et métal noir

	Ø cm	↑ cm		€
12250	46,5	16	900 W	210,00



passend zur Serie „ORBIT“
suitable for the „ORBIT“ series

Kochplatte Ø 24 cm
induction station Ø 24 cm

4 tlg.
4 pcs.



12276



12272



12295

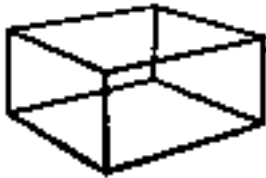

15506

Induktionsstation, 4-tlg. Set „VALO“

induction station, 4 pcs.
estación de inducción, set de 4
station d'induction, set de 4



4 teiliges Set:

- 1 Induktionskochplatte mit Regler (Ø 24 cm, 900 Watt)
- 1 Metallständer schwarz
- 1 Rahmen aus Eiche (wasserfest lackiert)
- 1 Edelstahlrahmen

4 pcs. set:

- 1 induction hotplate with controller (Ø 24 cm, 900 watt)
- 1 metal stand black
- 1 frame made of oak (water-resistant coated)
- 1 stainless steel frame

set de 4:

- 1 placa de inducción con regulador (Ø 24 cm, 900 vatios)
- 1 soporte de metal negro
- 1 caja de roble (con recubrimiento resistente al agua)
- 1 marco de acero inoxidable

set de 4:

- 1 plaque d'induction avec température réglable (Ø 24 cm, 900 watts)
- 1 support métallique noir
- 1 cadre en chêne (verni résistant à l'eau)
- 1 cadre en acier inox

	cm	↑ cm	€
12275	35,4 x 32,5	19	224,00



passendes Chafing Dish Set 12339
suitable chafing dish set 12339

Ersatzteile / replacement parts / piezas de repuesto / pièces de rechange

	cm	↑ cm		€
12276	35,4 x 32,5	8,5	Holzrahmen / wooden frame	72,00
12272	29,5 x 26,5	1	Edelstahlrahmen / stainless steel frame	22,00
12295	Ø 24	-	900 Watt Induktionskochplatte / induction plate	139,00
15506	35,4 x 32,5	17,6	Buffetständer schwarz / buffet stand black	22,80

Induktionsstation, 2-tlg. Set „VALO“

Induction station, 2-piece set
Estación de inducción, juego de 2 piezas
Station à induction, set de 2 pièces



Set, bestehend aus Induktionkochplatte 2000 Watt, inklusive Kabel-Fernbedienung, Leistung in Stufen regelbar, Rahmen aus Eichenholz (wasserfest lackiert)

set consists of induction hotplate 2000 Watt, cable remote control, power adjustable in steps, frame made of oak (waterproof lacquered)

set, compuesto por placa de inducción 2000 Watt, incluye mando a distancia por cable, potencia regulable en pasos, madera de roble (lacado impermeable)

set, composé d'une plaque de cuisson à induction 2000 watts, télécommande filaire incluse, puissance réglable par paliers, bois de chêne (verniss imperméable)

	cm	↑ cm		€
14050	39 x 39	10	2000 W	280,00

NAPKIN HOLDERS

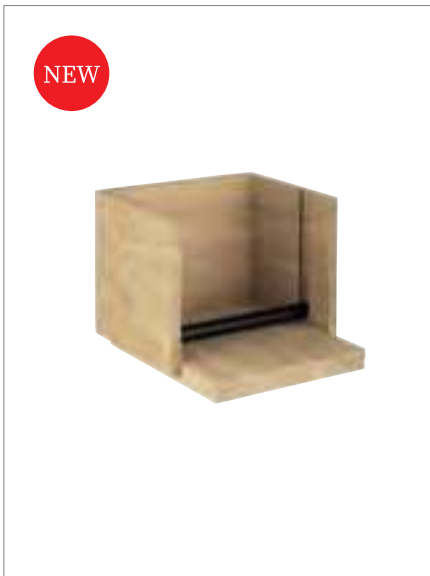

Serviettenhalter „VALO“

napkin holder
servilletero
porte-serviettes



Eichenholz (geölt), für ca. 100 Servietten mit 1/4 Falz, inklusive Beschwerer

oak wood (oiled), for approx. 100 napkins with 1/4 fold, including weight
madera de roble (aceitada), para aprox. 100 servilletas con 1/4 de pliegue, con barra de contrapeso
bois du chêne (huilé), pour env. 100 serviettes pliées en 1/4, avec barre de contrepoids

	cm	↑ cm	€
14092	19 x 19	16	59,00



stapelbar
stackable



Table Caddy „VALO“

table caddy
caddy de mesa
caddy de table



Eichenholz (geölt), 3 Fächer, mit Antirutsch-Füßchen

oak wood (oiled), 3 compartments, with non-slip feet
madera de roble (aceitada), 3 compartimentos, con pies antideslizantes
bois de chêne (huilé), 3 compartiments, avec pieds antidérapants

	cm	↑ cm	€
14090	15 x 15	28	66,00



Table Caddy „VALO“

table caddy
caddy de mesa
caddy de table



Eichenholz (geölt), 3 Fächer, mit Antirutsch-Füßchen

oak wood (oiled), 3 compartments, with non-slip feet
madera de roble (aceitada), 3 compartimentos, con pies antideslizantes
bois de chêne (huilé), 3 compartiments, avec pieds antidérapants

	cm	↑ cm	€
14091	15 x 15	31	89,00



Serviettenhalter „HERO“

napkin holder
servilletero
porte-serviettes



für ca. 65 Cocktailservietten, inklusive Beschwerer

for approx. 65 cocktail napkins, including weight

para aprox. 65 servilletas cocktail, con barrita de contrapeso

pour environ 65 serviettes cocktail, avec barre de contrepoids

	cm	↑ cm	€
11767	14,5 x 14,5	10	11,00



inklusive Beschwerer
including weight

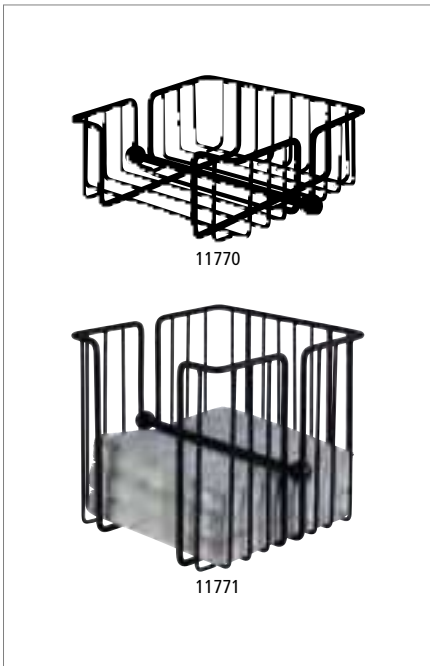

Serviettenhalter „URBAN“

napkin holder
servilletero
porte-serviettes



für ca. 50 Servietten ¼ Falz, inklusive Beschwerer

for approx. 50 napkins ¼ fold, including weight

para aprox. 50 servilletas de plegado ¼, con barrita de contrapeso

pour environ 50 serviettes pliage ¼, avec barre de contrepoids

	cm	↑ cm	€
11770	19 x 19	7,5	11,60

für ca. 120 Servietten ¼ Falz, inklusive Beschwerer

for approx. 120 napkins ¼ fold, including weight

para aprox. 120 servilletas de plegado ¼, con barrita de contrapeso

pour environ 120 serviettes pliage ¼, incl. barrie de contrepoids

	cm	↑ cm	€
11771	19 x 19	18	15,40



inklusive Beschwerer
including weight



Serviettenhalter „WIRE“

napkin holder
servilletero
porte-serviettes



für ca. 50 Cocktailservietten, inklusive Beschwerer

for approx. 50 cocktail napkins, including weight

para aprox. 50 servilletas cocktail, con barrita de contrapeso

pour environ 50 serviettes cocktail, avec barre de contrepoids

	cm	↑ cm	€
11762	14 x 14	6,5	6,90

für 50 Servietten 1/4 Falz, inklusive Beschwerer

for 50 napkins 1/4 fold, including weight

para 50 servilletas plegado 1/4, con barrita de contrapeso

pour 50 serviettes pliage 1/4, avec barre de contrepoids

	cm	↑ cm	€
11763	19 x 19	6,5	7,20

für 150 Servietten 1/4 Falz, inklusive Beschwerer

for 150 napkins 1/4 fold, including weight

para 150 servilletas plegado 1/4, con barrita de contrapeso

pour 150 serviettes pliage 1/4, avec barre de contrepoids

	cm	↑ cm	€
11765	19 x 19	19,0	11,80



inklusive Beschwerer
including weight

NAPKIN HOLDERS



Serviettenhalter „ELEMENT“

napkin holder
servilletero
porte-serviettes

für ca. 50 Servietten, möbelschonende Unterseite
for approx. 50 napkins, furniture-friendly underside
para aprox. 50 servilletas, con base anti rayaduras
pour environ 50 serviettes, avec revêtement antirayures



	cm	↑ cm	€
11781	16 x 7,5	10	10,00



Serviettenhalter

napkin holder
servilletero
porte-serviettes

für ca. 30 Servietten, matt poliert, möbelschonende Unterseite
for approx. 30 napkins, matt polished, furniture-friendly underside
para aprox. 30 servilletas, pulido mate, con base anti rayaduras
pour environ 30 serviettes, poli mat, avec revêtement antirayures



	cm	↑ cm	€
11780	15 x 4,5	12,5	8,00



Serviettenhalter

napkin holder
servilletero
porte-serviettes

für ca. 20 Servietten, matt poliert, möbelschonende Unterseite,
for approx. 20 napkins, matt polished, furniture-friendly underside
para aprox. 20 servilletas, pulido mate, con base anti rayaduras
pour environ 20 serviettes, poli mat, avec revêtement antirayures



	cm	↑ cm	€
11778	17 x 3	7	7,00



Serviettenhalter

napkin holder
servilletero
porte-serviettes

hochglanzpoliert, für Servietten mit 1/8 Falz, Füße mit rutsch- und kratzfester Gummierung
mirror polished, for napkins with 1/8 fold, feet with non-slip and scratch-resistant rubber coating
pulido brillante, para servilletas plegado 1/8, pies con revestimiento de goma antideslizante y anti rayaduras
poli brillante, pour serviettes pliage 1/8, pieds avec caoutchouc antidérapant et antirayures



	cm	↑ cm	€
11720	10 x 11,5	18,5	12,40



Besteckbehälter / Korb „UTENSILO“

cutlery bin / basket
 porta cubiertos / cesta
 range-couverts / corbeille



matt poliert, Boden: 29 x 8,5 cm, mit Kunststoffeinsatz

matt polished, base: 29 x 8,5 cm, with plastic insert
 pulido mate, base: 29 x 8,5 cm, con inserto de plástico
 poli mat, fond: 29 x 8,5 cm, avec insert en plastique

	cm	↑ cm	ltr.	Farbe / Colour	€
11752	29,5 x 12	10	2		11,50



mit Kunststoffeinsatz
 with plastic insert



Präsentationsmöglichkeit
 presentation example



Besteckbehälter / Korb „UTENSILO“

cutlery bin / basket
 porta cubiertos / cesta
 range-couverts / corbeille



Boden: 29 x 8,5 cm, mit Kunststoffeinsatz

base: 29 x 8,5 cm, with plastic insert
 base: 29 x 8,5 cm, con inserto de plástico
 fond: 29 x 8,5 cm, avec insert en plastique

	cm	↑ cm	ltr.	Farbe / Colour	€
11753	29,5 x 12	10	2		13,00



mit Kunststoffeinsatz
 with plastic insert



Präsentationsmöglichkeit
 presentation example



Besteckbehälter / Korb „UTENSILO“

cutlery bin / basket
 porta cubiertos / cesta
 range-couverts / corbeille



Boden: 29 x 8,5 cm, mit Kunststoffeinsatz

base: 29 x 8,5 cm, with plastic insert
 base: 29 x 8,5 cm, con inserto de plástico
 fond: 29 x 8,5 cm, avec insert en plastique

	cm	↑ cm	ltr.	Farbe / Colour	€
11754	29,5 x 12	10	2		13,00



mit Kunststoffeinsatz
 with plastic insert



Präsentationsmöglichkeit
 presentation example

CUTLERY BOXES



Besteckbehälter

cutlery box
recipiente para cubiertos
réceptif pour couverts

Akazienholz, 4 Fächer (26 x 11,5 cm)

acacia wood, 4 compartments (26 x 11,5 cm)
madera de acacia, 4 compartimentos (26 x 11,5 cm)
bois d'acacia, 4 compartiments (26 x 11,5 cm)



	cm	↑ cm	Farbe / Colour		€
11952	51 x 28	13		nature	53,00
11951	51 x 28	13		vintage white	53,00



Besteckbehälter mit Deckel

cutlery box with cover
caja de cubiertos con tapa
range-couverts avec couvercle

Akazienholz, 4 Fächer (26 x 11,5 cm), mit Deckel

acacia wood, 4 compartments (26 x 11,5 cm), with cover
madera de acacia, 4 compartimentos (26 x 11,5 cm), con tapa
bois d'acacia, 4 compartiments (26 x 11,5 cm), avec couvercle



	cm	↑ cm	Farbe / Colour		€
11949	51 x 28	14,5		nature	78,00
11948	51 x 28	14,5		vintage white	78,00

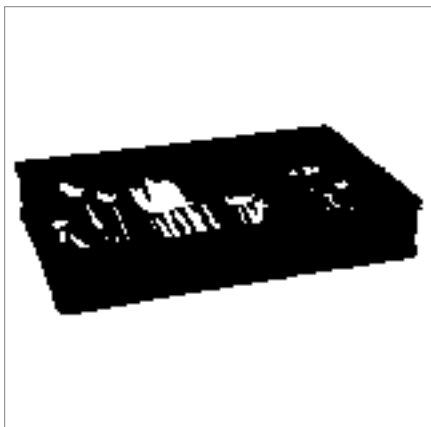

GN 1/1 Besteckbehälter

GN 1/1 dispenser GN
GN 1/1 dispensador de cubiertos
GN 1/1 bac à couverts

in Handarbeit geflochten, 4 Mulden, Kunststoff-Geflecht, Drahtgestell, braun-schwarz

hand-woven, 4 troughs, plastic wickerwork, wire frame, brown-black
cesta trensada a mano, 4 compartimentos, mimbre de plástico, marco de alambre, marrón-negro
corbeille tressée à main, 4 compartiments, plastique tressé, armature en fil métallique, brun-noir



	cm	↑ cm	Farbe / Colour	GN	€
11966	53 x 32,5	9		1/1	43,00



GN 1/1 Besteckbehälter

GN 1/1 cutlery dispenser
GN 1/1 dispensador de cubiertos
GN 1/1 bac à couverts

4 Mulden, Kunststoff-Geflecht, Drahtgestell, beige

4 troughs, plastic wickerwork, wire frame, beige
4 compartimentos, mimbre de plástico, marco de alambre, beige
4 compartiments, plastique tressé, structure métallique, beige



	cm	↑ cm	Farbe / Colour	GN	€
11965	53 x 32,5	10		1/1	30,00

**Besteckbehälter**

cutlery basket
recipiente para cubiertos
récipients pour couverts

4 Löcher inklusive 4 Edelstahl Köcher

4 holes including 4 stainless baskets

4 agujeros con 4 cestas de acero inoxidable

4 trous avec 4 corbeilles en acier inox



	cm	↑ cm	€
93321	27 x 27	15	84,00

**Besteckköcher**

cutlery basket
cesta para cubiertos
corbeille à couverts

matt poliert / matt polished / pulido mate / poli mat



	Ø cm	↑ cm	€
11999	9,5	13,5	8,00

**Besteckköcher**

cutlery basket
cesta para cubiertos
corbeille à couverts



	Ø cm	↑ cm	€
11998	9,5	13,5	2,90

**Besteckkasten „INDUSTRIAL“**

cutlery box
caja para cubiertos
boîte pour couverts



	cm	↑ cm	ltr.	€
40676	23,0 x 15,5	13,0	2,4	15,20

CUTLERY BOXES



Deckel für Besteckbehälter
 lid for cutlery container
 tapa para recipiente de cubiertos
 couvercle pour bac à couverts



passend für Besteckbehälter
 suitable for cutlery containers
 para recipiente de cubiertos
 pour bacs à couverts

	cm	↑ cm	fits to	€
11964	53 x 32,5	4	11954, 11955, 11960	6,30

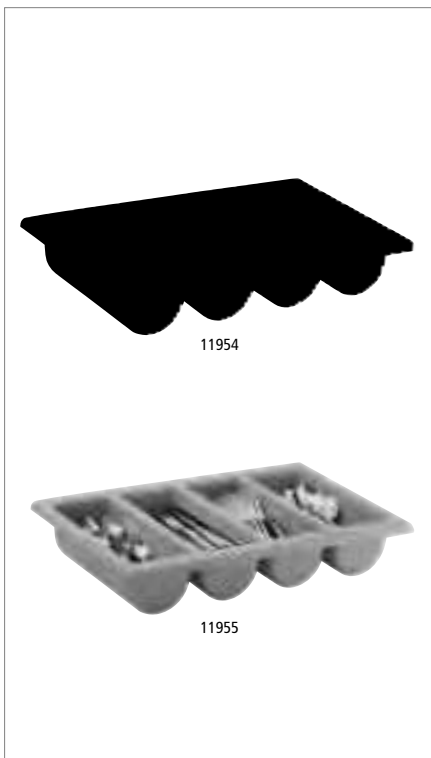
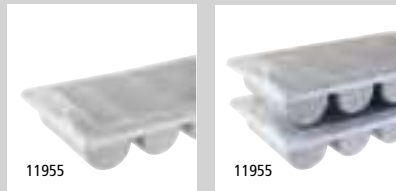

GN 1/1 Besteckbehälter

GN 1/1 cutlery bin
 GN 1/1 recipiente para cubiertos
 GN 1/1 récipients pour couverts



4 Mulden
 4 troughs
 4 compartimentos
 4 compartiments

	cm	↑ cm	Farbe / Colour	GN	€
11954	53 x 32,5	10		1/1	7,50
11955	53 x 32,5	10		1/1	7,50



GN 1/1 Besteckbehälter

GN 1/1 cutlery bin
 GN 1/1 recipiente para cubiertos
 GN 1/1 récipients pour couverts



3 Mulden, 3 Köcher
 3 troughs, 3 cutlery baskets
 3 compartimentos, 3 cestas para cubiertos
 3 compartiments, 3 corbeilles à couverts

	cm	↑ cm	Farbe / Colour	GN	€
11960	53 x 32,5	10		1/1	7,50



11946



11947

Servier- / Transportwagen „READY“

serving trolley
carro de servicio
chariot de service



Aluminiumrahmen, 3 Böden, Abstand zwischen den Böden 31 cm, mit 4 Lenkrollen, alle mit Feststellern, Tragfähigkeit: 50 kg je Boden, 150 kg insgesamt, demontiert, einfache Montage (Lieferung ohne Container und Dekoration)

frame aluminium, 3 shelves, distance between shelves 31 cm, 4 swivel wheels, all equipped with brakes, max. load per shelf 50 kg, 150 kg total, demounted, easy to mount (delivery without containers and decoration)

marco de aluminio, 3 pisos, distancia entre cada piso 31 cm, 4 ruedas giratorias, todas con freno, capacidad de carga: 50 kg por piso, 150 kg en total, desmontado, montaje sencillo (se entrega sin recipiente ni decoración)

cadre en aluminium, 3 étages, distance entre les niveaux 31 cm, 4 roues pivotantes, toutes avec freins, capacité de charge: 50 kg par niveau, 150 kg au total, livré démonté, montage facile (livré sans récipients ni décoration)

	cm	↑ cm	Farbe / Colour		€
11944 <small>NEW</small>	108 x 50	96		black	150,00
11945	108 x 50	96		blue-grey	150,00

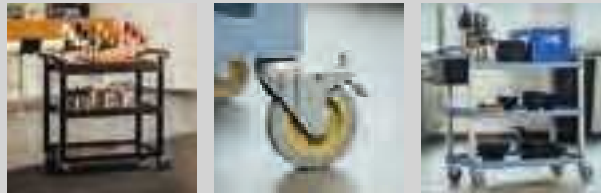

Container zum Einhängen, passend zu no. 11944 & 11945

container to hang up, suitable for no. 11944 & 11945
recipiente para colgar, adecuado para no. 11944 & 11945
récipient à suspendre, convient aux no. 11944 & 11945



	cm	↑ cm	ltr.	Farbe / Colour		€
11946	33 x 23	56,5	42		black	35,00
11947	33 x 23	17,5	13		black	18,00

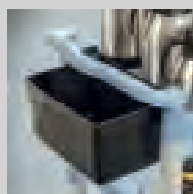

BUFFET STANDS

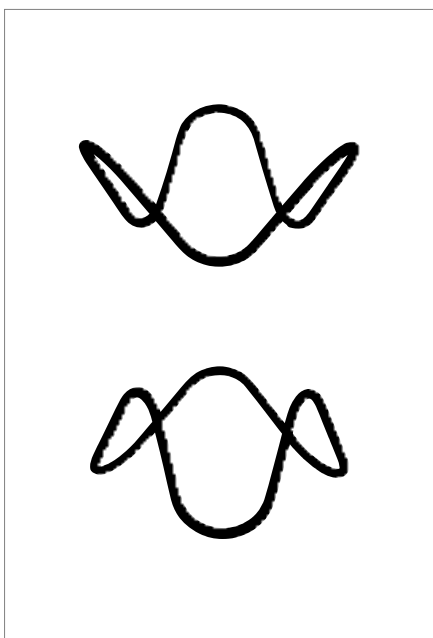

Buffetständer „WAVE“

buffet stand
 sorte de buffet
 support de buffet
 mit Antirutschbeschichtung
 with non-slip coating
 con revestimiento antideslizante
 avec revêtement antidérapant



	Ø cm	↑ cm	€
33306	20	9,5	10,40



Präsentationsmöglichkeit
 presentation example

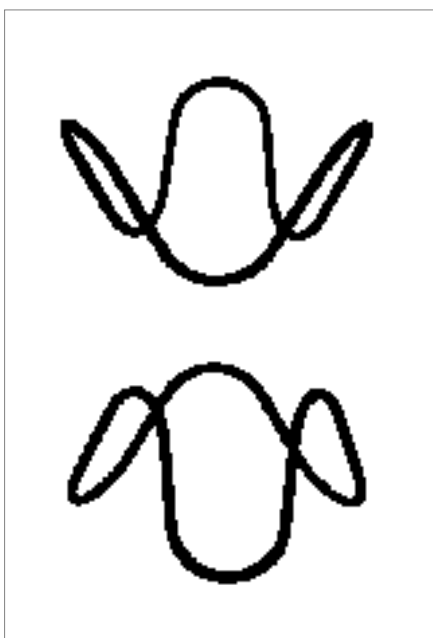

Buffetständer „WAVE“

buffet stand
 sorte de buffet
 support de buffet
 mit Antirutschbeschichtung
 with non-slip coating
 con revestimiento antideslizante
 avec revêtement antidérapant



	Ø cm	↑ cm	€
33307	24	13	12,50



Präsentationsmöglichkeit
 presentation example

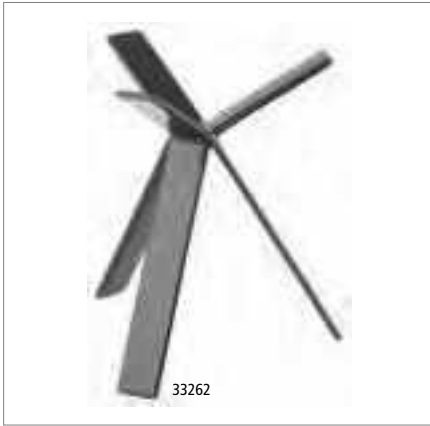

Buffetständer „STAR“

buffet stand
soporte para buffet
présentoire buffet



Metall, mit schwarzer Antirutschbeschichtung
metal, with black anti-slide coating
metal, con revestimiento antideslizante negro
métal, avec revêtement antidérapant noir

	↑ cm	€
33260	8	14,80
33261	12	17,50
33262	18	20,00

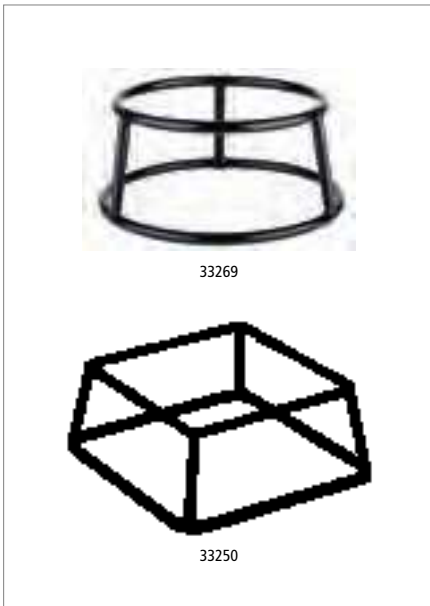

Buffetständer „MULTI“

buffet stand
soporte para buffet
présentoir buffet



Metall, mit schwarzer Antirutschbeschichtung
metal, with black anti-slide coating
metal, con revestimiento antideslizante negro
métal, avec revêtement antidérapant noir

	Ø cm	↑ cm	€
33269	15,5 / 18	8	10,90
33270	15,5 / 18	10	13,00
33271	15,5 / 18	18	16,70

	cm	↑ cm	€
33249	18 x 18	5	9,60
33250	18 x 18	8	13,20
33251	18 x 18	10	16,00
33252	18 x 18	20	18,90



Buffetständer „PRISMA“

buffet stand
soporte para buffet
présentoir buffet



Metall, mit schwarzer Antirutschbeschichtung
metal, with black anti-slide coating
metal, con revestimiento antideslizante negro
métal, avec revêtement antidérapant noir

	Ø cm	↑ cm	€
33272	20	10,5	10,20
33273	20	20,0	14,50



Buffetständer „KING“

buffet stand
soporte para buffet
présentoir buffet



kein Verrutschen, Arme und Boden sind mit Antirutschflächen ausgestattet, schwere standsichere Qualität, Fuß dient als Löffelablage

the arms and base are equipped with non-slip surfaces, stable quality, base serves as spoon holder

revestimiento antideslizante en las puntas de los brazos y en la base, estable y alta calidad, la base sirve como reposacuchara

revêtement antidérapant sur les extrémités des 3 pieds et sur la base, robuste, stable et bonne qualité, la base sert de support pour les couverts

	Ø cm	↑ cm	€
03622	15	14	44,00
03623	15	21	48,00

BUFFET STANDS

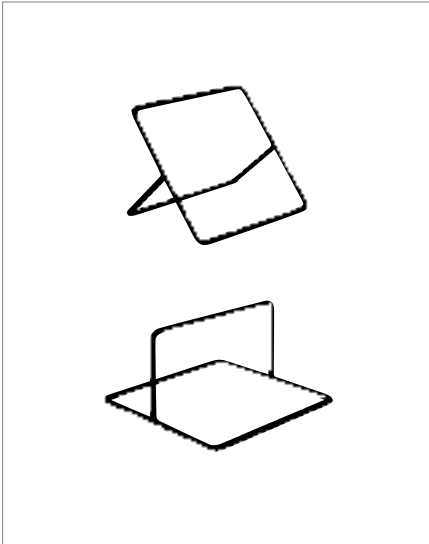

Buffetständer „SQUARE“

buffet stand
soporte para buffet
présentoir buffet

Metall, mit schwarzer Antirutschbeschichtung

metal, with black anti-slide coating
metal, con revestimiento antideslizante negro
métal, avec revêtement antidérapant noir



	cm	↑ cm		€
33305	12 x 12	7		6,50

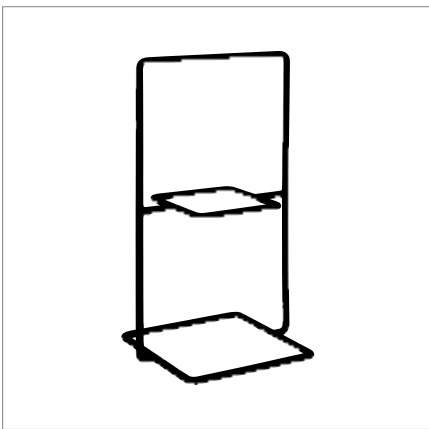

Buffetständer „PERFECTO“

buffet stand
soporte para buffet
présentoir buffet

Metall, mit schwarzer Antirutschbeschichtung

metal, with black anti-slide coating
metal, con revestimiento antideslizante negro
métal, avec revêtement antidérapant noir



	cm	↑ cm	fits to	€
33304	19 x 23	40,5	33302, 33303	25,00

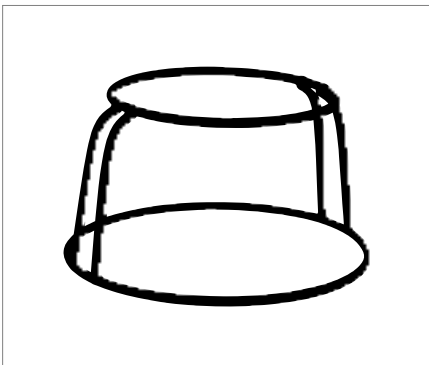

Buffetständer „FRIDA“

buffet stand
soporte para buffet
présentoir buffet

Metall, mit schwarzer Antirutschbeschichtung

metal, with black anti-slide coating
metal, con revestimiento antideslizante negro
métal, avec revêtement antidérapant noir



	Ø cm	↑ cm	fits to	€
33282	23 / 30,5	16	85230, 85231	40,00

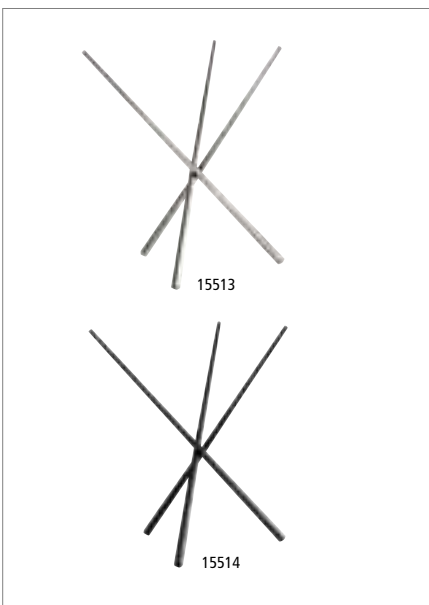

Buffetständer „ASIA PLUS“

buffet stand
soporte para buffet
présentoir buffet



	Ø cm	↑ cm	Farbe / Colour	€
15513	20,5 / 16,5	20		16,80
15514	20,5 / 16,5	20		15,60



Präsentationsmöglichkeit
presentation example

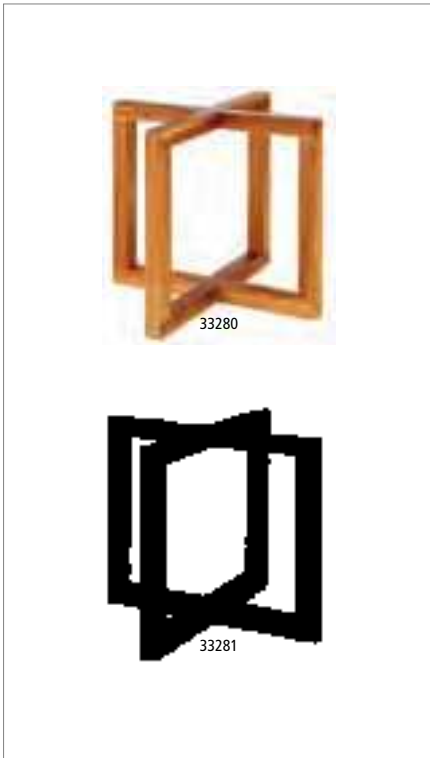

Buffetständer „WOOD“

buffet stand
soporte para buffet
présentoire buffet



Akazienholz, liegend oder stehend, variable Nutzungsmöglichkeiten

acacia wood, usable by lying or standing, variable usage possibilities
madera de acacia, se puede usar tumbado o de pie, opciones de uso variable
bois d'acacia, possibilités d'utilisation variables

	cm	↑ cm	Farbe / Colour	€
33280	20 x 20	17,5		12,40
33281	20 x 20	17,5		12,40



liegend oder stehend, variable Nutzungsmöglichkeiten
vertically or horizontally, variable usage possibilities



Buffetständer

buffet stand
expositor de buffet
présentoir buffet



Akazienholz
acacia wood
madera de acacia
bois d'acacia

	Ø cm	↑ cm	€
33255	15	10	18,00
33256	25	15	22,00



Präsentationsmöglichkeit
presentation example

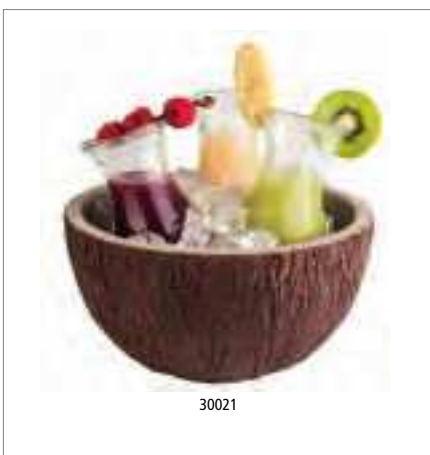

Schale „COCONUT“

bowl
cuenco
bol



	Ø cm	↑ cm	ltr.	€
30020	18	9,5	1,0	22,80
30021	23	12,5	2,2	30,00



möbelschonende Unterseite
furniture-friendly underside

MANGO



Schale
bowl
cuenco
bol



Mangoholz, Epoxidharz, Motiv (innen): starry sky
mango wood, epoxy resin, design (inside): starry sky
madera de mango, resina epoxi, diseño (interior): starry sky
bois de manguiier, résine époxy, design (intérieur): starry sky

	Ø cm	↑ cm	ltr.	€
01050	20	7,5	0,8	19,00
01053	24	7,5	1,1	22,00
01056	30	10,5	3,0	32,00
01057	37	9,0	4,0	32,00



handgefertigt
handmade

**Tablett / Teller**

tray / plate
bandeja / plato
plateau / assiette



Mangoholz, Epoxidharz, Motiv (innen): starry sky

mango wood, epoxy resin, design (inside): starry sky

madera de mango, resina epoxi, diseño (interior): starry sky

bois de manguier, résine époxy, design (intérieur): starry sky

	Ø cm	↑ cm	€
01058	35,5	2,5	30,00

**Schale**

bowl
cuenco
bol



Mangoholz, Epoxidharz, Motiv (innen): weiß+blau

mango wood, epoxy resin, design (inside): white+blue

madera de mango, resina epoxi, diseño (interior): blanco+azul

bois de manguier, résine époxy, design (intérieur): blanc+bleu

	Ø cm	↑ cm	ltr.	€
01051	24	7,5	1,1	22,00
01054	30	10,5	3,0	32,00



handgefertigt
handmade



ELEMENT



Schale, 3er Set „ELEMENT“

bowl, 3 pcs.
cuenco, set de 3
bol, set de 3



	Ø cm	↑ cm	ltr.	pcs.	€/ set
30003	10	4,5	0,05	3	9,60



möbelschonende Unterseite
furniture-friendly underside



Schale „ELEMENT“

bowl
cuenco
bol



	Ø cm	↑ cm	ltr.	€
30000	22,0	6,0 / 10,5	1,1	22,00
30001	26,0	7,5 / 13,0	1,7	28,00
30002	29,5	8,5 / 14,5	2,5	33,00

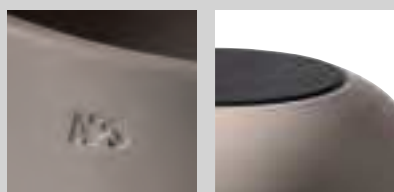

möbelschonende Unterseite
furniture-friendly underside



Flaschenkühler „ELEMENT“

bottle cooler
enfriador de botella
rafraîchisseur de bouteille

möbelschonende Unterseite
furniture-friendly underside
con base anti rayaduras
avec revêtement antirayures



	Ø cm	↑ cm	€
36131	12 / 10	19	20,00



Flaschenkühler „ELEMENT“

bottle cooler
enfriador de botella
rafraîchisseur de bouteille

möbelschonende Unterseite
furniture-friendly underside
con base anti rayaduras
avec revêtement antirayures



	Ø cm	↑ cm	€
36090	12 / 10	19	20,00



Besteckbehälter „ELEMENT“

cutlery bin
porta cubiertos
range-couverts

3 Fächer, Silikoneinlage zum Schonen des Bestecks, möbelschonende Unterseite
3 compartments, silicone inlay to protect the cutlery, furniture-friendly underside
3 compartimentos, inserto de silicona para proteger cubiertos, base apta para muebles
3 compartiments, insert en silicone pour ménager les couverts, dessous protégeant le meuble



	cm	↑ cm	€
11750	13 x 13	14,5	18,00



Serviettenhalter „ELEMENT“

napkin holder
servilletero
porte-serviettes

für ca. 50 Servietten, möbelschonende Unterseite
for approx. 50 napkins, furniture-friendly underside
para aprox. 50 servilletas, con base anti rayaduras
pour environ 50 serviettes, avec revêtement antirayures



	cm	↑ cm	€
11781	16 x 7,5	10	10,00

CEREAL DISPENSERS



4,5 ltr.

Cerealienspender „FRESH & EASY“

cereal dispenser
dispensador de cereales
distributeur de céréales



Behälter herausnehmbar, „Feierabend-Deckel“ für das aromadichte Lagern, Portionieren durch einfaches Drehen

removable canister, special lid to keep the cereals fresh, easy to use, rotate the button to get the muesli

contenedor extraíble, tapa especial para mantener los cereales frescos, fácil de usar, se gira el pomo para servir los cereales

réceptacle amovible, couvercle spécial pour conserver les céréales, usage facile en tournant le bouton

	cm	↑ cm	ltr.	€
11840	22 x 17,5	52	4,5	90,00



2 x 4,5 ltr.

Cerealienspender Duo „FRESH & EASY“

cereal dispenser
dispensador de cereales
distributeur de céréales



Behälter herausnehmbar, „Feierabend-Deckel“ für das aromadichte Lagern, Portionieren durch einfaches Drehen

removable canister, special lid to keep the cereals fresh, easy to use, rotate the button to get the muesli

contenedor extraíble, tapa especial para mantener los cereales frescos, fácil de usar, se gira el pomo para servir los cereales

réceptacle amovible, couvercle spécial pour conserver les céréales, usage facile en tournant le bouton

	cm	↑ cm	ltr.	€
11841	22 x 35	52	2 x 4,5	162,00



4,5 ltr.

Cerealienspender „FRESH & EASY“

cereal dispenser
dispensador de cereales
distributeur de céréales



Behälter herausnehmbar, „Feierabend-Deckel“ für das aromadichte Lagern, Portionieren durch einfaches Drehen

removable canister, special lid to keep the cereals fresh, easy to use, rotate the button to get the muesli
contenedor extraíble, tapa especial para mantener los cereales frescos, fácil de usar, se gira el pomo para servir los cereales
récipient amovible, couvercle spécial pour conserver les céréales, usage facile en tournant le bouton

	cm	↑ cm	ltr.	€
11805	22 x 17,5	52	4,5	90,00



2 x 4,5 ltr.

Cerealienspender Duo „FRESH & EASY“

cereal dispenser
dispensador de cereales
distributeur de céréales



Behälter herausnehmbar, „Feierabend-Deckel“ für das aromadichte Lagern, Portionieren durch einfaches Drehen

removable canister, special lid to keep the cereals fresh, easy to use, rotate the button to get the muesli
contenedor extraíble, tapa especial para mantener los cereales frescos, fácil de usar, se gira el pomo para servir los cereales
récipient amovible, couvercle spécial pour conserver les céréales, usage facile en tournant le bouton

	cm	↑ cm	ltr.	€
11807	22 x 35	52	2 x 4,5	162,00



Cerealienspender „ROTATION“

cereal dispenser
dispensador de cereales
distributeur de céréales



matt poliert, drehbarer massiver Ständer, Behälter herausnehmbar, inklusive Frischhaltedeckel

matt polished, rotating food, canister removable, including airtight covers
pulido mate, giratorio, incluye tapas herméticas
poli mat, rotatif, inclut couvercles hermétiques

	Ø cm	↑ cm	ltr.	€
11970	38	54	3 x 4,5	320,00



Cerealienspender „ROTATION“

cereal dispenser
dispensador de cereales
distributeur de céréales



Buchenholz versiegelt, drehbarer massiver Ständer, Behälter herausnehmbar, inklusive Frischhaltedeckel

wood beech covered waterproof, rotating foot, canister removable, incl. airtight cover
tapa en madera de haya resistente al agua, pie giratorio, recipiente extraíble, incluye tapa hermética
couvercle en hêtre traitée contre l'humidité, pied rotatif, récipients démontables, inclut couvercles hermétiques

	Ø cm	↑ cm	ltr.	€
11975	38	54	3 x 4,5	324,00

CEREAL DISPENSERS



Cerealienspender „BRIDGE“

cereal dispenser
dispensador de cereales
distributeur de céréales



Behälter herausnehmbar, „Feierabend-Deckel“ für das aromadichte Lagern, Portionieren durch einfaches Drehen

removable canister, special lid to keep the cereals fresh,
easy to use, rotate the button to get the muesli
contenedor extraíble, tapa especial para mantener los cereales frescos,
fácil de usar, se gira el pomo para servir los cereales
récipient amovible, couvercle spécial pour conserver les céréales,
usage facile en tournant le bouton

	cm	↑ cm	ltr.	Farbe / Colour	€
13987	21 x 20	55,5	4,5	Ahorn / maple	114,00



Cerealienspender „BRIDGE“

cereal dispenser
dispensador de cereales
distributeur de céréales



Behälter herausnehmbar, „Feierabend-Deckel“ für das aromadichte Lagern, Portionieren durch einfaches Drehen

removable canister, special lid to keep the cereals fresh,
easy to use, rotate the button to get the muesli
contenedor extraíble, tapa especial para mantener los cereales frescos,
fácil de usar, se gira el pomo para servir los cereales
récipient amovible, couvercle spécial pour conserver les céréales,
usage facile en tournant le bouton

	cm	↑ cm	ltr.	Farbe / Colour	€
14987	21 x 20	55,5	4,5	Buche / beech	114,00



Buffetständer „GOOD MORNING“

buffet stand
expositor de buffet
présentoir de buffet



4-teiliges Set: 1 Holzständer inklusive 3 Gläser mit luftdichtem Klappdeckel

4 pcs.: 1 wood stand including 3 glasses with airtight cover

set de 4: 1 soporte con 3 cuencos de cristal con cierre hermético

set de 4: 1 présentoir avec 3 bols en verre avec fermeture hermétique

	cm	Farbe / Colour	€
13965	43 x 17	Ahorn / maple	105,00
14965	43 x 17	Buche / beech	105,00

Glas mit luftdichtem Klappdeckel

glass with airtight cover
cristal, cierre hermético
verre, fermeture hermétique

	cm	↑ cm	ltr.	€
82328	12 x 12	22	2	9,00



5 tlg.
5 pcs.

11971

Cerealien-Bar

cereal-bar
barra para dispensador de cereales
bar à céréales



5-teiliges Set: mit Ständerhöhe 4 oder 8 cm: 1 Ständer aus Acryl gefrostet und rutschfest + 2 Karaffen mit schwenkbarem Edelstahl-Deckel + 2 luftdichte Frischhaltedeckel

5 pcs.: with stand heights 4 or 8 cm: 1 stand acryl frosted and non-slip + 2 pitchers with stainless steel flap lid + 2 airtight covers

set de 5: stands a diferentes alturas, 4 u 8 cm: 1 stand acryl + 2 jarras con tapa de solapa de acero inoxidable + 2 tapas herméticas adicionales

set de 5: supports à différentes hauteurs: 4 ou 8 cm - 1 support acrylique satiné antidérapant + 2 pichets à céréales avec couvercle à charnière inox + 2 couvercles hermétiques

	cm	↑ cm	ltr.	€
11971	26 x 17	28,5	2 x 1,5	76,00



7 tlg.
7 pcs.

11973

Cerealien-Bar

cereal-bar
barra para dispensador de cereales
bar à céréales



7-teiliges Set: mit Ständerhöhe 4 oder 8 cm: 1 Ständer aus Acryl gefrostet und rutschfest + 3 Karaffen mit schwenkbarem Edelstahl-Deckel + 3 luftdichte Frischhaltedeckel

7 pcs.: with stand heights 4 or 8 cm: 1 stand acryl frosted and non-slip + 3 pitchers with stainless steel flap lid + 3 airtight covers

set de 7: con stands a diferentes alturas, 4 u 8 cm: 1 stand acryl + 3 jarras con tapa de solapa de acero inoxidable + 3 tapas herméticas adicionales

set de 7: supports à différentes hauteurs: 4 ou 8 cm - 1 support acrylique satiné antidérapant + 3 pichets à céréales avec couvercle à charnière inox + 3 couvercles hermétiques

	cm	↑ cm	ltr.	€
11973	38 x 17	28,5	3 x 1,5	108,00



Cerealienkaraffe

cereal pitcher
jarra de cereales
pichet à céréales



schwenkbarer Edelstahldeckel, inklusive luftdichtem Frischhaltedeckel

stainless steel flap lid, inclusive 1 airtight cover inclusive

tapa giratoria de acero inoxidable con tapa hermética para mantener los alimentos frescos

couvercle pivotant en acier inox avec couvercle hermétique pour conserver les aliments

	Ø cm	↑ cm	ltr.	€
10778	10	28	1,5	27,00

Frischhaltedeckel / conservation lid / tapa de conservación / couvercle de conservation

10668				3,00
-------	--	--	--	------

BUFFET LADDER GN



Buffetleiter „LITTLE GN 1/3“

buffet ladder
dispensador en escalera
présentoir buffet en escalier

4-teilig: 1 Leiter-Gestell, 3 GN 1/3 Rahmen

4 pcs.: 1 ladder, 3 single rings GN 1/3

set de 4: 1 soporte escalera, 3 aros sencillos GN 1/3

set de 4: 1 support escalier, 3 cercles simples GN 1/3



	cm	↑ cm	fits to	€
11526	31,5 x 32	48	baskets / pans GN 1/3	78,00



Buffetleiter „LITTLE GN 1/2“

buffet ladder
dispensador en escalera
présentoir buffet en escalier

4-teilig: 1 Leiter-Gestell, 3 GN 1/2 Rahmen

4 pcs.: 1 ladder, 3 single rings GN 1/2

set de 4: 1 soporte escalera, 3 aros sencillos GN 1/2

set de 4: 1 support escalier, 3 cercles simples GN 1/2



	cm	↑ cm	fits to	€
11527	31,5 x 41,5	48	baskets / pans GN 1/2	98,00

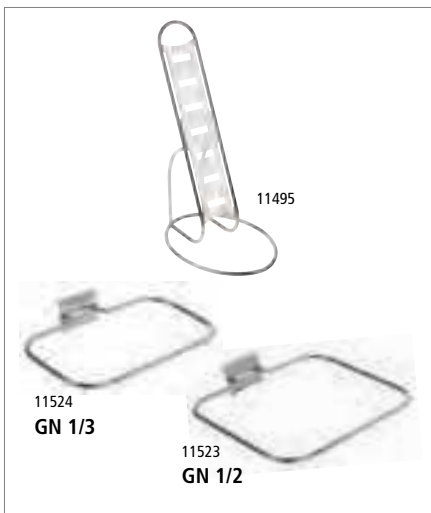

Einzelteile / spare parts / piezas sueltas / pièces détachées

Leitergestell / frame / marco de escalera / échelle support

11495	40,00
-------	-------

Einzelring GN 1/3 / single ring GN 1/3 / aro sencillo GN 1/3 / cercle simple GN 1/3

11524	14,80
-------	-------

Einzelring GN 1/2 / single ring GN 1/2 / aro sencillo GN 1/2 / cercle simple GN 1/2

11523	20,00
-------	-------

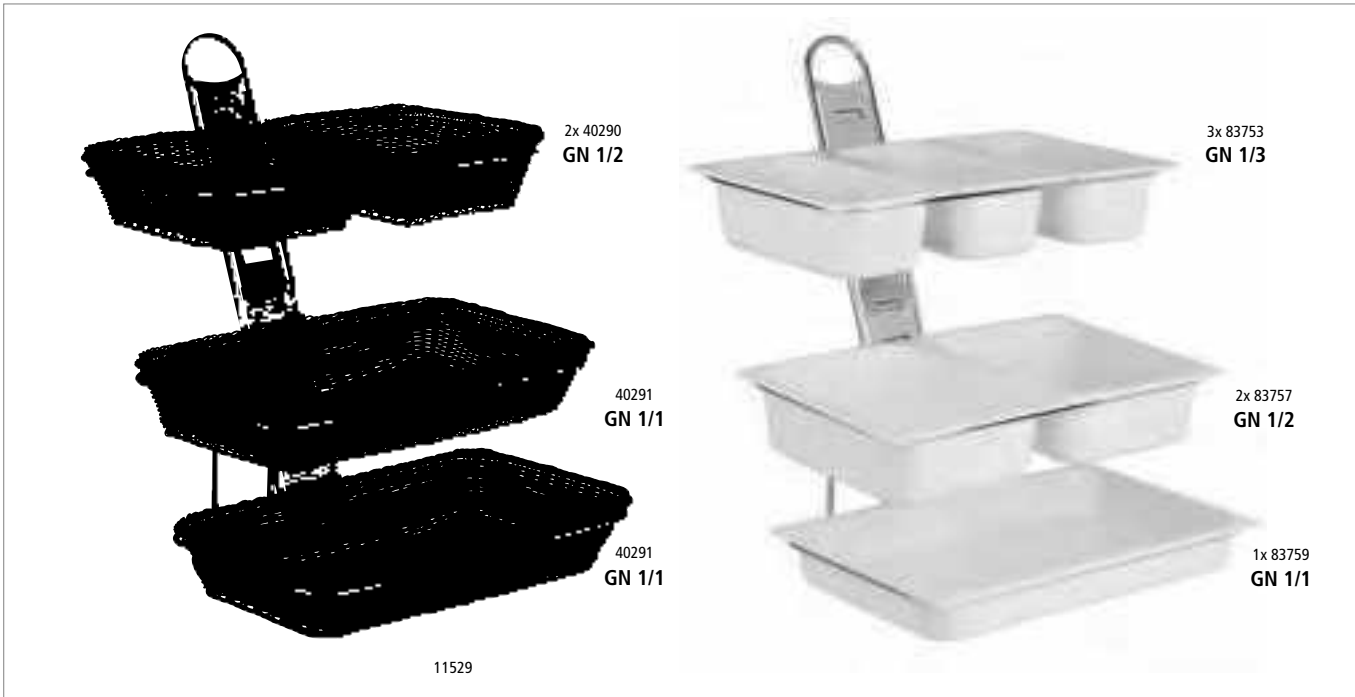

Buffetleiter „BIG GN 1/1“

buffet ladder
dispensador en escalera
présentoir buffet en escalier

4-teilig: 1 Leiter-Gestell, 3 GN 1/1 Rahmen

4 pcs.: 1 ladder, 3 single rings GN 1/1

set de 4: 1 soporte escalera, 3 aros sencillos GN 1/1

set de 4: 1 support escalier, 3 cercles simples GN 1/1



	cm	↑ cm	fits to	€
11529	52 x 59	66	baskets / pans GN 1/1	160,00

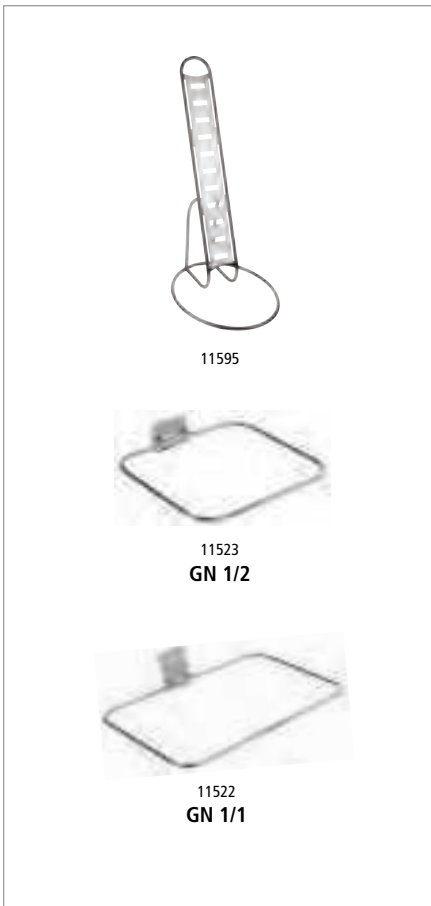

Einzelteile / spare parts / piezas sueltas / pièces détachées

Leitergestell / frame / marco de escalera / échelle support

11595	€
	110,00

Einzelring GN 1/2 / single ring GN 1/2 / aro sencillo GN 1/2 / cercle simple GN 1/2

11523	€
	20,00

Einzelring GN 1/1 / single ring GN 1/1 / aro sencillo GN 1/1 / cercle simple GN 1/1

11522	€
	31,00

BUFFET LADDERS



Buffetleiter „BIG“

buffet ladder
dispensador en escalera
présentoir buffet en escalier



12-teiliges Set: 4 Glasschalen Ø 23 cm 2,5 Liter, 4 klappbare Schutzdeckel mit Beschriftungsfenster, 1 Leiter, 1 Doppelring, 2 Einzelringe, einfach und individuell zusammensetzbar

12 pcs. set: 4 glass bowls Ø 23 cm 2.5 litres, 4 hinged covers with card for inscription, 1 ladder, 1 double ring, 2 single rings, easy to fix and individual to use
set de 12: 4 cuencos de vidrio Ø 23 cm 2,5 l, 4 tapas abatibles con ventana para etiqueta, 1 soporte escalera, 1 aro doble, 2 aros sencillos, fácil de montar, posible usar individualmente
set de 12: 4 bols en verre Ø 23 cm 2,5 l, 4 couvercles à charnière et fenêtre pour étiquette, 1 support escalier, 1 cercle double, 2 cercles simples, montage facile, utilisable individuellement

	cm	↑ cm	€
11598	39 x 31	66	210,00



Buffetleiter „BIG“

buffet ladder
dispensador en escalera
présentoir buffet en escalier



11-teiliges Set: 6 Glasschalen Ø 23 cm 2,5 Liter, 1 Leiter, 2 Doppelringe, 2 Einzelringe, einfach und individuell zusammensetzbar

11 pcs. set: 6 glass bowls Ø 23 cm 2.5 litres, 1 ladder, 2 double rings, 2 single rings, easy and individual to use
set de 11: 6 cuencos de vidrio Ø 23 cm 2,5 l, 1 soporte escalera, 2 aros dobles, 2 aros sencillos, fácil montar, se puede usar individualmente
set de 11: 6 bols en verre Ø 23 cm 2,5 l, 1 support escalier, 2 cercles doubles, 2 cercles simples, montage facile, utilisable individuellement

	cm	↑ cm	€
11599	39 x 31	66	190,00

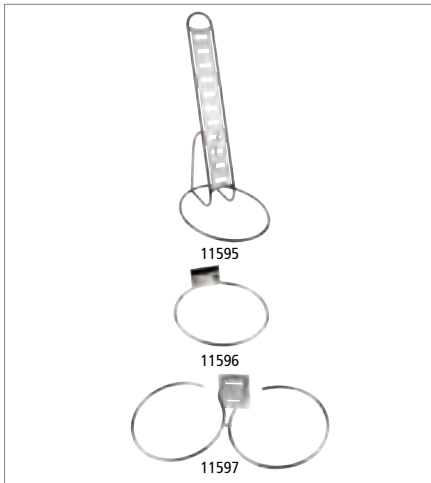

Einzelteile / spare parts / piezas de recambio / pièces détachées

Leitergestell / frame / marco solo / échelle support

	cm	↑ cm	€
11595	39 x 31	66	110,00

Einzelring / single ring / aro sencillo / cercle simple

	Ø cm	€
11596	23,5	15,00

Doppelring / double ring / aro doble / cercle double

	cm	€
11597	48 x 23,5	28,00



Schale

bowl
cuenco
bol



	Ø cm	↑ cm	ltr.	VE / unit	€ / pc.
11875	23,0	10,5	2,50	6	7,00



Schutzdeckel mit Löffelaussparung

cover
tapa
couvercle



	Ø cm	€
11878	23,5	12,60



Buffeteleiter „LITTLE“

buffet ladder
dispensador en escalera
présentoir buffet en escalier



12-teiliges Set: 4 Glasschalen Ø 14 cm 0,5 Liter, 4 klappbare Schutzdeckel mit Beschriftungsfenster, 1 Leiter, 1 Doppelring, 2 Einzelringe, einfach und individuell zusammensetzbar

12 pcs. set: 4 glass bowls Ø 14 cm 0.5 litres, 4 hinged covers with card for inscription, 1 ladder, 1 double ring, 2 single rings, easy and individual to use
set de 12: 4 cuencos de vidrio Ø 14 cm 0,5 l, 4 tapas abatibles con ventana para etiqueta, 1 soporte escalera, 1 aro doble, 2 aros sencillos, fácil montaje, se puede usar individualmente
set de 12: 4 bols en verre Ø 14 cm 0,5 l, 4 couvercles à charnière et fenêtre pour étiquette, 1 support escalier, 1 cercle double, 2 cercles simples, montage facile, utilisable individuellement

	cm	↑ cm	€
11498	30 x 30	48	130,00



Buffeteleiter „LITTLE“

buffet ladder
dispensador en escalera
présentoir buffet en escalier



11-teiliges Set: 6 Glasschalen Ø 14 cm 0,5 Liter, 1 Leiter, 2 Doppelringe, 2 Einzelringe, einfach und individuell zusammensetzbar

11 pcs. set: 6 glass bowls Ø 14 cm 0.5 litres, 1 ladder, 2 double rings, 2 single rings, easy and individual to use
set de 11: 6 cuencos de vidrio Ø 14 cm 0,5 l, 1 soporte escalera, 2 aros dobles, 2 aros sencillos, fácil montaje, se puede usar individualmente
set de 11: 6 bols en verre Ø 14 cm 0,5 l, 1 support escalier, 1 cercles doubles, 2 cercles simples, montage facile, utilisable individuellement

	cm	↑ cm	€
11499	30 x 30	48	110,00

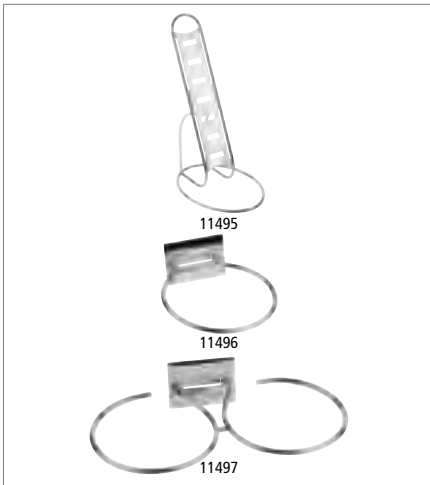

Einzelteile / spare parts / piezas de recambio / pièces détachées

Leitergestell / frame / marco solo / échelle support

	Ø cm	↑ cm	€
11495	30	48	40,00

Einzelring / single ring / aro sencillo / cercle simple

	Ø cm	€
11496	14	10,80

Doppelring / double ring / aro sencillo / cercle double

	cm	cm	€
11497	29,5 x 14,5	48	19,00



Schale

bowl
cuenco
bol



	Ø cm	↑ cm	ltr.	VE / unit	€ / pc.
11865	14	6,5	0,5	6	3,00



Schutzdeckel mit Löffelaussparung

cover
tapa
couvercle



	Ø cm	€
11868	14,5	12,00

BUFFET DISPLAYS



Buffetgestell „SUNDAY“

buffet stand
expositor buffet
présentoir buffet



7-teiliges Set: 3 Glasschalen Ø 23 cm (2,5 Liter), 3 klappbare Schutzdeckel, 1 Gestell

7 pcs. set: 3 glass bowls Ø 23 cm (2,5 litres), 3 hinged covers, 1 stand

set de 7: 3 cuencos de cristal Ø 23 cm (2,5 litro), 3 tapas con bisagra, 1 soporte

set de 7: 3 bols en verre Ø 23 cm (2,5 litre), 3 couvercles à charnière, 1 support

	cm	↑ cm	€
11795	61 x 24	35	136,00



Serviergestell „WECK“

serving stand
expositor
présentoir
ohne Gläser
without glasses
sin tarros
sans verrines



	Ø cm	↑ cm	€
33246	22	59	12 x Ø 6 cm 94,00

passende Gläser / matching glasses / tarros adecuados / verrines appropriées

	Ø cm	↑ cm	ltr.	pcs	€/ set
82310	6	5,5	0,08	12	22,70
82312	6	7,0	0,14	12	24,80
82314	6	8,0	0,16	12	24,80
82370	6	5,5	0,08	12	13,80
82371	6	8,0	0,16	12	14,80



Weck-Gläser mit Deckel, 12er Set

Weck-glasses with lid, 12 pcs.
Weck tarros de vidrio con tapa, set de 12
Weck verrines avec couvercle, set de 12



12 Gläser + 12 Deckel

12 glasses + 12 covers

12 vasos + 12 tapas

12 verrines + 12 couvercles

	Ø cm	↑ cm	ltr.	pcs	€/ set
82310	6	5,5	0,08	12	22,70
82312	6	7,0	0,14	12	24,80
82314	6	8,0	0,16	12	24,80



1,7 ltr.

Dosierspender
dosing dispenser
dosificador
distributeur de dosage



Behälter aus Glas, ideal zum Dosieren von Marmelade, Joghurt und Saucen (ohne Stücke / Fruchtfleisch)
glass container, ideal for dosing jam, yoghurt and sauces (without pieces / pulp)
recipiente de cristal, ideal para dosificar mermelada, yogur y salsas (sin trozos / pulpa)
récipient en verre, idéal pour doser la confiture, le yaourt et sauces (sans morceaux / pulpe)

	Ø cm	↑ cm	ltr.	€
93290	13	31	1,7	24,00



Hubvolumen 15 ml
stroke volume 15 ml



11980
Ständer ohne
Schälchen

83880
Ø 6 cm

Schälchenspender „MINI“
bowl holder
rack dispensador para cuencos
porte-bols



Schälchenspender „MINI“ / bowl holder / rack dispensador para cuencos / porte-bols

	Ø cm	↑ cm		€
11980	14	25,5	Ständer ohne Schalen / frame without bowls soporte sin cuencos / support sans bols	49,00

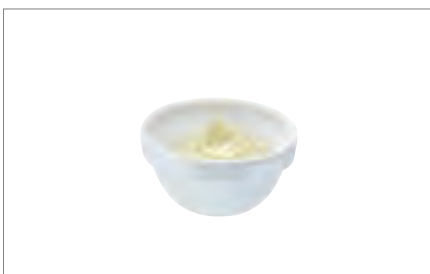

Schälchen „CASUAL MINI“
bowl
cuenco
bol mini



	cm	↑ cm	ltr.	Farbe / Colour	VE / unit	€ / pc.
83880	6,0	2,5	0,02	White	24	2,10



Schale
bowl
cuenco
bol



	Ø cm	↑ cm	ltr.	VE / unit	€ / pc.
11859	6,0	2,5	0,05	36	2,00

BEVERAGE DISPENSERS



3,8 ltr.
14025

7 ltr.
14015

2 x 7 ltr.
14016

Getränkspender „VALO“
beverage dispenser
dispensador de bebidas
distributeur de boissons

GLAS
GLASS

HOLZ
WOOD

EDELSTAHL
STAINLESS
INOX

original
APS
melamine



**Eichenholz (wasserfest lackiert), Zapfhahn aus Edelstahl,
Untersetzer aus Melamin, Bodenplatte (Gläserblech) herausnehmbar**

oak wood (waterproof lacquered), stainless steel tap,
melamine coaster, removeable base plate

madera de roble (lacado impermeable), grifo de acero inoxidable,
posavasos de melamina, placa base extraíble

bois de chêne (vernis imperméable), robinet en acier inox,
dessous de verre en mélamine, plaque de fond amovible

	cm	↑ cm	ltr.	€
14025 <small>NEW</small>	18,0 x 18	41,0	3,8	200,00
14015	21,0 x 21	46,5	7	240,00
14016	43,5 x 21	46,5	2 x 7	390,00



Getränkespender „ELEMENT“

beverage dispenser
dispensador de bebidas
distributeur de boissons

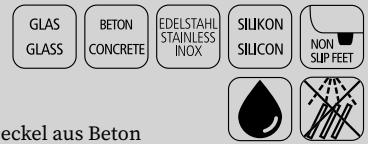

Behälter aus Glas, Zapfhahn aus Edelstahl, Fuß und Deckel aus Beton

glass container, stainless steel tap, stand and lid made of concrete
recipiente de vidrio, grifo de acero inoxidable, soporte y tapa de hormigón
récipient en verre, robinet en acier inox, support et couvercle en béton

7 ltr.

10460



7 ltr.

10400

	Ø cm	↑ cm	Farbe / Colour	ltr.		€
10460 <small>new</small>	22	45	black	7	inkl. Standfuß / incl. stand	130,00
10400	22	45	concrete	7	inkl. Standfuß / incl. stand	130,00



10849

Eiswasserröhre separat erhältlich
ice cube cooling tube available separately



7 ltr.

Getränkespender „ASIA“

beverage dispenser
dispensador de bebidas
distributeur de boissons



Behälter aus Glas, Zapfhahn aus Edelstahl, Fuß und Deckel aus Holz

glass container, stainless steel tap, wooden stand and lid
recipiente de vidrio, grifo de acero inoxidable, soporte y tapa de madera
récipient en verre, robinet en acier inox, support et couvercle en bois

	Ø cm	↑ cm	ltr.		€
10403	24,5	45,5	7	inkl. Gestell / incl. stand	98,00

Ersatz-Fuß / base / soporte de recambio / support de remplacement

	Ø cm	↑ cm		€
10404	24,5	15		26,00

Ersatz-Deckel / replacement lid / tapa de recambio / couvercle de rechange

	Ø cm	↑ cm		€
10405	14,0	5		10,40

BEVERAGE DISPENSERS



Getränkespender „INDUSTRIAL“

beverage dispenser
dispensador de bebidas
distributeur de boissons



Behälter aus Glas, Deckel und Zapfhahn aus Edelstahl, Gestell aus Metall
glass container, stainless steel lid and tap, metal frame
recipiente de vidrio, tapa y grifo de acero inoxidable, soporte metálico
récipient en verre, couvercle et robinet en acier inox, support en métal

	Ø cm	↑ cm	ltr.		€
10452 <small>NEW</small>	16	40	3,8	inkl. Gestell / incl. stand	86,00
10450	20	45	7	inkl. Gestell / incl. stand	110,00



Eiswasserröhre separat erhältlich
ice cube cooling tube available separately



Getränkespender „URBAN“

beverage dispenser
dispensador de bebidas
distributeur de boissons



Behälter aus Glas, Zapfhahn aus Edelstahl, Fuß und Deckel aus Metall, schwarz, Antirutschmatte aus Silikon

glass container, stainless steel tap, base and lid in black metal, silicone non-slip mat
recipiente de vidrio, grifo de acero inoxidable, base y tapa de metal negro, tapete antideslizante de silicona

récipient en verre, robinet en acier inox, pied et couvercle en métal noir, tapis antidérapant en silicone

	Ø cm	↑ cm	ltr.		€
10451	22	45	7	inkl. Gestell / incl. stand	110,00



Antirutschmatte aus Silikon
silicone anti-slip mat



Getränkspender
beverage dispenser
dispensador de bebidas
distributeur de boissons



Behälter aus Glas, Zapfhahn aus Edelstahl, Deckel aus Edelstahl
glass container, stainless steel tap, lid in stainless steel
recipiente de vidrio, grifo de acero inoxidable, tapa de acero inoxidable
récipient en verre, robinet en acier inox, couvercle en acier inox

	Ø cm	↑ cm	ltr.	€
10818	16	25,0	3,8	49,00
10855	20	30,5	7,0	76,00



Eiswasserröhre separat erhältlich
ice cube cooling tube available separately



Untersetzer
saucer
plattillo
sous-assiette



Untersetzer für Getränkspender, schützt den Untergrund vor Wasserrändern
saucer for beverage dispensers, protects the surface from water marks
plattillo para dispensadores de bebidas, protege la superficie de las marcas de agua
sous-assiette pour distributeurs de boissons, protège le support des bords de l'eau

	Ø cm	↑ cm	fits to	€
85233 <small>new</small>	16	1	10818	7,00
85232	19	1	10855	8,40



Antirutschfüße
non slip feet



Tropfenschale, 2-teilig
drip tray, 2 pcs.
aros anti-goteo, set de 2
anneaux coupe-gouttes, set de 2



	Ø cm	↑ cm	Farbe / Colour	€
10851	9,5	1,5	white	8,00
10841	9,5	1,5	black	8,00



Eiswasserröhre
ice cube cooling tube
tubo enfriador para cubitos
tube pour glaçons



	Ø cm	↑ cm	passend für Getränkspender / fits to beverage dispensers	€
10849	11	23	10400, 10403, 10450, 10451, 10452, 10460, 10818, 10855, 14015, 14016, 14025	9,40

BEVERAGE DISPENSERS



10,5 ltr.

Getränkespender „FRUITS“

beverage dispenser
dispensador de bebidas
distributeur de boissons



Behälter aus Glas, Zapfhahn aus Edelstahl, Gestell schwarz

glass container, stainless steel tap, black stand

recipiente de vidrio, grifo de acero inoxidable, soporte negro

réceptien en verre, robinet en acier inox, support noir

	Ø cm	↑ cm	ltr.		€
10415	25	58	10,5	inkl. Gestell / incl. stand	98,00

Ersatz-Deckel / replacement glass / cristal de recambio / vitre de rechange

	Ø cm	↑ cm		€
10418	14	12		10,00

Ersatz-Glas inklusive Deckel, ohne Zapfhahn / replacement glass with lid without tap / cristal de recambio con tapa sin grifo / vitre de rechange avec couvercle sans robinet

	Ø cm	↑ cm	ltr.		€
10417	25	42	10,5		43,00

Ersatz-Zapfhahn / replacement tap / grifo de recambio / robinet de rechange

				€
10718				26,00

Ersatz-Gestell / stand / soporte de recambio / support de remplacement

	Ø cm	↑ cm		€
10416	26	19		28,00



7 ltr.

Getränkespender „OLD FASHIONED“

beverage dispenser
dispensador de bebidas
distributeur de boissons



Behälter aus Glas, Zapfhahn aus Edelstahl, Gestell schwarz

glass container, stainless steel tap, black stand

recipiente de vidrio, grifo de acero inoxidable, soporte negro

réceptien en verre, robinet en acier inox, support noir

	Ø cm	↑ cm	ltr.		€
10409	27	50,5	7	inkl. Gestell / incl. stand	90,00

Ersatz-Gestell / stand / soporte de recambio / support de remplacement

	Ø cm	↑ cm		€
10410	27	31,5		17,00

Ersatz-Glas / replacement glass / cristal de recambio / vitre de rechange

	Ø cm	↑ cm	ltr.		€
10411	19	36,5	7		49,00

Ersatz-Zapfhahn / replacement tap

				€
10718				26,00



Saftdispenser „BRIDGE“

juice dispenser
dispensador de zumo
distributeur à jus



Kühlung durch 2 Kühllakkus von oben und unten

cooling with 2 cooling elements from the top and base

2 acumuladores de frío: 1 en la base y 1 en la tapa

2 accumulateurs de froid: 1 dans le couvercle et 1 dans le socle

	cm	↑ cm	ltr.	Farbe / Colour	€
10870	31,0 x 20	42	4	Ahorn / maple	239,00
10871	35,5 x 22	50	6	Ahorn / maple	279,00



inklusive 3 Magnetschilder: ORANGE, APPLE, GRAPEFRUIT
including 3 magnetic signs: ORANGE, APPLE, GRAPEFRUIT



Saftdispenser „BRIDGE“

juice dispenser
dispensador de zumo
distributeur à jus



Kühlung durch 2 Kühllakkus von oben und unten

cooling with 2 cooling elements from the top and base

2 acumuladores de frío: 1 en la base y 1 en la tapa

2 accumulateurs de froid: 1 dans le couvercle et 1 dans le socle

	cm	↑ cm	ltr.	Farbe / Colour	€
10872	31,0 x 20	42	4	Buche / beech	239,00
10873	35,5 x 22	50	6	Buche / beech	279,00



inklusive 3 Magnetschilder: ORANGE, APPLE, GRAPEFRUIT
including 3 magnetic signs: ORANGE, APPLE, GRAPEFRUIT

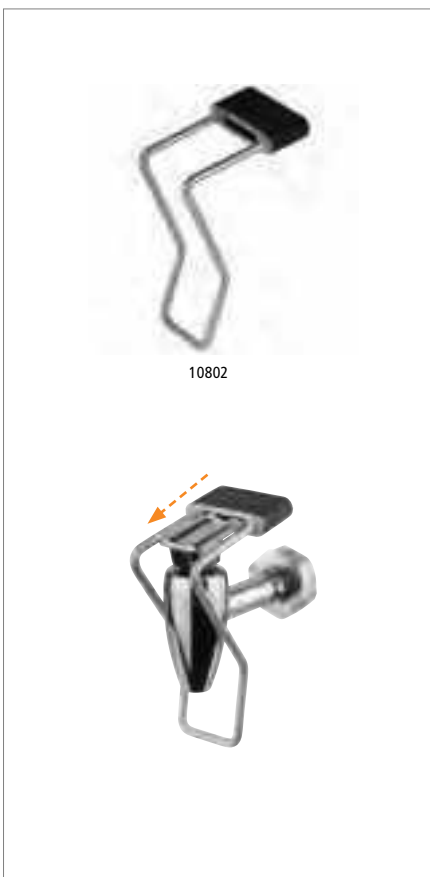

Adapter „TOP FRESH“

adapter
adaptador
adaptateur



handkontaktloser Adapter, einfach zu installieren

adapter touchless for tap, easy to install

adaptador sin contacto para grifo

adaptateur sans contact manuel, facile à installer

	cm	↑ cm	€
10802	12 x 4,5	5,5	10,00



Einfach den Adapter an der dafür vorgesehenen Öffnung auf den Hebel des Zapfhahns stecken.

Simply plug the adapter onto the lever of the tap at the opening provided.

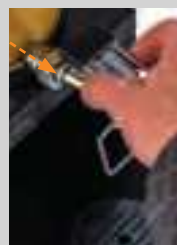

Anschließend den Adapter nach unten festziehen. Durch das Nach-Vorne-Drücken des unteren Edelstahlbügels mit Hilfe des Glases, wird der Hebel des Zapfhahns betätigt und das Getränk fließt völlig handkontaktlos in das Glas.

Then tighten the adapter downwards. By pushing the lower stainless steel bracket forward with the help of the glass, the lever of the tap is activated and the drink flows into the glass completely without hand contact.

BEVERAGE DISPENSERS



10800 4 ltr.

10700 6 ltr.

Saftdispenser „TOP FRESH“

juice dispenser
dispensador de zumo
distributeur à jus de fruit



hochglanzpoliert, Kühlung durch 2 Kühlakkus von oben und unten

mirror polished, cooling with 2 cooling elements from the top and base

pulido brillante, con 2 acumuladores de frío, 1 arriba y 1 en la base

poli brillant, 2 accumulateurs de froid, 1 dans le couvercle, 1 dans le socle

	cm	↑ cm	ltr.	€
10800	21 x 32	43	4	248,00
10700	23 x 35	52	6	350,00



2 x 6 ltr.

Saftdispenser DUO „TOP FRESH“

juice dispenser
dispensador de zumo
distributeur à jus de fruit



hochglanzpoliert, Kühlung durch 2 Kühlakkus von oben und unten

mirror polished, cooling with 2 cooling elements from the top and base

pulido brillante, con 2 acumuladores de frío, 1 arriba y 1 en la base

poli brillant, 2 accumulateurs de froid, 1 dans le couvercle, 1 dans le socle

	cm	↑ cm	ltr.	€
10720	42 x 32	52	2 x 6	514,00



1) Deckel / cover / tapa / couvercle		
	für ltr. / for ltr. / para ltr. / pour ltr.	€
10701	6	27,00
10801	4	23,00

2) Kühlakku / cooler / acumulador de frío / accumulateur de froid		
	für ltr. / for ltr. / para ltr. / pour ltr.	€
10777	4 / 6	5,40

3) Behälter inklusive Zapfhahn / container incl. tap recipiente con grifo / récipient avec robinet		
	für ltr. / for ltr. / para ltr. / pour ltr.	€
10703	6	178,00
10803	4	152,00

3) Behälter ohne Zapfhahn / container without tap recipiente sin grifo / récipient sans robinet		
	für ltr. / for ltr. / para ltr. / pour ltr.	€
10704	6	134,00
10804	4	112,00

4) Non-Drip Hahn / non-drip tap / grifo anti-goteo / robinet anti-goutte		
	für ltr. / for ltr. / para ltr. / pour ltr.	€
10707	6	53,00
10807	4	52,00

5) Einsatz / insert / aro inox / cercle inox		
	für ltr. / for ltr. / para ltr. / pour ltr.	€
10708	6	4,40
10808	4	4,40

6) Standfuß 18/10 Edelstahl / column 18/10 stainless steel base inox 18/10 / socle inox 18/10		
	für ltr. / for ltr. / para ltr. / pour ltr.	€
10709	6	74,00
10809	4	56,00

7) Tropfgitter 18/10 Edelstahl / drip lattice 18/10 stainless steel rejilla recoge gotas 18/10 / grille ramasse-gouttes 18/10		
	für ltr. / for ltr. / para ltr. / pour ltr.	€
10712	6	26,00
10713	DUO	46,00
10812	4	23,00

8) Bodenplatte 18/10 Edelstahl / footing 18/10 stainless steel base de 18/10 acero / socle inox 18/10		
	für ltr. / for ltr. / para ltr. / pour ltr.	€
10710	6	51,00
10711	DUO / 6 + 6	108,00
10814	4	35,00

1 x Dichtung, 2 x Dichtungsring (transparent), 1 x Dichtungsring (s / w)
1 x seal, 2 x sealing ring (transparent), 1 x sealing ring (b / w)

Zubehör / Reinigungsset - für die regelmäßige Reinigung		
		€
10714	für Zapfhahn 10707	4,20
10715	für Zapfhahn 10807	4,20
10716	für Zapfhahn 10907	5,60



BEVERAGE DISPENSERS



7,5 ltr.

300 ml

7,5 ltr.

Getränkespender „NORDIC WOOD“

beverage dispenser
dispensador de bebidas
distributeur de boissons



Behälter mit Edelstahlzapfhahn und Korkdeckel,
stabiles Glas, inklusive Bambus-Standfuß und Kork-Untersetzer

container with stainless steel tap and cork cover, solid glas, including bamboo base and cork coaster

recipiente con grifo de acero inoxidable y tapa de corcho, cristal sólido, incluye soporte de bambú y posavasos de corcho

réipient avec robinet en acier inox et couvercle en liège, verre robuste, y compris pied en bambou et dessous de verre en liège

	cm	↑ cm	ltr.	€
10435	23 x 23	60,5	7,5	106,00

Trinkbecher „CRYSTAL“
drinking cup / vaso / gobelet



	Ø cm	↑ cm	ltr.	VE	€ / pc.
10501	8	12,5	0,3	48	4,20

Ersatzteile Getränkspender „NORDIC WOOD“

parts beverage dispenser
recambios dispensador de bebidas
pièces distributeur de boissons

Ersatz-Deckel / replacement lid / tapa de recambio / couvercle de rechange

	Ø cm	↑ cm	€
10428	11,5	1,5	5,90

Ersatz-Glas inklusive Zapfhahn / replacement glass with tap / cristal de recambio con grifo / vitre de rechange avec robinet

	Ø cm	↑ cm	ltr.	€
10427	17	46	7,5	57,00

Ersatz-Untersetzer aus Kork / replacement cork coaster / posavasos de corcho de recambio / soucoupes de liège de rechange

	Ø cm	↑ cm	€
10424	16,5	1,5	6,00

Ersatz-Gestell / stand for / soporte de recambio / support de remplacement

	cm	↑ cm	Farbe / Colour	€
10426	23 x 23	14		23,00



4,5 ltr.

300 ml



4,5 ltr.

Getränkespender „FRESH WOOD“

beverage dispenser
dispensador de bebidas
distributeur de boissons



Behälter mit Edelstahlzapfhahn und Korkdeckel, stabiles Glas, inklusive Bambus-Standfuß und Kork-Untersetzer

container with stainless steel tap and cork cover, solid glas, including bamboo base and cork coaster

recipiente con grifo de acero inoxidable y tapa de corcho, cristal sólido, incluye soporte de bambú y posavasos de corcho

réipient avec robinet en acier inox et couvercle en liège, verre robuste, y compris pied en bambou et dessous de verre en liège

	cm	↑ cm	ltr.	€
10430	23 x 23	56,5	4,5	106,00

Trinkbecher „CRYSTAL“
drinking cup / vaso / gobelet



	Ø cm	↑ cm	ltr.	VE	€/ pc.
10501	8	12,5	0,3	48	4,20

Tropfenschale / drip tray / aro anti-goteo / anneau coupe-gouttes



	Ø cm	↑ cm	Farbe / Colour	€
10851	9,5	1,5	White	8,00

Ersatzteile Getränkspender „FRESH WOOD“

spare parts beverage dispenser
recambios dispensador de bebidas
pièces distributeur de boissons

Ersatz-Deckel / replacement lid / tapa de recambio / couvercle de rechange

	Ø cm	↑ cm	Farbe / Colour	€
10428	11,5	1,5	Orange	5,90

Ersatz-Glas inklusive Zapfhahn / replacement glass with tap / cristal de recambio con grifo / vitre de rechange avec robinet

	Ø cm	↑ cm	ltr.	€
10422	15,5	42,0	4,5	55,00

Ersatz-Untersetzer aus Kork / replacement cork coaster / posavasos de corcho de recambio / soucoupes de liège de rechange

	Ø cm	↑ cm	€
10424	16,5	1,5	6,00

Ersatz-Gestell / stand for / soporte de recambio / support de remplacement

	cm	↑ cm	Farbe / Colour	€
10426	23 x 23	14	Orange	23,00

BEVERAGE DISPENSERS



Saftdispenser „TOWER“

juice dispenser
dispensador de zumo
distributeur à jus de fruit

aus Edelstahl, inklusive Crushed Ice Röhre
made of stainless steel, inclusive crushed ice tube
de acero inoxidable con tubo para hielo picado
en acier inox avec tube de glace pilée



	cm	↑ cm	ltr.	€
10440	35 x 23	75	5	330,00



Saftdispenser „INOX STAR“

juice dispenser
dispensador de zumo
distributeur à jus de fruit

Edelstahl-Crushed Ice Röhre herausnehmbar
removable stainless steel crash ice tube
con tubo inox refrigerante extraíble para hielo picado
avec tube inox réfrigérant amovible pour glace pilée



	cm	↑ cm	ltr.	€
10795	36 x 26	55	8	190,00

Behälter / container / recipiente / récipient

	Ø cm	ltr.	€
10796	22	8	35,70



Milchdispenser „BRIDGE“

milk dispenser
dispensador de leche
distributeur à lait

Edelstahl Dispenser mit 1 Kühlakku im Standfuß inklusive touchless adapter
stainless steel dispenser with 1 cooling element in stand including touchless adapter
dispensador de acero inoxidable con 1 acumulador de frío en la base y con adaptador sin contacto para grifo
distributeur en acier inox avec 1 accumulateur de froid dans le socle et avec adaptateur sans contact manuel



	cm	↑ cm	ltr.	Farbe / Colour	€
10836	31 x 20	39	3	Ahorn / maple	279,00
10838	39 x 22	45	5	Ahorn / maple	444,00



Milchdispenser „BRIDGE“

milk dispenser
dispensador de leche
distributeur à lait

Edelstahl Dispenser mit 1 Kühlakku im Standfuß inklusive touchless adapter
stainless steel dispenser with 1 cooling element in stand including touchless adapter
dispensador de acero inoxidable con 1 acumulador de frío en la base y con adaptador sin contacto para grifo
distributeur en acier inox avec 1 accumulateur de froid dans le socle et avec adaptateur sans contact manuel



	cm	↑ cm	ltr.	Farbe / Colour	€
10837	31 x 20	39	3	Buche / beech	279,00
10839	39 x 22	45	5	Buche / beech	444,00



Milchkanne „TOP FRESH“

milk dispenser
dispensador de leche
distributeur à lait



hochglanzpoliert, 1 Kühlakku im Standfuß, „original Milchkanne mit Henkel“

mirror polished, 1 cooler in base, original milkcan
pulido brillante, 1 acumulador de frío en la base, recipiente „lechera“
poli brillant, 1 accumulateur de froid dans le socle, design „pot à lait“

	cm	↑ cm	ltr.	€
10830	21 x 32	39	3	320,00
10750	23 x 35	45	5	510,00

Milchkanne ohne Zapfhahn / milkcan without tap / jarra de leche sin grifo / récipient à lait sans robinet

	Ø cm	↑ cm	ltr.	€
10833	16	22	3	174,00
10663	22	26	5	210,00



Milchkanne „TOP FRESH“

milk dispenser
dispensador de leche
distributeur à lait



inklusive Porzellanschild zum Beschriften, 1 Kühlakku im Fuß

including porcelain sign, 1 cooler in base
incluye cartelito en porcelana, 1 acumulador de frío en la base
indicateur en porcelaine inclus, 1 accumulateur de froid dans le socle

	cm	↑ cm	ltr.	€
10850	31 x 21	42	4	300,00



Milchkanne „TOP FRESH“

milk dispenser
dispensador de leche
distributeur à lait



Buchenholz versiegelt, inklusive Porzellanschild zum Beschriften, 1 Kühlakku im Fuß

beech wood, waterproof, incl. porcelain sign, 1 cooler in base
madera de haya, resistente al agua, incluye placa de porcelana, 1 acumulador de frío en la base
socle bois hêtre traité, indicateur en porcelaine inclus, 1 accumulateur de froid dans le socle

	cm	↑ cm	ltr.	€
10840	23 x 32	42	4	300,00



Iso-Dispenser

insulated dispenser
dispensador isotérmico
distributeur de boisson isothermique



für heiße und kalte Getränke / for hot and cold drinks / para bebidas frías y calientes / pour boissons chaudes ou froides

	Ø cm	↑ cm	ltr.	€
10788	24	42	9,5	62,00

Hahn / tap / grifo / robinet

10789				12,00
-------	--	--	--	-------

einklappbare Füße
foldable feet



CARAFES



Glaskaraffe glass carafe jarra de vidrio carafe en verre

GLAS KORK
GLASS CORK

	Ø cm	↑ cm	ltr.	fits to	Design	€
10738	8	28	0,75	14019	LINES	22,00
10739	8	28	0,75	14019	DOTS	22,00

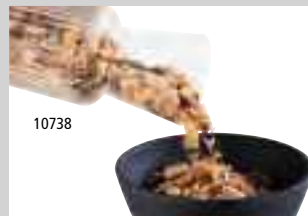

Präsentationsmöglichkeit
presentation example



Detailansicht
detail view „LINES“



Detailansicht
detail view „DOTS“



inklusive Korkdeckel
inclusive cork cover



1er-Podest für Glaskaraffen „VALO“

podest for 1 glass carafes
pedestal de 1 para jarra de vidrio
podium pour 1 pichets en verre

HOLZ WOOD

Eichenholz (geölt), ideal für eine stets geordnete Präsentation am Buffet

oak wood (oiled), ideal for a constantly organised presentation at the buffet
madera de roble (aceitada), ideal para una presentación constantemente organizada en el bufé
chêne (huilé), idéal pour une présentation toujours ordonnée au buffet

	cm	↑ cm	fits to	€
14019	15 x 15	12	10738, 10739	15,00

NEW



10725

0,5 ltr.



10726

1,0 ltr.



10727

1,5 ltr.

Glaskaraffe „LINES“

glass carafe
jarra de vidrio
carafe en verre

GLAS
GLASS

KORK
CORK

ideal für Cerealien, Säfte oder Milch, Deckel aus Kork

ideal for cereals, juices or milk, cork lid

ideal para cereales, zumos o leche, tapa de corcho

idéal pour les céréales, les jus de fruits ou le lait, couvercle en liège

	Ø cm	↑ cm	ltr.	fits to	€
10725	9	19,5	0,5	14023	16,00
10726	9	27,5	1,0	14023	23,00
10727	9	35,0	1,5	14023	24,00



10725

NEW



3er-Podest für Glaskaraffen „VALO“

podest for 3 glass carafes
pedestal de 3 para jarra de vidrio
podium pour 3 pichets en verre

HOLZ
WOOD



Eichenholz (geölt), ideal für eine stets geordnete Präsentation am Buffet

oak wood (oiled), ideal for a constantly organised presentation at the buffet

madera de roble (aceitada), ideal para una presentación constantemente organizada en el bufé

chêne (huilé), idéal pour une présentation toujours ordonnée au buffet

	cm	↑ cm	fits to	€
14023	41 x 16	12	17025, 17026, 17027	49,00



CARAFES



Glaskaraffe

glass carafe
jarra de vidrio
carafe en verre



Deckel aus Edelstahl matt poliert, Ausgießer für tropffreies Ausgießen
lid made of matt polished stainless steel, spout for drip-free pouring
tapa de acero inoxidable pulido mate, pico para verter sin gotear
couvercle en acier inox poli mat, bec verseur pour verser sans goutter

	Ø cm	↑ cm	ltr.	€
10721	8	25	1,0	16,00
10722	8	32	1,3	18,20



Glaskaraffe

glass carafe
jarra de vidrio
pichet en verre



der Deckel öffnet sich beim Ausgießen automatisch
cover opens automatically while pouring
la tapa se abre automáticamente durante el vertido
le couvercle s'ouvre seul pendant le service

	Ø cm	↑ cm	ltr.	€
10766	9,5	29	1	24,00



Soft- / Wasserkanne

juice / water pitcher
jarra de zumo / agua
pichet à eau ou jus de fruit



Deckel aus Edelstahl matt poliert, Ausgießer für tropffreies Ausgießen
stainless steel cover, matt polished, spout for drip-free pouring
tapa de acero inoxidable pulido mate, pico para verter sin gotear
couvercle en acier inox poli mat, bec verseur pour verser sans goutter

	Ø cm	↑ cm	ltr.	€
10764	9,5	27	1,5	25,60



Soft- / Wasserkanne

juice / water pitcher
jarra de zumo / agua
pichet à eau ou jus de fruit



Deckel aus Edelstahl matt poliert, mit integriertem Auffangsieb für Kerne oder Eis
lid made of matt polished stainless steel, with integrated strainer for cores or ice
tapa de acero inoxidable pulido mate, con filtro integrado para los huesos o el hielo
couvercle en acier inox poli mat, avec filtre intégré pour les pépins ou la glace

	Ø cm	↑ cm	ltr.	€
10792	10	26	1,5	21,00



Deckel mit Doppelfunktion
lid with double function



Wasserkanne

water pitcher
jarra de agua
pichet à eau



hochglanzpoliert, mit Ausgieß-Stopper für Eiswürfel oder Früchte
mirror-polished, with pouring stopper for ice cubes or fruit
pulido brillante, con tope vertedor para cubios de hielo o fruta
poli brillant, avec arrêt de versement pour les glaçons ou les fruits

	Ø cm	↑ cm	ltr.	€
10695	9	27,5	1,2	21,00



Saft- / Wasserkanne

juice / water pitcher
jarra de zumo / agua
pichet à eau ou jus de fruit



Deckel mit Auffangsieb für Kerne oder Eis
lid with integrated strainer for cores or ice
tapa con filtro integrado para los huesos o el hielo
couvercle avec filtre intégré pour les pépins ou la glace

	Ø cm	↑ cm	ltr.	€
10691	12	26	1,8	14,80



Saft- / Wasserkanne

juice / water pitcher
jarra de zumo / agua
pichet à jus de fruit / eau

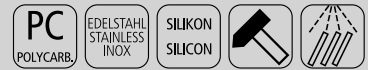

Deckel aus Edelstahl mit Silikondichtung, mit integriertem Auffangsieb für Kerne oder Eis
stainless steel lid with silicone seal, with integrated strainer for cores or ice
tapa de acero inoxidable con junta de silicona, con filtro integrado para los huesos o el hielo
couvercle en acier inox avec joint en silicone, avec filtre intégré pour les pépins ou la glace

	Ø cm	↑ cm	ltr.	€
10692	10	19	1	17,00
10693	11,5	24	1,8	20,00

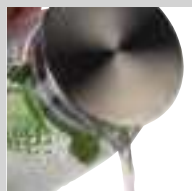

Deckel mit Doppelfunktion
lid with double function

CARAFES



Saft- / Wasserkanne
juice / water pitcher
jarra de zumo / agua
pichet à eau ou jus de fruit

mit Eiswasserröhre
with water ice tube
con tubo para hielo
avec tube à glaçons plongeant pour réfrigérer



	Ø cm	↑ cm	ltr.	€
10770	18	29	3	29,60



Saft- / Wasserkanne
juice / water pitcher
jarra de zumo / agua
pichet à eau ou jus de fruit



	Ø cm	↑ cm	ltr.	€
10775	12	26	2,0	24,00
10776	14	29	2,5	22,00



Saft- / Wasserkanne
juice / water pitcher
jarra de zumo / agua
pichet à eau ou jus de fruit

mit Eiswasserröhre / with water ice tube / con tubo para hielo / avec tube d'eau glacée



	cm	↑ cm	ltr.	€
10769	19 x 13	27	2,8	25,00





1,6 ltr.

Karaffe
bottle
botella
bouteille



Schraubdeckel mit aromadichtem Verschluss

screwed lid, aroma-tight
tapón de rosca, impide la fuga de aromas
bouchon à visser, ne laisse pas passer les arômes

	Ø cm	↑ cm	ltr.	€
10771	11	30	1,6	16,00



10748 1 ltr.

10749 1 ltr.

Flasche „STRIPES“

bottle
botella
bouteille



	Ø cm	↑ cm	ltr.	Farbe / Colour	€
10748	9	28,5	1		13,20
10749	9	28,5	1		13,20



Flaschenverschluss
bottle top

BEVERAGE BOWLS



1,5 ltr.

Pitcher
pitcher
jarra
pichet



	Ø cm	↑ cm	ltr.	€
93105	13	21	1,5	10,40



einfaches Ausgießen
easy pouring out



1,5 ltr.

Pitcher
pitcher
jarra
pichet



	Ø cm	↑ cm	ltr.	€
93091	13,5	20	1,5	10,00



einfaches Ausgießen
easy pouring out



stapelbar
stackable



Flaschenkühler „BIG BOWL“

bottle cooler
enfriador de botella
rafraîchisseur de bouteille



gehämmert, innen matt poliert, herausnehmbarer Tropfeinsatz

hammered, inside matt polished, removable drip tray
martillada, interior pulido mate, bandeja de goteo extraíble
martelée, intérieur poli mat, bac d'égouttage amovible

	Ø cm	↑ cm	ltr.	€
36130	37	23	8	240,00





36111 7 ltr.

36112 7 ltr.

Wein- / Sektkühler „XL“

wine / champagne bowl
cubitera para vino y cava
seau à vin ou champagne

gehämmert, mit 2 seitlichen Eingriffen

hammered, with 2 handles on the side

martillada, con 2 asas

martelée, avec 2 poignées



	cm	↑ cm	ltr.	Farbe / Colour	€
36111	30 x 23,5	23	7	copper-look	65,00
36112	30 x 23,5	23	7	gunmetal-look	65,00



36109 3,9 ltr.

36108 3,9 ltr.

Wein- / Sektkühler „LARGE“

wine / champagne bowl
cubitera para vino y cava
seau à vin ou champagne

gehämmert, mit 2 seitlichen Eingriffen, für 1-2 Flaschen

hammered, with 2 handles on the side, for 1-2 bottles

martillada, con 2 asas, para 1-2 botellas

martelée, avec 2 poignées, pour 1-2 bouteilles



	cm	↑ cm	ltr.	Farbe / Colour	€
36108	25,5 x 19	20	3,9	copper-look	35,00
36109	25,5 x 19	20	3,9	gunmetal-look	35,00



36106 2,1 ltr.

36107 2,1 ltr.

Wein- / Sektkühler „SMALL“

wine / champagne bowl
cubitera para vino y cava
seau à vin ou champagne

gehämmert, für 1 Flasche

hammered, for 1 bottle

martillada, para 1 botella

martelée, pour 1 bouteille



	cm	↑ cm	ltr.	Farbe / Colour	€
36106	20,5 x 14	17	2,1	copper-look	26,00
36107	20,5 x 14	17	2,1	gunmetal-look	26,00



36100 11 ltr.

36095 11 ltr.

Getränkewanne „TIN“

beverage tub
barreño botellines

bassine à glace

Metall verzinkt, mit Kunststoffeinsatz

galvanised metal, with plastic insert

metal galvanizado, con inserto de plástico

métal galvanisé, avec insert en plastique



	cm	↑ cm	ltr.	Farbe / Colour	€
36100	40 x 28	22	11	copper-look	36,00
36101	40 x 28	22	11	black-metal-look	31,00
36095	40 x 28	22	11	metal-look	30,00
36096	50 x 23	23	18	metal-look	36,00



71490

Kreidestift zum Beschriften

chalk marker for writing

S. 348

TEAPOTS



Teekanne „ASIA“

teapot
tetera
théière



aus Gusseisen, innen emailliert, abnehmbarer Deckel, mit Teesieb aus Edelstahl

made of cast iron, enamelled inside, removable lid, with tea strainer made of stainless steel
hierro fundido, interior esmaltado, tapa extraíble, con colador de té de acero inoxidable
en fonte, émaillé à l'intérieur, couvercle amovible, avec une passoire à thé en acier inox

	cm	↑ cm	ltr.	Farbe / Colour	€
10995	17 x 14	17	0,8		26,00
10996	17 x 14	17	0,8		26,00



Teekanne „ASIA“

teapot
tetera
théière



aus Gusseisen, innen emailliert, abnehmbarer Deckel, mit Teesieb aus Edelstahl

made of cast iron, enamelled inside, removable lid, with tea strainer made of stainless steel
hierro fundido, interior esmaltado, tapa extraíble, con colador de té de acero inoxidable
en fonte, émaillé à l'intérieur, couvercle amovible, avec une passoire à thé en acier inox

	cm	↑ cm	ltr.	Farbe / Colour	€
10991	19,5 x 18	15	0,8		26,00
10992	19,5 x 18	15	0,8		26,00



Teekanne „ASIA“

teapot
tetera
théière



aus Gusseisen, innen emailliert, mit abnehmbarem Deckel, ohne Teesieb aus Edelstahl
made of cast iron, enamelled inside, with removable lid, without tea strainer made of stainless steel

hierro fundido, interior esmaltado, con tapa extraíble, sin colador de té de acero inoxidable
en fonte, émaillé à l'intérieur, avec couvercle amovible, sans une passoire à thé en acier inox

	cm	↑ cm	ltr.	Farbe / Colour	€
10990	12,5 x 11	12,5	0,3		21,00

**Stövchen „ASIA“**

teapot warmer
calentador de tetera
chauffe-théière



1-flammiges Stövchen aus Gusseisen mit abnehmbarem Deckel (Lieferung ohne Teelicht).

1-flame cast iron warmer with removable lid (delivery without tealight).

calentador de tetera de hierro fundido con 1 quemador con tapa extraíble (se entrega sin vela).

chauffe-théière en fonte à 1 brûleur avec couvercle amovible (livraison sans bougie).

	Ø cm	↑ cm	€
10994	13	7,5	16,40

Untersetzer aus Gusseisen mit Antirutschfüßchen / cast iron coaster with non-slip feet

	Ø cm	↑ cm	€
10993	13,5	1,5	5,50

**Teebox**

tea-box
caja para té
boîte à thés et infusions



Box aus Rubberwood mit Sichtfenster, mit Aufschrift „Tee“, 4 Kammern können mit je 30 kuvertierten Teebeuteln bestückt werden

rubber wood box with clear transparent window, with inscription „Tee“, 4 chambers for approx. 30 tea bags each

caja de madera de goma clara con ventana transparente, con inscripción „Tee“, 4 compartimentos, y cada uno para aproximadamente 30 bolsitas de té en bois d'hévéa clair avec fenêtre, avec inscription „Tee“, 4 compartiments, pour environ 30 sachets chacun

	cm	↑ cm	Farbe / Colour	€
11575	33,5 x 20	9	light yellow	21,00
11574	33,5 x 20	9	dark brown	21,00

	cm	↑ cm	Farbe / Colour	€
11576	33,5 x 20	9	light yellow	21,00

ohne Aufschrift / without inscription
sin inscripción / sans inscription

**Teebox**

tea-box
caja para té
boîte à thés et infusions



Box aus Rubberwood mit Sichtfenster, mit Aufschrift „Tee“, 12 Kammern können mit je 12 kuvertierten Teebeuteln bestückt werden

rubber wood box with clear transparent window, with inscription „Tee“, 12 chambers for approx. 12 tea bags each

caja de madera de goma clara con ventana transparente, con inscripción „Tee“, 12 compartimentos, y cada uno para aproximadamente 12 bolsitas de té en bois d'hévéa clair avec fenêtre, avec inscription „Tee“, 12 compartiments, pour environ 12 sachets chacun

	cm	↑ cm	Farbe / Colour	€
11775	31 x 28	9	light yellow	28,00
11776	31 x 28	9	dark brown	28,00

**Teebox / Multibox**

tea caddy
caja para té
boîte à thés et infusions



3 Fächer für kuvertierte Teebeutel, 1 Fach für Zucker, Kekse, etc., Deckel aufklappbar

3 compartments for tea bags, 1 compartment for sugar, biscuits, etc., hinged lid

3 compartimentos para bolsitas de té, 1 compartimento para azúcar, galletas, etc. tapa abatible

3 compartiments pour sachets de thé, 1 compartiment pour sucre, biscuits, etc., couvercle abatible

	cm	↑ cm	€
11563	22 x 17	9	21,00

VACUUM JUGS



Deckel klappbar
lid foldable



10924 1,5 ltr.

Isolierkanne „ADVANCED“

vacuum jug
jarra termo
bouteille isotherme



doppelwandig, spülmaschinenfest, Einhandautomatik, aufgeklappt passt die Kanne unter die gängigen Kaffeemaschinen, für heiße und kalte Getränke

double-walled, dishwasher-safe, easy pouring system, with flipped-back lid, the air pot fits under a wide range of coffee makers, for hot and cold beverages

doble pared, resistente al lavavajillas, se maneja con 1 mano, con la tapa abierta la jarra se puede usar con casi todas las cafeteras corrientes, para bebidas frías y calientes

double paroi, résistante au lave-vaisselle, usage à 1 main, avec la couvercle ouverte a bouteille se peut user avec toutes les machines à café courantes, pour boissons chaudes ou froides

	Ø cm	↑ cm	ltr.	Anzahl der Tassen	€
10921	10,5	13,0	0,3	2,5	45,00
10922	10,5	18,0	0,6	5,0	52,00
10923	13,0	19,5	1,0	8,0	58,00
10924	13,0	23,5	1,5	12,0	65,00



10912 2 ltr.

Isolierkanne „CLASSIC“

vacuum jug
jarra termo
bouteille isotherme

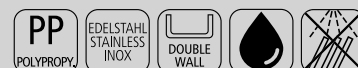

doppelwandig, Einhandautomatik, Drehverschluss, für heiße und kalte Getränke

double-walled, easy push-button pouring system, screw cap, for hot and cold drinks

doble pared, se maneja con 1 mano, con tapa a rosca, para bebidas frías y calientes

double paroi, usage à 1 main, couvercle à visser, pour boissons chaudes ou froides

	Ø cm	↑ cm	ltr.	Anzahl der Tassen	€
10910	14	19	1,0	8	16,90
10911	14	22	1,5	12	18,40
10912	14	25	2,0	16	21,20



10913



10914

Isolierkanne „ECONOMY“

vacuum jug
jarra termo
bouteille isotherme



robuste Umhüllung mit Polypropylen-Kunststoff, Stabilglaseinsatz, Drehverschluss mit Drucktasten-Bedienung für heiße und kalte Getränke, 8 Tassen

double-walled with glass liner, screw cap with easy push-button pouring system, for hot and cold beverages, 8 cups

exterior de plástico polipropileno, interior aislante de vidrio, con tapa a rosca con cierre dosificador para bebidas frías y calientes, 8 tazas

extérieur en plastique polypropylène, intérieur avec plaque de verre, couvercle à visser, pour boissons chaudes ou froides, 8 tasses

	Ø cm	↑ cm	ltr.	Farbe / Colour	€
10913	16	20	1	White	17,40
10914	16	20	1	Black	17,40



10,5 ltr.

Kaffeedispenser „HAPPY HOUR“

coffee dispenser
dispensador de café
distributeur de café



hochglanzpoliert, für warme Getränke, stabil und standfest, inklusive 1 Brennpastenbehälter
mirror polished, for warm drinks, solid and stable, including 1 burner holder
pulido brillante, para bebidas calientes, sólido y estable, incluye un calentador
poli brillant, pour boissons chaudes, robuste et stable, avec 1 brûleur

	cm	↑ cm	ltr.	€
11672	31 x 33,5	54,5	10,5	210,00

Hahn / tap / grifo / robinet

	€
11671	27,00

Elektro-Heizelement / heating unit / resistencia / résistance

	cm	↑ cm	€
12287	21 x 20	6	99,00



Pump-Isolierkanne „PREMIUM“

air pot
jarra termo
bouteille isotherme

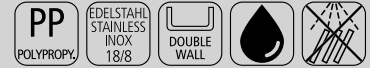

matt poliert, doppelwandig, Tragegriff, Drehverschluss, Pumpmechanismus, Füllstandsanzeigefür heiße und kalte Getränke, inklusive 4 Beschriftungsclips, für 24 Tassen

matt polished, double-walled, carrying handle, screw cap, pump mechanism, fill level indicator, for hot and cold beverages, including 4 beverage signs, for 24 cups

pulido mate, doble pared, asa de transporte, tapón de rosca, mecanismo de bombeo, indicador de nivel para bebidas calientes y frías, con 4 clips para marcar, para 24 tazas

poli mat, double paroi, poignée de transport, fermeture rotative, mécanisme de pompage, indicateur de niveau pour boissons chaudes et froides, avec 4 clips d'inscriptions, pour 24 tasses

	Ø cm	↑ cm	ltr.	Anzahl der Tassen	€
10916	15	37	3	24	70,00

Tropfenfänger für Pump-Isolierkanne / drip tray for air pot / recogegotas para jarra termo / ramasse-gouttes pour bouteilles isotherme

	cm	↑ cm	€
10917	24 x 18,5	4	11,40



Pump-Isolierkanne „BUDGET“

air pot
jarra termo
bouteille isotherme

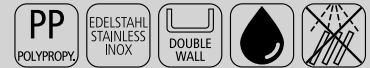

Edelstahl, Polypropylen, matt poliert, doppelwandig, Tragegriff, Dreh-Pumpknopf, für heiße und kalte Getränke, für 17 Tassen

stainless steel, polypropylene, matt polished, double-walled, carrying handle, push-button, for hot and cold beverages, for 17 cups

acero inoxidable, polipropileno, pulido mate, doble pared, asa de transporte, botón giratorio de la bomba, para bebidas calientes y frías, para 17 tazas

acier inox, polypropylène, poli mat, double paroi, poignée de transport, bouton de pompage rotatif, pour boissons chaudes et froides, pour 17 tasses

	Ø cm	↑ cm	ltr.	Anzahl der Tassen	€
10915	13,5	32,5	2,2	17	28,00

NATURAL SLATE



EXTRA STRONG
6-9 mm thickness

Naturschiefer speichert auf natürliche Weise Kälte besonders gut. Die Kanten der Platten sind gebrochen und nicht gesägt.

Natural slate stores cold particularly well in a natural way. The edges of the panels are broken and not sawn.

La pizarra natural almacena el frío especialmente bien de forma natural. Los bordes de las bandejas están rotos y no aserrados.

L'ardoise naturelle stocke particulièrement bien le froid de manière naturelle. Les bords des plateaux sont brisés et non sciés.



3 tlg.
3 pcs.

Kühlbox „SLATE“ refrigerated buffet display expositor buffet frío plateau buffet froid

3-teilig, bestehend aus: 1 Basis aus schwarzem Polystyrol,
1 Naturschieferplatte, 1 Kühlakku (ohne Haube)

3 pcs., set consists of: 1 base made of black polystyrene, 1 natural slate tray,
1 cooler (without cover)

set de 3 compuesto por: 1 soporte de poliestireno negro, 1 bandeja de pizarra natural,
1 acumulador de frío (sin campana)

set de 3 composé de: 1 support en polystyrène noir, 1 plateau en ardoise naturelle,
1 accumulateur de froid (sans couvercle)



	cm	↑ cm	€
11645	58 x 38	6,5	80,00

Naturschieferplatte / natural slate tray / bandeja de pizarra natural / plateau ardoise naturelle

	cm	* mm	€
00979	58 x 38	6 - 9	19,00

Kühlakku / cooler / acumulador de frío / accumulateur de froid

	cm	↑ cm	€
10782	41 x 21	2,5	16,00

Basis / base / soporte / support

	cm	↑ cm	€
11619	52 x 32	5,5	49,00

GN Rolltophaube mit schwarzem Griff / GN rolltop cover with black handle / GN campana rolltop con mango negro / GN cloche rolltop avec poignée noire

	cm	↑ cm	GN	€
11075	53 x 32,5	19	1/1	62,00



GN 1/1 Naturschieferplatte „HOCHSTAPLER“

GN 1/1 natural slate tray
GN 1/1 bandeja de pizarra natural
GN 1/1 plat ardoise naturelle



	cm	↑ cm	* mm	€
00966	53 x 32,5	6	6 - 9	35,80

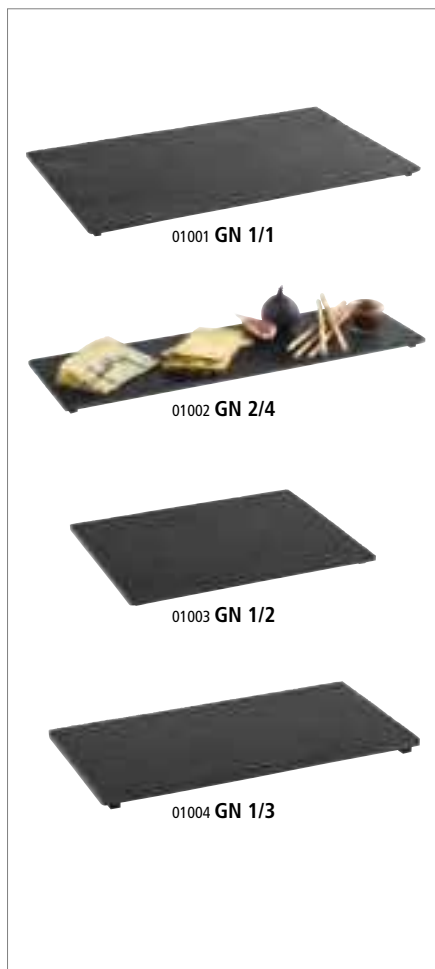

Griffe verchromt, 4 cm Nutzhöhe
chrome plate handles, 4 cm distance

**GN Naturschieferplatte**

GN natural slate tray
GN bandeja pizarra natural
GN plat ardoise naturelle



möbelschonende Unterseite, gerade Kanten

non-scratching undersurface, straight edges

base anti rayaduras, bordes rectos

avec revêtement antirayures, bords rectilignes

	cm	✦ mm	GN	€
01001	53,0 x 32,5	6 - 9	1/1	16,40
01002	53,0 x 16,2	6 - 9	2/4	6,80
01003	32,5 x 26,5	6 - 9	1/2	9,20
01004	32,5 x 17,6	6 - 9	1/3	5,60

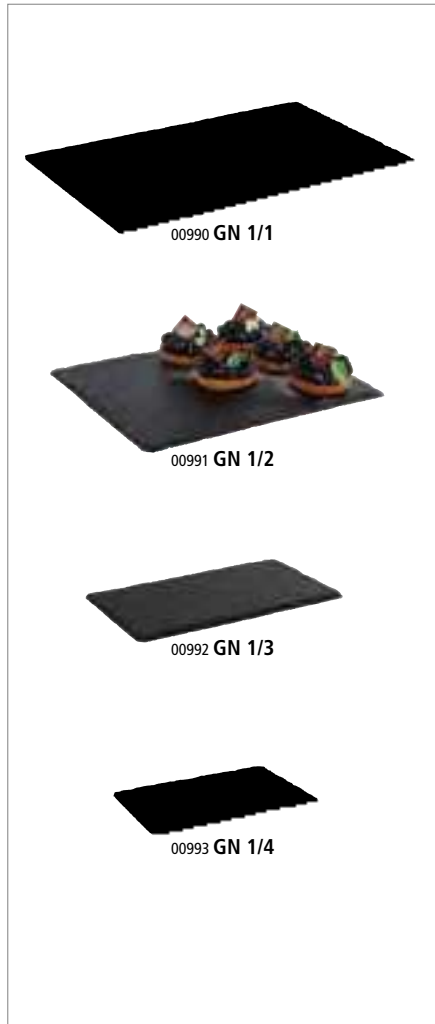

gerade Kanten
straight edges

**GN Naturschieferplatten**

GN natural slate tray
GN bandeja de pizarra natural
GN plat ardoise naturelle



möbelschonende Unterseite, gebrochene Kanten

non-scratching undersurface, broken edges

base anti rayaduras, bordes biselados

avec revêtement antirayures, bords biseautés

	cm	✦ mm	GN	€
00990	53,0 x 32,5	6 - 9	1/1	15,80
00991	32,5 x 26,5	6 - 9	1/2	8,80
00992	32,5 x 17,6	6 - 9	1/3	5,40
00993	26,5 x 16,2	6 - 9	1/4	5,00
00973	53,0 x 16,2	6 - 9	2/4	6,50



gebrochene Kanten
broken edges

SERVING BOARDS | NATURAL SLATE



Naturschieferplatte
 natural slate tray
 bandeja de pizarra natural
 plat ardoise naturelle



	cm	✦ mm		€
00996	45 x 30	6 - 9		12,60
00979	58 x 38	6 - 9	mit Safrille / with juice groove	19,00

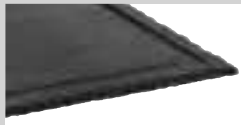

00979 mit Safrille
 00979 with juice groove



Naturschieferplatte
 natural slate tray
 bandeja de pizarra natural
 plat ardoise naturelle



	cm	✦ mm		€
00994	25 x 25	6 - 9		6,40
00995	30 x 30	6 - 9		9,50



Naturschieferplatte
 natural slate
 bandeja de pizarra natural
 plateau ardoise naturelle



	cm	✦ mm	fits to	€
00941	24,0 x 15,0	6 - 9	83417	4,20
00942	26,5 x 20,5	6 - 9	83480	6,40
00945	47,0 x 10,0	6 - 9	83433	6,40
00988	30,0 x 12,0	6 - 9	83403	4,30

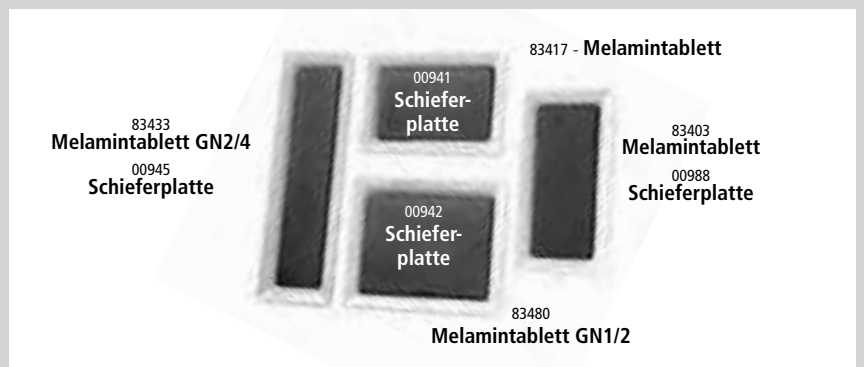



Naturschieferplatte

natural slate tray
bandeja pizarra natural
plat ardoise naturelle

mit Safrille, mit Aussparung Ø 9,5 cm
with juice groove, with hole Ø 9,5 cm
con ranura para líquidos, con agujero Ø 9,5 cm
avec rigole, avec trou Ø 9,5 cm



	cm	mm	€
00947	33 x 24	6 - 9	10,00



mit Safrille
with juice groove

Wachspapier / greaseproof paper squares / papel alimenticio / papier alimentaire

	cm	pcs.	Motiv: Zeitung	€
40670	42 x 25	500		59,00

Servier-Frittierkorb / fry baskets / cestitas para el servicio mesa / paniers pour le service sur table

	Ø cm	↑ cm	Griff / handle cm	Farbe / Colour		€
40601	9	8,5	9,0		stainless steel	11,20
40603	9	8,5	9,0		copper	13,00
40625	9	8,5	9,0		black matt	13,60



Naturschieferplatte

natural slate tray
bandeja pizarra natural
plat ardoise naturelle

mit 3 x Aussparungen, Ø 6 cm
with 3 holes, Ø 6 cm
con 3 agujeros, Ø 6 cm
avec 3 trous, Ø 6 cm



	cm	mm	€
00987	28 x 10	6 - 9	6,20



Naturschieferplatte

natural slate tray
bandeja pizarra natural
plat ardoise naturelle

mit Aussparung, Ø 6 cm
with hole Ø 6 cm
con agujero Ø 6 cm
avec trou Ø 6,0 cm



	cm	mm	€
00986	25 x 12	6 - 9	4,40



Naturschieferplatte / Untersetzer

natural slate tray
bandeja de pizarra natural
plateau ardoise naturelle

mit 2 Aussparungen, Ø 6 cm
with 2 holes Ø 6 cm
con 2 agujeros Ø 6 cm
avec 2 trous Ø 6 cm



	cm	mm	€
00971	15 x 8	6 - 9	3,40

SERVING BOARDS | NATURAL SLATE



Naturschieferplatte „STARTER“
 natural slate tray
 bandeja de pizarra natural
 plat ardoise naturelle



	cm	✱ mm	€
00937	20 x 10	6 - 9	3,10



00969

Naturschieferplatte
 natural slate tray
 bandeja de pizarra natural
 plat ardoise naturelle



	Ø cm	✱ mm	€
00968	22	6 - 9	5,20
00969	28	6 - 9	7,30
00998	33	6 - 9	8,70
00999	38	6 - 9	12,80



Präsentationsmöglichkeit
 presentation example



Tortenplatte / Servierplatte
 cake stand
 soporte para pastel
 présentoir à gâteaux



drehbar
 rotatable
 giratorio
 rotatif

	Ø cm	↑ cm	✱ mm	€
00975	32	2,5	6 - 9	19,60



drehbare Servierplatte
 rotatable cake stand



3 tlg.
 3 pcs.

Rolltop-Set
 rolltop set
 rolltop set
 rolltop set



3-teilig, bestehend aus: 1 Edelstahltablett Ø 38 cm, 1 Naturschieferplatte Ø 33 cm, 1 Rolltophaube Ø 38 cm

3 pcs., set consists of: 1 stainless steel tray Ø 38 cm, 1 natural slate tray Ø 33 cm, 1 rolltop cover Ø 38 cm

set de 3 compuesto por: 1 bandeja de acero inoxidable Ø 38 cm, 1 bandeja de pizarra natural Ø 33 cm, 1 campana abatible Ø 38 cm

set de 3 composé de: 1 plateau en acier inox 38 cm, 1 plateau ardoise naturelle 33 cm, 1 cloche basculante 38 cm

	Ø cm	↑ cm	€/ set
01000	38	24	48,50

**3-stufige Etagère**

3-tier tray
bandeja con tres alturas
étagère carré 3 hauteurs

Naturschiefer, Akazienholz

natural slate tray, wood akazie
bandeja de pizarra natural, madera de acacia
plateau ardoise naturelle, bois d'acacia



	Ø cm	↑ cm	* mm	€
00960	30 / 25 / 20	34	6 - 9	30,00

**2-stufige Etagère**

2-tier tray
bandeja dos alturas
étagère carré 2 hauteurs

Naturschiefer

natural slate tray
bandeja de pizarra natural
plateau ardoise naturelle



	Ø cm	↑ cm	* mm	€
00989	25 / 20	24	6 - 9	15,30

**Naturschieferplatte**

natural slate tray
bandeja de pizarra natural
plateau ardoise naturelle

2-teilig: Naturschieferplatte mit Glashaube

2 pcs.: natural slate tray with glass cover
set de 2: bandeja de pizarra natural con tapa de cristal
set de 2: plateau ardoise naturelle avec cloche en verre

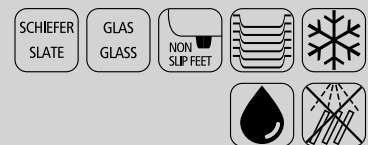

	Ø cm	↑ cm	* mm	€
00984	10,5	8	6 - 9	8,50

**Naturschieferplatten, 4er Set**

natural slate tray, 4 pcs.
bandeja pizarra natural, set de 4
plateau ardoise naturelle, set de 4



	cm	* mm	pcs.	€ / set
00997	10 x 10	6 - 9	4	8,50



HOCHSTAPLER

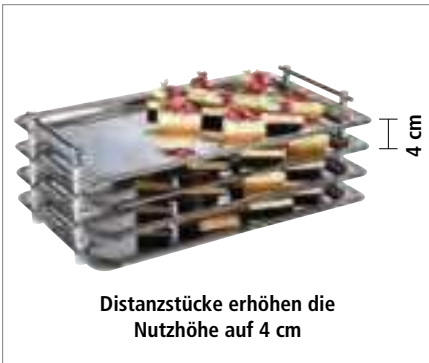

GN 1/1 System-Tablett „PROFI LINE“

GN 1/1 tray
GN 1/1 bandeja
GN 1/1 plateau



Dekorrand, hochglanzpoliert, Griffe verchromt, Distanzstücke erhöhen die Nutzhöhe auf 4 cm
decor edge, mirror polished, chrome plated handles, spacers increase the useful height to 4 cm
borde decorado pulido brillante, asas cromadas, los separadores aumentan la altura útil a 4 cm
bord avec reliefs poli brillant, poignées chromées, les entretoises portent la hauteur utile à 4 cm

	cm	↑ cm	GN	€
11300	53 x 32,5	5,5	1/1	49,00



GN 1/1 System-Tablett „BUFFET-STAR“

GN 1/1 tray
GN 1/1 bandeja
GN 1/1 plateau



Rand hochglanzpoliert, Distanzstücke erhöhen die Nutzhöhe auf 4 cm
mirror polished edge, spacers increase the useful height to 4 cm
borde pulido brillante, los separadores aumentan la altura útil a 4 cm
bord poli brillant, les entretoises portent la hauteur utile à 4 cm

	cm	↑ cm	GN	Griff / handle	€
11150	53 x 32,5	6,5	1/1	silver	40,00
11155	53 x 32,5	6,5	1/1	gold	40,00



GN 1/1 System-Tablett „CLASSIC“

GN tray
GN bandeja
GN plat empilable système catering



Rand hochglanzpoliert, Distanzstücke erhöhen die Nutzhöhe auf 4 cm
mirror polished edge, spacers increase the useful height to 4 cm
borde pulido brillante, los separadores aumentan la altura útil a 4 cm
bord poli brillant, les entretoises portent la hauteur utile à 4 cm

	cm	↑ cm	GN	€
11295	53 x 32,5	5,0	1/1	42,00



GN 1/1 Haube „HOCHSTAPLER“

GN 1/1 cover
GN 1/1 campana
GN 1/1 cloche



glasklarer Kunststoff, Haube fixiert sich auf dem Tablett, nahezu bruchfest
clear plastic, cover fixes itself on the tray, nearly unbreakable
plástico transparente, la tapa se fija a la bandeja para que no se deslice, resistente a la rotura
en plastique transparent, la cloche se fixe sur le dessous du plateau, résistant à la casse

	cm	↑ cm	fits to	GN	€
11305	53 x 32,5	9	11300, 11295	1/1	30,00



GN Behälter „PROFI LINE“

GN pan
GN cubeta
GN bac



	cm	↑ cm	GN	ltr.	€
11020	53,0 x 32,5	2,0	1/1	1,7	34,00
11040	53,0 x 32,5	4,0	1/1	3,4	37,00
11065	53,0 x 32,5	6,5	1/1	7,0	40,00
12065	32,5 x 26,5	6,5	1/2	3,3	26,00



GN Tablett „PROFI LINE“

GN tray
GN bandeja
GN plateau



mit glattem Rand / with smooth edge / borde liso / bord lisse

	cm	↑ cm	GN	€
11100	53,0 x 32,5	1,5	1/1	31,00
12100	32,5 x 26,5	1,5	1/2	17,80

mit Dekor-Rand / with decor-edge / con borde decorado / bords avec relief

	cm	↑ cm	GN	€
11000	53,0 x 32,5	1,5	1/1	31,00
12000	32,5 x 26,5	1,5	1/2	19,60

glatter schmaler Rand / smooth narrow edge / borde estrecho liso / bord étroit lisse

	cm	↑ cm	GN	€
11110	53,0 x 32,5	1,0	1/1	18,60



GN Abdeckhaube

GN cover
GN campana
GN cloche



	cm	↑ cm	✱ mm	GN	€
11041	32,5 x 26,5	9,5	3	1/2	23,00
11042	53,0 x 32,5	9,5	3	1/1	32,00
11043	32,5 x 17,6	10,5	3	1/3	17,00
11044	53,0 x 16,2	10,5	3	2/4	23,00

TRAYS STAINLESS STEEL



Tablett „SCHÖNER ESSEN“

tray
bandeja
plateau



mit Dekorrand, Griffe Zinkdruckguss verchromt, genietet

with decor edge, handles zinc alloy chrome plated, riveted

borde decorado, asas de fundición inyectada de cinc cromado, remachadas

bord décor, poignées en zamac chromé, rivetées

	cm	↑ cm	€
00082	54 x 31,0	3	16,00
00081	62 x 36,0	3	22,00
00084	75 x 44,5	3	38,00



Tablett „SCHÖNER ESSEN“

tray
bandeja
plateau



	cm	↑ cm	GN	€
00383	35,0 x 24,0	1		7,60
00382	42,0 x 31,0	1		11,80
00381	50,0 x 36,0	1		15,00
00384	63,5 x 44,5	1		29,00
00385	60,0 x 40,0	1		27,00
00388	53,0 x 32,5	1	1/1	17,00

leichte Ausführung 0,5 mm / light model / modelo ligero / qualité légère

	cm	↑ cm	€
03824	42,0 x 31,0	1	10,60



Tablett mit Haube „SCHÖNER ESSEN“

tray with cover
bandeja con campana
plateau avec cloche



	cm	↑ cm	€
38202	42 x 31	8	16,80

Haube / cover / campana / cloche

	cm	↑ cm	€
08201	36,5 x 26,0	7,5	5,40



Tablett „FINESSE“

tray
bandeja
plateau

verchromte Messinggriffe / chrome plated brass handles / asas plateadas de latón / poignées en laiton chromées



	cm	↑ cm	€
01712	44 x 31	1,5	22,40



01324 oval

Tablett „FINESSE“

tray
bandeja
plateau



	cm	↑ cm	€
01322	42 x 30	2,5	14,90
01323	50 x 36	2,5	21,60
01324	60 x 41	2,5	30,00



01338

Tablett „FINESSE“

tray
bandeja
plateau



	Ø cm	↑ cm	€
01332	32	1	9,40
01335	35	1	11,00
01338	38	1	12,40
01348	48	1	24,00



01311

Tablett „FINESSE“

tray
bandeja
plateau



	cm	↑ cm	€
01314	30 x 24	1	8,60
01313	35 x 24	1	9,80
01317	39 x 26	1	11,00
01312	42 x 31	1	12,40
01318	48 x 30	1	11,80
01311	50 x 38	1	17,20
01310	58 x 42	1	29,00
01309	68 x 48	1	41,00

TRAYS STAINLESS STEEL



Schale

bowl
cuenco
bol

ingerollter Rand

rolled edge
borde enrollado
bord roulé



	cm	↑ cm	ltr.	€
40110	26,5 x 18,5	4	0,8	9,20



Servierpfanne

pan
fuente para la mesa
plat pour la table

mit vergoldeten Edelstahlgriffen, 1 mm dick

with gold-plated stainless steel handles, 1 mm thick
con asas doradas de acero inoxidable de 1 mm de grosor
avec poignées dorées en acier inox, 1 mm d'épaisseur



	cm	↑ cm	ltr.	€
61190	19	3,5	0,7	16,40
61280	28	4,0	2,0	24,00
61400	40	5,0	4,5	62,00
60270	26,5 x 19,5	3,0	0,8	18,40
60310	31,0 x 21,5	3,0	1,2	23,00



Tablett „ELEGANCE“

tray
bandeja
plateau



	cm	↑ cm	€
02311	48 x 30	1	17,00



Tablett „TREND“

baking sheet
bandeja
plateau

ein Backblech wird zum Serviertablett

a baking sheet which becomes a serving tray
una bandeja de hornear que se convierte en una bandeja de servir
un moule qui devient un plateau de service



	cm	↑ cm	Farbe / Colour	€
13380	32 x 21,5	2	aluminium	10,60
13381 <small>NEW</small>	37 x 26,5	2	aluminium	12,00

VINTAGE



Tablett „VINTAGE“

tray
bandeja
plateau

Vintage-Look



	cm	↑ cm	€
30130	26,0 x 13,5	1,5	8,00
30131	34,0 x 18,0	1,5	13,20
30132	38,0 x 26,5	1,5	21,00
30133	25,5 x 16,0	3,0	16,00
30134	32,5 x 21,5	2,0	16,40

passende Schälchen / fitting bowls / cuencos adecuados / bols apropiés



	Ø cm	↑ cm	ltr.	€
40655	7,5	5,5	0,17	3,20
40656	7,5	10,0	0,35	4,00

Wachspapier / greaseproof paper squares / papel alimenticio / papier alimentaire

	cm	pcs.	Motiv:	€
40670	42 x 25	500	Motiv: Zeitung	59,00



Präsentationsmöglichkeit
presentation example

TRAYS STAINLESS STEEL



Serviertablett „KAFFEEHAUS“

tray
bandeja
plateau

hochglanzpoliert, stabiler Rand eingerollt
mirror polished, stable edge rolled in
pulido brillante, borde estable enrollado
poli brillant, bord stable enroulé



	cm	↑ cm	€
30148	Ø 27	1,5	6,00
30149	30 x 15,5	1,5	6,80

passende Hauben / cover / campana / cloche



	cm	↑ cm	suitable for	€
11055	Ø 23	12	30148	5,70
11056	26 x 12	10	30149	7,90



Präsentationsmöglichkeit
presentation example



Serviertablett „KAFFEEHAUS“

tray
bandeja
plateau

matt poliert, oval, Rand eingerollt
matt polished, oval, rolled edge
pulido mate, oval, borde enrollado
poli mat, ovale, bord enroulé



	cm	↑ cm	€
30111	20,0 x 14,5	0,5	für Zucker und Sahne / for sugar and cream 4,70
30112	26,5 x 19,5	0,5	für eine Tasse / for one cup 7,00
30113	29,0 x 22,0	0,5	für zwei Tassen / for two cups 7,50



Serviertablett „KAFFEEHAUS“

tray
bandeja
plateau

hochglanzpoliert, oval, Rand eingerollt
mirror polished, oval, rolled edge
pulido brillante, ovalado, borde enrollado
poli brillant, ovale, bord enroulé



	cm	↑ cm	€
30115	20,0 x 14,5	0,5	für Zucker und Sahne / for sugar and cream 4,70 para azúcar y crema / pour le sucre et la crème
30116	26,5 x 19,5	0,5	für eine Tasse / for one cup 7,00 para una taza / pour une tasse
30117	29,0 x 22,0	0,5	für zwei Tassen / for two cups 7,50 para dos tazas / pour deux tasses



Serviertablett „KAFFEEHAUS“

tray
bandeja
plateau

matt poliert, Rand eingerollt

matt polished, rolled edge
pulido mate, borde enrollado
poli mat, bord enrollé



	cm	↑ cm	€
30118	21,5 x 13	1,5	7,90
30119	23,0 x 23	1,5	10,90



30119

Präsentationsmöglichkeit
presentation example



84253

Serviertablett „KAFFEEHAUS“

tray
bandeja
plateau



	cm	↑ cm	€
84251	26,0 x 20,0	1,5	5,20
84253	28,5 x 21,5	1,5	5,80



Serviertablett „KAFFEEHAUS“

tray
bandeja
plateau

Innenfläche ziseliert, Rand eingerollt

chiselled inner surface, rolled edge
superficie interior cincelada, borde enrollado
surface intérieure ciselée, bord enrollé



	cm	↑ cm	VE / unit	€ / pc.
30114	30 x 22	1	48	3,00

TRAYS



Tablett mit Haube „ELEGANCE“

tray with cover
bandeja con campana
plateau avec cloche

2-teilig: Tablett aus Edelstahl + Haube

2 pcs.: stainless steel tray + cover
set de 2: bandeja de acero inoxidable + campana
set de 2: plateau en acier inox + cloche



	cm	↑ cm	€
00064	33 x 17	10	10,20
00067	25 x 19	7	9,40

Haube für 00064 / cover for 00064 / campana para 00064 / cloche pour 00064

	€
06401	4,00

Haube für 00067 / cover for 00067 / campana para 00067 / cloche pour 00067

	€
06701	3,00



Tortenplatte

cake plate
bandeja tartas
plat à gâteau

2-teilig: Tablett aus Edelstahl + Haube

2 pcs.: stainless steel tray + cover
set de 2: bandeja de acero inoxidable + campana
set de 2: plateau en acier inox + cloche



	Ø cm	↑ cm		€
00065	30	11	mit 1 Haube / with 1 cover	9,60
00652	30	7 + 11	mit 2 Hauben / with 2 cover	12,40



Tortenplatte „BAROCK“

cake plate
bandeja tartas
plat à gâteau

2-teilig: Tortenplatte mit Barock-Rand + Haube

2 pcs.: cake plate with decor edge „Barock“ + cover
set de 2: porta tartas, borde decor „Barock“ + campana
set de 2: plateau bord décor „Barock“ + cloche



	Ø cm	↑ cm	€
06503	32	12	13,20

Frischhaltehaube / cover / campana / cloche

	Ø cm	↑ cm	€
06510	30	11,5	5,90



Tablett mit Haube „FINESSE“

tray with cover
bandeja con campana
plateau avec cloche

2-teilig: Tablett aus Edelstahl + Haube

2 pcs.: stainless steel tray + cover
set de 2: bandeja de acero inoxidable + campana
set de 2: plateau en acier inox + cloche



	cm	↑ cm	€
13122	42 x 31	8,5	22,00



Tablett mit Haube „FINESSE“

tray with cover
bandeja con campana
plateau avec cloche

2-teilig: Tablett aus Edelstahl + Haube

2 pcs.: stainless steel tray + cover
set de 2: bandeja de acero inoxidable + campana
set de 2: plateau en acier inox + cloche



	Ø cm	↑ cm	€
13622	22	9,5	8,60



Tablett mit Haube „FINESSE“

tray with cover
bandeja con campana
plateau avec cloche

2-teilig: Tablett aus Edelstahl + Haube

2 pcs.: stainless steel tray + cover
set de 2: bandeja de acero inoxidable + campana
set de 2: plateau en acier inox + cloche



	Ø cm	↑ cm	Ø cm Hauben / cover	€
13382	38	12	30	22,40
13385	38	13	33	23,60



Frischhaltehaube

cover
campana
cloche

glasklar, schwere stabile Ausführung, stapelbar / clear, heavy stable quality, stackable / transparente, alta estabilidad, apilable / transparente, très stable, empilable



	Ø cm	↑ cm	€
06510	30	11,5	5,90
06515	33	12,5	7,50



Frischhaltehaube

cover
campana
cloche

glasklar, schwere stabile Ausführung, stapelbar / clear, heavy stable quality, stackable / transparente, alta estabilidad, apilable / transparente, très stable, empilable



	Ø cm	↑ cm	€
06512	30	11,5	8,20
06517	33	12,5	9,60

TRAYS



Tablett mit Haube, 2 teilig

tray with cover, 2 pcs.
bandeja con campana, set de 2
plateau avec cloche, set de 2

Tablett aus Bambus, ölimprägniert + Haube

bamboo tray, oil-impregnated + cover
bandeja de bambú, impregnada de aceite + campana
plateau en bambou, imprégné d'huile + cloche



	Ø cm	↑ cm	€
00822	20,5	10	8,60



Tablett mit Haube, 2-teilig

tray with cover, 2 pcs.
bandeja con campana, set de 2
plateau avec cloche, set de 2

Tablett aus Bambus, ölimprägniert + Haube

bamboo tray, oil-impregnated + cover
bandeja de bambú, impregnada de aceite + campana
plateau en bambou, imprégné d'huile + cloche



	Ø cm	↑ cm	€
00825	25	13,5	11,00



Tablett mit Haube, 2-teilig

tray with cover, 2 pcs.
bandeja con campana, set de 2
plateau avec cloche, set de 2

Tablett aus Bambus, ölimprägniert + Haube

bamboo tray, oil-impregnated + cover
bandeja de bambú, impregnada de aceite + campana
plateau en bambou, imprégné d'huile + cloche



	cm	↑ cm	€
00826	28 x 14	11,5	9,80



Tablett mit Haube, 2 teilig

tray with cover, 2 pcs.
bandeja con campana, set de 2
plateau avec cloche, set de 2

Tablett aus Bambus, ölimprägniert + Haube

bamboo tray, oil-impregnated + cover
bandeja de bambú, impregnada de aceite + campana
plateau en bambou, imprégné d'huile + cloche



	cm	↑ cm	€
00820	24 x 18,5	8	7,40
00821	32 x 16,5	11	9,80

2 tlg.
2 pcs.

Ø 38 cm / 50 cm

Rolltop-Setrolltop set
set rolltop
set cloche à fromage**2-teilig: Tablett + Rolltophaube glasklar, rutschfeste Haubenfixierung, klappbar**

2 pcs.: tray + rolltop cover, cover non-slip fixed, mountable

set de 2: bandeja + campana abatible fijación antideslizante, montable

set de 2: plateau + cloche abattante, fixation antidérapants, montable

	Ø cm	↑ cm	€
09080	38	24	39,00
09099	50	28	84,00

3 tlg.
3 pcs.**Rolltop-Set, 3-teilig**rolltop set, 3 pcs.
rolltop, set de 3
rolltop, set de 3**1 Edelstahltablett Ø 38 cm + 1 Naturschieferplatte Ø 33 cm + 1 Rolltophaube Ø 38 cm**

1 stainless tray Ø 38 cm + 1 natural slate tray Ø 33 cm + 1 rolltop cover Ø 38 cm

1 bandeja de acero inoxidable Ø 38 cm + 1 bandeja de pizarra natural Ø 33 cm

+ 1 tapa abatible Ø 38 cm

1 plat inox Ø 38 cm + 1 plat ardoise naturelle Ø 33 cm + 1 cloche Ø 38 cm

	Ø cm	↑ cm	€
01000	38	24	48,50

4 tlg.
4 pcs.**Kaviarkühler**caviar cooler
enfriador de caviar
rafraîchisseur de caviar**4-teilig: 1 Edelstahlschale, 1 Halter, 1 Glasschale, 1 Edelstahldeckel**

4 pcs.: 1 stainless steel bowl, 1 holder, 1 glass bowl Ø 10 cm, 1 stainless steel cover

set de 4: 1 bol de acero inoxidable, 1 soporte, 1 bol de vidrio Ø 10 cm, 1 tapa de acero inoxidable

set de 4: 1 bol en acier inox, 1 support, 1 bol en verre Ø 10 cm, 1 couvercle en acier inox

	Ø cm	↑ cm	€
01699	18	12	56,00

TRAYS



Partyplatte
partytray
bandeja party
plateau party
Rand eingerollt
rolled edge
borde enrollado
bord enroulé

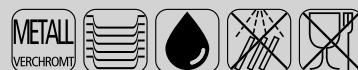

	cm	↑ cm	GN		VE / unit	€ / pc.
00396	Ø 35	1,5	-	round	24	5,20
00398	46,0 x 34,0	1,5	-	oval	24	5,20
00399	41,0 x 31,0	1,5	-		24	5,20
00389	35,4 x 32,5	1,5	2/3		24	5,00
00395	53,0 x 32,5	1,5	1/1		24	8,20



Partyplatte
partytray
bandeja party
plateau party
Rand eingerollt
rolled edge
borde enrollado
bord enroulé



	cm	↑ cm		VE / unit	€ / pc.
00393	Ø 35	1,5	round	24	5,20
00391	46 x 34	1,5	oval	24	5,20

	cm	↑ cm	GN	VE / unit	€ / pc.
00392	41 x 31,0	1,5	-	24	5,20
00394	53 x 32,5	1,5	1/1	24	8,20



Präsentationsmöglichkeit
presentation example



FAST FOOD

Tablett „FAST FOOD“ tray bandeja plateau



00535



00536



00537



00538



00534



00539

	cm	↑ cm	GN	Farbe / Colour	VE / unit	€ / pc.
00530	35 x 27,0	2			6	3,50
00535	41 x 30,5	2			6	4,70
00540	45 x 35,5	2			6	5,90
00552	53 x 32,5	2	1/1		6	7,20

	cm	↑ cm	GN	Farbe / Colour	VE / unit	€ / pc.
00531	35 x 27,0	2			6	3,50
00536	41 x 30,5	2			6	4,70
00541	45 x 35,5	2			6	5,90
00553	53 x 32,5	2	1/1		6	7,20

	cm	↑ cm	GN	Farbe / Colour	VE / unit	€ / pc.
00532	35 x 27,0	2			6	3,50
00537	41 x 30,5	2			6	4,70
00542	45 x 35,5	2			6	5,90
00554	53 x 32,5	2	1/1		6	7,20

	cm	↑ cm	GN	Farbe / Colour	VE / unit	€ / pc.
00533	35 x 27,0	2			6	3,50
00538	41 x 30,5	2			6	4,70
00543	45 x 35,5	2			6	5,90
00555	53 x 32,5	2	1/1		6	7,20

	cm	↑ cm	GN	Farbe / Colour	VE / unit	€ / pc.
00534	35 x 27,0	2			6	3,50

	cm	↑ cm	GN	Farbe / Colour	VE / unit	€ / pc.
00539	35 x 27,0	2			6	3,50



stapelbar
stackable

Präsentationsmöglichkeit
presentation example

NON-SLIP TRAYS



Serviertablett „NOSLIDE“

tray
bandeja
plateau



rutschfeste Oberfläche / non-slip surface / superficie anti-deslizante / surface antidérapante

	cm	↑ cm	GN	€
00516	53 x 32,5	2,5	1/1	13,00
00517	53 x 36,5	2,0		16,00



Tablett „NOSLIDE“

tray
bandeja
plateau



rutschfeste Oberfläche / non-slip surface / superficie antideslizante / surface antidérapante

	Ø cm	↑ cm	€
00547	27,5	2	7,60
00548	35,5	2	9,60
00549	40,5	2	11,40



Tablett „BISTRO“

tray
bandeja
plateau



rutschfest, mit 2 Griffmulden und Stapelrand

non-slip, two open handles, stackable edge
antideslizante, con 2 asas y borde apilable
antidérapant, avec 2 poignées et bord d'empilage

	Ø cm	↑ cm	€
84045	35,5	4,5	26,00



Serviertablett „GRIPZONE“

tray non-slip
bandeja
plateau



rutschfeste Oberfläche / non-slip surface / superficie antideslizante / surface antidérapante

	cm	↑ cm	GN	€
00502	53,0 x 32,5	1,5	1/1	27,00
00508	46,0 x 36,0	2,0		24,80



Bierglasträger „GRIPZONE“

beer rack
bandeja para cerveza
porte verre à bière



rutschfeste Oberfläche / non-slip surface / superficie antideslizante / surface antidérapante

	Ø cm	↑ cm	€
00500	36	3,5	23,00
00506	28 x 20	1,5	10,40



Serviertablett „HAPPY HOUR“

tray
bandeja
plateau



rutschfeste Oberfläche / non-slip surface / superficie antideslizante / surface antidérapante

	Ø cm	↑ cm	€
00510	32	1,5	23,00
00511	38	1,5	28,00
00515	43	1,5	32,00

CAKE STANDS



Servier- und Tortenplatte „ACACIA“
 cake stand
 porta pasteles
 présentoir à gâteaux



Akazienholz geölt, möbelschonende Unterseite
 acacia wood oiled, furniture-friendly underside
 madera de acacia aceitada, con base anti rayaduras
 bois d'acacia huilé, avec revêtement antirayures

	∅ cm	↑ cm	€
33292	24,0	8	53,00
33293	24,0	16	68,00
33294	33,0	8	74,00
33295	33,0	16	100,00
33296	38,5	8	90,00
33297	38,5	16	116,00



Frischhaltehaube „DOME“ / cover / campana / cloche



	∅ cm	↑ cm	fits to	€
06519	21	17	33292, 33293	30,00
06520	30	22	33294, 33295	37,00
06521	36	27	33296, 33297	74,00

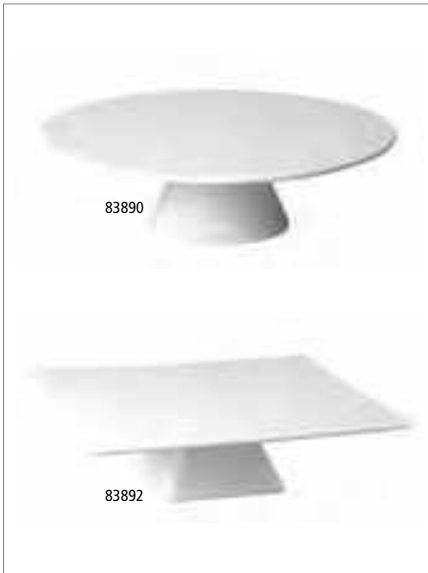

Servier- und Tortenplatte „CASUAL“

cake plate
porta pasteles
présentoir à gâteaux



	∅ cm	↑ cm	€
83890	31	8	28,60
83891	31	16	36,00

	cm	↑ cm	€
83892	31 x 31	8	32,00
83893	31 x 31	16	39,00



Servier- und Tortenplatte

cake stand
porta pasteles
présentoir à gâteaux



Rand fixiert die Haube, mit Antirutschfüßchen
carved edge fixes the cover, with non-slip feet
ranura para fijar bien la campana, con pies antideslizantes
bord rainuré pour maintenir ferme la cloche, avec pieds antidérapants

	∅ cm	↑ cm	Farbe / Colour	fits to cover	€
00468	31	3,5	White	06520	18,40
00469	31	3,5	Black	06520	18,40



drehbar
rotating

Servier- und Tortenplatte

cake stand
porta pasteles
présentoir à gâteaux



matt poliert, drehbar, möbelschonende Unterseite
matt polished, rotating, furniture-friendly underside
pulido mate, giratoria, con base anti rayaduras
poli mat, pivotant, avec revêtement antirayures

	∅ cm	↑ cm	€
00463	30,5	9	47,00



Servier- und Tortenplatte

cake stand
porta pasteles
présentoir à gâteaux



matt poliert / matt polished / pulido mate / poli mat

	∅ cm	↑ cm	€
00046	31	3	16,00

SUPER DOME



Frischhaltehaube „SUPER DOME“

cover
campana
cloche



schwere, glasklare Qualität
stable, crystal clear quality
muy resistente y transparencia cristalina
haute résistance et transparence

	Ø cm	↑ cm	€
06525	30	40	74,00

passende Servier-/Tortenplatten / suitable cake stands / porta pasteles compatibles /
présentoirs à gâteaux compatibles

	Ø cm	↑ cm	Farbe / Colour	€
00468	31	3,5		18,40
33294	33	8,0		74,00
33295	33	16,0		100,00

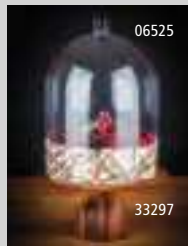

Präsentationsmöglichkeiten
presentation examples



Frischhaltehaube „DOME“

cover
campana
cloche



schwere, glasklare Qualität
stable, crystal clear quality
calidad estable y transparencia cristalina
qualité stable et clarté cristalline

	Ø cm	↑ cm	fits to	€
06519	21	17		30,00
06520	30	22	46, 463, 468, 469, 975, 998, 83884, 83890, 83891, 84177	37,00
06521	36	27		74,00

ACACIA



00794 1,8 ltr.



00795 2,5 ltr.



00796 3,0 ltr.

Schale „ACACIA“

bowl
cuenco
bol

aus geöltem Akazienholz
made of oiled acacia wood
de madera de acacia aceitada
en bois d'acacia huilé



	Ø cm	↑ cm	ltr.	€
00794	21	8,5	1,8	38,00
00795	25	8,5	2,5	43,00
00796	27	8,5	3,0	48,00



3 Größen ineinander
3 sizes in each other



33269

Buffetständer „MULTI ROUND“

buffet stand
soporte para buffet
présentoir buffet

Metall, mit schwarzer Antirutschbeschichtung
metal, with black anti-slide coating
metal, con revestimiento antideslizante negro
métal, avec revêtement antidérapant noir



	Ø cm	↑ cm	€
33269	15,5 / 18	8	10,90
33270	15,5 / 18	10	13,00
33271	15,5 / 18	18	16,70

SIMPLY WOOD

**Servierbrett „SIMPLY WOOD“**

serving board
tabla de servir
planche de service



Eichenholz geölt, mit Aufhängeloch Ø 1,5 cm, mit Lederband

oak wood oiled, with handle hole Ø 1,5 cm, with leather strap
madera de roble aceitada, con agujero para colgar Ø 1,5 cm, con correa de cuero
bois de chêne huilé, avec trou de suspension Ø 1,5 cm, avec ruban en cuir

	cm	↑ cm	→ Griff / handle	€
00751	27 x 17	2	8	32,00
00752	32 x 22	2	8	42,00

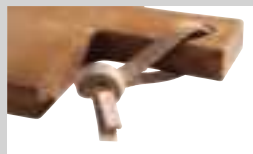

mit Lederband
with leather strap

**Tablett / Sushiboard „SIMPLY WOOD“**

tray / sushiboard
bandeja para sushi
plateau sushi



aus geöltem Eichenholz
made of oiled oak wood
de madera de roble aceitada
en bois de chêne huilé

	cm	↑ cm	€
00753	35 x 17	2	23,80

**GN 1/3 Servierbrett „SIMPLY WOOD“**

GN 1/3 serving board
GN 1/3 tabla de servir
GN 1/3 planche de service



Eichenholz geölt, mit Aussparung Ø 4 cm, mit Safrinne

oak wood oiled, with notch Ø 4 cm, with juice groove
madera de roble aceitada, con ranura Ø 4 cm, con ranura para líquidos
bois de chêne huilé, mit avec encoche Ø 4 cm, avec rigole

	cm	↑ cm	GN	€
00754	32,5 x 17,6	2	1/3	23,80

NEW

**Serviertablett „VALO“**tray
bandeja
plateau**Eichenholz (geölt), Innenmaß 56 x 36 cm**

oak wood (oiled), inside dimensions 56 x 36 cm

madera de roble (aceitada), dimensiones interiores 56 x 36 cm

bois du chêne (huilé), dimensions intérieures 56 x 36 cm

	cm	↑ cm	fits to	€
14060	60 x 40	3	14061	82,00

NEW

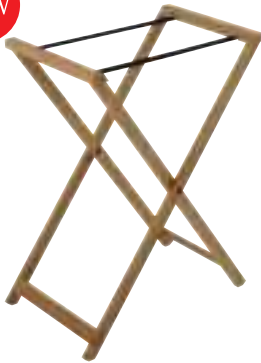
**Tablettständer „VALO“**tray stand
soporte para bandejas
support de plateau**Eichenholz (geölt), zusammenklappbar**

oak wood (oiled), collapsible

madera de roble (aceitada), plegable

bois du chêne (huilé), pliable

	cm	↑ cm	fits to	€
14061	56 x 35,5	75	14060	130,00

Ø 9,5 cm

40601

**Servierbrett „OAK“**serving board
tabla de servir
planche de service**aus geöltem Eichenholz, Safrille, Ø 9,5 cm Aussparung**

made of oiled oak, with juice groove, with hole Ø 9.5 cm

de madera de roble aceitada, con ranura para líquidos, con agujero Ø 9,5 cm

en bois chêne huilé, avec rigole, avec trou Ø 9,5 cm

	cm	↑ cm	€
00808	37 x 25	2	31,00

Servierbrett „PIZZA“serving board
tabla de servir
planche de service**Eichenholz geölt, mit Safrinne, mit 2 Griffmulden**

oak wood oiled, with juice groove, with 2 recessed handles

madera de roble aceitada, con ranura para líquidos, con 2 asas empotradas

bois de chêne huilé, avec rigole, avec 2 poignées encastrées

	Ø cm	↑ cm	€
00757	34	2	32,00

Serviertablettserving tray
bandeja para servir
plateau de service**aus geöltem Eichenholz, mit 2 Griffmulden**

made of oiled oak wood, with 2 recessed handles

de madera de roble aceitada, con 2 asas empotradas

en bois de chêne huilé, avec 2 poignées encastrées

	cm	↑ cm	€
00761	45 x 35	6	48,00



SERVING BOARDS



Servierbrett „VELVET“

serving board
tabla de servir
planche de service

Servierbrett aus geöltem Akazienholz
serving board made of oiled acacia wood
tabla de servir de madera de acacia aceitada
planche en bois avec plateau en bois d'acacia huilé



	cm	↑ cm	€
00897	30 x 15	2	14,20
00898	30 x 18	2	16,50
00899	35 x 25	2	23,00



Servierbrett

serving board
tabla de servir
planche de service

aus geöltem Akazienholz
made of oiled acacia wood
de madera de acacia aceitada
en bois d'acacia huilé



	cm	↑ cm	€
00793	25 x 17	1,5	13,00



Servierbrett

serving board
tabla de servir
planche de service

aus geöltem Akazienholz
made of oiled acacia wood
de madera de acacia aceitada
en bois d'acacia huilé



	cm	↑ cm	€
00792	37 x 8	2	10,80

2 tlg.
2 pcs.

Servierbrett „FUSIONA“

serving board
tabla de servir
planche de service



2-teilig: 1 Holzbrett aus Akazienholz + 1 Naturschieferplatte

2 pcs.: 1 wood board made of acacia wood + 1 natural slate tray

set de 2: 1 tabla de madera de acacia + 1 pizarra natural

set de 2: 1 planche en bois d'acacia + 1 ardoise naturelle

	cm	↑ cm	€
00814	28 x 17,5	2	16,00



mit Aussparung ø 5 cm
with hole ø 5 cm

2 tlg.
2 pcs.

00810



00811



00812



00813

Servierbrett „FUSIONA“

serving board
tabla de servir
planche de service



2-teilig: 1 Holzbrett aus Akazienholz + 1 Naturschieferplatte

2 pcs.: 1 wood board made of acacia wood + 1 natural slate tray

set de 2: 1 tabla de madera de acacia + 1 pizarra natural

set de 2: 1 planche en bois d'acacia + 1 ardoise naturelle

	cm	↑ cm	Griff / handle cm	€
00810	26 x 18	2	8	15,00
00811	33 x 20	2	8	18,40
00812	40 x 15	2	5	23,40
00813	43 x 12	2	12	19,00

Präsentationsmöglichkeit
presentation example



00813

mit Hängeloch Ø 2 cm / with a handle-hole Ø 2 cm

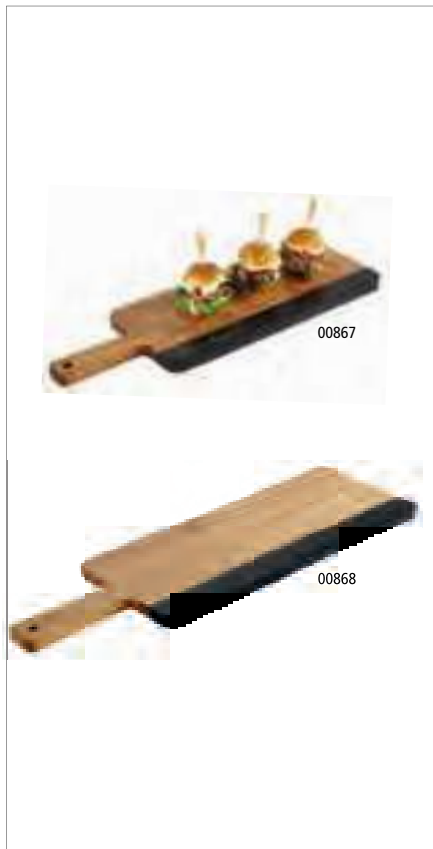

Servierbrett „ROCKWOOD“

serving board
 tabla de servir
 planche de service



geeignet zur Beschriftung, mit Hängeloch Ø 1 cm

suitable for labeling, with hanging hole Ø 1 cm

apto para rotulación, con orificio para colgar Ø 1 cm

adapté pour l'étiquetage, avec trou de suspension Ø 1 cm

	cm	↑ cm	Griff / handle cm	€
00867	30,5 x 13	1,5	10	18,60
00868	36,5 x 15	1,5	12	23,60
00869	42,0 x 18	1,5	14	26,80



Kreide-Marker, Stärke 2 mm, 2er Set

chalk marker, 2 pcs.

rotulador de tiza, set de 2

marqueur a la craie liquide, set de 2



Zum Gestalten und Beschriften von Tafeln, Glas und fast allen geschlossenen Oberflächen, deckende Flüssigkreide auf Wasserbasis, feucht abwischbar

For decorating and writing on boards, glass and almost all non-porous surfaces, opaque water-based liquid chalk, wet-wipeable

Rotuladores para pizarra de tiza líquida para decorar y escribir sobre pizarras, cristales y casi todas las superficies no porosas. Tiza líquida opaca al agua que se pueda borrar con un trapo

Pour décorations et inscriptions sur tableaux, verre et presque toutes les surfaces non poreuses, craie liquide opaque à base d'eau, effaçable avec un chiffon humide

	Ø cm	↑ cm	Farbe / Colour	pcs.	€ / set
71490	1	13	white	2	6,20



Servierbrett „SHARING“

serving board
 tabla de servir
 planche de service



Servierbrett aus geöltem Akazienholz

serving board made of oiled acacia wood

tabla de servir de madera de acacia aceitada

planche en bois d'acacia huilé

	cm	↑ cm	Griff / handle cm	€
00887	51,5 x 18	1,5	8,5	34,00



00905



00906

Servierbrett „OLIVE“

serving board
 tabla de servir
 planche de service



aus geöltem Olivenholz, naturbedingte Abweichung in Form,
 Maserung und Größe

oiled olive wood, natural deviation in shape, grain and size
 de madera de olivo aceitada, diferencias naturales posibles en
 forma, grano y tamaño

en bois d'olivier huilé, éventuelles différences naturelles de forme,
 de grain et de taille

	cm	↑ cm	€
00905	25,5 x 16,5	1,5	12,00
00906	35,0 x 20,5	1,5	22,00



00870



00871



00876



00877



00873



00874

Servierbrett „OLIVE“

serving board
 tabla de servir en madera de olivo
 planche de service en bois d'olivier



aus geöltem Olivenholz, naturbedingte Abweichung in Form,
 Maserung und Größe, mit Hängeloch Ø 2 cm

oiled olive wood, natural deviation in shape, grain and size, with hanging hole Ø 2 cm

de madera de olivo aceitada, diferencias naturales posibles en forma, grano y tamaño, con
 orificio para colgar Ø 2 cm

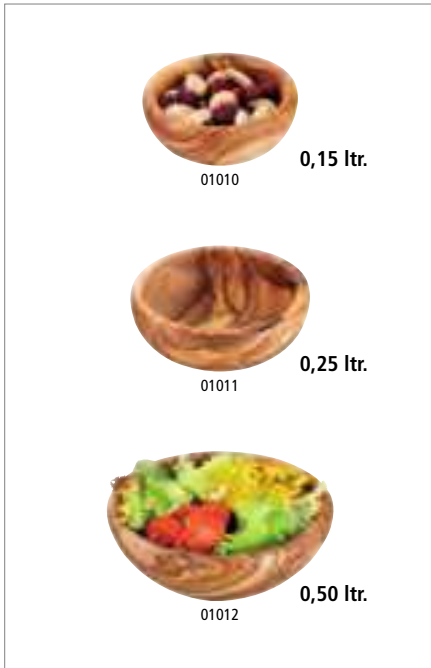

en bois d'olivier huilé, éventuelles différences naturelles de forme, de grain et de taille, avec
 trou de suspension Ø 2 cm

	cm	↑ cm	Griff / handle cm	€
00870	25 x 17,0	1,5		32,00
00871	30 x 20,5	2,0		52,00
00873	40 x 15,0	1,5	11	56,00
00874	44 x 20,0	2,0	12	72,00
00876	25 x 16,0	1,5	8	35,00
00877	31 x 20,0	1,5	9	52,00



Schale „OLIVE“
bowl
cuenco
bol

aus geöltem Olivenholz, naturbedingte Abweichung in Form, Maserung und Größe
oiled olive wood, natural deviation in shape, grain and size
de madera de olivo aceitada, diferencias naturales posibles en forma, grano y tamaño
en bois d'olivier huilé, éventuelles différences naturelles de forme, de grain et de taille

HOLZ WOOD   

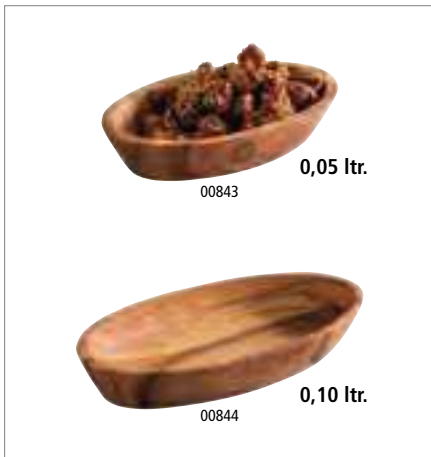

	Ø cm	↑ cm	litr.	€
01010	10,0	4,0	0,15	10,00
01011	12,5	4,5	0,25	13,80
01012	15,0	6,0	0,50	20,00

 **3 Größen ineinander**
3 sizes in each other



Schale „OLIVE“
bowl
cuenco
bol

aus geöltem Olivenholz, naturbedingte Abweichung in Form, Maserung und Größe
oiled olive wood, natural deviation in shape, grain and size
de madera de olivo aceitada, diferencias naturales posibles en forma, grano y tamaño
en bois d'olivier huilé, éventuelles différences naturelles de forme, de grain et de taille

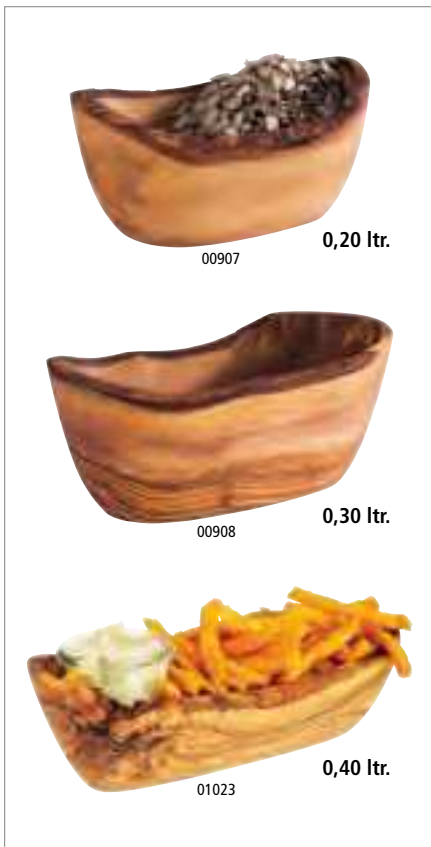

HOLZ WOOD   

	cm	↑ cm	litr.	€
00843	12,0 x 7,5	2,5	0,05	7,80
00844	16,5 x 9,5	2,5	0,10	10,00



Schale „OLIVE“
bowl
cuenco
bol

aus geöltem Olivenholz, naturbedingte Abweichung in Form, Maserung und Größe
oiled olive wood, natural deviation in shape, grain and size
de madera de olivo aceitada, diferencias naturales posibles en forma, grano y tamaño
en bois d'olivier huilé, éventuelles différences naturelles de forme, de grain et de taille

HOLZ WOOD  

	cm	↑ cm	litr.	€
00907	13,0 x 8,0	6,5	0,2	6,60
00908	16,0 x 9,0	7,0	0,3	10,00
01023	25,0 x 8,5	7,5	0,4	18,00

**Table Caddy „OLIVE“**

table barrel
caddy de mesa
caddy de table

aus geöltem Olivenholz

oiled olive wood

de madera de olivo aceitada

en bois d'olivier huilé



	cm	↑ cm	€
01016	22 x 15	6	21,00
01017	25 x 18	6	29,00



Allzweckstreuer, 12 er Set / shaker, 12 pcs. / dosificador, set de 12 / salières/poivrières set de 12

	cm	↑ cm	ltr.	€ / set
40504	4 x 4	10	0,07	23,40

passende Brottasche / suitable bread basket / panera a juego / corbeilla assortie

	cm	↑ cm	Farbe / Colour	€
30356	12 x 11,5	11,5	■	6,80

passende Mühlen / suitable mills/ molinos de ajuste / moulins assortis

	ø cm	↑ cm	€
40555	6	15,5	33,20
40556	6	15,5	33,20

**Wachspapier „SNACKHOLDER“**

greaseproof paper squares

papel alimenticio

papier alimentaire



	cm	pcs.	Motiv: Zeitung	€
40670	42 x 25	500	Motiv: Zeitung	59,00



Schale „OLIVE“

bowl
cuenco
bol



aus geöltem Olivenholz
oiled olive wood
de madera de olivo aceitada
en bois d'olivier huilé

	cm	↑ cm	ltr.	€
01013	7,5 x 7,5	2,5	0,05	5,00
01014	17,5 x 8,5	2,5	0,15	12,40
01015	26,5 x 11,5	5,0	0,60	19,00



Holzbox „TABLE“

woodbox
caja madera
base bois



Akazienholz, 3 Fächer (6,5 x 6,5 cm) / acacia wood, 3 compartments (6,5 x 6,5 cm) / madera de acacia, 3 compartimentos (6,5 x 6,5 cm) / bois d'acacia, 3 compartiments (6,5 x 6,5 cm)

	cm	↑ cm	inner size cm	€
11727	23,5 x 8,5	4,5	6,5 x 6,5 je Fach / each compartment	13,60

Servierbeispiel - Lieferung ohne Gläser
delivery without glasses



Servierbrett „NARROW I“

serving board
tabla de servir
planche de service



Akazienholz, mit 3 Vertiefungen Ø 4 cm / acacia wood, with 3 notches Ø 4 cm
madera de acacia, con 3 ranuras Ø 4 cm / bois d'acacia, avec 3 encoches Ø 4 cm

	cm	↑ cm	€
00864	22 x 8	1,5	10,60

passende Schälchen / fitting bowls / cuencos adecuados / bols appropriés

	Ø cm	↑ cm	ltr.	VE / unit	€ / pc.	
40685	6	3,0	0,05	stainless steel	24	2,40



Servierbrett „NARROW II“

serving board
tabla de servir
planche de service



Akazienholz, mit 3 Vertiefungen Ø 6 cm
acacia wood, with 3 notches Ø 6 cm
madera de acacia, con 3 ranuras Ø 6 cm
bois d'acacia, avec 3 encoches Ø 6 cm

	cm	↑ cm	€
00878	31 x 11	2,0	12,00

passende Schälchen / fitting bowls / cuencos adecuados / bols appropriés

	Ø cm	↑ cm	ltr.	VE / unit	€ / pc.	
40686	8	4,5	0,17	stainless steel	24	3,60

FRIENDLY



• hergestellt aus gebrauchtem Kunststoff – aus recyceltem Post-Consumer PET
 • recycelbar und umweltschonend

• made from used plastic – made of recycled post-consumer PET
 • recyclable and environmentally friendly

• fabricado de plástico usada: de PET reciclado postconsumo
 • reciclable y ecológico

• fabriqué de plastique usagée – composé à de PET recyclé post-consummation
 • recyclable et écologique



Schale „FRIENDLY“

bowl
 cuenco
 bol



	Ø cm	↑ cm	ltr.	Farbe / Colour	€
79042	14,5	9	0,4	—	5,90
79044	21,0	13	1,5	—	12,40
79046	24,5	15	2,5	—	16,00



Schale „FRIENDLY“
bowl
cuenco
bol



	cm	↑ cm	ltr.	Farbe / Colour	VE / unit	€ / pc.
79022	6,5 x 6,5	3,0	0,05	White	6	2,00
79023	6,5 x 6,5	3,0	0,05	Black	6	2,00
79000	9,0 x 9,0	4,0	0,14	White	–	4,20
79001	9,0 x 9,0	4,0	0,14	Black	–	4,20
79002	12,5 x 12,5	6,5	0,40	White	–	6,00
79003	12,5 x 12,5	6,5	0,40	Black	–	6,00
79004	19,0 x 19,0	9,0	1,50	White	–	15,00
79005	19,0 x 19,0	9,0	1,50	Black	–	15,00
79008	25,0 x 25,0	12,0	3,8	White	–	19,00
79009	25,0 x 25,0	12,0	3,8	Black	–	19,00



Deckel „PURE“ mit Löffelaussparung
cover with notched for spoons
tapa con espacio para la cuchara
couverture avec encoche pour la louche



	cm	↑ cm	fits to	€
83600	19 x 19	1,5	79004, 79005, 83409, 83468, 84244, 85260, 85266	8,20
83601	25 x 25	1,5	83469, 83408, 84245, 84561, 84562, 85261, 85267	10,40



Dipschälchen „FRIENDLY“
dip bowl
cuenco para dip
ramequin



	Ø cm	↑ cm	ltr.	Farbe / Colour	VE / unit	€ / pc.
79014	6	4	0,05	White	6	1,10
79015	6	4	0,05	Black	6	1,10



Schälchen „FRIENDLY“
mini bowl
mini cuenco
mini bol



	Ø cm	↑ cm	ltr.	Farbe / Colour	VE / unit	€ / pc.
79016	6,0	2,5	0,02	White	12	1,00
79017	6,0	2,5	0,02	Black	12	1,00
79018	7,5	3,5	0,05	White	12	2,00
79019	7,5	3,5	0,05	Black	12	2,00
79020	10,0	4,5	0,15	White	–	3,00
79021	10,0	4,5	0,15	Black	–	3,00



Schale „FRIENDLY“
bowl
cuenco
bol



	Ø cm	↑ cm	ltr.	Farbe / Colour	€
79024	14	6,5	0,5	White	4,00
79025	14	6,5	0,5	Black	4,00
79026	20	9,0	1,8	White	8,40
79027	20	9,0	1,8	Black	8,40
79028	23	10,5	2,5	White	9,50
79029	23	10,5	2,5	Black	9,50

FRIENDLY



79038 **0,05 ltr.**

79039 **0,06 ltr.**

79040 **0,04 ltr.**

79041 **0,07 ltr.**

Schale „FRIENDLY“ bowl cuenco bol



	cm	↑ cm	ltr.	Farbe / Colour	VE / unit	€/ pc.
79038	7,5 x 7,0	4,5	0,05	White	12	1,80
79039	11,5 x 7,5	3,0	0,06	White	12	1,80
79040	11,5 x 6,0	5,5	0,04	White	12	1,80
79041	8,5 x 7,0	6,0	0,07	White	12	1,80



79010

79011

Fingerfoodlöffel „FRIENDLY“ party spoon cuchara party cuillère party



	cm	↑ cm	Farbe / Colour	VE / unit	€/ pc.
79010	13,5 x 4,5	4,5	White	12	1,20
79011	13,5 x 4,5	4,5	Black	12	1,20

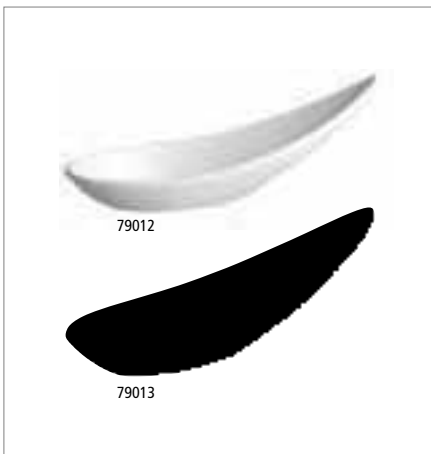

79012

79013

Fingerfoodlöffel „FRIENDLY“ party spoon cuchara party cuillère party



	cm	↑ cm	Farbe / Colour	VE / unit	€/ pc.
79012	11,0 x 4,5	4	White	12	1,20
79013	11,0 x 4,5	4	Black	12	1,20



GN Behälter „FRIENDLY“

GN pan
GN cubeta
GN bac

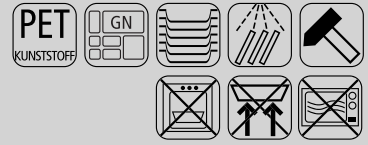

	cm	↑ cm	ltr.	Farbe / Colour	GN	€
79030	53 x 32,5	6,5	7,1		1/1	24,00
79031	53 x 32,5	6,5	7,1		1/1	24,00
79032	32,5 x 26,5	6,5	3,4		1/2	14,90
79033	32,5 x 26,5	6,5	3,4		1/2	14,90
79034	32,5 x 17,6	6,5	2,0		1/3	12,80
79035	32,5 x 17,6	6,5	2,0		1/3	12,80
79036	32,5 x 17,6	10,0	2,7		1/3	14,90
79037	32,5 x 17,6	10,0	2,7		1/3	14,90



GN Tablett „FRIENDLY“

GN tray
GN bandeja
GN plateau



	cm	↑ cm	Farbe / Colour	GN	€
79006	32,5 x 26,5	3		1/2	15,80
79007	32,5 x 26,5	3		1/2	15,80





Buffet & Tableware Melamine



AIKO	217	LA VIDA	230
ARABESQUE	206	LINEO	184
ASIA+	224	LOOPS	198
BALANCE	253	MARONE	214
BAMBOO	202	MEDITERRANEAN	230
BLUSH	182	MOON	193
BLUE OCEAN	208	NERO	186
CAKE PLATES	252	OAK	243
CANCUN	200	OAK LIGHT	238
CASUAL	254	PARTY SPOONS	262
CRAZY WOOD	202	PADELLA	221
CROCKER	222	PURE	244
DARK WAVE	218	SLATE	240
DIP BOWLS	255	SLATE ROCK	242
DRIFTWOOD	239	STONE ART	194
ELEMENT	228	ZERO	239
EGG HOLDERS	264	ZEN	210
EMMA	204		
ENAMEL LOOK	231		
FLOAT	248		
FOOTMARK	197		
FRIDA	232		
GLAMOUR	227		
GLOBAL BUFFET	250		
GN CONTAINERS	265		
HALFTONE	220		

NEW BLUSH



GN Tablett „BLUSH“

GN tray
GN bandeja
GN plateau



	cm	↑ cm	GN	€
85500	53,0 x 32,5	2,5	1/1	44,00
85501	32,5 x 26,5	2,5	1/2	23,00
85502	53,0 x 16,2	2,5	2/4	23,00



Teller „BLUSH“

plate
plato
assiette



	Ø cm	↑ cm	€
85503	21	3	9,90
85504	26	3	11,00
85505	33	3,5	17,00
85506	42	3,5	29,40



Teller „BLUSH“

plate
plato
assiette



	Ø cm	↑ cm	ltr.	€
85507	29	6	0,3	18,90



85508

85509

Schale „BLUSH“

bowl
cuenco
bol



	Ø cm	↑ cm	ltr.	€
85508	16	6,5	0,5	8,80
85509	19	8,0	0,9	13,00



85510

85511

Schale „BLUSH“

bowl
cuenco
bol



	Ø cm	↑ cm	ltr.	€
85510	22,5	4,5	0,8	13,20
85511	30,0	7,0	2,2	24,00





jeder Artikel ist ein Unikat
each item is unique

NEW LINEO



Dipschälchen, 6er Set „LINEO“
dip bowl, 6 pcs. set
cuenco para dip, set de 6
ramequin, set de 6



	Ø cm	↑ cm	ltr.	Farbe / Colour	pcs.	€/ set
85336	6	3,5	0,03	 white	6	17,00
85337	6	3,5	0,03	 grey	6	17,00
85338	6	3,5	0,03	 brown	6	17,00





85330



85331



85332

Schale, 6er Set „LINEO“

bowl
cuenco
bol



	Ø cm	↑ cm	ltr.	Farbe / Colour	pcs.	€ / set
85330	7	6,5	0,09	white	6	25,00
85331	7	6,5	0,09	grey	6	25,00
85332	7	6,5	0,09	brown	6	25,00



85333



85334



85335

Schale, 6er Set „LINEO“

bowl
cuenco
bol



	Ø cm	↑ cm	ltr.	Farbe / Colour	pcs.	€ / set
85333	8,5	7,5	0,18	white	6	37,00
85334	8,5	7,5	0,18	grey	6	37,00
85335	8,5	7,5	0,18	brown	6	37,00



NERO

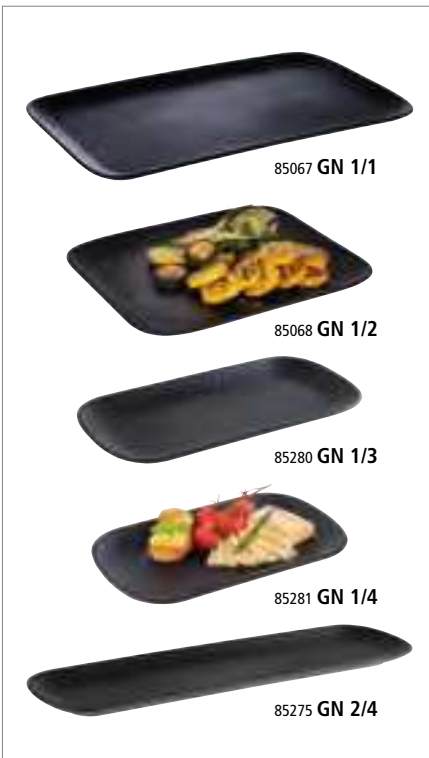

GN Tablett „NERO“

GN tray
GN bandeja
GN plateau



	cm	↑ cm	GN	€
85067	53,0 x 32,5	2,5	1/1	39,00
85068	32,5 x 26,5	2,5	1/2	21,00
85280 <small>NEW</small>	32,5 x 17,6	2,5	1/3	16,00
85281 <small>NEW</small>	26,5 x 16,2	2,5	1/4	13,00
85275	53,0 x 16,2	2,5	2/4	21,00

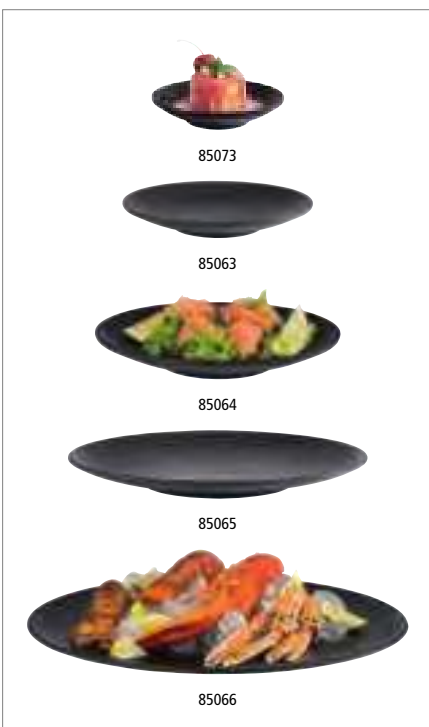

Teller „NERO“

plate
plato
assiette



	Ø cm	↑ cm	€
85073	15	3,0	6,00
85063	21	3,0	8,80
85064	26	3,0	9,80
85065	33	3,5	15,20
85066	42	3,5	26,00

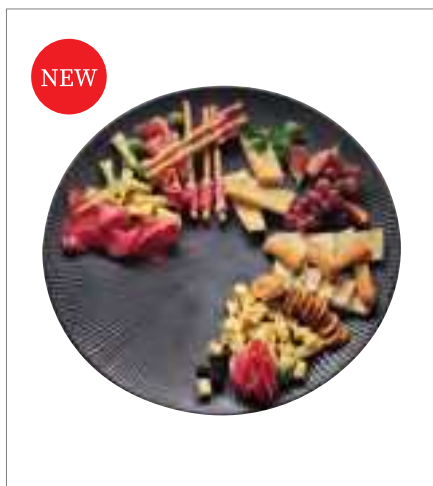

Servierplatte „NERO“

serving plate
plato de servir
plateau de service



	∅ cm	↑ cm	€
85283	50	3,5	44,00



Teller „NERO“

plate
plato
assiette



	∅ cm	↑ cm	ltr.	€
85098	29	6	0,3	16,80



Teller „NERO“

plate
plato
assiette



mit integriertem Dipschälchen
with integrated dip bowl
con cuenco para dip integrado
avec ramequin intégré

	cm	↑ cm	ltr.	€
85074	24 x 20	2,5	0,04	9,40
85075	30 x 25	2,5	0,06	12,40



Tablett „NERO“

tray
bandeja
plateau



mit 2 integrierten Dipschälchen / with 2 integrated dip bowls /
con 2 cuencos para dip integrados / avec 2 ramequins intégrés

	cm	↑ cm	ltr.	€
85097	41 x 15	2,5	2 x 0,03	18,80



Schale „NERO“

bowl
cuenco
bol



	∅ cm	↑ cm	ltr.	€
85069	16	6,5	0,5	7,80
85070	19	8,0	0,9	11,60
85061	24	9,0	1,7	16,40



Schale „NERO“
bowl
cuenco
bol

original
APS
melamine

MAX
70°C

Stacking icon

Washing icon

	∅ cm	↑ cm	ltr.	€
85060	22,5	4,5	0,8	11,80
85062	30,0	7,0	2,2	22,00

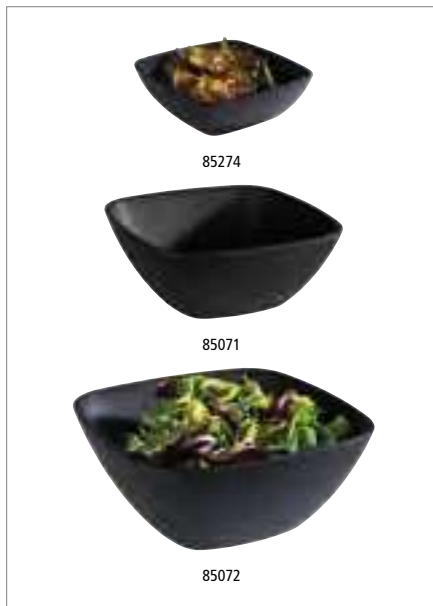

Schale „NERO“
bowl
cuenco
bol

original
APS
melamine

MAX
70°C

Stacking icon

Washing icon

	cm	↑ cm	ltr.	€
85274	16,5 x 16,5	5,5	0,6	9,00
85071	19,5 x 19,5	8	1,5	14,20
85072	25,0 x 25,0	11	3,5	23,40



Schale „NERO“
bowl
cuenco
bol

original
APS
melamine

MAX
70°C

Stacking icon

Washing icon

	cm	↑ cm	ltr.	€
85076	23 x 18	5	0,6	12,40
85077	28 x 22	7	0,8	18,80

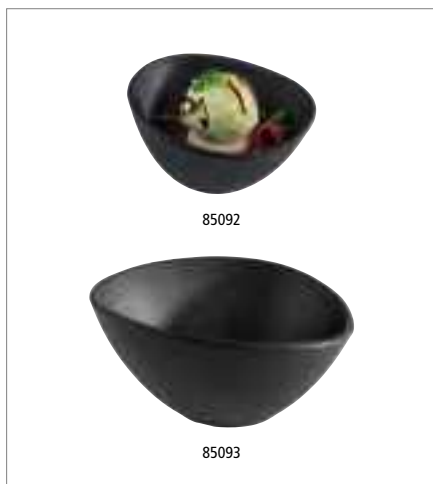

Schale „NERO“
bowl
cuenco
bol

original
APS
melamine

MAX
70°C

Stacking icon

Washing icon

	cm	↑ cm	ltr.	€
85092	14,5 x 12,5	8	0,3	7,60
85093	19,0 x 16,5	9	0,5	10,20



Schale „NERO“

bowl
cuenco
bol



	Ø cm	↑ cm	ltr.	€
85282 <small>NEW</small>	7,0	3,5	0,07	2,80
85270	8,5	3,5	0,10	3,50



Schale „NERO“

bowl
cuenco
bol



	Ø cm	↑ cm	ltr.	€
85271	12,5	4,5	0,25	7,80
85272	15,5	5,5	0,45	8,80
85273	20,5	7,5	1,20	13,00

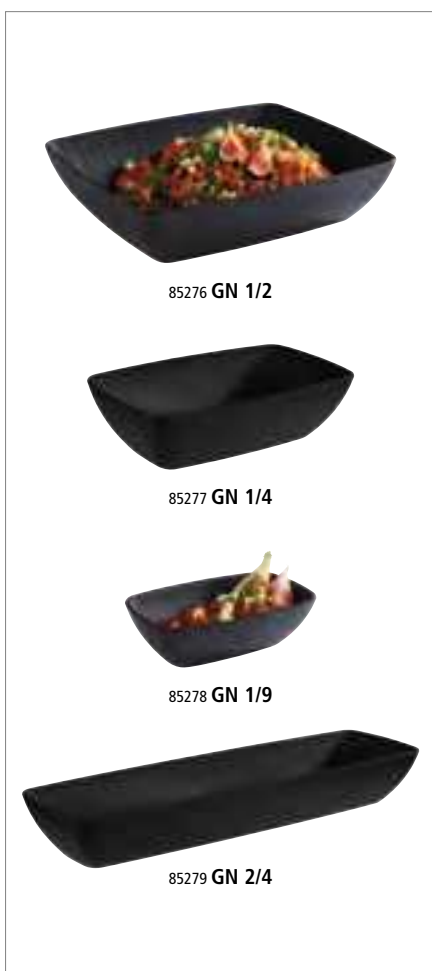

GN Schale „NERO“

GN bowl
GN cuenco
GN bol



	cm	↑ cm	ltr.	GN	€
85276	32,5 x 26,5	7,5	3,50	1/2	24,00
85277	26,5 x 16,2	7,5	1,50	1/4	18,00
85278	17,6 x 10,8	5,5	0,35	1/9	8,80
85279	53,0 x 16,2	7,5	3,50	2/4	27,00



NEW

NERO



85400 GN 1/1

85401 GN 1/2

85402 GN 2/4

GN Tablett „NERO“

GN tray
GN bandeja
GN plateau



MAX 70°C



	cm	↑ cm	GN	€
85400	53,0 x 32,5	2,5	1/1	37,50
85401	32,5 x 26,5	2,5	1/2	20,00
85402	53,0 x 16,2	2,5	2/4	21,00



85403

85404

85405

Teller „NERO“

plate
plato
assiette



MAX 70°C



	Ø cm	↑ cm	€
85403	21	3,0	8,20
85404	26	3,0	9,20
85405	33	3,5	14,20



Teller „NERO“

plate
plato
assiette



MAX 70°C



	Ø cm	↑ cm	ltr.	€
85406	29	6	0,3	16,80

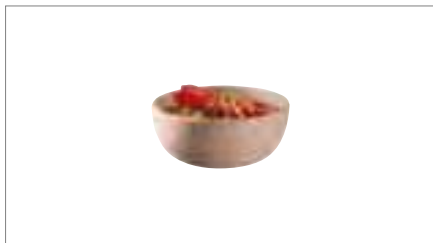

Schale „NERO“

bowl
cuenco
bol



	Ø cm	↑ cm	ltr.	€
85407	8,5	3,5	0,1	3,50



85408

85409

Schale „NERO“

bowl
cuenco
bol



	cm	↑ cm	ltr.	€
85408	14,5 x 12,5	8	0,3	7,00
85409	19,0 x 16,5	9	0,5	9,40



Schale „NERO“

bowl
cuenco
bol



	cm	↑ cm	ltr.	€
85410	23 x 18	5	0,6	12,40



85414

85415

Schale „NERO“

bowl
cuenco
bol



	Ø cm	↑ cm	ltr.	€
85414	22,5	4,5	0,8	11,80
85415	30,0	7,0	2,2	22,00



NERO



Schale „NERO“
bowl
cuenco
bol

original
APS
melamine

MAX
70°C

Stacking icon

Heat icon

	∅ cm	↑ cm	ltr.	€
85411	16	6,5	0,5	7,20
85412	19	8,0	0,9	10,80
85413	24	9,0	1,7	16,40



Schale „NERO“
bowl
cuenco
bol

original
APS
melamine

MAX
70°C

Stacking icon

Heat icon

	cm	↑ cm	ltr.	€
85416	19,5 x 19,5	8	1,5	14,20
85417	25,0 x 25,0	11	3,5	23,40



GN Schale „NERO“
GN bowl
GN cuenco
GN bol

original
APS
melamine

MAX
70°C

GN icon

Stacking icon

Heat icon

	cm	↑ cm	ltr.	GN	€
85418	32,5 x 26,5	7,5	3,5	1/2	24,00
85419	53,0 x 16,2	7,5	3,5	2/4	27,00



MOON



Servierset „MOON“, 6-teilig

serving set, 6 pcs.
set para servir, set de 6
set de service, set de 6

6-teiliges Set: 3 Schalen + 3 Holzlöffel (Nanmu)

6 pcs.: 3 bowls + 3 wooden spoons (Nanmu)

set de 6: 3 cuencos + 3 cucharas de madera (Nanmu)

set de 6: 3 bols + 3 cuillères en bois (Nanmu)



	Ø cm	↑ cm	ltr.	Farbe / Colour	€
85080	8	7,5	0,05		34,00
85081	8	7,5	0,05		34,00



Servierset „MOON“, 2-teilig

serving set, 2 pcs.
set para servir, set de 2
set de service, set de 2

2-teiliges Set: 1 Schale + 1 klappbarer Deckel

2 pcs.: 1 bowl + 1 hinged cover

set de 2: 1 cuenco + 1 tapa con bisagra

set de 2: 1 bol + 1 couvercle avec charnières



	Ø cm	↑ cm	ltr.	Farbe / Colour	€
85082	19	17,5	0,8		39,50
85083	19	17,5	0,8		39,50



klappbarer Deckel
hinged cover



Präsentationsmöglichkeit
presentation example



Löffel

spoon
cuchara
cuillère

Nanmu Holz / nanmu wood / madera de nanmu / bois de nanmu



	cm	→ cm	€
87027	3,5 x 3	10	3,00

STONE ART



84511

Teller „STONE ART“

plate
plato
assiette



	Ø cm	↑ cm		€
84510	19	2		8,30
84511	25	2		12,90
84512	30	2		18,40



84509

Teller „STONE ART“

plate
plato
assiette



	Ø cm	↑ cm	ltr.	€
84509	15,5	2,5	0,15	6,30
84514	20,0	4,5	0,60	11,40



Teller „STONE ART“

plate
plato
assiette



	Ø cm	↑ cm		€
84515	24,5	3,5		14,30



Teller „STONE ART“

plate
plato
assiette



	cm	↑ cm		€
84517	33 x 32,5	3		26,30



Schale „STONE ART“

bowl
cuenco
bol



	Ø cm	↑ cm	ltr.	VE / unit	€ / pc.
84523	8	3	0,07	12	2,90



Schale „STONE ART“

bowl
cuenco
bol



	Ø cm	↑ cm	ltr.	€
84524	12	6	0,3	5,60



Schale „STONE ART“

bowl
cuenco
bol



	Ø cm	↑ cm	ltr.	€
84525	15	7,5	0,6	6,90



Schale „STONE ART“

bowl
cuenco
bol



	cm	↑ cm	ltr.	€
84526	23 x 19	6,5	0,6	12,50



Schale „STONE ART“

bowl
cuenco
bol



	cm	↑ cm	ltr.	€
84528	28,5 x 21	7,5	1,2	20,70



84529

Schale „STONE ART“

bowl
cuenco
bol



	cm	↑ cm	ltr.	€
84529	19 x 19	6,0	0,5	13,60
84530	24 x 24	6,5	1,1	18,90

STONE ART



GN Tablett „STONE ART“

GN tray
GN bandeja
GN plateau



	cm	↑ cm	GN	€
84519	53,0 x 32,5	1,5	1/1	49,40
84520	32,5 x 26,5	1,5	1/2	27,10
84522	53,0 x 16,2	1,5	2/4	28,20
84521	32,5 x 17,6	1,5	1/3	19,90



GN Abdeckhaube

GN cover
GN cubierta
GN cloche



passend für GN Tablett, glasklarer Kunststoff, nahezu unzerbrechlich

suitable for GN trays, clear plastic, nearly unbreakable

apto para bandejas GN, plástico transparente, muy resistente a la rotura

pour plateaux GN, plastique transparent, très résistant à la casse

	cm	↑ cm	✂ mm	GN	€
11043	32,5 x 17,6	10,5	3	1/3	17,00
11044	53,0 x 16,2	10,5	3	2/4	23,00

	cm	↑ cm	✂ mm	GN	€
11041	32,5 x 26,5	9,5	3	1/2	23,00
11042	53,0 x 32,5	9,5	3	1/1	32,00

FOOTMARK



Schale „FOOTMARK“

bowl
cuenco
bol



	Ø cm	↑ cm	ltr.	€
85320	13	5,5	0,25	6,90
85321	18	5,5	0,6	10,00

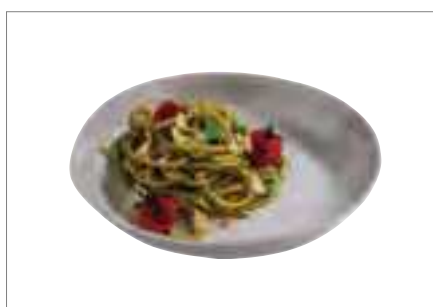

Teller, tief „FOOTMARK“

plate, deep
plato hondo
assiette creuse



	Ø cm	↑ cm	ltr.	€
85322	24	4	0,8	13,00



Teller „FOOTMARK“

plate
plato
assiette



	Ø cm	↑ cm	ltr.	€
85323	21	2		9,60
85324	26,5	2,5		12,80



LOOPS



GN Tablett „LOOPS“

GN tray
GN bandeja
GN plateau



	cm	↑ cm	GN	€
85021	32,5 x 26,5	1,5	1/2	25,20



Tablett/Sushiboard „LOOPS“

tray
bandeja
plateau



	cm	↑ cm	€
85025	23,5 x 13,5	1,5	8,80



Teller „LOOPS“

plate
plato
assiette



	Ø cm	↑ cm	€
85027	22	2	9,00
85028	27	2	14,50

85027



Teller „LOOPS“

plate
plato
plateau



	Ø cm	↑ cm	€
85024	34 x 15,5	4	19,60



Schale „LOOPS“

bowl
cuenco
bol



	Ø cm	↑ cm	ltr.	€
85026	18	3	0,25	7,60



85029 1,0 ltr.

85029 2,0 ltr.

Schale „LOOPS“

bowl
cuenco
bol



	Ø cm	↑ cm	ltr.	€
85029	20,5	6,5	1,0	16,70
85030	31,0	8,0	2,0	36,20



85036 0,5 ltr.

85037 1,0 ltr.

85038 1,8 ltr.

Schale „LOOPS“

bowl
cuenco
bol



	Ø cm	↑ cm	ltr.	€
85036	15,0	7,0	0,5	8,00
85037	18,5	8,0	1,0	14,80
85038	24,0	9,0	1,8	22,00



Teller „LOOPS“

plate
plato
assiette



	cm	↑ cm	€
85055	28 x 13,5	4,0	14,00



Teller „LOOPS“

plate
plato
assiette



	Ø cm	↑ cm	€
85056	23	3,5	15,00



Teller „LOOPS“

plate
plato
assiette



	Ø cm	↑ cm	€
85057	25,5	4,5	15,00



CANCUN



Tablett/Sushiboard „CANCUN“
tray/sushiboard
bandeja para sushi
plateau sushi



	cm	↑ cm	€
85200	23,5 x 13,5	1,5	8,80



Teller „CANCUN“
plate
plato
assiette



	cm	↑ cm	€
85201	28 x 13,5	4,0	14,00



Schale „CANCUN“
bowl
cuenco
bol



	Ø cm	↑ cm	ltr.	€
85205	15,0	7,0	0,5	8,00
85206	18,5	8,0	1,0	14,80
85207	20,5	6,5	1,0	16,70
85208	24,0	9,0	1,8	22,00



Teller „CANCUN“
plate
plato
assiette



	Ø cm	↑ cm	€
85202	18,0	3,0	7,60
85203	23,0	3,5	15,00



Teller „CANCUN“
plate
plato
assiette



	Ø cm	↑ cm	€
85204	25,5	4,5	15,00

BAMBOO



84816

Schale „BAMBOO“

bowl
cuenco
bol



	cm	↑ cm	ltr.	€
84815	10,5 x 10,0	3,0	0,03	3,00
84816	17,5 x 15,5	5,5	0,2	7,90



Schale „BAMBOO“

bowl
cuenco
bol



	Ø cm	↑ cm	ltr.	€
84819	30,5	8,5	2	22,40



84806

84807

84808

Tablett „BAMBOO“

tray
bandeja
plateau



	cm	↑ cm	€
84806	21,0 x 13,0	3,0	6,20
84807	24,5 x 15,5	3,0	9,70
84808	34,5 x 21,5	3,0	19,50



CRAZY WOOD



GN Tablett „CRAZY WOOD“

GN tray
GN bandeja
GN plateau



	cm	↑ cm	GN	€
85300	32,5 x 26,5	1	1/2	25,00
85301	32,5 x 17,6	1	1/3	19,20
85302	53 x 16,2	1	2/4	26,00



Präsentationsmöglichkeit
presentation example

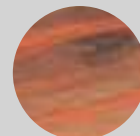

Farbstreifen in Orange
orange color stripes



Tablett „CRAZY WOOD“

tray
bandeja
plateau



Servierfläche: 34 x 17,5 cm, Gesamtlänge: 45 cm, mit Hängeloch: Ø 0,8 cm

serving area: 34 x 17,5 cm, total length: 45 cm, handle hole: Ø 0,8 cm

superficie servicio: 34 x 17,5 cm, longitud total: 45 cm, con agujero para colgar: Ø 0,8cm

surface de service: 34 x 17,5 cm, longueur totale: 45 cm, avec trou de suspension: Ø 0,8cm

	cm	↑ cm	Griff / handle cm	€
85303	45 x 17,5	1,5	11	29,00



Tablett „CRAZY WOOD“

tray
bandeja
plateau



Servierfläche: 40 x 20 cm, Grifflänge: 13 cm, Gesamtlänge: 53 cm, mit Hängeloch: Ø 0,8 cm

serving area: 40 x 20 cm, total length: 53 cm, handle hole: Ø 0,8 cm

superficie de servicio: 40 x 20 cm, longitud total: 53 cm, con agujero para colgar: Ø 0,8cm

surface de service: 40 x 20 cm, longueur totale: 53 cm, avec trou de suspension: Ø 0,8cm

	Ø cm	↑ cm	Griff / handle cm	€
85304	53 x 20	1,5	13	34,00



Teller „CRAZY WOOD“

plate
plato
assiette



	Ø cm	↑ cm	€
85305	15	1,5	7,60
85306	20	1,5	11,50
85307	26	2	17,20

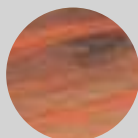

Farbstreifen in Orange
orange color stripes



Schale „CRAZY WOOD“

bowl
cuenco
bol



	Ø cm	↑ cm	ltr.	€
85308	12,5	4,5	0,25	10,00
85309	12,5	5,5	0,5	16,80
85310	20,5	7,5	1,2	24,00

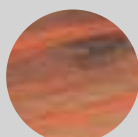

Farbstreifen in Orange
orange color stripes



GN Schale „CRAZY WOOD“

GN bowl
GN cuenco
GN bol



	cm	↑ cm	ltr.	GN	€
85311	26,5 x 16,2	8	1,8	1/4	22,40
85312	53 x 16,2	8	4,0	2/4	30,00

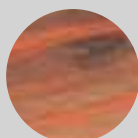

Farbstreifen in Orange
orange color stripes

EMMA



85101 0,06 ltr



85104 0,50 ltr



85111 2,3 ltr

Schale „EMMA“ bowl cuenco bol



	Ø cm	↑ cm	ltr.	Farbe / Colour	€
85100	7,5	3,5	0,06	■	5,50
85101	7,5	3,5	0,06	■	5,50
85103	7,5	3,5	0,06	■	5,50
85104	14	6,5	0,5	■	9,90
85105	14	6,5	0,5	■	9,90
85107	14	6,5	0,5	■	9,90
85108	23	10,5	2,3	■	22,00
85109	23	10,5	2,3	■	22,00
85111	23	10,5	2,3	■	22,00





85120 GN 1/4



85121 GN 1/4



85124 GN 1/2

GN Tablett „EMMA“

GN tray
GN bandeja
GN plateau



	cm	↑ cm	GN	Farbe / Colour	€
85120	26,5 x 16,2	3	1/4		15,40
85121	26,5 x 16,2	3	1/4		15,40
85124	32,5 x 26,5	3	1/2		24,20
85125	32,5 x 26,5	3	1/2		24,20



85128 1,5 ltr



85129 1,5 ltr



85133 3,5 ltr

GN Schale „EMMA“

GN bowl
GN cuenco
GN bol



	cm	↑ cm	ltr.	GN	Farbe / Colour	€
85128	26,5 x 16,2	7,5	1,5	1/4		20,90
85129	26,5 x 16,2	7,5	1,5	1/4		20,90
85132	32,5 x 26,5	7,5	3,5	1/2		28,60
85133	32,5 x 26,5	7,5	3,5	1/2		28,60



ARABESQUE

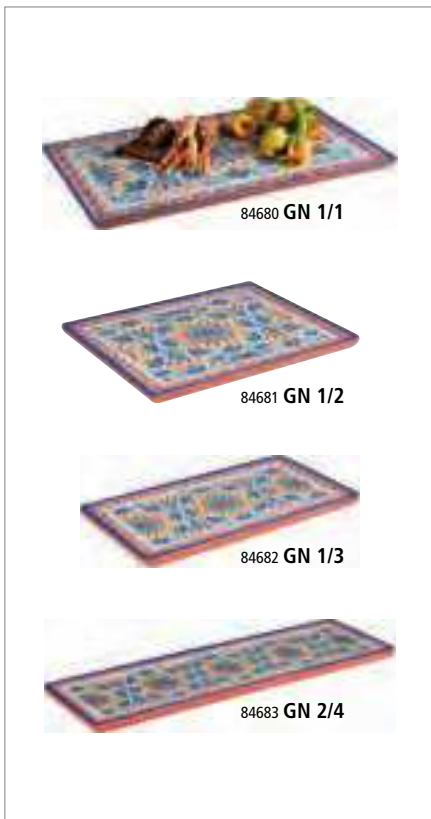

GN Tablett „ARABESQUE“

GN tray
GN bandeja
GN plateau



	cm	↑ cm	GN	€
84680	53,0 x 32,5	2	1/1	50,60
84681	32,5 x 26,5	2	1/2	27,60
84682	32,5 x 17,6	2	1/3	20,70
84683	53,0 x 16,2	2	2/4	28,80



Teller „ARABESQUE“

plate
plato
assiette



	cm	↑ cm	€
84686	38 x 15,5	2	16,10



Schale „ARABESQUE“

bowl
cuenco
bol

	Ø cm	↑ cm	ltr.	€
84687	10,0	6	0,2	5,30
84691 <small>NEW</small>	13,0	7	0,4	7,00
84688	15,5	8	0,8	8,00



Schale „ARABESQUE“

bowl
cuenco
bol

	Ø cm	↑ cm	ltr.	€
84689	20,5	5,5	1,1	11,80
84692 <small>NEW</small>	22,5	4,5	0,7	11,80
84693 <small>NEW</small>	24,0	7,0	1,5	16,80
84690	31,0	9,0	3,0	24,20



Teller „ARABESQUE“

plate
plato
assiette

	Ø cm	↑ cm	€
84684	21,5	2	10,30
84685	26,5	2	14,30
84694 <small>NEW</small>	33,0	2	20,00

BLUE OCEAN

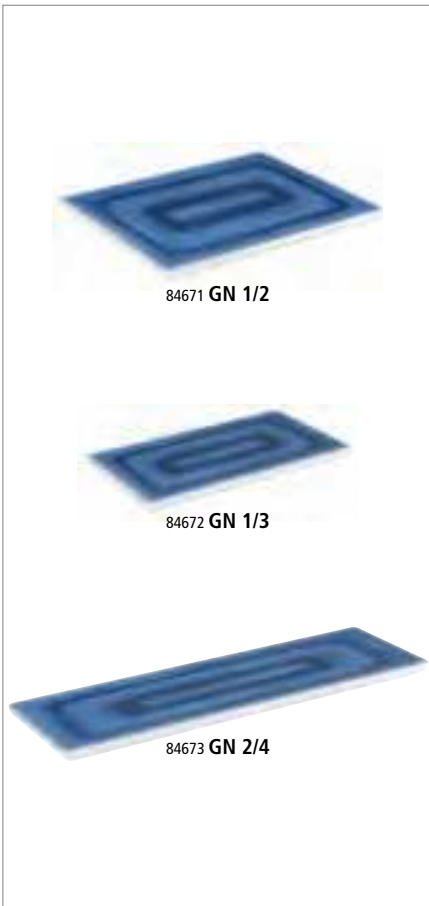

GN Tablett „BLUE OCEAN“

GN tray
GN bandeja
GN plateau



	cm	↑ cm	GN	€
84671	32,5 x 26,5	2	1/2	27,60
84672	32,5 x 17,6	2	1/3	20,50
84673	53,0 x 16,2	2	2/4	28,80

GN 1/2	GN 1/3	GN 2/4
	GN 1/3	
GN 1/2	GN 1/3	



84674



84675

Teller „BLUE OCEAN“

plate
plato
assiette



	∅ cm	↑ cm	€
84674	21,5	2	10,60
84675	26,5	2	14,30



Tablett „BLUE OCEAN“

tray
bandeja
plateau



	cm	↑ cm	€
84676	48 x 35,5	3	27,60



84677 0,6 ltr



84678 3,0 ltr

Schale „BLUE OCEAN“

bowl
cuenco
bol

	∅ cm	↑ cm	ltr.	€
84677	15	7,5	0,6	8,00
84678	30,5	9	3	20,70



ZEN

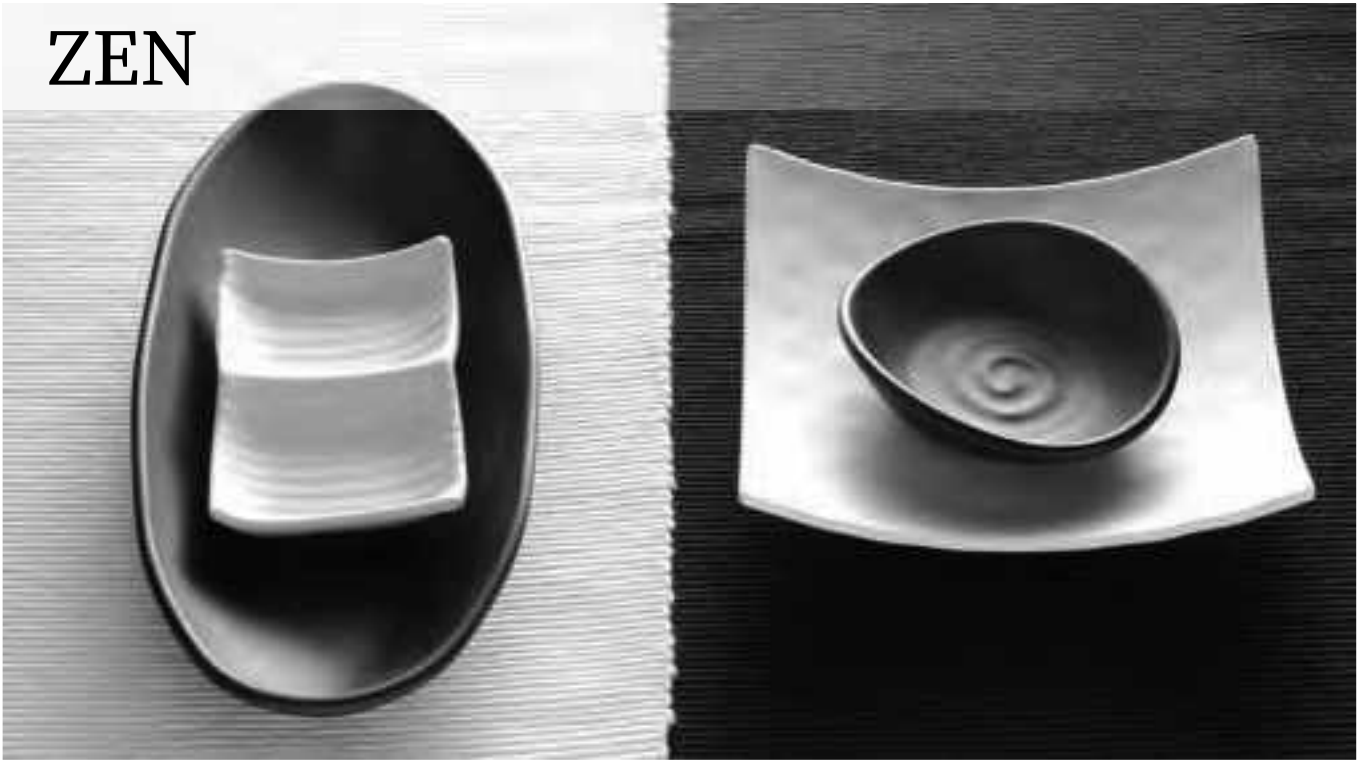

Schale „ZEN“

bowl
cuenco
bolMAX
70°C

	Ø cm	↑ cm	ltr	Farbe / Colour	€
83929	31	8,5	2,5	■	27,10



Schale „ZEN“

bowl
cuenco
bolMAX
70°C

	Ø cm	↑ cm	ltr	Farbe / Colour	€
84355	22,5	12,5	0,80	■	12,50



Schale „ZEN“

bowl
cuenco
bolMAX
70°C

	cm	↑ cm	ltr	Farbe / Colour	€
83712	21 x 21	11	1,40	■	13,60



Schale „ZEN“

bowl
cuenco
bol

	Ø cm	↑ cm	ltr.	Farbe / Colour	€
84348	10,0	7,0	0,08		3,50
84349	10,0	7,0	0,08		3,50
84351	12,5	8,5	0,15		5,20
84353	16,0	10,0	0,30		8,30

stapelbar
stackable

Schale „ZEN“

bowl
cuenco
bol

	cm	↑ cm	ltr.	Farbe / Colour	€
83735	25,0 x 13,5	4	0,25		5,20
83739	30,5 x 17,5	5	0,60		10,30



Schale „ZEN“

bowl
cuenco
bol

	cm	↑ cm	ltr.	Farbe / Colour	€
83716	17,5 x 17,5	7	0,5		8,00



Schale „ZEN“

bowl
cuenco
bol

	cm	↑ cm	ltr.	Farbe / Colour	€
83725	10,5 x 10,5	3	0,06		3,00
83727	10,5 x 10,5	3	0,06		3,00

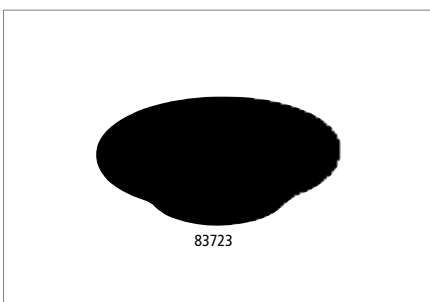

Dipschälchen „ZEN“

dip bowl
cuenco para dip
bol para dip

	Ø cm	↑ cm	ltr.	Farbe / Colour	VE / unit	€ / pc.
83721	8	1,5	0,03		24	1,30
83723	8	1,5	0,03		24	1,30



Schale „ZEN“

bowl
cuenco
bolMAX
70°C

	cm	↑ cm	ltr.	Farbe / Colour	€
83718	12 x 12	4	0,2	■	5,50
83720	12 x 12	4	0,2	■	5,50



Schale „ZEN“

bowl
cuenco
bolMAX
70°C

	cm	↑ cm	ltr.	Farbe / Colour	€
83726	13 x 11	3,5	0,1	■	3,20
83728	13 x 11	3,5	0,1	■	3,20



Schale „ZEN“

bowl
cuenco
bolMAX
70°C

	cm	↑ cm	ltr.	Farbe / Colour	VE / unit	€ / pc.
83730	11 x 10	3	0,04	■	12	2,80
83732	11 x 10	3	0,04	■	12	2,80



Schale „ZEN“

bowl
cuenco
bolMAX
70°C

	cm	↑ cm	ltr.	Farbe / Colour	€
83722	17,5 x 15,5	5,5	0,2	■	7,40
83724	17,5 x 15,5	5,5	0,2	■	7,40



Schale „ZEN“

bowl
cuenco
bolMAX
70°C

	cm	↑ cm	ltr.	Farbe / Colour	€
83935	14,5 x 12,5	5	0,2	■	5,60



Schale „ZEN“

bowl
cuenco
bolMAX
70°C

	Ø cm	↑ cm	ltr.	Farbe / Colour	€
83932	11,5	4	0,15	■	5,30
83933	11,5	4	0,15	■	5,30



Schale „ZEN“

bowl
cuenco
bol

	cm	↑ cm	ltr.	Farbe / Colour	VE / unit	€ / pc.
83946	9 x 7	2,5	0,05	■	24	4,00
83947	9 x 7	2,5	0,05	■	24	4,00

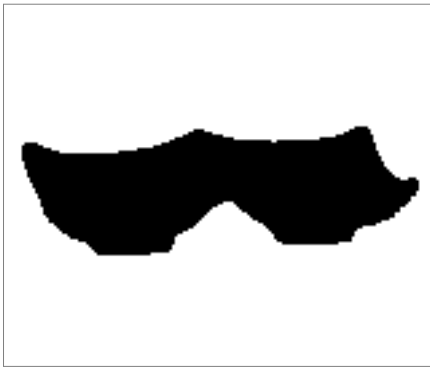

Schale „ZEN“

bowl
cuenco
bol

	cm	↑ cm	Farbe / Colour	€
83949	14 x 9	2,5	■	4,50



Tablett / Teller „ZEN“

tray / plate
bandeja / plato
plateau / assiette

	Ø cm	↑ cm	Farbe / Colour	€
83941	28	3	■	11,50



Tablett / Sushiboard „ZEN“

tray / sushiboard
bandeja para sushi
plateau sushi

	cm	↑ cm	Farbe / Colour	€
83742	22,5 x 9,5	3	■	5,00
83744	22,5 x 9,5	3	■	5,00



Tablett / Sushiboard „ZEN“

tray / sushiboard
bandeja para sushi
plateau sushi

	cm	↑ cm	Farbe / Colour	€
83740	22 x 12	3	■	6,80

MARONE



Blattschale „MARONE“
leaf
fuente en forma de hoja
plateau feuille



	cm	↑ cm	ltr.	€
84100	25,5 x 14	5,5	0,4	9,80
84101	36,0 x 19	8,0	0,9	15,00



Schale „MARONE“
bowl
cuenco
bol



	cm	↑ cm	ltr.	€
84731	16,5 x 10	5,5	0,25	12,00
84732	22,0 x 13	7,5	0,6	14,40
84733	27,5 x 19	9,0	1,4	17,20



Oberflächenansicht
surface view



84107 **0,05 ltr.**



84108 **0,04 ltr.**

Schale „MARONE“

bowl
cuenco
bol



	Ø cm	↑ cm	ltr.	VE / unit	€ / pc.
84107	8,5	2,5	0,05	12	6,50
84108	11,5	3,0	0,04	12	6,90



84115 **0,13 ltr.**



84116 **0,2 ltr.**

Schale „MARONE“

bowl
cuenco
bol



	Ø cm	↑ cm	ltr.	€
84115	11	3,5	0,13	6,50
84116	14	4,0	0,20	7,20



84109 **0,2 ltr.**

Schale „MARONE“

bowl
cuenco
bol



	Ø cm	↑ cm	ltr.	€
84109	11	5,5	0,2	6,70



84111 **0,8 ltr.**

Schale „MARONE“

bowl
cuenco
bol



	Ø cm	↑ cm	ltr.	€
84110	14	6,0	0,30	7,80
84111	19	8,0	0,80	14,00
84112	21	8,5	1,00	14,50
84113	24	9,5	1,40	17,00



84174 **2,0 ltr.**

Schale „MARONE“

bowl
cuenco
bol



	Ø cm	↑ cm	ltr.	€
84174	30,5	8,5	2	24,70

MARONE

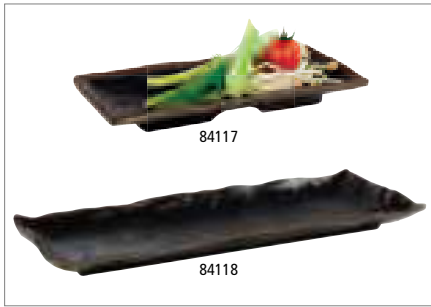

Tablett „MARONE“
tray
bandeja
plateau

original
APS
melamine

MAX
70°C

cm ↑ cm €

84117	19,5 x 9,5	2	10,00
84118	39,0 x 16,0	3	19,80



Tablett „MARONE“
tray
bandeja
plateau

original
APS
melamine

MAX
70°C

cm ↑ cm €

84119	32,5 x 23,5	4,5	19,80
-------	-------------	-----	-------



Tablett „MARONE“
tray
bandeja
plateau

original
APS
melamine

MAX
70°C

cm ↑ cm €

84104	22,5 x 15	3	12,00
84105	27,5 x 11	2	12,00



Tablett „MARONE“
tray
bandeja
plateau

original
APS
melamine

MAX
70°C

cm ↑ cm €

84103	14,5 x 14,5	2	6,50
-------	-------------	---	------



Tablett „MARONE“
tray
bandeja
plateau

original
APS
melamine

MAX
70°C

cm ↑ cm €

84106	26,5 x 16,5	4	13,80
-------	-------------	---	-------



Teller „MARONE“
plate
plato
assiette

original
APS
melamine

MAX
70°C

Ø cm ↑ cm €

84729	20,5	2,5	8,70
84730	28,0	3,5	10,70

AIKO



84329 0,07 ltr.



84331 0,2 ltr.

Schale „AIKO“

bowl
cuenco
bol

Steinoptik

appearance stoneware
su aspecto recuerda al gres
l'aspect de la mélamine rapelle le grès



	Ø cm	↑ cm	ltr.	Farbe / Colour	VE / unit	€/ pc.
84329	8,0	4	0,07	■	24	3,80
84331	11,5	6	0,20	■		5,10



84335 0,6 ltr.



84337 1,2 ltr.

Schale „AIKO“

bowl
cuenco
bol

Steinoptik

appearance stoneware
su aspecto recuerda al gres
l'aspect de la mélamine rapelle le grès



	Ø cm	↑ cm	ltr.	Farbe / Colour	€
84335	16,0	7	0,6	■	8,30
84337	20,5	8	1,2	■	12,70



GN Tablett „DARK WAVE“

GN tray
GN bandeja
GN plateau



	cm	↑ cm	GN	€
84900	53,0 x 32,5	2	1/1	46,50
84901	32,5 x 26,5	2	1/2	23,70
84902	32,5 x 17,6	2	1/3	14,30
84903	53,0 x 16,2	2	2/4	22,80

GN 1/1	GN 1/2	GN 1/3	GN 2/4
	GN 1/2	GN 1/3	
		GN 1/3	



Tablett „DARK WAVE“

tray
bandeja
plateau



	cm	↑ cm	€
84904	14 x 14	2	5,30



Tablett „DARK WAVE“

tray
bandeja
plateau



	cm	↑ cm	€
84905	23 x 10,5	1,5	7,40
84906	29 x 12,0	1,5	9,70



Teller „DARK WAVE“

plate
plato
assiette



	Ø cm	↑ cm	€
84907	14,5	1,5	4,00
84908	22,0	2,0	8,00
84909	27,0	2,5	12,00



Schale „DARK WAVE“

bowl
cuenco
bol



	Ø cm	↑ cm	ltr.	€
84910	17,5	5,0	0,50	9,00
84911	22,5	5,0	0,75	11,80
84912	32,0	3,5	–	19,40

HALFTONE



Fingerfoodlöffel „HALFTONE“
party spoon
cuchara party
cuillère party



	Ø cm	↑ cm	VE / unit	€ / pc.
84158	5,5	7	24	3,70



Fingerfoodlöffel „HALFTONE“
party spoon
cuchara party
cuillère party



	cm	↑ cm	VE / unit	€ / pc.
84128	14,5 x 4,5	4,5	12	3,70



Tablett „HALFTONE“
tray
bandeja
plateau



	cm	↑ cm	€
84125	24,5 x 15,0	3	8,70



Schale „HALFTONE“

bowl
cuenco
bol



	Ø cm	↑ cm	ltr.	VE / unit	€ / pc.
84217	8	4	0,1	12	4,00



Schale „HALFTONE“

bowl
cuenco
bol



	cm	↑ cm	ltr.	€
84130	11,5 x 7,0	4,0	0,05	3,40
84131	14,0 x 8,0	4,5	0,10	4,30
84133	17,5 x 13,5	6,5	0,35	7,20
84134	24,0 x 17,5	7,5	0,8	12,90



Schale „HALFTONE“

bowl
cuenco
bol



	Ø cm	↑ cm	ltr.	€
84135	16,5	7,5	0,65	10,20

PADELLA



Schale „PADELLA“

bowl
cuenco
bol



	Ø cm	↑ cm	ltr.	Griff / handle cm	€
85150	21	9	1,5	5 x 3,5	15,40
85151	28	9	3,0	5 x 3,5	23,00

CROCKER

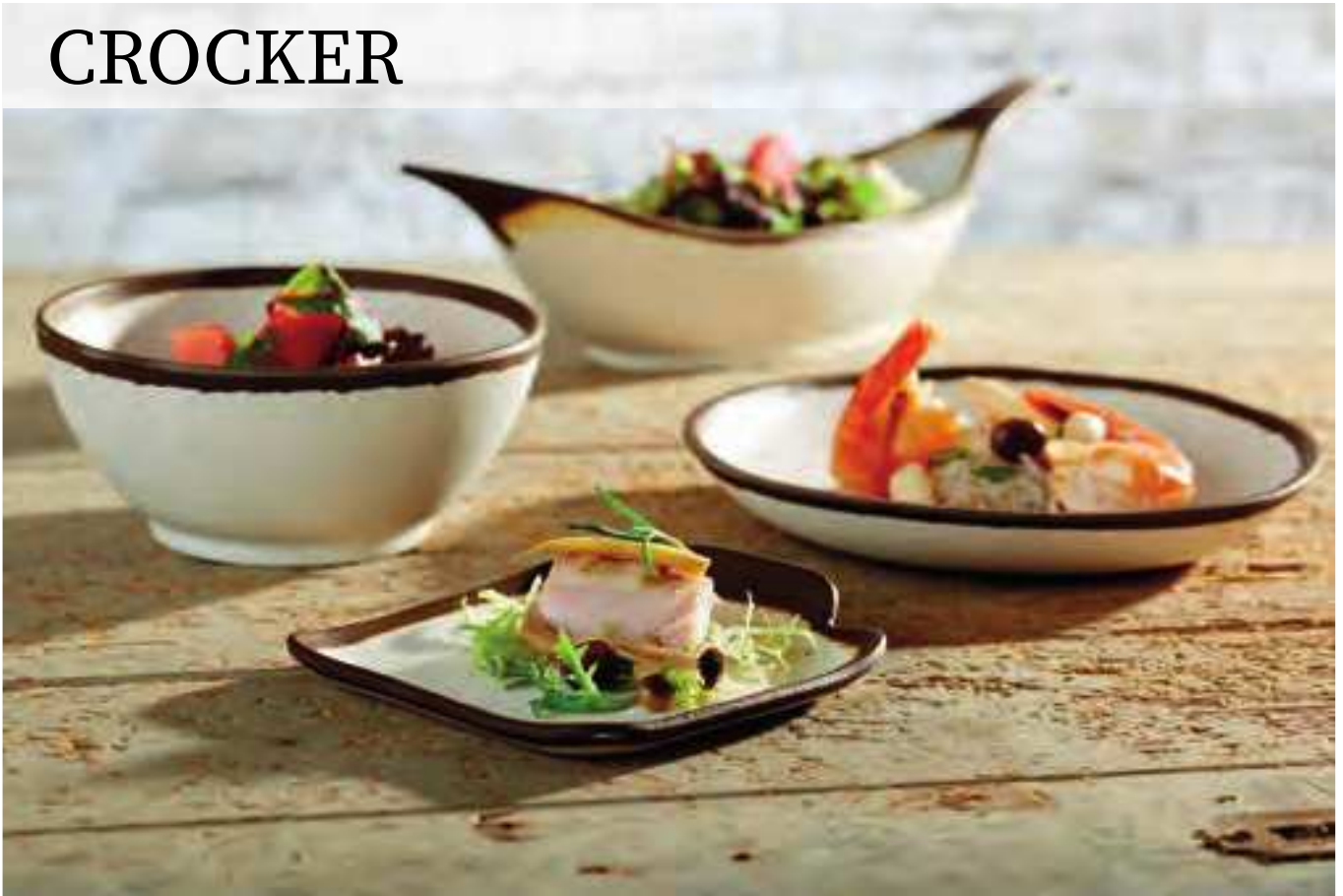

Teller „CROCKER“
plate
plato
assiette



	cm	↑ cm	Farbe / Colour	VE / unit	€ / pc.
84567	14 x 13	2,5		12	3,90
84568	14 x 13	2,5		12	3,90



Teller „CROCKER“
plate
plato
assiette



	Ø cm	↑ cm	litr.	Farbe / Colour	€
84575	20,5	3	0,50		7,40
84576	20,5	3	0,50		7,40



Schale „CROCKER“
bowl
cuenco
bol



	Ø cm	↑ cm	ltr.	Farbe / Colour	€
84573	16,5	4	0,50		6,80
84574	16,5	4	0,50		6,80



Schale „CROCKER“
bowl
cuenco
bol



	Ø cm	↑ cm	ltr.	Farbe / Colour	€
84569	12,5	6	0,37		4,20
84570	12,5	6	0,37		4,20
84571	16,0	7	0,70		7,00
84572	16,0	7	0,70		7,20
84577	21,0	8	1,45		12,00
84578	21,0	8	1,45		12,00



Blattschale „CROCKER“
leaf
fuente en forma de hoja
plateau feuille



	cm	↑ cm	ltr.	Farbe / Colour	€
84579	30,5 x 10	7,5	0,17		7,90
84580	30,5 x 10	7,5	0,17		7,90
84581	42,0 x 14	9,5	0,65		18,40
84582	42,0 x 14	9,5	0,65		18,40

ASIA+



15425

Teller „ASIA PLUS“ plate plato assiette



	Ø cm	↑ cm	Farbe / Colour	€
15424	11,0	2		3,30
15425	16,0	2		5,80



15461 0,04 ltr.

15462 0,13 ltr.

15467 0,04 ltr.

Schale „ASIA PLUS“



	Ø cm	↑ cm	ltr.	Farbe / Colour	€
15461	7,5	3,0	0,04		2,30
15462	7,5	6,5	0,13		3,30
15467	7,5	3,0	0,04		3,30

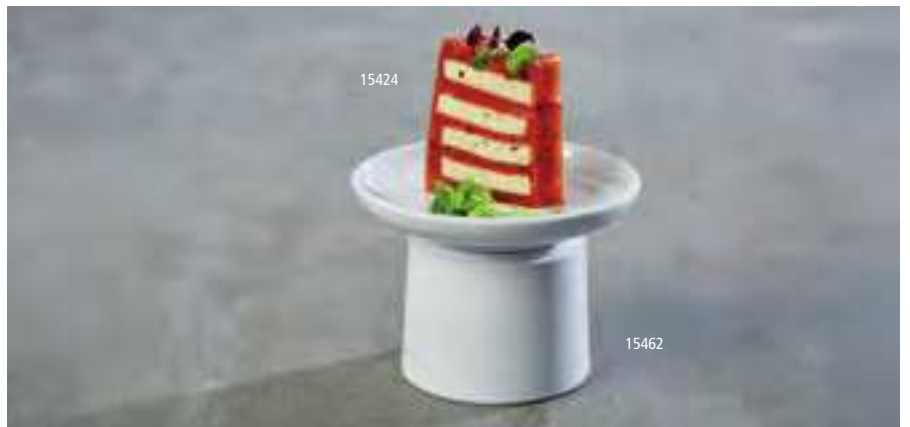

15424

15462



GN Tablett „ASIA PLUS“

GN tray
GN bandeja
GN plateau



	cm	↑ cm	GN	Farbe / Colour	€
15449	53,0 x 32,5	3	1/1		43,00
15450	32,5 x 26,5	3	1/2		24,00
15451	32,5 x 17,6	3	1/3		17,80
15452	26,5 x 16,2	3	1/4		14,00
15453	35,4 x 32,5	3	2/3		31,00
15454	53,0 x 16,2	3	2/4		28,00
15455	53,0 x 32,5	3	1/1		56,00
15456	32,5 x 26,5	3	1/2		27,80
15457	32,5 x 17,6	3	1/3		22,80
15458	26,5 x 16,2	3	1/4		18,80
15460	53,0 x 16,2	3	2/4		35,00

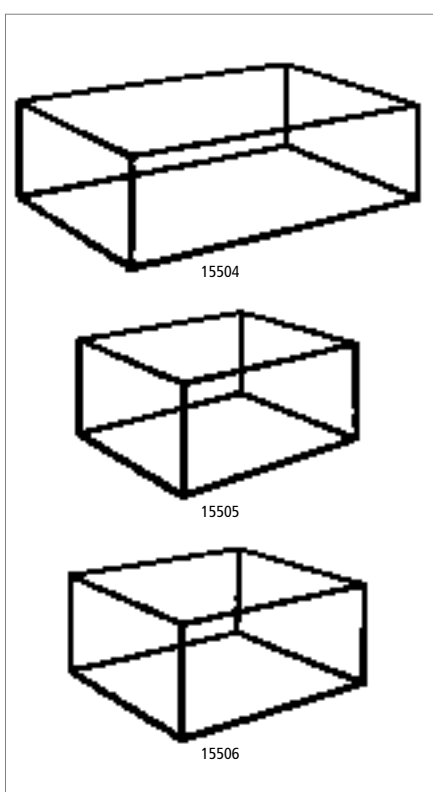
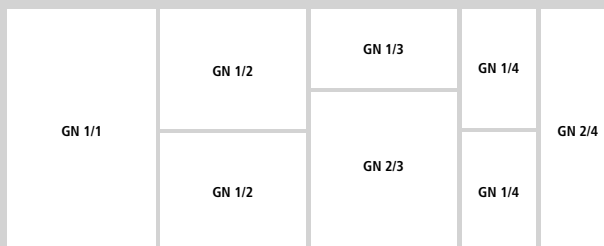

GN Buffetständer „ASIA PLUS“

GN buffet stand
GN soporte para buffet
GN présentoir buffet



	cm	GN	Farbe / Colour	€
15504	53,0 x 32,5 / 53,0 x 16,2	1/1 / 2/4		29,90
15505	32,5 x 26,5 / 26,5 x 16,2	1/2 / 1/4		17,80
15506	32,5 x 17,5 / 35,4 x 32,5	1/3 / 2/3		22,80



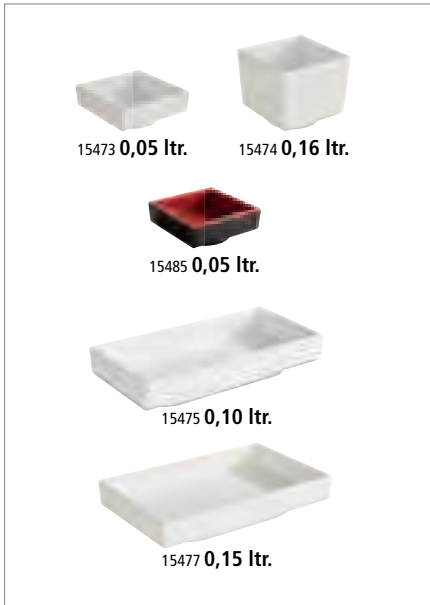

Schale „ASIA PLUS“

original APS melamine MAX 70°C

	cm	↑ cm	ltr.	Farbe / Colour	€
15473	7,5 x 7,5	3,0	0,05		2,60
15474	7,5 x 7,5	6,5	0,16		3,50
15485	7,5 x 7,5	3,0	0,05		4,10
15475	15,5 x 7,5	3,0	0,10		4,10
15477	15,5 x 9,5	3,0	0,15		4,40



Schale „ASIA PLUS“

bowl cuenco bol

original APS melamine MAX 70°C

	Ø cm	↑ cm	ltr.	Farbe / Colour	€
15400	7,5	3,5	0,06		2,60
15401	9,5	4,5	0,13		3,70
15402	13,0	5,5	0,35		6,30
15403	16,0	7,0	0,60		8,60
15404	20,0	8,0	1,10		13,80
15416	7,5	3,5	0,06		2,60
15417	9,5	4,5	0,13		3,70
15418	13,0	5,5	0,35		6,30
15419	16,0	7,0	0,60		8,60
15420	20,0	8,0	1,10		13,80
15421	24,0	9,5	2,20		20,70

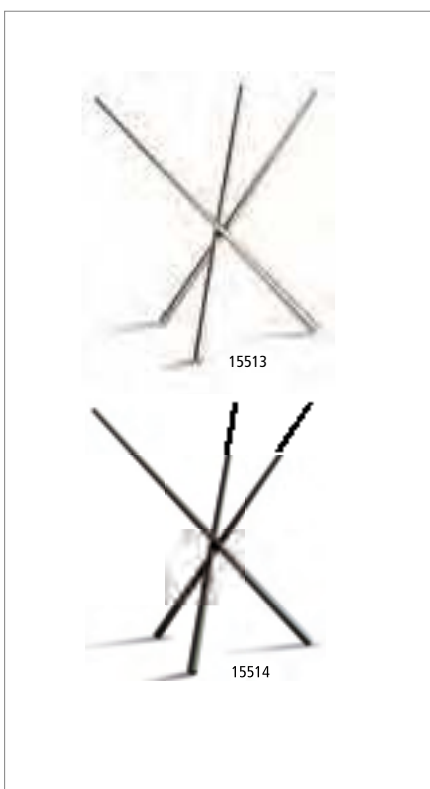

Buffetständer „ASIA PLUS“

buffet stand soporte para buffet présentoir buffet

EDELSTAHL STAINLESS INOX 18/8

	Ø cm	↑ cm	Farbe / Colour	€
15513	20,5 / 16,5	20		16,80
15514	20,5 / 16,5	20		15,60



GLAMOUR



Schale „GLAMOUR“

bowl
cuenco
bol



	Ø cm	↑ cm	ltr.	€
84365	8	3	0,05	2,00



Schale „GLAMOUR“

bowl
cuenco
bol



	Ø cm	↑ cm	ltr.	€
84366	12	5	0,25	2,60



Tablett „GLAMOUR“

tray
bandeja
plateau



	cm	↑ cm	€
84377	22 x 12	3,0	4,00
84378	37 x 11	2,5	10,90

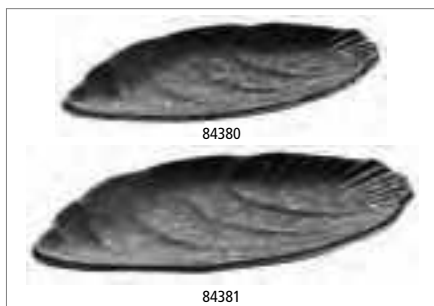

Tablett „GLAMOUR“

tray
bandeja
plateau



	cm	↑ cm	€
84380	25,0 x 15,5	1,5	3,60
84381	30,5 x 19,0	1,5	5,60



Tablett „GLAMOUR“

tray
bandeja
plateau



	cm	↑ cm	€
84379	30 x 11	3	6,00

ELEMENT



84825 0,01 ltr.

84826 0,02 ltr.

84820 0,03 ltr.

84821 0,04 ltr.

84827 0,18 ltr.

Schale „ELEMENT“

bowl
cuenco
bol



	cm	↑ cm	ltr.	VE / unit	€ / pc.
84825	∅ 8,0	2,0	0,01	24	1,80
84826	10,5 x 10,0	3,0	0,02	24	3,40
84820	9,0 x 7,0	3,0	0,03	24	3,40
84821	10,5 x 10,5	3,0	0,04	12	3,80
84827	17,5 x 15,5	5,5	0,18		7,90



84828 0,5 ltr

84829 3,0 ltr

Schale „ELEMENT“

bowl
cuenco
bol



	∅ cm	↑ cm	ltr.	€
84828	16	7	0,5	9,20
84829	28	12	3,0	26,70



84831 3,0 ltr

Schale „ELEMENT“

bowl
cuenco
bol



	cm	↑ cm	ltr.	€
84830	19 x 19	9	1,5	26,70
84831	25 x 25	12	3,8	40,30



Tablett „ELEMENT“

tray
bandeja
plateau



	cm	↑ cm	€
84824	31 x 10,5	1,5	10,20

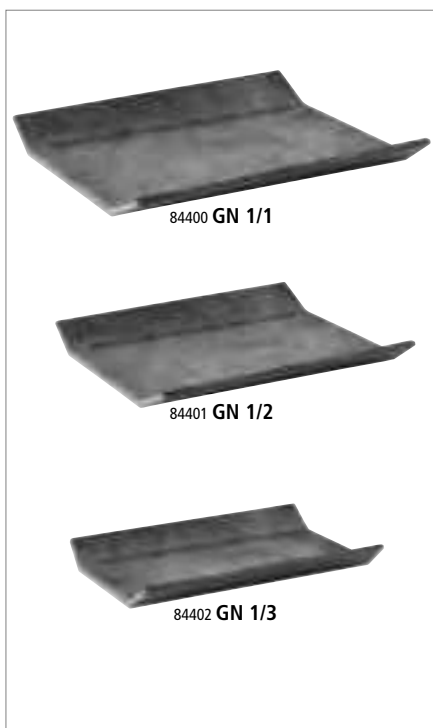

84400 GN 1/1

84401 GN 1/2

84402 GN 1/3

GN Tablett „ELEMENT“

GN tray
GN bandeja
GN plateau



	cm	↑ cm	GN	€
84400	53,0 x 32,5	3,5	1/1	44,00
84401	32,5 x 26,5	3,5	1/2	24,20
84402	32,5 x 17,5	3,5	1/3	17,80
84403	26,5 x 16,2	3,5	1/4	13,80
84404	53,0 x 16,2	3,5	2/4	26,70



84835 0,7 ltr.

84836 1,45 ltr.

84837 2,3 ltr.

Schale „ELEMENT LOOK“

bowl
cuenco
bol



	Ø cm	↑ cm	ltr.	€
84835	21,5	5,5 / 9,5	0,7	27,40
84836	26,0	7,0 / 12,5	1,45	33,00
84837	30,0	8,5 / 14,5	2,3	47,00

MEDITERRANEAN



Schale / Teller „MEDITERRANEAN“

bowl / plate
cuenco / plato
bol / assiette



	cm	↑ cm	ltr.	€
85290	18,5 x 11,5	3	0,2	10,00



Präsentationsmöglichkeit
presentation example



Schale „MEDITERRANEAN“

bowl
cuenco
bol



	Ø cm	↑ cm	ltr.	€
85291	20,5	8	1,2	25,00



Präsentationsmöglichkeit
presentation example

LA VIDA

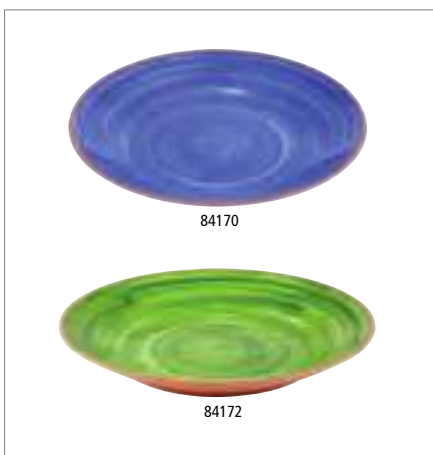

Tablett „LA VIDA“

plate / tray
plato / bandeja
assiette / plateau



	Ø cm	↑ cm	Farbe / Colour	€
84161	32,0	3,5		33,40
84170	40,5	5,5		48,30
<hr/>				
	Ø cm	↑ cm	Farbe / Colour	€
84171	32,0	3,5		33,40
84172	40,5	5,5		48,30

84170

84172

ENAMEL LOOK

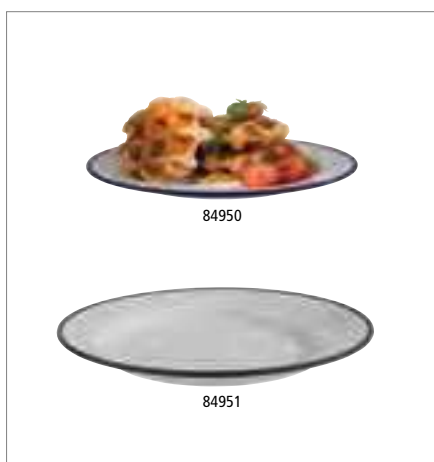

Teller „ENAMEL LOOK“

plate
plato
assiette



	Ø cm	↑ cm	Farbe / Colour	€
84950	20,5	2,0		6,30
84951	24,5	2,5		8,30



Schale „ENAMEL LOOK“

bowl
cuenco
bol



	cm	↑ cm	ltr.	Farbe / Colour	€
84958	15,0 x 11,5	6,5	0,30		3,70
84959	21,5 x 16,5	9,5	1,00		8,30



Schale „ENAMEL LOOK“

bowl
cuenco
bol



	Ø cm	↑ cm	ltr.	Farbe / Colour	€
84490	5,5	4,0	0,02		2,20
84491	9,5	4,5	0,09		3,70
84492	13,0	6,5	0,30		8,00

FRIDA



GN Schale „FRIDA“

GN bowl
GN cuenco
GN bol



	cm	↑ cm	ltr.	GN	Farbe / Colour	€
84555	17,6 x 10,8	5,5	0,5	1/9	White/Yellow	10,20
84556	17,6 x 10,8	5,5	0,5	1/9	Black/Yellow	10,20
84583	17,6 x 16,2	7,5	1,0	1/6	White/Yellow	15,50
84584	17,6 x 16,2	7,5	1,0	1/6	Black/Yellow	15,50
84586	26,5 x 16,2	7,5	1,8	1/4	White/Yellow	23,60
84587	26,5 x 16,2	7,5	1,8	1/4	Black/Yellow	23,60
84564	53 x 16,2	7,5	3,65	2/4	White/Yellow	31,60
84565	53 x 16,2	7,5	3,65	2/4	Black/Yellow	31,60
84589	32,5 x 26,5	7,5	4,0	1/2	White/Yellow	32,50
84590	32,5 x 26,5	7,5	4,0	1/2	Black/Yellow	32,50

84936 **0,37 ltr.**84959 **0,85 ltr.**84561 **2,65 ltr.**

Schale „FRIDA“

bowl
cuenco
bol

	cm	↑ cm	ltr.	Farbe / Colour	€
84936	12,5 x 12,5	4,5	0,37		7,60
84937	12,5 x 12,5	4,5	0,37		7,60
84558	16,5 x 16,5	5,5	0,85		11,50
84559	16,5 x 16,5	5,5	0,85		11,50
84561	25,0 x 25,0	7,5	2,65		21,40
84562	25,0 x 25,0	7,5	2,65		21,40

passende Deckel / suitable lid / tapa adecuada / couvercle approprié

	cm	↑ cm	fits to	€
84965	13,0 x 13,0	2,5	84936, 84937	3,10
84966	17,0 x 17,0	2,5	84558, 84559	3,40

84592 **3,5 ltr.**84593 **3,5 ltr.**

83601

Schale „FRIDA“

bowl
cuenco
bol

	cm	↑ cm	ltr.	Farbe / Colour	€
84592	25 x 25	12	3,5		32,50
84593	25 x 25	12	3,5		32,50

Deckel „PURE“ mit Löffelaussparung

cover with notched for spoons
tapa con espacio para la cuchara
couvercle avec encoche pour la louche

	cm	↑ cm	fits to	€
83601	25 x 25	1,5	84561, 84562, 84592, 84593	10,40

mit Deckel stapelbar
stackable with cover

1,2 ltr.

Schale „FRIDA“

bowl
cuenco
bol

	cm	↑ cm	ltr.	Farbe / Colour	€
84948	33,5 x 21	4	1,2		19,00

als Schütte geeignet
suitable as a chute

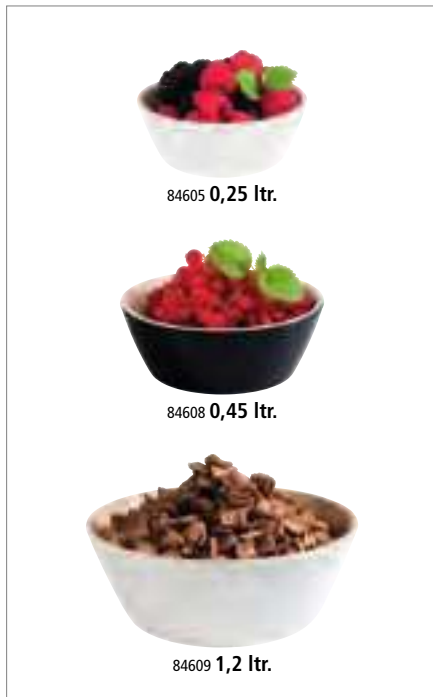

Schale „FRIDA“
bowl
cuenco
bol

original
APS
melamine

MAX
70°C

fits to

	Ø cm	↑ cm	ltr.	Farbe / Colour	€
84605	12,5	4,5	0,25		11,00
84606	12,5	4,5	0,25		11,00
84607	15,0	5,5	0,44		18,00
84608	15,0	5,5	0,44		18,00
84609	20,0	7,5	1,20		27,00
84610	20,0	7,5	1,20		27,00

passende Deckel / suitable lid / tapa adecuada / couvercle approprié

	Ø cm	↑ cm	fits to	€
84963	13,0	2,5	84605, 84606	3,40



Schale „FRIDA“
bowl
cuenco
bol

original
APS
melamine

MAX
70°C

NON
SLIP FEET

fits to

	Ø cm	↑ cm	ltr.	Farbe / Colour	€
84611	22,0	10,5	2,2		29,30
84612	22,0	10,5	2,2		29,30
84613	26,5	10,5	3,4		36,70
84614	26,5	10,5	3,4		36,70



Schale „FRIDA“
bowl
cuenco
bol

original
APS
melamine

MAX
70°C

fits to

	Ø cm	↑ cm	ltr.	Farbe / Colour	€
84930	8,5	3,5	0,1		3,80
84931	8,5	3,5	0,1		3,80
84932	21,5	7,5	1,8		26,00
84933	21,5	7,5	1,8		26,00
84934	30,0	9,5	4,7		42,80
84935	30,0	9,5	4,7		42,80

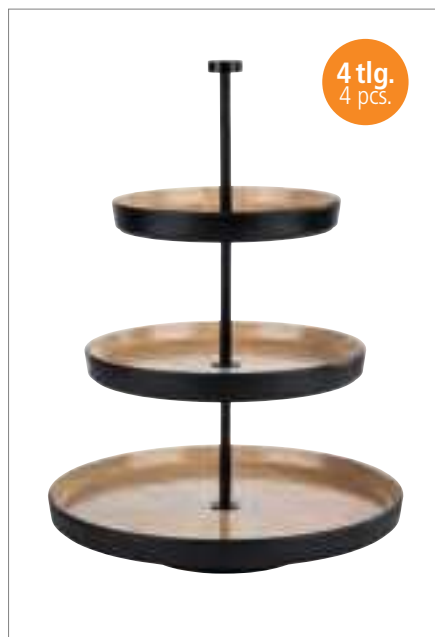
**3-stufige Etagère „FRIDA“**

3-tier tray
bandeja con 3 alturas
étagère carré 3 hauteurs



1 Gestell aus Edelstahl, schwarz, 3 Schalen aus Melamin: Ø 20 / 25 / 32 cm

1 stainless steel frame, black, 3 melamine bowls: Ø 20 / 25 / 32 cm

1 soporte de acero inoxidable, negro, 3 cuencos de melamina: Ø 20 / 25 / 32 cm

1 support en acier inox, noir, 3 bols en mélamine: Ø 20 / 25 / 32 cm

	Ø cm	↑ cm	Farbe / Colour	€
85211	20 / 25 / 32	43	■ ■ ■	98,00

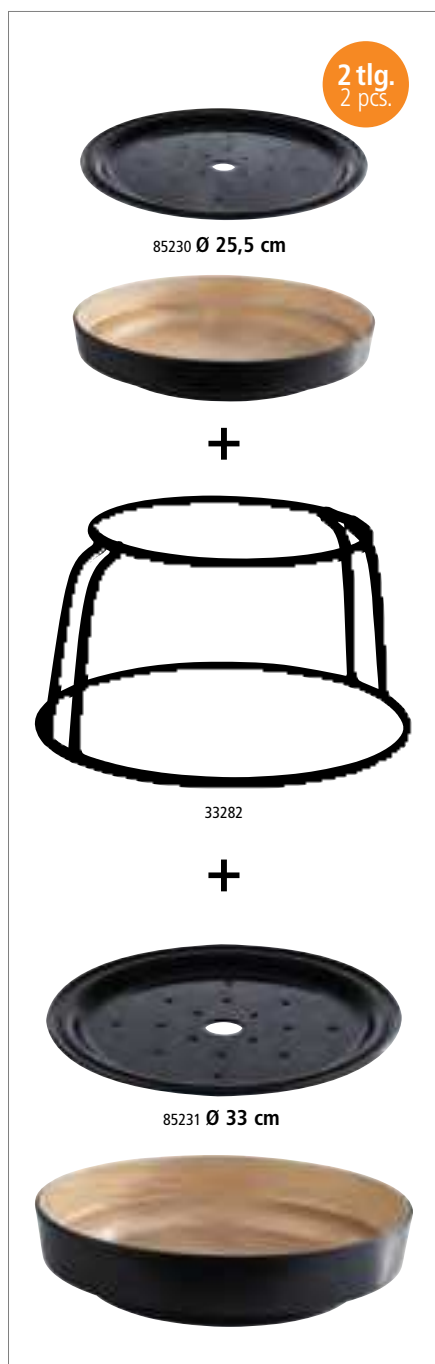
**Schale, 2-teilig „FRIDA“**

bowl, 2 pcs.
cuenco, set de 2
bol, set de 2



inklusive Abtropfeinsatz

including drip tray

con escurridor

avec égouttoir

	Ø cm	↑ cm	Farbe / Colour	€
85230	25,5	6	■ ■ ■	29,00
85231	33,0	6	■ ■ ■	49,00

Buffetständer

buffet stand
soporte para buffet
présentoir buffet



Metall, mit schwarzer Antirutschbeschichtung, für Schalen Nr. 85230, 85231

metal, with black anti-slide coating, for bowls no. 85230, 85231

metal, con revestimiento antideslizante negro, para cuencos 85230, 85231

métal, avec revêtement antidérapant noir, pour bols 85230, 85231

	Ø cm	↑ cm	Farbe / Colour	€
33282	23 / 30,5	16	■ ■ ■	40,00

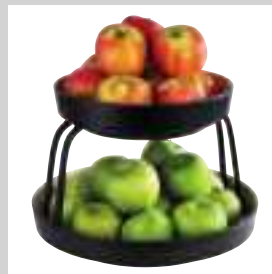

Präsentationsmöglichkeit
presentation example



inklusive Abtropfeinsatz
including drip tray



84920 1,0 ltr.

84921 1,0 ltr.

84922 1,6 ltr.

84925 2,6 ltr.

Schale „FRIDA LOCK“

bowl
cuenco
bol



Schalen lassen sich durch Drehmechanismus mit dem Ständer fest verbinden

bowls can be firmly connected to the stand by a turning mechanism

los cuencos se pueden conectar firmemente al soporte mediante un mecanismo giratorio

les bols peuvent être solidement reliés au présentoir au moyen d'un mécanisme rotatif

	Ø cm	↑ cm	ltr.	Farbe / Colour	€
84920	21,5	7/8,5	1,0		34,00
84921	21,5	7/8,5	1,0		34,00
84922	25,0	8/11	1,6		42,60
84923	25,0	8/11	1,6		42,60
84924	28,5	10/14	2,6		46,60
84925	28,5	10/14	2,6		46,60



84944 Ø 31,5 cm

84944 Ø 31,5 cm

Tablett / Platte „FRIDA LOCK“

tray
bandeja
plateau



Tablets lassen sich durch Drehmechanismus mit dem Ständer fest verbinden

trays can be firmly connected to the stand by a turning mechanism

las bandejas se pueden conectar firmemente al soporte mediante un mecanismo giratorio

les plateaux peuvent être solidement reliés au présentoir au moyen d'un mécanisme rotatif

	Ø cm	↑ cm	Farbe / Colour	€
84943	31,5	1,5/2,5		30,50
84944	31,5	1,5/2,5		30,50





Ständer „FRIDA LOCK“

stand
soporte
présentoir



	Ø cm	↑ cm	Farbe / Colour	€
84926	16,5	8	White	9,90
84927	16,5	8	Black	9,90



Ständer „FRIDA LOCK“

stand
soporte
présentoir



	Ø cm	↑ cm	Farbe / Colour	€
84928	16,5	12	White	17,00
84929	16,5	12	Black	17,00



Haube „DOME“

cover
campana
cloche



	Ø cm	↑ cm	fits to	€
06519	21	17		30,00
06520	30	22	00468, 00469, 84943, 84944	37,00
06521	36	27		74,00
	Ø cm	↑ cm	fits to	€
06525	30	40	00468, 00469, 84943, 84944	74,00



OAK LIGHT



84205 GN 1/1



84206 GN 1/2



84207 GN 1/3



84209 GN 2/4

GN Tablett „OAK LIGHT“

GN tray
GN bandeja
GN plateau



	cm	↑ cm	GN	€
84205	53,0 x 32,5	1,5	1/1	43,00
84206	32,5 x 26,5	1,5	1/2	22,00
84207	32,5 x 17,6	1,5	1/3	15,60
84209	53,0 x 16,2	1,5	2/4	25,00





GN Tablett „ZERO“

GN tray
GN bandeja
GN plateau



glatte, hochglänzende Oberfläche
smooth and shiny surface
superficie lisa con acabado brillante
surface lisse et finition brillante

	cm	↑ cm	GN	Farbe / Colour	€
84185	53,0 x 32,5	1,5	1/1		41,40
84186	32,5 x 26,5	1,5	1/2		22,40
84187	32,5 x 17,6	1,5	1/3		15,60
84188	26,5 x 16,2	1,5	1/4		12,60
84189	53,0 x 16,2	1,5	2/4		24,60

passende Hauben / suitable covers / campanas adecuadas / cloches appropriées

	cm	↑ cm	✱ mm	GN	€
11042	53,0 x 32,5	9,5	3	1/1	32,00
11041	32,5 x 26,5	9,5	3	1/2	23,00
11043	32,5 x 17,6	10,5	3	1/3	17,00
11044	53,0 x 16,2	10,5	3	2/4	23,00



GN Tablett „DRIFTWOOD“

GN tray
GN bandeja
GN plateau



die Melaminplatten (Holzoptik) haben eine leicht wellige Oberfläche und wirken optisch wie aus Holz gefertigt

the melamine trays (wood look) have a slightly wavy surface and look visually as made of natural wood

las bandejas de melamina (imitación madera) tienen una superficie ligeramente ondulada y parecen estar hechas de madera natural

les plateaux de mélamine (imitation bois) ont une surface légèrement ondulée et donnent une impression visuelle de bois naturelle

	cm	↑ cm	GN	€
84180	53,0 x 32,5	1,5	1/1	43,70
84181	32,5 x 26,5	1,5	1/2	22,40
84182	32,5 x 17,6	1,5	1/3	15,60

GN 1/1	GN 1/2	GN 1/3
	GN 1/2	GN 1/3
		GN 1/3

Oberflächenansicht
surface view

SLATE



GN Tablett „SLATE“

GN tray
GN bandeja
GN plateau



	cm	↑ cm	GN	€
83955	53,0 x 32,5	1	1/1	47,20
83956	32,5 x 26,5	1	1/2	25,00
83957	32,5 x 17,6	1	1/3	17,30
83958	26,5 x 16,2	1	1/4	13,80
83971	53,0 x 16,2	1	2/4	27,50



GN Tablett „SLATE“

GN tray
GN bandeja
GN plateau



massive Metallgriffe verchromt inkl. fest verschraubten 4 cm Distanzstücken
chrome plated handles, incl. mounted 4 cm distance pillars
asas cromadas, incluye distanciadores de 4 cm firmemente montados
poignées chromées, y compris piliers de distance montées de 4 cm

	cm	↑ cm	GN	€
83980	53 x 32,5	6	1/1	56,40



Schieferoptik
slate look

GN Tablett „SLATE“

GN tray
GN bandeja
GN plateau



	cm	↑ cm	GN	€
83981	53 x 32,5	1,5	1/1	47,40

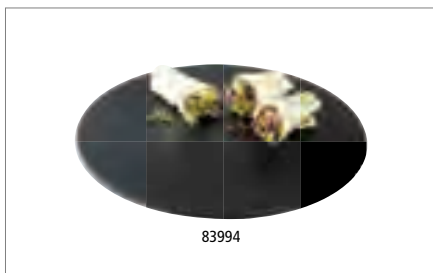

83994

Tablett „SLATE“

tray
bandeja
plateau



	Ø cm	↑ cm	€
83992	30	1	22,60
83994	40	1	35,90



11056

85099

30336

Tablett „SLATE“

tray
bandeja
plateau

passend zu Etagère 30336
suitable for 2-tier tray 30336
adecuado para soporte 2 alturas 30336
adapté à étagère 2 niveaux



	cm	↑ cm	€
85099	28,0 x 15,5	1	13,60

Haube / cover / campana / cloche

	cm	↑ cm	€
11056	26,0 x 12,0	10	6,00



84239

84244

84245

Schale „SLATE“

bowl
cuenco
bol



	cm	↑ cm	litr.	€
84239 <small>NEW</small>	12,5 x 12,5	6,5	0,4	6,80
84244	19,0 x 19,0	9,0	1,5	21,00
84245	25,0 x 25,0	12,0	3,8	36,00



SLATE ROCK



Tablett „SLATE ROCK“

tray
bandeja
plateau



Die schwarzen Melaminplatten überzeugen mit ihrem Schieferlook

The black melamine trays convince with their slate look

Las bandejas de melamina negras convencen por su aspecto de pizarra

Les plateaux en mélamine noirs convainquent grâce au aspect de l'ardoise

	cm	↑ cm	Griff / handle cm	€
84258	40 x 20	1,5	13	29,90
84259	48 x 20	1,5	13	35,90
	Ø cm	↑ cm	Griff / handle cm	€
84257	30	1,5	12	24,20

OAK



84178



84179

Tablett „OAK“

tray
bandeja
plateau

	cm	↑ cm	Griff / handle cm	€
84178	40 x 20	1,5	13	31,00
84179	48 x 20	1,5	13	38,00



Tablett „OAK“

tray
bandeja
plateau

	Ø cm	↑ cm	Griff / handle cm	€
84177	30	1,5	12	25,30



Schale „OAK“

bowl
cuenco
bol

	cm	↑ cm	VE / unit	€ / pc.
84434	11,5 x 7,0	2,5	20	4,60



PURE



83401



83479

Tablett „PURE“

tray
bandeja
plateau



	cm	↑ cm	GN	Farbe / Colour	€
83401	53,0 x 32,5	3	1/1		42,00
83433	53,0 x 16,2	3	2/4		25,00
83480	32,5 x 26,5	3	1/2		22,60
83481	32,5 x 17,6	3	1/3		17,00
83482	26,5 x 16,2	3	1/4		12,40
83597	40,0 x 30,0	3	Bäcker-Maß		32,00

	cm	↑ cm	GN	Farbe / Colour	€
83479	53,0 x 32,5	3	1/1		42,00
83434	53,0 x 16,2	3	2/4		24,00
83490	32,5 x 26,5	3	1/2		22,00
83491	32,5 x 17,6	3	1/3		17,00
83492	26,5 x 16,2	3	1/4		12,40
83592	40,0 x 30,0	3	Bäcker-Maß		32,00



83403

Tablett „PURE“

tray
bandeja
plateau



	cm	↑ cm	Farbe / Colour	€
83403	35,5 x 18,0	3		14,00
83417	30,0 x 21,0	3		16,40
83402	53,0 x 18,0	3		28,00



83405

Tablett „PURE“

tray
bandeja
plateau



	cm	↑ cm	Farbe / Colour	€
83418	18,0 x 18,0	3		8,20
83407	21,0 x 21,0	3		11,80
83406	26,5 x 26,5	3		17,90
83405	37,0 x 37,0	3		24,40



Teller „CASUAL“

plate
plato
assiette



	Ø cm	↑ cm	Farbe / Colour	€
83500	22,5	2,5		8,60
83514	26,5	2,5		10,30



Teller „PURE“

plate
plato
assiette



	Ø cm	↑ cm	Farbe / Colour	€
83884	31	2,5		21,60
83869	38	2,5		24,70



Schale „PURE“

bowl
cuenco
bol



	Ø cm	↑ cm	ltr.	Farbe / Colour	€
83450	5,5	4,0	0,02		2,00
83419	9,0	4,5	0,09		3,60
83453	13,0	6,5	0,30		7,60
83455	15,0	7,5	0,45		12,00
83415	20,0	10,5	1,25		21,60
	Ø cm	↑ cm	ltr.	Farbe / Colour	€
83451	5,5	4,0	0,02		2,00
83452	9,0	4,5	0,09		3,60
83454	13,0	6,5	0,30		7,60



Schale „PURE“

bowl
cuenco
bol



	cm	↑ cm	ltr.	Farbe / Colour	€
84424	6,5 x 6,5	3,0	0,05		2,60
83414	9,0 x 9,0	4,0	0,14		4,20
83410	12,5 x 12,5	6,5	0,40		6,80
83409	19,0 x 19,0	9,0	1,50		22,40
83408	25,0 x 25,0	12,0	3,80		36,70
84425	32,0 x 32,0	14,0	8,0		44,80
	cm	↑ cm	ltr.	Farbe / Colour	€
84426	6,5 x 6,5	3,0	0,05		2,60
83466	9,0 x 9,0	4,0	0,14		4,20
83467	12,5 x 12,5	6,5	0,40		6,80
83468	19,0 x 19,0	9,0	1,50		22,40
83469	25,0 x 25,0	12,0	3,80		36,70
84427	32,0 x 32,0	14,0	8,0		44,80



Schale „PURE COLOR“

bowl
cuenco
bol



	cm	↑ cm	ltr.	Farbe / Colour	€
85260	19 x 19	9	1,5	sand	22,40
85261	25 x 25	12	3,8	sand	36,70
	cm	↑ cm	ltr.	Farbe / Colour	€
85266	19 x 19	9	1,5	olive	22,40
85267	25 x 25	12	3,8	olive	36,70



Schale „SLATE“

bowl
cuenco
bol



	cm	↑ cm	ltr.	Farbe / Colour	€
84239 NEW	12,5 x 12,5	6,5	0,4		6,80
84244	19,0 x 19,0	9,0	1,5		21,00
84245	25,0 x 25,0	12,0	3,8		36,00



Deckel „PURE“ mit Löffelaussparung

cover with notched for spoons
tapa con espacio para la cuchara
couverture avec encoche pour la louche



	cm	↑ cm	fits to	€
83600	19 x 19	1,5	79004, 79005, 83409, 83468, 84244, 85260, 85266	8,20
83601	25 x 25	1,5	83469, 83408, 84245, 84561, 84562, 85261, 85267	10,40



Schale „PURE“

bowl
cuenco
bol



	cm	↑ cm	ltr.	€
83498	38,5 x 15,5	7,5	1,50	34,00
83499	51,0 x 15,5	7,5	2,40	44,90



Schale „APS+“

bowl
cuenco
bol



	cm	↑ cm	ltr.	Farbe / Colour	€
15215	13 x 13	7	0,6		10,40
15216	20 x 20	7	1,5		24,40
15217	24 x 24	9	3,5		36,80



GN Tablett „FRAMES“

GN tray
GN bandeja
GN plateau



	cm	↑ cm	GN	€
84046	53,0 x 32,5	2	1/1	33,00
84047	32,5 x 26,5	2	1/2	18,40
84048	32,5 x 17,6	2	1/3	12,60

84046 GN 1/1



FLOAT



- ideal für den Thekenbereich
- stapelbar mit Löffel und Deckel
- Schalenboden fixiert sich auf dem Deckel
- rutschfest (Antirutschfüßchen)

- ideal for the counter area
- stackable with spoon and lid
- the bottom of the bowl is fixed on the lid
- non-slip (with non-slip feet)

- ideal para la zona del mostrador
- apilable con cuchara y tapa
- el fondo del cuenco se fija en la tapa
- antideslizante (con pies antideslizantes)

- idéal pour l'aire de comptoir
- empilable avec cuillère et couvercle
- le fond du bol se fixe sur le couvercle
- antidérapant (avec pieds antidérapants)



Schale „FLOAT“ bowl cuenco bol



	Ø cm	↑ cm	ltr.	Farbe / Colour	VE / unit	€/ pc.
83900	5,5	3,0	0,03		36	1,80
83902	9,0	4,5	0,15			3,20
83904	13,0	6,5	0,45			7,40
83906	15,0	7,5	0,70			11,00
83908	20,5	10,0	1,90			18,20
83901	5,5	3,0	0,03		36	1,80
83903	9,0	4,5	0,15			3,20
83905	13,0	6,5	0,45			7,40
83907	15,0	7,5	0,70			11,00
83909	20,5	10,0	1,90			18,20



Schale „FLOAT“

bowl
cuenco
bol



	cm	↑ cm	ltr.	Farbe / Colour	VE / unit	€ / pc.
83910	5,5 x 5,5	3,0	0,03	White	36	1,80
83912	9,0 x 9,0	4,5	0,16	White		3,60
83914	12,5 x 12,5	6,0	0,50	White		7,00
83916	19,0 x 19,0	9,5	1,90	White		16,40
83918	25,0 x 25,0	12,0	4,70	White		30,00
83911	5,5 x 5,5	3,0	0,03	Black	36	1,80
83913	9,0 x 9,0	4,5	0,16	Black		3,60
83915	12,5 x 12,5	6,0	0,50	Black		7,00
83917	19,0 x 19,0	9,5	1,90	Black		16,40
83919	25,0 x 25,0	12,0	4,70	Black		30,00



GN Tablett „FLOAT“

GN tray
GN bandeja
GN plateau



	cm	↑ cm	GN	Farbe / Colour	€
83923	53,0 x 32,5	3	1/1	White	38,00
83925	32,5 x 26,5	3	1/2	White	23,00
83924	53,0 x 32,5	3	1/1	Black	38,00
83926	32,5 x 26,5	3	1/2	Black	23,00



Deckel „FLOAT“ mit Löffelaussparung

cover with notched for spoons
tapa con espacio para la cuchara
couverture avec encoche pour la louche



	cm	↑ cm	fits to	€
83921	19 x 19	1,3	83916, 83917	8,40
83922	25 x 25	1,3	83918, 83919	10,60



GLOBAL BUFFET

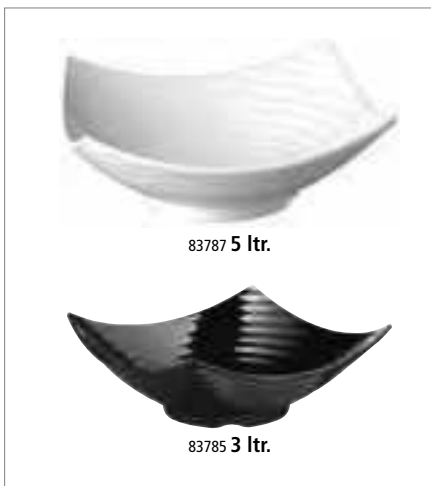

Schale „GLOBAL BUFFET“

bowl
cuenco
bol



	cm	↑ cm	ltr.	Farbe / Colour	€
83785	32,5 x 32,5	12,0	3	White	25,90
83787	40,0 x 40,0	13,5	5	White	41,90
84785	32,5 x 32,5	12,0	3	Black	25,90



Schale „GLOBAL BUFFET“

bowl
cuenco
bol



	cm	↑ cm	ltr.	Farbe / Colour	€
83799	25,5 x 25,5	13,0	3,0	White	21,00
83788	32,0 x 32,0	16,5	4,5	White	26,40
83789	35,0 x 35,0	17,0	6,0	White	32,70
83790	40,0 x 40,0	17,5	8,0	White	41,90



Schale „GLOBAL BUFFET“

bowl
cuenco
bol



	cm	↑ cm	ltr.	Farbe / Colour	€
84462	44 x 25	20	3,3	White	24,20

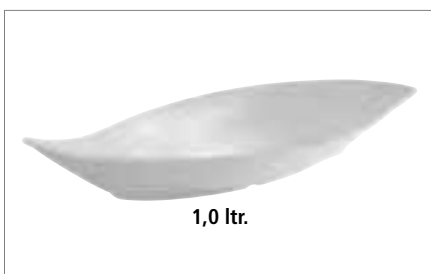

Schale „LEAF“

bowl
cuenco
bol



	cm	↑ cm	ltr.	Farbe / Colour	€
84200	42 x 19,5	6,5	1	White	13,50

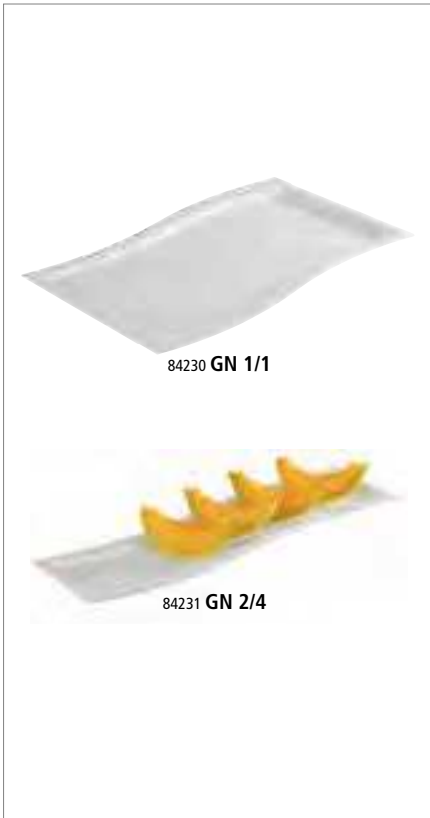

GN Tablett „SINUS“

GN tray
GN bandeja
GN plateau



	cm	↑ cm	GN	€
84230	53 x 32,5	2	1/1	33,40
84231	53 x 16,2	2	2/4	20,30



Schale „CASCADE“

bowl
cuenco
bol



	cm	↑ cm	GN	ltr.	€
83960	32,5 x 26,5	7,5	1/2	3,65	22,40
83962	26,5 x 16,2	7,5	1/4	1,50	12,70
83961	53 x 16,2	7,5	2/4	3,65	24,20



CAKEPLATES



Servier- und Tortenplatte „CASUAL“

cake plate
porta pasteles
présentoir à gâteaux



	Ø cm	↑ cm	€
83890	31	8	28,60
83891	31	16	36,00



Servier- und Tortenplatte „CASUAL“

cake plate
porta pasteles
présentoir à gâteaux



	cm	↑ cm	€
83892	31 x 31	8	32,00
83893	31 x 31	16	39,00



Torten- / Konditorplatte

cake stand
soporte para pastel
présentoir à gâteaux



Rand fixiert die Haube, mit Antirutschfüßchen

carved edge fixes the cover, with non-slip feet

ranura para fijar bien la campana, con pies antideslizantes

bord rainuré pour maintenir ferme la cloche, avec pieds antidérapants

	Ø cm	↑ cm	Farbe / Colour	€
00468	31,0	3,5	White	18,40
00469	31,0	3,5	Black	18,40



Tablett / Teller

tray / plate
bandeja / plato
plateau / assiette



	Ø cm	↑ cm	Farbe / Colour	€
83869	38	2,5	White	24,70

Rolltophaube mit verchromtem Kugelgriff

rolltop cover with chrome plated handle
campana abatible con pomo cromado
cloche basculante avec bouton chromé



	Ø cm	↑ cm	€
18388	38	20	24,00



Frischhalte-Haube

cover
campana
cloche



	Ø cm	↑ cm	€
06510	30	11,5	5,90

mit verchromtem Griff / with chrom plated handle / con botón cromado / avec bouton chromé

	Ø cm	↑ cm	€
06512	30	11,5	8,20



Schale „BALANCE“

bowl
cuenco
bol



	Ø cm	↑ cm	ltr.	Farbe / Colour	€
84040	14,5	9,0	0,4	White	6,40
84041	21,0	13,0	1,5	White	14,20
84042	24,5	15,0	2,5	White	18,40
84043	30,0	19,5	5,0	White	31,00

	Ø cm	↑ cm	ltr.	Farbe / Colour	€
85040	14,5	9,0	0,4	Black	6,40
85041	21,0	13,0	1,5	Black	14,20
85042	24,5	15,0	2,5	Black	18,40
85043	30,0	19,5	5,0	Black	31,00

Buffetständer „KING“ / buffet stand / soporte para buffet / présentoir buffet

	Ø cm	↑ cm	€
03622	15	14	44,00
03623	15	21	48,00



Fass, 2-teilig

bowl
cuenco
bol



2-teilig: Unterteil / Edelstahlschale

2 pcs.: lower part / stainless steel bowl
set de 2: parte inferior / cuenco de acero inoxidable
set de 2: partie inférieure / bol en acier inox

	Ø cm	↑ cm	€
85250	26	16	49,00

Unterteil / lower part / parte inferior / partie inférieure

	Ø cm	↑ cm	ltr.	€
85251	25	16	4,5	38,00

Edelstahlschale / stainless steel bowl / cuenco de acero inoxidable / bol en acier inox

	Ø cm	↑ cm	ltr.	€
85252	26	9	3,0	12,00

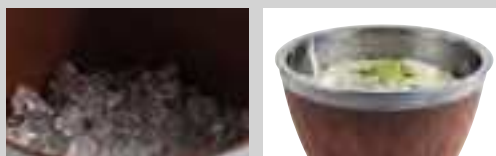

Unterteil mit Eis füllen für perfekte Kühlung sensibler Speisen
fill the bottom part with ice for perfect cooling of sensitive dishes

CASUAL



Schälchen „CASUAL MINI“

bowl
cuenco
bol mini



	cm	↑ cm	ltr.	Farbe / Colour	VE / unit	€ / pc.
83880	6,0	2,5	0,02	White	24	2,10
83881	7,5	3,5	0,05	White	24	2,60



Schale „CASUAL MAXI“

bowl
cuenco
bol



	Ø cm	↑ cm	ltr.	Farbe / Colour	€
83696	10	4,5	0,15	White	3,50
83698	12	5,5	0,25	White	4,20
83700	14	6,5	0,50	White	4,90
83704	20	9,2	1,80	White	10,40
83702	23	10,5	2,50	White	11,80
	Ø cm	↑ cm	ltr.	Farbe / Colour	€
83697	10	4,5	0,15	Black	3,50
83699	12	5,5	0,25	Black	4,20
83701	14	6,5	0,50	Black	4,90
83705	20	9,2	1,80	Black	10,40
83703	23	10,5	2,50	Black	11,80



Schale „CASUAL“

bowl
cuenco
bol



	cm	↑ cm	ltr.	Farbe / Colour	€
84221	26,5 x 10,5	6,5	1,0	White	11,80



Schale „CASUAL“

bowl
cuenco
bol

	Ø cm	↑ cm	ltr.	Farbe / Colour	€
84215	10	6,5 / 8,5	0,2	—	5,90
84216	12	7,5 / 9,5	0,3	—	7,50



Schale „CASUAL“

bowl
cuenco
bol

	Ø cm	↑ cm	ltr.	Farbe / Colour	€
84295	10	7	0,13	—	3,40



Dipschale „CASUAL“

dip tray
bandeja para dips
plateau pour dips

	cm	↑ cm	Farbe / Colour	€
84220	29 x 9	3	—	8,00



Dipschälchen „CASUAL“

dip bowl
cuenco para dip
ramequin

	Ø cm	↑ cm	ltr.	Farbe / Colour	VE / unit	€ / pc.
83780	6,0	4,0	0,05	—	24	1,20
83781	7,5	4,0	0,07	—	24	1,50
83782	8,0	4,5	0,08	—	24	1,90
83783	8,5	4,5	0,12	—	24	2,00
83798	6,0	4,0	0,05	—	24	1,40
83777	6,0	3,5	0,04	—	24	1,40



Dipschälchen „FLOWER POT“
dip bowl
cuenco para dip
ramequin



	Ø cm	↑ cm	ltr.	Farbe / Colour	VE / unit	€ / pc.
84470	6,0	3,5	0,04		60	1,80
84471	6,0	3,5	0,04		60	1,80
84472	6,0	3,5	0,04		60	1,80



Dipschälchen, 6er Set
dip bowl, 6 pcs.
cuenco para dip, set de 6
ramequin, set de 6

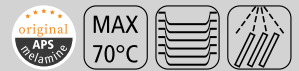

	Ø cm	↑ cm	ltr.	Farbe / Colour	pcs.	€ / set
85240	6	4	0,04		6	10,40
85241	6	4	0,04		6	10,40
85242	6	4	0,04		6	10,40
85243	6	4	0,04		6	10,40
85244	6	4	0,04		6	10,40



Schale „MINI“
bowl
cuenco
bol



	cm	↑ cm	ltr.	Farbe / Colour	VE / unit	€ / pc.
84750	8 x 8	3	0,06		24	3,50

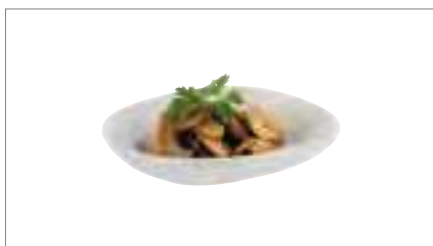

Teller „MINI“

plate
plato
assiette



	cm	↑ cm	ltr.	VE / unit	€ / pc.
84444	10,5 x 8,5	2,0	0,07	20	3,70



Schale „MINI“

bowl
cuenco
bol



	cm	↑ cm	ltr.	VE / unit	€ / pc.
84445	10,5 x 6,0	4,0	0,07	20	3,70
84446	13,5 x 7,5	3,0	0,07	20	3,70
84448	9,5 x 9,0	5,5	0,09	20	3,70
84449	13,0 x 12,0	7,5	0,18	20	5,00



Schale „MINI“

bowl
cuenco
bol



	cm	↑ cm	ltr.	VE / unit	€ / pc.
84452	11,5 x 7,5	3,0	0,06	24	2,10
84454	11,5 x 6,0	5,5	0,04	24	2,10
84456	8,5 x 7,0	6,0	0,07	24	2,10
84458	8,0 x 8,0	4,0	0,10	24	2,10
84450	7,5 x 7,0	4,5	0,05	24	2,10



Schale „MINI“
bowl
cuenco
bol



	Ø cm	↑ cm	ltr.	VE / unit	Farbe / Colour	€ / pc.
84775	8,5	2,5	0,07	60		3,20
84778	8,5	2,5	0,07	60		3,20
84781	8,5	2,5	0,07	60		3,20



Schale „MINI“
bowl
cuenco
bol



	Ø cm	↑ cm	ltr.	VE / unit	Farbe / Colour	€ / pc.
84776	8,5	2,5	0,07	48		3,20
84779	8,5	2,5	0,07	48		3,20
84782	8,5	2,5	0,07	48		3,20



Schale „MINI“
bowl
cuenco
bol



	cm	↑ cm	ltr.	VE / unit	Farbe / Colour	€ / pc.
84777	9,5 x 5,5	5,5	0,07	48		3,20
84780	9,5 x 5,5	5,5	0,07	48		3,20
84783	9,5 x 5,5	5,5	0,07	48		3,20



Schale „HALFTONE“
bowl
cuenco
bol



	Ø cm	↑ cm	ltr.	VE / unit	€ / pc.
84217	8,0	4	0,1	12	4,00



Dipschälchen „GOURMET“
dip bowl
cuenco para dip
ramequin



	Ø cm	↑ cm	ltr.	VE / unit	€ / pc.
84018	7	6	0,05	20	2,60



Besteckablage „SMALL WAVE“

cutlery rest
reposa cuchara
pose-cuillère



	cm	↑ cm	€
83897	26 x 13	4,5	10,90



Besteckablage „BOWL“

cutlery rest
reposa cuchara
pose-cuillère



	cm	↑ cm	ltr.	€
83803	22,5 x 11	6	0,5	7,80



Besteckablage „SPOON“

cutlery rest
reposa cuchara
pose-cuillère



	cm	↑ cm	€
83801	26 x 10,5	5	7,40



Servierlöffel „PROFI“

serving spoon
cuchara para servir
cuillère de service



	cm	→ cm	Farbe / Colour	€
84020	7 x 6,5	26,5		5,80
84021	7 x 6,5	26,5		5,80



Salatlöffel

salad spoon
cuchara para ensalada
cuillère à salade



	cm	→ cm	€
84035	8 x 7	24	2,40

FINGERFOODLÖFFEL



Fingerfoodlöffel „HALFTONE“
party spoon
cuchara party
cuillère party



	∅ cm	↑ cm	VE / unit	€ / pc.
84158	5,5	7	24	3,70



Fingerfoodlöffel „HALFTONE“
party spoon
cuchara party
cuillère party



	cm	↑ cm	VE / unit	€ / pc.
84128	14,5 x 4,5	4,5	12	3,70



Fingerfoodlöffel „LEAF“
party spoon
cuchara party
cuillère party



	cm	↑ cm	Farbe / Colour	VE / unit	€ / pc.
83889	10 x 4,5	1,5		50	2,20
83887	10 x 4,5	1,5		50	2,20
83888	10 x 4,5	1,5		50	2,20





Fingerfoodlöffel „HONG KONG“

party spoon
cuchara party
cuillère party



	cm	↑ cm	Farbe / Colour	VE / unit	€ / pc.
83486	13 x 4,5	4,5		60	1,50
83487	13 x 4,5	4,5		60	1,50

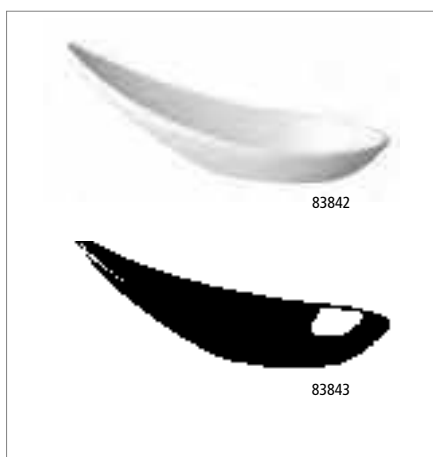

Fingerfoodlöffel „MING HING“

party spoon
cuchara party
cuillère party



	cm	↑ cm	Farbe / Colour	VE / unit	€ / pc.
83842	11 x 4,5	4		60	1,40
83843	11 x 4,5	4		60	1,40



Schale „MINI“

bowl
cuenco
bol



	cm	↑ cm	ltr.	VE / unit	€ / pc.
84460	35 x 4,5	3	0,20	10	3,30



Schale, rund „TAO“

bowl, round
cuenco, redondo
bol, rond



	cm	↑ cm	ltr.	Farbe / Colour	€
83648	10,5 x 10,0	6,5 / 3,0	0,07		4,20
83649	10,5 x 10,0	6,5 / 3,0	0,07		4,20

FLYING BUFFET

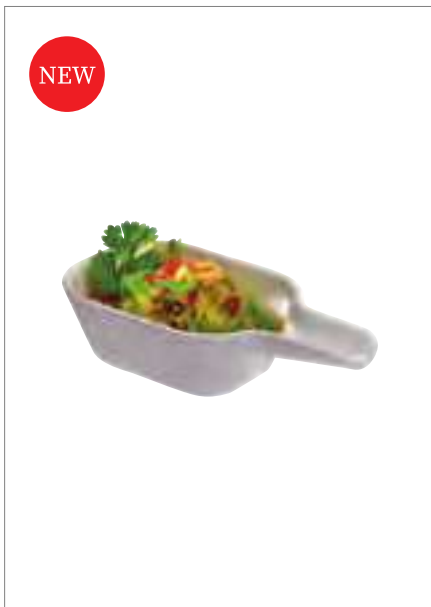

Schale „TASTE“

bowl
cuenco
bol



ideal für das Flying Buffet, inklusive Löffelablage

ideal for the flying buffet, including spoon tray

ideal para el flying buffet, con asa porta cuchara

idéal pour le flying buffet, avec support pour cuillère

	cm	↑ cm	ltr.	Farbe / Colour	€
84455	13,5 x 7,5	4	0,05	white	4,00



Fingerfood-Teller „FLYING BUFFET“

fingerfood plate
plato para el aperitivo
assiette pour apéritif



	cm	↑ cm	Farbe / Colour	VE / unit	€ / pc.
83878	9,5 x 9,5	1,5 / 3,5	white	24	4,00
83879	9,5 x 9,5	1,5 / 3,5	black	24	4,00



Schale „FLOAT“

bowl
cuenco
bol



	cm	↑ cm	Farbe / Colour	€
83912	9 x 9	4,5	White	3,60
83913	9 x 9	4,5	Black	3,60



GN Tablett „APART“

GN tray
GN bandeja
GN plateau

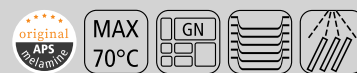

	cm	↑ cm	GN	€
83828	53 x 32,5	2,5	1/1	38,50
83830	32,5 x 26,5	2,5	1/2	21,40



GN Edelstahl Tablett

GN stainless steel platter
GN bandeja de acero inoxidable
GN plateau en acier inox



	cm	GN	€
11119	53 x 32,5	1/1	33,00

EGG HOLDERS



Eierbecher, 4er Set „EGGY“

egg holder, 4 pcs. set
huevera, set de 4
coquetier, set de 4



	Ø cm	↑ cm	pcs.	Farbe / Colour	€/ set
85295 <small>NEW</small>	8,5	2	4	green matt	8,40
85296 <small>NEW</small>	8,5	2	4	grey matt	8,40
83849	8,5	2	4	black matt	8,40
83848	8,5	2	4	white shiny	8,40



Eierbecher, 4er Set

egg holder, 4 pcs. set
huevera, set de 4
coquetier, set de 4



	Ø cm	↑ cm	pcs.	Farbe / Colour	€/ set
83851	8	3	4	white shiny	8,60

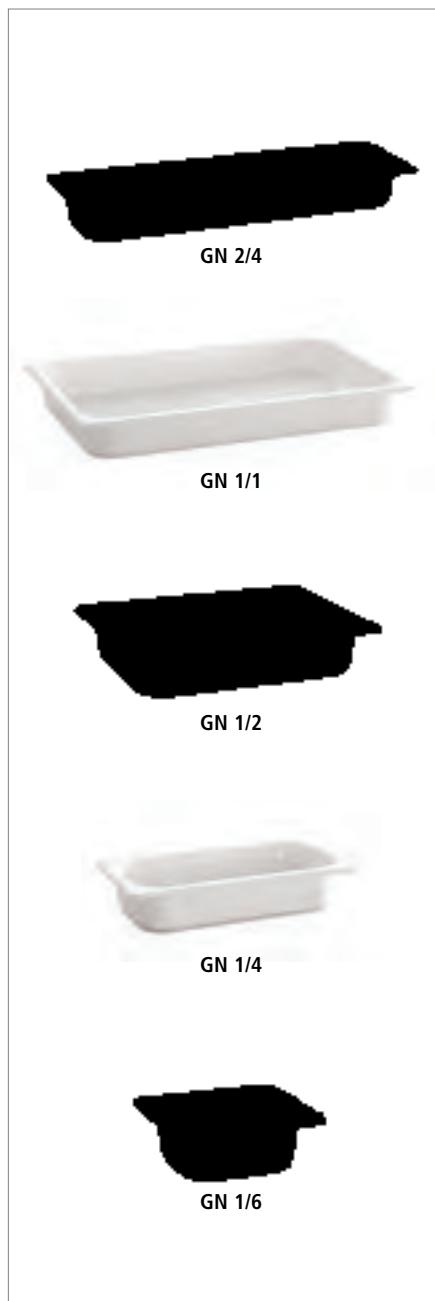

GN 2/4

GN 1/1

GN 1/2

GN 1/4

GN 1/6

GN-Behälter „ECOLINE“

GN container

GN cubeta

GN bac

mit Stapelnocke

with notching edge

con borde marcado para el apilado

avec rebord pour l'empilage



	GN	↓ mm	litr.	cm	Farbe / Colour	€
83759	1/1	65	7,10	53,0 x 32,5		32,60
83755	2/4	65	3,00	53,0 x 16,2		22,00
83757	1/2	65	3,40	32,5 x 26,5		18,60
83753	1/3	65	2,00	32,5 x 17,6		16,00
83751	1/4	65	1,35	26,5 x 16,2		14,20
83749	1/6	65	0,80	17,6 x 16,2		11,20

	GN	↓ mm	litr.	cm	Farbe / Colour	€
83758	1/1	65	7,10	53,0 x 32,5		32,60
83754	2/4	65	3,00	53,0 x 16,2		22,00
83756	1/2	65	3,40	32,5 x 26,5		18,60
83752	1/3	65	2,00	32,5 x 17,6		16,00
83750	1/4	65	1,35	26,5 x 16,2		14,20
83748	1/6	65	0,80	17,6 x 16,2		11,20

	GN	↓ mm	litr.	cm	Farbe / Colour	€
84300	1/1	100	10,6	53,0 x 32,5		38,00
84302	2/4	100	4,3	53,0 x 16,2		27,40
84301	1/2	100	4,7	32,5 x 26,5		22,60
84303	1/3	100	2,7	32,5 x 17,6		18,40
84304	1/4	100	1,9	26,5 x 16,2		16,00
84305	1/6	100	1,0	17,6 x 16,2		12,20

	GN	↓ mm	litr.	cm	Farbe / Colour	€
84306	1/1	100	10,6	53,0 x 32,5		38,00
84308	2/4	100	4,3	53,0 x 16,2		27,40
84307	1/2	100	4,7	32,5 x 26,5		22,60
84309	1/3	100	2,7	32,5 x 17,6		18,40
84310	1/4	100	1,9	26,5 x 16,2		16,00
84311	1/6	100	1,0	17,6 x 16,2		12,20



GN-Deckel

GN-lid

GN tapa

GN couvercle



	GN	cm	€
82001	1/1	53,0 x 32,5	11,60
82013	1/2	32,5 x 26,5	6,70
82019	1/3	32,5 x 17,6	5,30
82029	1/4	26,5 x 16,2	4,30
82037	1/6	17,6 x 16,2	3,30





Tableware & Table Presentation

ALLURE.....	324
CRAFT.....	275
CUTLERY BINS.....	350
DIP BOWLS.....	278
EGG HOLDERS.....	323
ENAMELWARE.....	284
FLOW.....	325
GRAVY BOATS.....	326
LEVANTE.....	282
MENAGES.....	302
MENU HOLDERS.....	342
MILLS.....	310
MUMBAI.....	270
PEBBLES.....	281
PLACEMATS.....	330
SERVING BOARDS WOOD.....	291
SERVING TROWELS.....	277
SIMPLY WOOD.....	297
SNACKCAN.....	274
SNACKHOLDERS.....	272
TABLE CADDYS.....	320
TABLE LAMPS.....	356
VALUMO.....	382
VINTARA.....	268
WASTE BINS.....	355
WECK.....	286

VINTARA



Stielkasserolle / Serviertopf „VINTARA“

saucepan / serving pot
cacerola / olla
casserole à manche / marmite

Vintage-Look



	Ø cm	↑ cm	ltr.	Griff / handle cm	€
40780	5,5	2,5	0,05	5	7,20



Stielkasserolle / Serviertopf „VINTARA“

saucepan / serving pot
cacerola / olla
casserole à manche / marmite

Vintage-Look



	Ø cm	↑ cm	ltr.	Griff / handle cm	€
40781	7	3,5	0,12	7,5	12,00



Stielkasserolle / Serviertopf „VINTARA“

saucepan / serving pot
cacerola / olla
casserole à manche / marmite

Vintage-Look



	Ø cm	↑ cm	ltr.	Griff / handle cm	€
40782	9,5	5,5	0,3	7	16,00



Stielkasserolle / Serviertopf „VINTARA“

saucepan / serving pot
cacerola / olla
casserole à manche / marmite



Vintage-Look

	Ø cm	↑ cm	ltr.	Griff / handle cm	€
40783	14	4	0,4	10	18,00

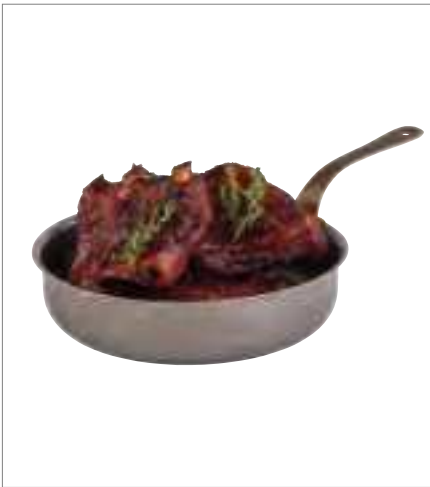

Stielkasserolle / Serviertopf „VINTARA“

saucepan / serving pot
cacerola / olla
casserole à manche / marmite



Vintage-Look

	Ø cm	↑ cm	ltr.	Griff / handle cm	€
40784	18,5	4,5	0,9	10,5	21,00

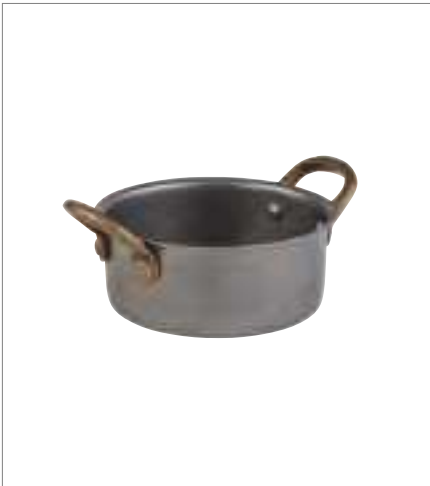

Serviertopf „VINTARA“

serving pot
olla
marmite



Vintage-Look

	Ø cm	↑ cm	ltr.	Griff / handle cm	€
40785	11,5	5	0,35	2	17,00

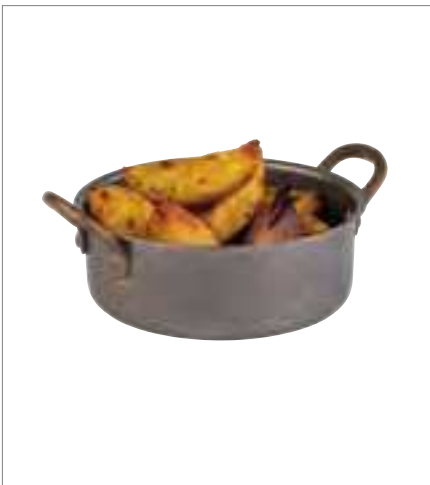

Serviertopf „VINTARA“

serving pot
olla
marmite



Vintage-Look

	Ø cm	↑ cm	ltr.	Griff / handle cm	€
40786	14	5	0,55	2	19,00



MUMBAI



40730 **0,30 ltr.**



40731 **0,35 ltr.**



40732 **0,60 ltr.**

Serviertöpfchen „MUMBAI“

small serving pot
olla pequeña de servir
marmite petite de servir



Edelstahl, außen: Kupfer-Look, gehämmert, Griffe vergoldet

stainless steel, outside: copper look, hammered, handles gold-plated

acero inoxidable, exterior: look cobre, martillada, asas doradas

acier inox, extérieur: look cuivre, martelée, poignées dorées

	Ø cm	↑ cm	ltr.	Griff / handle cm	€
40730	9,0	5,5	0,30	2,25	14,40
40731	11,5	4,5	0,35	2,00	14,40
40732	11,5	7,0	0,60	2,25	16,50
40733	14,0	5,0	0,50	1,75	15,40
40734	16,0	5,0	0,70	1,75	16,50



40735 **0,25 ltr.**



40736 **0,45 ltr.**

Mini-Servierpfanne „MUMBAI“

small serving pan
olla pequeña de servir
marmite petite de servir



Edelstahl, außen: Kupfer-Look, gehämmert, Griffe vergoldet

stainless steel, outside: copper look, hammered, handles gold-plated

acero inoxidable, exterior: look cobre, martillada, asas doradas

acier inox, extérieur: look cuivre, martelée, poignées dorées

	cm	↑ cm	ltr.	Griff / handle cm	€
40735	12,5 x 8,5	4,0	0,25	2,0	15,40
40736	14,5 x 9,5	4,5	0,45	2,0	16,50



40737 **0,15 ltr.**



40738 **0,20 ltr.**

Schale „MUMBAI“

bowl
cuenco
bol



Edelstahl, außen: Kupfer-Look, gehämmert, Griffe vergoldet

stainless steel, outside: copper look, hammered, handles gold-plated

acero inoxidable, exterior: look cobre, martillada, asas doradas

acier inox, extérieur: look cuivre, martelée, poignées dorées

	Ø cm	↑ cm	ltr.	€
40737	8,5	4,5	0,15	6,40
40738	9,0	5,0	0,20	7,80



40740 0,6 ltr.



40741 0,3 ltr.



40742 0,5 ltr.

Serviertöpfchen „CASTORO“

small serving pot
olla pequeña de servir
marmite petite de servir

Aluminium anthrazit, Griffe aus Messing

aluminium anthracite, brass handles

aluminio antracita, asas de latón

aluminium anthracite, poignées en laiton



	Ø cm	↑ cm	ltr.	Griff / handle cm	€
40740	11,5	9,5	0,6	2,5	26,00
40741	13,5	5,0	0,3	3,5	24,00
40742	15,0	6,0	0,5	2,5	25,00

**Mini-Servierpfanne**

mini pan
sartén en formato mini
poêle à frire mini



	cm	↑ cm	ltr.	€
40660	14,5 x 9,5	4,5 / 6,5	0,5	10,00



40186 0,30 ltr.



40187 0,55 ltr.



40188 0,75 ltr.

Serviertöpfchen „MUMBAI“

small serving pot
olla pequeña de servir
marmite petite de servir

gehämmert

hammered

martillada

martelée



	Ø cm	↑ cm	ltr.	Griff / handle cm	€
40186	9,5	5,5	0,30	2,5	8,60
40187	13,5	5,0	0,55	3,0	9,80
40188	15,5	5,0	0,75	3,0	11,60



40642 0,05 ltr.



40643 0,12 ltr.



40644 0,32 ltr.

Stielkasserolle / Serviertopf „POLARIS“

sauté pan / mini sauce pan
cazo recto bajo
plat à sauter

hochglanzpoliert

mirror polished

pulido brillante

poli brillant



	Ø cm	↑ cm	ltr.	Griff / handle cm	VE / unit	€/ pc.
40642	5,5	2,5	0,05	6	6	4,90
40643	7,0	3,5	0,12	8,5	6	5,50
40644	9,5	5,5	0,32	8,5	6	8,70

SNACKHOLDER



Servier-Frittierkorb „SNACKHOLDER“
 stainless steel fry baskets
 cestitas inox para el servicio mesa
 paniers inox pour le service sur table



	Ø cm	↑ cm	Griff / handle cm	Farbe / Colour		€
40600	8	7,5	9,5		stainless steel	9,00
40602	8	7,5	9,5		copper	11,40
40624	8	7,5	9,5		black mat	11,40
40601	9	8,5	9,0		stainless steel	11,20
40603	9	8,5	9,0		copper	13,00
40625	9	8,5	9,0		black mat	13,60



Servier-Frittierkorb „SNACKHOLDER“
 stainless steel fry baskets
 cestitas inox para el servicio mesa
 paniers inox pour le service sur table



	cm	↑ cm	Griff / handle cm	Farbe / Colour		€
40610	21,5 x 10,5	4,5	9,5		stainless steel	15,00
40612	21,5 x 10,5	4,5	9,5		copper	17,60
40628	21,5 x 10,5	4,5	9,5		black mat	17,60
40611	26,0 x 13,0	5,0	9,0		stainless steel	17,60
40613	26,0 x 13,0	5,0	9,0		copper	20,40
40629	26,0 x 13,0	5,0	9,0		black mat	20,40



Servier-Frittierkorb „SNACKHOLDER“
 stainless steel fry baskets
 cestitas inox para el servicio mesa
 paniers inox pour le service sur table



	cm	↑ cm	Griff / handle cm	Farbe / Colour		€
40620	10,0 x 8,5	6,5	9,0		stainless steel	12,00
40622	10,0 x 8,5	6,5	9,0		copper	15,80
40626	10,0 x 8,5	6,5	9,0		black mat	15,80
40621	13,0 x 10,5	9,0	13,5		stainless steel	15,80
40623	13,0 x 10,5	9,0	13,5		copper	19,40
40627	13,0 x 10,5	9,0	13,5		black mat	19,40



Schale „TASCA“
bowl
cuenco
bol



	Ø cm	↑ cm	ltr.	Farbe / Colour	€
40606	8,5	8,5	0,35	stainless steel	4,20
40617	8,5	8,5	0,35	stainless copper	4,80
40607	8,5	8,5	0,35	hammered	4,60
40618	8,5	8,5	0,35	hammered	5,40
40605	9,5	8,5 / 11,5	0,45	stainless steel	5,80
40616	9,5	8,5 / 11,5	0,45	stainless copper	6,50



Schale „LEVANTE“
bowl
cuenco
bol



	Ø cm	↑ cm	ltr.	Farbe / Colour	€
40710	8,5	8,5	0,40	dark red	8,00
40711	8,5	8,5	0,40	dark blue/black	8,00



Servierbrett „OAK“
serving board
tabla de servir
planche de service



aus geöltem Eichenholz, Safrille, Ø 9,5 cm Aussparung
made of oiled oak, with juice groove, with hole Ø 9.5 cm
de madera de roble aceitada, con ranura para líquidos, con agujero Ø 9,5 cm
en bois chêne huilé, avec rigole, avec trou Ø 9,5 cm

	cm	↑ cm	€
00808	37 x 25	2	31,00



mit Safrille
with juice groove

SNACKCAN



40654 0,12 ltr.



40656 0,35 ltr.



40659 0,80 ltr.



40657 1,30 ltr.



40658 1,80 ltr.

Schale „SNACKCAN“

bowl
cuenco
bol

matt poliert
matt polished
pulido mate
poli mat



	Ø cm	↑ cm	ltr.		€
40654	6,5	4,0	0,12	ideale Beilagen Größe	2,70
40655	7,5	5,5	0,17		3,20
40656	7,5	10,0	0,35		4,00
40659	12,0	8,0	0,80		7,40
40658	13,5	14,0	1,80		9,90
40657	13,5	10,5	1,30		9,00

Wachspapier „SNACKHOLDER“ / greaseproof paper squares
papel alimenticio para cucurucho / papier alimentaire pour cornet

	cm	pcs.	Motiv:	Zeitung	€
40670	42 x 25	500			59,00



Präsentationsmöglichkeit
presentation example

CRAFT



40690 0,7 ltr.



40691 0,7 ltr.



40692 0,7 ltr.



40693 1,4 ltr.



40694 1,4 ltr.



40695 1,4 ltr.

Schale „CRAFT“

bowl
cuenco
bolgehämmert
hammered
martillada
martelée

	Ø cm	↑ cm	ltr.	Farbe / Colour	€
40690	15,5 x 12,0	5,5	0,7	gold-look	14,00
40691	15,5 x 12,0	5,5	0,7	copper-look	14,00
40692	15,5 x 12,0	5,5	0,7	gunmetal-look	14,00
40693	23,0 x 15,5	6,0	1,4	gold-look	21,00
40694	23,0 x 15,5	6,0	1,4	copper-look	21,00
40695	23,0 x 15,5	6,0	1,4	gunmetal-look	21,00

SERVING TROWELS



40680

40681

Servierkelle „BOB“

serving trowel
paleta para servir
truelle de service



Edelstahl Servierkelle mit schwarzem Holzgriff

stainless steel serving trowel with black wooden handle

paleta para servir de acero inoxidable con mango de madera negra

truelle de service en acier inox avec manche en bois noir

	cm	↑ cm	Griff / handle cm	Farbe / Colour	€
40680	23,5 x 15,5	12,5	13,5		16,90
40681	23,5 x 15,5	12,5	13,5		16,90

Snackbox „INDUSTRIAL“

snack box
caja tentempié
casse-croûte



	cm	↑ cm	ltr.	€
40676	23,0 x 15,5	13	2,4	15,20



stapelbar
stackable



40604



83781

Servierbeispiel - Lieferung ohne Schälchen
delivery without bowls

Servierkorb „BURGER & FRIES“

serving basket
cesta para servir
corbeille de service



Servierkorb aus Metall mit 2 Haltern für Dipschälchen

metal serving basket with 2 holders for dip bowls
cesta de metal para servir con 2 soportes para cuencos para dip
corbeille de service en métal avec 2 supports pour ramequins

	cm	↑ cm	€
40604	39,5 x 20	11	10,00

passende Schälchen / suitable bowls / cuencos adecuados / bols appropriés



	ø cm	↑ cm	ltr.	VE / unit	€ / pc.
83781	7,5	4	0,07	24	1,50



Präsentationsmöglichkeit
presentation example



40630
4 pcs. set



40631

Servier- / Saucen-Eimer

mini stainless steel bucket
cubo inox en formato mini
seau mini inox



hochglanzpoliert
mirror polished
pulido brillante
poli brillant

	Ø cm	↑ cm	ltr.	pcs.	€
40630	7	6,5	0,15	4	13,40
40631	9	8,5	0,33	1	4,80



40685 0,05 ltr.



40686 0,17 ltr.

Schale

bowl
cuenco
bol
hochglanzpoliert
mirror polished
pulido brillante
poli brillant



	Ø cm	↑ cm	ltr.	VE / unit	€ / pc.
40685	6	3,0	0,05	24	2,40
40686	8	4,5	0,17	24	3,60



0,15 ltr.

Schale "MUMBAI"

bowl
cuenco
bol
gehämmert
hammered
martillada
martelée



	Ø cm	↑ cm	ltr.	VE / unit	€ / pc.
40185	9,5	3	0,15	24	4,00

DIP BOWLS



40724



40725



40726



40727



40729

Dipschälchen, 6er Set
 dip bowl, 6 pcs.
 cuenco para dip, set de 6
 ramequin, set de 6



	Ø cm	↑ cm	ltr.	Farbe / Colour	pcs.	€ / set
40724	6	4,5	0,06		6	17,80
40725	6	4,5	0,06		6	22,00
40726	6	4,5	0,06		6	16,00
40727	6	4,5	0,06		6	16,00
40729	6	4,5	0,06		6	16,60



Dipschälchen, 6er Set
 dip bowl, 6 pcs.
 cuenco para dip, set de 6
 ramequin, set de 6



	Ø cm	↑ cm	ltr.	Farbe / Colour	pcs.	€ / set
40720	6	2,5	0,04		6	16,60
40721	6	2,5	0,04		6	20,80
40722	6	2,5	0,04		6	15,00
40723	6	2,5	0,04		6	15,00
40728	6	2,5	0,04		6	15,50

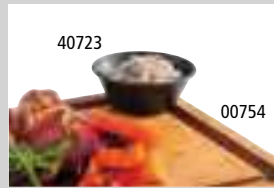

Präsentationsmöglichkeit
 presentation example



Dipschälchen, 6er Set
 dip bowl, 6 pcs.
 cuenco para dip, set de 6
 ramequin, set de 6



	Ø cm	↑ cm	ltr.	Farbe / Colour	pcs.	€ / set
85240	6	4	0,04		6	10,40
85241	6	4	0,04		6	10,40
85242	6	4	0,04		6	10,40
85243	6	4	0,04		6	10,40
85244	6	4	0,04		6	10,40

DIP BOWLS



Dipschälchen „FLOWER POT“

dip bowl
cuenco para dip
ramequin



	Ø cm	↑ cm	ltr.	Farbe / Colour	VE / unit	€/ pc.
84470	6	3,5	0,04		60	1,80
84471	6	3,5	0,04		60	1,80
84472	6	3,5	0,04		60	1,80



Dipschälchen „CASUAL“

dip bowl
cuenco para dip
ramequin



	Ø cm	↑ cm	ltr.	Farbe / Colour	VE / unit	€/ pc.
83780	6,0	4,0	0,05		24	1,20
83781	7,5	4,0	0,07		24	1,50
83782	8,0	4,5	0,08		24	1,90
83783	8,5	4,5	0,12		24	2,00
83798	6,0	4,0	0,05		24	1,40
83777	6,0	3,5	0,04		24	1,40



Dipschälchen „GOURMET“

dip bowl
cuenco para dip
ramequin



	Ø cm	↑ cm	ltr.	Farbe / Colour	VE / unit	€/ pc.
84018	7	6	0,05		20	2,60

PEBBLES



Schale, 4er Set „PEBBLES“

bowl, 4 pcs.
cuenco, set de 4
bol, set de 4



	cm	↑ cm	Farbe / Colour	pcs.	€ / set
40790	6,5 x 6	2,5	copper look	4	18,00
40791	6,5 x 6	2,5	gunmetal look	4	18,00



PVD-beschichteter Edelstahl
PVD coated stainless steel



Teller, 4er Set „PEBBLES“

plate, 4 pcs.
plato, set de 4
assiette, set de 4



	cm	↑ cm	Farbe / Colour	pcs.	€ / set
40792	8,5 x 8	1	copper look	4	18,00
40793	8,5 x 8	1	gunmetal look	4	18,00

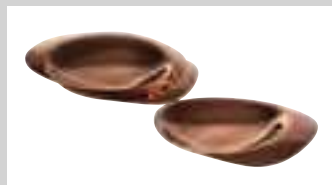

PVD-beschichteter Edelstahl
PVD coated stainless steel



Teller, 4er Set „PEBBLES“

plate, 4 pcs.
plato, set de 4
assiette, set de 4



	cm	↑ cm	Farbe / Colour	pcs.	€ / set
40794	9 x 9	1	copper look	4	18,00
40795	9 x 9	1	gunmetal look	4	18,00



PVD-beschichteter Edelstahl
PVD coated stainless steel

LEVANTE

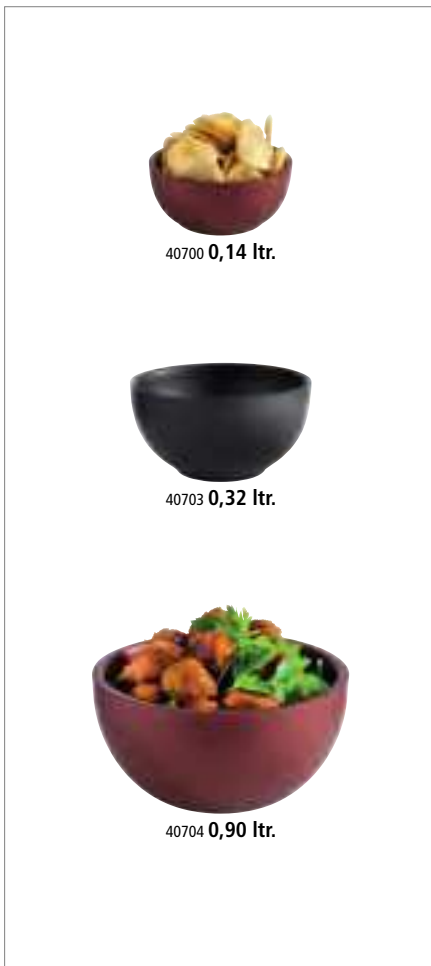

Schale „LEVANTE“

bowl
cuenco
bol



	Ø cm	↑ cm	ltr.	Farbe / Colour	€
40700	9,5	4,5	0,14		8,00
40701	9,5	4,5	0,14		8,00
40702	12	6,5	0,32		12,40
40703	12	6,5	0,32		12,40
40704	17	8,5	0,90		19,00
40705	17	8,5	0,90		19,00

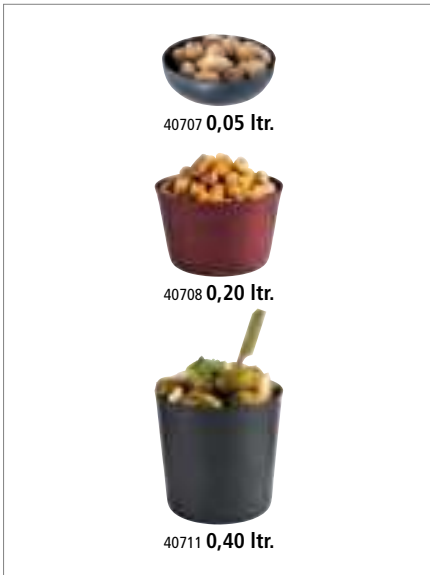

Schale „LEVANTE“

bowl
cuenco
bol



	Ø cm	↑ cm	ltr.	Farbe / Colour	€
40706	7,5	2,5	0,05		4,90
40707	7,5	2,5	0,05		4,90
40708	8,5	5,5	0,20		7,40
40709	8,5	5,5	0,20		7,40
40710	8,5	8,5	0,40		8,00
40711	8,5	8,5	0,40		8,00



Dipschälchen, 6er Set „LEVANTE“

dip bowl, 6 pcs.
cuenco para dip, set de 6
ramequin, set de 6



	Ø cm	↑ cm	ltr.	Farbe / Colour	pcs.	€ / set
40722	6	2,5	0,04		6	15,00
40723	6	2,5	0,04		6	15,00



Präsentationsmöglichkeit
presentation example



Dipschälchen, 6er Set „LEVANTE“

dip bowl, 6 pcs.
cuenco para dip, set de 6
ramequin, set de 6



	Ø cm	↑ cm	ltr.	Farbe / Colour	pcs.	€ / set
40726	6	4,5	0,06		6	16,00
40727	6	4,5	0,06		6	16,00



Flaschenkühler „LEVANTE“

bottle cooler
enfriador de botella
rafraîchisseur de bouteille

doppelwandig für beste Isolierung
double wall cooler keeps the temperature for a long time
doble pared para mantener el frio largo tiempo
double paroi pour une meilleure conservation de la température

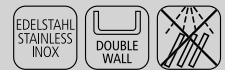

	cm	↑ cm	Farbe / Colour	€
36125	12 / 10	20		24,00
36127	12 / 10	20		24,00

ENAMELWARE



Henkelbecher „ENAMELWARE“
beaker
vaso coctelero
bol mélangeur



	Ø cm	↑ cm	ltr.	€
40636	7	5	0,10	6,00
40632	9	8	0,35	7,20



Schale „ENAMELWARE“
bowl
cuenco
bol



	Ø cm	↑ cm	ltr.	VE / unit	€ / pc.
40645	7	4,5	0,08	12	4,90
40646	8	3,5	0,08	12	4,90



Schale „ENAMELWARE“
bowl
cuenco
bol



	Ø cm	↑ cm	ltr.	€
40638	13,0	6,0	0,50	7,40
40647	16,5	4,5	0,45	6,20

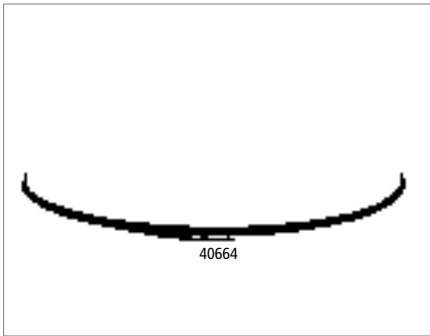

Teller, flach „ENAMELWARE“

plate, flat
plato, plano
assiette, plat



	Ø cm	↑ cm	€
40664	20	2	6,60
40665	24	2	7,80
40666	26	2	7,90



Teller, tief „ENAMELWARE“

plate, deep
plato, profunda
assiette, profonde



	Ø cm	↑ cm	ltr.	€
40661	18	3,5	0,35	8,00
40662	22	3,5	0,60	8,80
40663	24	3,5	0,85	9,80



Schale „ENAMELWARE“

bowl
cuenco
bol



	cm	↑ cm	ltr.	€
40667	16 x 12,0	3,5	0,20	7,90
40668	18 x 13,5	4,0	0,35	8,60



Schale „ENAMELWARE“

bowl
cuenco
bol



	cm	↑ cm	ltr.	€
40669	28 x 23	4,5	1,9	14,20



Original WECK



Weck-Flaschen, 6er Set

Weck-bottles, 6 pcs.
Weck-botellas, set de 6
Weck-bouteilles, set de 6



6 Flaschen + 6 Deckel, ideal zum Servieren von Säften, Smoothies, Dressings und Saucen

6 bottles + 6 covers, ideal for serving juices, smoothies, dressings and sauces

6 botellas + 6 tapas, ideal para servir zumos, batidos, aliños y salsas

6 bouteilles + 6 couvercles, idéal pour servir des jus, des smoothies, des vinaigrettes et des sauces

	Ø cm	↑ cm	ltr.	pcs.	€/ set
82305	5,5	11,5	0,15	6	13,00



Weck-Flaschen, 6er Set

Weck-bottles, 6 pcs.
Weck-botellas, set de 6
Weck-bouteilles, set de 6



6 Flaschen + 6 Deckel, ideal zum Servieren von Säften, Smoothies, Dressings und Saucen

6 bottles + 6 covers, ideal for serving juices, smoothies, dressings and sauces

6 botellas + 6 tapas, ideal para servir zumos, batidos, aliños y salsas

6 bouteilles + 6 couvercles, idéal pour servir des jus, des smoothies, des vinaigrettes et des sauces

	Ø cm	↑ cm	ltr.	pcs.	€/ set
82307	6	14,5	0,25	6	13,50



Weck-Flaschen, 6er Set

Weck-bottles, 6 pcs.
Weck-botellas, set de 6
Weck-bouteilles, set de 6



6 Flaschen + 6 Deckel, ideal zum Servieren von Säften, Smoothies, Dressings und Saucen

6 bottles + 6 covers, ideal for serving juices, smoothies, dressings and sauces

6 botellas + 6 tapas, ideal para servir zumos, batidos, aliños y salsas

6 bouteilles + 6 couvercles, idéal pour servir des jus, des smoothies, des vinaigrettes et des sauces

	Ø cm	↑ cm	ltr.	pcs.	€/ set
82308	6	19	0,5	6	15,00



Weck-Flaschen, 6er Set

Weck-bottles, 6 pcs.
Weck-botellas, set de 6
Weck-bouteilles, set de 6



6 Flaschen + 6 Deckel, ideal zum Servieren von Säften, Smoothies, Dressings und Saucen

6 bottles + 6 covers, ideal for serving juices, smoothies, dressings and sauces

6 botellas + 6 tapas, ideal para servir zumos, batidos, aliños y salsas

6 bouteilles + 6 couvercles, idéal pour servir des jus, des smoothies, des vinaigrettes et des sauces

	Ø cm	↑ cm	ltr.	pcs.	€/ set
82309	6	25,5	1,0	6	18,00

**Weck-Gläser mit Deckel, 12er Set**

Weck-glasses with lid, 12 pcs.
Weck tarros de vidrio con tapa, set de 12
Weck verrines avec couvercle, set de 12

12 Gläser + 12 Deckel

12 glasses + 12 covers

12 vasos + 12 tapas

12 verrines + 12 couvercles



	Ø cm	↑ cm	ltr.	pcs.	€ / set
82310	6	5,5	0,08	12	22,70
82312	6	7,0	0,14	12	24,80
82314	6	8,0	0,16	12	24,80
82345	9	6,0	0,20	12	27,60

**Weck-Gläser mit Deckel, 6er Set**

Weck-glasses with lid, 6 pcs.
Weck tarros de vidrio con tapa, set de 6
Weck verrines avec couvercle, set de 6

6 Gläser + 6 Deckel

6 glasses + 6 covers

6 tarros + 6 tapas

6 verrines + 6 couvercles



	Ø cm	↑ cm	ltr.	pcs.	€ / set
82352	9	9	0,29	6	13,50

**Weck-Gläser mit Deckel, 3er Set**

Weck-glasses with lid, 3 pcs.
Weck tarros de vidrio con tapa, set de 3
Weck verrines avec couvercle, set de 3

3 Gläser + 3 Deckel

3 glasses + 3 covers

3 vasos + 3 tapas

3 verrines + 3 couvercles



	Ø cm	↑ cm	ltr.	pcs.	€ / set
82346	11	7,5	0,37	3	7,60

**Weck-Gläser mit Deckel, 2er Set**

Weck-glasses with lid, 2 pcs.
Weck tarros de vidrio con tapa, set de 2
Weck verrines avec couvercle, set de 2

2 Gläser + 2 Deckel

2 glasses + 2 covers

2 vasos + 2 tapas

2 verrines + 2 couvercles



	Ø cm	↑ cm	ltr.	pcs.	€ / set
82347	11	11	0,58	2	6,70



82350 75 ml

82316 220 ml

Weck-Gläser mit Deckel, 12er Set

Weck-glasses with lid, 12 pcs.
Weck tarros de vidrio con tapa, set de 12
Weck verrines avec couvercle, set de 12



12 Gläser + 12 Deckel
12 glasses + 12 covers
12 vasos + 12 tapas
12 verrines + 12 couvercles

	Ø cm	↑ cm	ltr.	pcs.	€/ set
82350	5,5	6	0,075	12	20,40
82316	7,0	8	0,22	12	24,80



82354 580 ml

Weck-Gläser mit Deckel, 6er Set

Weck-glasses with lid, 6 pcs.
Weck tarros de vidrio con tapa, set de 6
Weck verrines avec couvercle, set de 6



6 Gläser + 6 Deckel
6 glasses + 6 covers
6 tarros + 6 tapas
6 verrines + 6 couvercles

	Ø cm	↑ cm	ltr.	pcs.	€/ set
82354	11	9	0,58	6	15,90



82359 35 ml

82371 160 ml

Gourmetgläser, 12er Set

gourmet glasses, 12 pcs.
tarros gourmet, set de 12
verres gourmet, set de 12



	Ø cm	↑ cm	ltr.	pcs.	€/ set
82359	5	3,5	0,035	12	10,20
82370	6	5,5	0,08	12	13,80
82371	6	8,0	0,16	12	14,80



Gummidichtringe, 10er Set

rubber washer, 10 pcs.
juntas de goma, set de 10
joints de caoutchouc, set de 10



	fits to	pcs.	€/ set
82318	82307, 82308, 82309, 82310, 82312, 82314, 82316	10	1,50
82394	82345, 82352	10	1,50
82395	82346, 82347, 82354	10	1,60



8er Set Deckel-Klammer für 4 Weck-Gläser

8 pcs. cover clamps for 4 Weck-glasses
8 abrazaderas para 4 vasos Weck
8 agrafes pour 4 verrines Weck



	pcs.	€/ set
82319	8	2,50

**Edelstahldeckel für Weck-Gläser**

stainless steel lid for Weck-glasses
tapas de acero inoxidable por Weck tarros
couverts en acier inox pour Weck verrines



	Ø cm	↑ cm	fits to	€
82360	10,5	2	82346, 82347	6,00

**Holzdeckel für Weck-Gläser**

wooden lid for Weck-glasses
tapas de madera por Weck tarros
couverts en bois pour Weck verrines



	Ø cm	↑ cm	fits to	€
82362	11	2	82346, 82347	4,90

**Weck-Frischhaltedeckel, 5er Set**

airtight cover, 5 pcs.
tapa hermética, set de 5
couverts hermétique, set de 5

**für Rundrandgläser Ø 6 cm, 5er Set**

for Ø 6 cm glasses, 5 pcs. set
para vasos Ø 6 cm, set de 5
pour verrines Ø 6 cm, set de 5

	Ø cm	pcs.	€/set
82338	7	5	2,45

**Serviergestell „WECK“**

serving stand
expositor
présentoir
ohne Gläser
without glasses
sin vasos
sans verrines



	Ø cm	↑ cm		€
33246	22	59	12 x Ø 6 cm	94,00

passende Gläser / matching glasses / vasos a juego / verrines approprié



	Ø cm	↑ cm	ltr.	pcs.	€/set
82310	6	5,5	0,08	12	22,70
82312	6	7,0	0,14	12	24,80
82314	6	8,0	0,16	12	24,80
82370	6	5,5	0,08	12	13,80
82371	6	8,0	0,16	12	14,80



NEW

82330

82331

Gourmet-Gläser, 12er Set „JARLET“

gourmet glasses, 12 pcs.
vasos gourmet, set de 12
verres Gourmet, set de 12



ideal für kleine Speisen und Desserts
ideal for small dishes and desserts
ideal para tapas y postres
idéal pour les petits plats et les desserts

	Ø cm	↑ cm	ltr.	pcs.	€/set
82330	6,5	7	0,12	12	10,00
82331	6,5	8	0,15	12	11,00

SPOONS



Löffel, 6er Set „ELEVATE“

spoon, 6 pcs.
cuchara, set de 6
cuillère, set de 6



ideal geeignet zum leichten Entnehmen von Lebensmitteln aus Einmachgläsern

ideal for easy removal of food from preserving jars

ideal para sacar fácilmente los alimentos de los tarros de conserva

idéal pour retirer facilement les aliments des bocaux

	cm	→ cm	Farbe / Colour	pcs.	€ / set
75930	3 x 3,2	13,5	stainless steel	6	12,00



Gourmetlöffel „PETIT“

party spoon
cuchara gourmet
cuillère gourmet



	→ cm	Farbe / Colour		€
00677	13,5		stainless steel look	2,80
00691	12,0		gold look PVD	5,70
00692	12,0		copper look PVD	5,70
00693	12,0		gunmetal look PVD	5,70

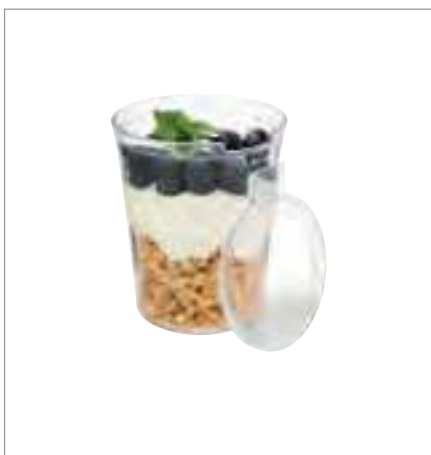

Becher mit Deckel „SUPER CUP“, 8er Set

barrel mug set, 8 pcs.
vasos, set de 8
gobelets, set de 8



Set bestehend aus 8 Bechern + 8 Deckeln

set consists of 8 barrel mugs + 8 lids

set compuesto por 8 vasos + 8 tapas

set composé de 8 gobelets + 8 couvercles

	Ø cm	↑ cm	ltr.	pcs.	€ / set
10506	8	10	0,25	8	19,00

2 tlg.
2 pcs.**Servierbrett „FUSIONA“**serving board
tabla de servir
planche de service**2-teilig: 1 Holzbrett aus Akazienholz + 1 Naturschieferplatte**2 pcs.: 1 wood board made of acacia wood + 1 natural slate tray
set de 2: 1 tabla de madera de acacia + 1 pizarra natural
set de 2: 1 planche en bois d'acacia + 1 ardoise naturelle

	cm	↑ cm	€
00814	28 x 17,5	2	16,00

mit Aussparung Ø 5 cm
with hole Ø 5 cm2 tlg.
2 pcs.**Servierbrett „FUSIONA“**serving board
tabla de servir
planche de service**2-teilig: 1 Holzbrett aus Akazienholz + 1 Naturschieferplatte**2 pcs.: 1 wood board made of acacia wood + 1 natural slate tray
set de 2: 1 tabla de madera de acacia + 1 pizarra natural
set de 2: 1 planche en bois d'acacia + 1 ardoise naturelle

	cm	↑ cm	Griff / handle cm	€
00810	26 x 18	2	8	15,00
00811	33 x 20	2	8	18,40
00812	40 x 15	2	5	23,40
00813	43 x 12	2	12	19,00

mit Hängeloch Ø 2 cm
with a handle-hole Ø 2 cm

00813



00867

00868

Servierbrett „ROCKWOOD“serving board
tabla de servir
planche de service**geeignet zur Beschriftung, mit Hängeloch Ø 1 cm**suitable for labeling, with hanging hole Ø 1 cm
apto para rotulación, con orificio para colgar Ø 1 cm
adapté pour l'étiquetage, avec trou de suspension Ø 1 cm

	cm	↑ cm	Griff / handle cm	€
00867	30,5 x 13	1,5	10	18,60
00868	36,5 x 15	1,5	12	23,60
00869	42,0 x 18	1,5	14	26,80

**Servierbrett „SHARING“**serving board
tabla de servir
planche de service**Servierbrett aus geöltem Akazienholz**serving board made of oiled acacia wood
tabla de servir de madera de acacia aceitada
planche en bois d'acacia huilé

	cm	↑ cm	Griff / handle cm	€
00887	51,5 x 18	1,5	8,5	34,00



Servierbrett „NARROW II“

serving board
tabla de servir
planche de service



Akazienholz, mit 3 Aussparungen Ø 6 cm
acacia wood, with 3 notches Ø 6 cm
madera de acacia, con 3 ranuras Ø 6 cm
bois d'acacia, avec 3 encoches Ø 6 cm

	cm	↑ cm	€
00878	31 x 11	2	12,00

**passende Schälchen / suitable bowls /
cuencos adecuados / bols appropriés**



	Ø cm	↑ cm	ltr.		VE / unit	€ / pc.
40686	8	4,5	0,17	stainless steel	24	3,60



Holzbox „TABLE“

woodbox
caja madera
base bois



Akazienholz, 3 Fächer (6,5 x 6,5 cm)
acacia wood, 3 compartments (6,5 x 6,5 cm)
madera de acacia, 3 compartimentos (6,5 x 6,5 cm)
bois d'acacia, 3 compartiments (6,5 x 6,5 cm)

	cm	↑ cm	inner size cm	€
11727	23,5 x 8,5	4,5	6,5 x 6,5 je Fach / each compartment	13,60

Servierbeispiel - Lieferung ohne Gläser
delivery without glasses



Holzbox „TABLE“

woodbox
caja madera
base bois



Akazienholz, natur
acacia wood, nature
madera de acacia, natural
bois d'acacia, naturel

	cm	↑ cm	inner size cm	€
11726	15 x 9,5	5	12 x 6,5	9,90



Serviertablett

serving tray
bandeja para servir
plateau de service



aus geöltem Eichenholz, mit 2 Griffmulden
made of oiled oak wood, with 2 recessed handles
de madera de roble aceitada, con 2 asas empotradas
en bois de chêne huilé, avec 2 poignées encastrées

	cm	↑ cm	€
00761	45 x 35	6	48,00



Präsentationsmöglichkeit
presentation example

**Servierbrett**

serving board
tabla de servir
planche de service



aus geöltem Akazienholz / made of oiled acacia wood / de madera de acacia aceitada / en bois d'acacia huilé

	cm	↑ cm	€
00793	25 x 17	1,5	13,00

**Servierbrett „VELVET“**

serving board
tabla de servir
planche de service



aus geöltem Akazienholz / made of oiled acacia wood / de madera de acacia aceitada / en bois d'acacia huilé

	cm	↑ cm	€
00897	30 x 15	2	14,20
00898	30 x 18	2	16,50
00899	35 x 25	2	23,00

**Servierbrett**

serving board
tabla de servir
planche de service



aus geöltem Akazienholz / made of oiled acacia wood / de madera de acacia aceitada / en bois d'acacia huilé

	cm	↑ cm	€
00792	37 x 8	2	10,80

**Servierbrett „NARROW I“**

serving board
tabla de servir
planche de service



Akazienholz, mit 3 Vertiefungen Ø 4 cm / acacia wood, with 3 notches Ø 4 cm
madera de acacia, con 3 ranuras Ø 4 cm / bois d'acacia, avec 3 encoches Ø 4 cm

	cm	↑ cm	€
00864	22 x 8	1,5	10,60

passende Schälchen / fitting bowls / cuencos adecuados / bols appropriés

	Ø cm	↑ cm	ltr.	VE / unit	€/ pc.	
40685	6	3,0	0,05	stainless steel	24	2,40

**Servierbrett „PIZZA“**

serving board
tabla de servir
planche de service



Eichenholz geölt, mit Safrinne, mit 2 Griffmulden

oak wood oiled, with juice groove, with 2 recessed handles
madera de roble aceitada, con ranura para líquidos, con 2 asas empotradas
bois de chêne huilé, avec rigole, avec 2 poignées encastrées

	Ø cm	↑ cm	€
00757	34	2	32,00



Servierbrett „OLIVE“

servicing board
 tabla de servir en madera de olivo
 planche de service en bois d'olivier



aus geöltem Olivenholz, naturbedingte Abweichung in Form, Maserung und Größe, mit Hängeloch Ø 2 cm

oiled olive wood, natural deviation in shape, grain and size, with hanging hole Ø 2 cm
 de madera de olivo aceitada, diferencias naturales posibles en forma, grano y tamaño, con orificio para colgar Ø 2 cm

en bois d'olivier huilé, éventuelles différences naturelles de forme, de grain et de taille, avec trou de suspension Ø 2 cm

	cm	↑ cm	Griff / handle cm	€
00870	25 x 17,0	1,5		32,00
00871	30 x 20,5	2,0		52,00
00873	40 x 15,0	1,5	11	56,00
00874	44 x 20,0	2,0	12	72,00
00876	25 x 16,0	1,5	8	35,00
00877	31 x 20,0	1,5	9	52,00

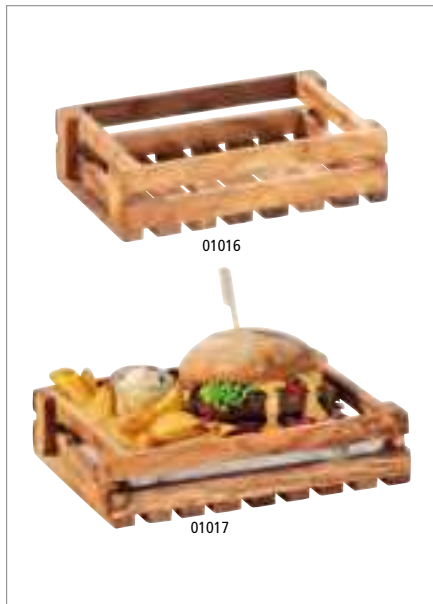

Table Caddy „OLIVE“

table barrel
 caddy de mesa
 caddy de table



aus geöltem Olivenholz

oiled olive wood
 de madera de olivo aceitada
 en bois d'olivier huilé

	cm	↑ cm	€
01016	22 x 15	6	21,00
01017	25 x 18	6	29,00





Schale „OLIVE“

bowl
cuenco
bol



aus geöltem Olivenholz
oiled olive wood
de madera de olivo aceitada
en bois d'olivier huilé

	cm	↑ cm	ltr.	€
00907	13,0 x 8,0	6,5	0,2	6,60
00908	16,0 x 9,0	7,0	0,3	10,00
01023	25,0 x 8,5	7,5	0,4	18,00



Schale „OLIVE“

bowl
cuenco
bol



aus geöltem Olivenholz, naturbedingte Abweichung in Form, Maserung und Größe
oiled olive wood, natural deviation in shape, grain and size
de madera de olivo aceitada, diferencias naturales posibles en forma, grano y tamaño
en bois d'olivier huilé, éventuelles différences naturelles de forme, de grain et de taille

	cm	↑ cm	ltr.	€
01013	7,5 x 7,5	2,5	0,05	5,00
01014	17,5 x 8,5	2,5	0,15	12,40
01015	26,5 x 11,5	5,0	0,60	19,00



Servierbrett „OLIVE“

servicing board
tabla de servir
planche de service



aus geöltem Olivenholz, naturbedingte Abweichung in Form, Maserung und Größe
oiled olive wood, natural deviation in shape, grain and size
de madera de olivo aceitada, diferencias naturales posibles en forma, grano y tamaño
en bois d'olivier huilé, éventuelles différences naturelles de forme, de grain et de taille

	cm	↑ cm	€
01022	39,5 x 21,0	2,5	32,00
01021	35,5 x 18,5	2,0	24,00

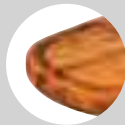

mit Safrille
with juice groove



Servierbrett „OLIVE“

servicing board
tabla de servir
planche de service



aus geöltem Olivenholz, naturbedingte Abweichung in Form, Maserung und Größe
oiled olive wood, natural deviation in shape, grain and size
de madera de olivo aceitada, diferencias naturales posibles en forma, grano y tamaño
en bois d'olivier huilé, éventuelles différences naturelles de forme, de grain et de taille

	cm	↑ cm	€
00905	25,5 x 16,5	1,5	12,00
00906	35,0 x 20,5	1,5	22,00



Schale, 4er Set „OLIVE“

bowl, 4 pcs.
cuenco, set de 4
bol, set de 4



aus geöltem Olivenholz, naturbedingte Abweichung in Form, Maserung und Größe

oiled olive wood, natural deviation in shape, grain and size

de madera de olivo aceitada, diferencias naturales posibles en forma, grano y tamaño
en bois d'olivier huilé, éventuelles différences naturelles de forme, de grain et de taille

	Ø cm	↑ cm	ltr.	pcs.	€/ set
01024	6	2	0,03	4	14,00



01010 0,15 ltr.



01011 0,25 ltr.



01012 0,50 ltr.

Schale „OLIVE“

bowl
cuenco
bol



aus geöltem Olivenholz, naturbedingte Abweichung in Form, Maserung und Größe

oiled olive wood, natural deviation in shape, grain and size

de madera de olivo aceitada, diferencias naturales posibles en forma, grano y tamaño
en bois d'olivier huilé, éventuelles différences naturelles de forme, de grain et de taille

	Ø cm	↑ cm	ltr.	€
01010	10,0	4,0	0,15	10,00
01011	12,5	4,5	0,25	13,80
01012	15,0	6,0	0,50	20,00



3 Größen ineinander
3 sizes in each other



00843 0,05 ltr.



00844 0,10 ltr.

Schale „OLIVE“

bowl
cuenco
bol



aus geöltem Olivenholz, naturbedingte Abweichung in Form, Maserung und Größe

oiled olive wood, natural deviation in shape, grain and size

de madera de olivo aceitada, diferencias naturales posibles en forma, grano y tamaño
en bois d'olivier huilé, éventuelles différences naturelles de forme, de grain et de taille

	cm	↑ cm	ltr.	€
00843	12,0 x 7,5	2,5	0,05	7,80
00844	16,5 x 9,5	2,5	0,10	10,00

SIMPLY WOOD

**Servierbrett „SIMPLY WOOD“**

serving board
tabla de servir
planche de service



Eichenholz geölt, mit Aufhängeloch Ø 1,5 cm, mit Lederband

oak wood oiled, with handle hole Ø 1,5 cm, with leather strap
madera de roble aceitada, con agujero para colgar Ø 1,5 cm, con correa de cuero
bois de chêne huilé, avec trou de suspension Ø 1,5 cm, avec ruban en cuir

	cm	↑ cm	→ Griff / handle	€
00751	27 x 17	2	8	32,00
00752	32 x 22	2	8	42,00

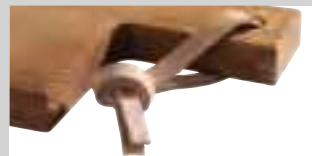

mit Lederband
with leather strap

**Tablett / Sushiboard „SIMPLY WOOD“**

tray / sushiboard
bandeja para sushi
plateau sushi



aus geöltem Eichenholz
made of oiled oak wood
de madera de roble aceitada
en bois de chêne huilé

	cm	↑ cm	€
00753	35 x 17	2	23,80

**GN 1/3 Servierbrett „SIMPLY WOOD“**

GN 1/3 serving board
GN 1/3 tabla de servir
GN 1/3 planche de service



Eichenholz geölt, mit Aussparung Ø 4 cm, mit Safrinne

oak wood oiled, with notch Ø 4 cm, with juice groove
madera de roble aceitada, con ranura Ø 4 cm, con ranura para líquidos
bois de chêne huilé, avec encoche Ø 4 cm, avec rigole

	cm	↑ cm	GN	€
00754	32,5 x 17,6	2	1/3	23,80

TRAYS



Tablett „TREND“

baking sheet
bandeja
plateau



ein Backblech wird zum Serviertablett

a baking sheet which becomes a serving tray

una bandeja de hornear que se convierte en una bandeja de servir

un moule qui devient un plateau de service

	cm	↑ cm	Farbe / Colour	€
13380	32 x 21,5	2	aluminium	10,60
13381 <small>NEW</small>	37 x 26,5	2	aluminium	12,00



Tablett

tray
bandeja
plateau



	cm	↑ cm	GN	€
00845	32,5 x 26,5	3	1/2	13,00



Tablett „VINTAGE“

tray
bandeja
plateau



Vintage-Look

	cm	↑ cm	€
30130	26,0 x 13,5	1,5	8,00
30131	34,0 x 18,0	1,5	13,20
30134	32,0 x 21,5	2,0	16,40
30132	38,0 x 26,5	1,5	21,00
30133	25,5 x 16,0	3,0	16,00

passende Schälchen / fitting bowls / cuencos adecuados / bols apropiés



	Ø cm	↑ cm	ltr.	€
40655	7,5	5,5	0,17	3,20
40656	7,5	10,0	0,35	4,00



Wachspapier „SNACKHOLDER“

greaseproof paper squares
papel alimenticio
papier alimentaire

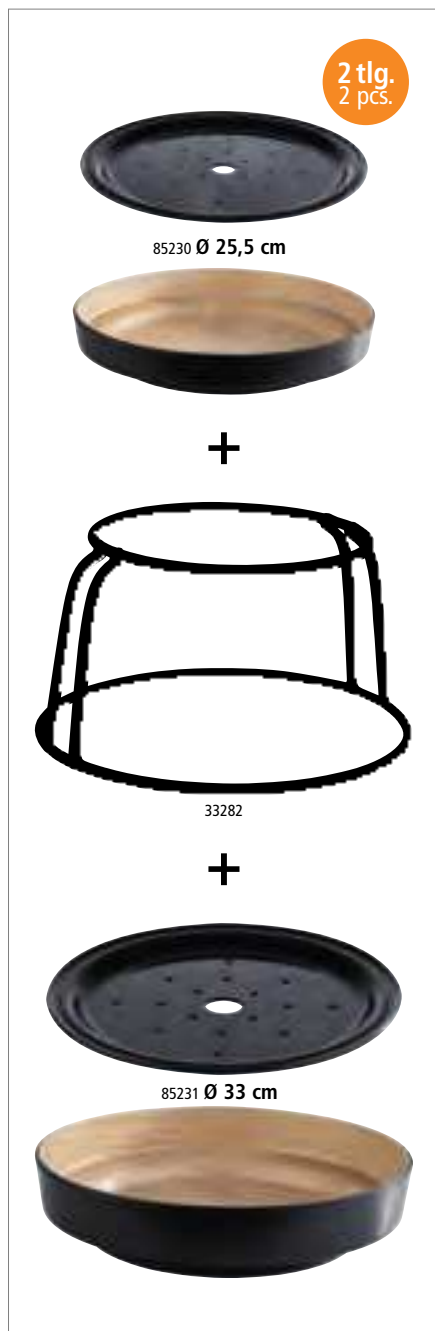

	cm	pcs.	€
40670	42 x 25	500	59,00

**Schale, 2-teilig „FRIDA“**

bowl, 2 pcs.
cuenco, set de 2
bol, set de 2



inklusive Abtropfeinsatz
including drip tray
con bandeja recogegotas
avec égouttoir

	Ø cm	↑ cm		€
85230	25,5	6		29,00
85231	33,0	6		49,00

Buffetständer

buffet stand
soporte para buffet
présentoir buffet



Metall, mit schwarzer Antirutschbeschichtung, für Schalen Nr. 85230, 85231
metal, with black anti-slide coating, for bowls no. 85230, 85231
metal, con revestimiento antideslizante negro, para cuencos 85230, 85231
métal, avec revêtement antidérapant noir, pour bols 85230, 85231

	Ø cm	↑ cm		€
33282	23 / 30,5	16		40,00

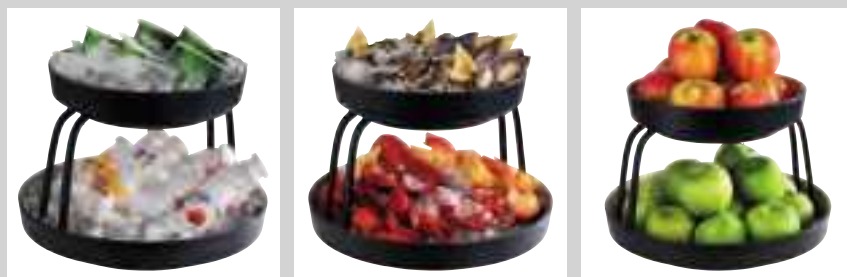

Präsentationsmöglichkeit
presentation example



mit Abtropfeinsatz
with drip tray



Topf darf nicht erhitzt werden!
Topf ist nicht zum Kochen geeignet!

Servier-Muscheltopf

serving mussel pot
mejillonera para servir
casserole à moules pour servir

schwarz emailliertes Stahlblech, mit Edelstahlrand
black enamelled steel, stainless steel rim
hierro esmaltado negro, borde inox
acier émaillé noir, bord inox



	Ø cm	↑ cm	Topf / pot ltr.	Deckel / lid ltr.	€
00623	13,5	9,0	0,75	0,60	10,80
00625	18,0	12,0	2,60	1,40	15,00
00626	20,0	13,0	3,30	1,60	17,00
00627	24,0	13,5	5,20	2,70	20,00

TRAYS



Kaviarkühler caviar cooler enfriador de caviar rafraîchisseur de caviar



4-teilig: Glasschale Ø 10 cm / 4 pcs.: glass bowl Ø 10 cm
set de 4: bol Ø 10 cm

	Ø cm	↑ cm	€
01699	18	12	56,00



Serviertablett „KAFFEEHAUS“

tray
bandeja
plateau



matt poliert, oval, Rand ingerollt
matt polished, oval, rolled edge
pulido mate, oval, borde redondeado
poli mat, ovale, bord rond

für Zucker und Sahne / for sugar and cream / para azúcar y crema / pour le sucre et la crème

	cm	↑ cm	€
30111	20,0 x 14,5	0,5	4,70

für eine Tasse / for one cup / para una taza / pour une tasse

	cm	↑ cm	€
30112	26,5 x 19,5	0,5	7,00

für zwei Tassen / for two cups / para dos tazas / pour deux tasses

	cm	↑ cm	€
30113	29,0 x 22,0	0,5	7,50



Serviertablett „KAFFEEHAUS“

tray
bandeja
plateau



hochglanzpoliert, oval, Rand ingerollt
mirror polished, oval, rolled edge
pulido brillante, ovalado, borde redondeado
poli brillant, ovale, bord rond

für Zucker und Sahne / for sugar and cream / para azúcar y crema / pour le sucre et la crème

	cm	↑ cm	€
30115	20,0 x 14,5	0,5	4,70

für eine Tasse / for one cup / para una taza / pour une tasse

	cm	↑ cm	€
30116	26,5 x 19,5	0,5	7,00

für zwei Tassen / for two cups / para dos tazas / pour deux tasses

	cm	↑ cm	€
30117	29,0 x 22,0	0,5	7,50



NEW

Serviertablett „VALO“

tray
bandeja
plateau



Eichenholz (geölt), Innenmaß 56 x 36 cm

oak wood (oiled), inside dimensions 56 x 36 cm

madera de roble (aceitada), dimensiones interiores 56 x 36 cm

bois du chêne (huilé), dimensions intérieures 56 x 36 cm

	cm	↑ cm	fits to	€
14060	60 x 40	3	14061	82,00



NEW

Tablettständer „VALO“

tray stand
soporte para bandejas
support de plateau



Eichenholz (geölt), zusammenklappbar

oak wood (oiled), collapsible

madera de roble (aceitada), plegable

bois du chêne (huilé), pliable

	cm	↑ cm	fits to	€
14061	56 x 35,5	75	14060	130,00



mit Magnetbefestigung
with magnetic attachment





MENAGES



Menage „WOOD“

menage
menage
ménage



matt poliert, Glasbehälter mit Edelstahldeckel und Deckelverschluss

matt polished, glass with stainless steel cover
pulido mate, cristal con tapa de acero inoxidable
verre et inox poli mat, avec couvercle inox

	cm	↑ cm	€
40435	11,5 x 5,5	17	17,70



Menage „WOOD“

menage
menage
ménage



matt poliert, Glasbehälter mit Edelstahldeckel und Deckelverschluss

matt polished, glass with stainless steel cover
pulido mate, cristal con tapa de acero inoxidable
verre et inox poli mat, avec couvercle inox

	cm	↑ cm	€
40436	16 x 7,5	24,5	26,50



Menage „WOOD“

menage
menage
ménage



matt poliert, möbelschonende Unterseite

matt polished, glass with stainless steel cover
pulido mate, con tapa de acero inoxidable
verre et inox poli mat, avec couvercle inox

	cm	↑ cm	€
40437	15,5 x 12	24,5	35,30

Salz- und Pfefferstreuer / salt - and pepper shaker / juego de sal y pimienta / set sel et poivre

	Ø cm	↑ cm	€
40438	4	9	6 Löcher - Ø 1,85 mm 4,40
40439	4	9	18 Löcher - Ø 1,35 mm 4,40

Ersatzglas Essig / Öl / spare glass vinegar / oil / cristal de recambio con tapa „aceite & vinagre“
verre huile ou vinagre

	Ø cm	↑ cm	ltr.	€
40442	6	18,5	0,2	7,00



Menage „ELEMENT“

menage
menage
ménage



Betonständer, Glasbehälter mit Edelstahldeckel, möbelschonende Unterseite

stand made of concrete, glass with stainless steel cover, furniture-friendly underside
soporte de hormigón, recipiente de vidrio con tapa de acero inoxidable, con base anti rayaduras

support en béton, récipient en verre avec couvercle en acier inox, revêtement antirayures

	cm	↑ cm	€
40410	10 x 6	17	17,70



Menage „ELEMENT“

menage
menage
ménage



Betonständer, Glasbehälter mit Edelstahldeckel und tropffreiem Kunststoff-Ausgießer, möbelschonende Unterseite

stand made of concrete, glass with stainless steel cover and non-drip nozzle-spout, furniture-friendly underside

soporte de hormigón, recipiente de vidrio con tapa de acero inoxidable y sistema antigoteo, base anti rayaduras

support en béton, récipient en verre avec couvercle en acier inox et verseur antigoutte, revêtement antirayures

	cm	↑ cm	€
40411	14 x 8	25	26,50



Menage „ELEMENT“

menage
menage
ménage



Betonständer, Glasbehälter mit Edelstahldeckel und Drehverschluss, möbelschonende Unterseite

stand made of concrete, glass with stainless steel cover and screw cap, furniture-friendly underside

soporte de hormigón, recipiente de vidrio con tapa de acero inoxidable y tapón de rosca, base anti rayaduras

support en béton, récipient en verre avec couvercle en acier inox et bouchon à vis, avec revêtement antirayures

	cm	↑ cm	€
40412	12,5 x 12,5	25	37,60

MENAGES



Menage „CLASSIC“

menage
menage
ménage



Glasbehälter mit Edelstahldeckel und Drehverschluss

glass with stainless steel cover
vidrio con tapa de acero inoxidable con rosca
en verre avec couvercle inox à visser

	cm	↑ cm		€
40310	10,5 x 6,5	16		18,90



Menage „CLASSIC“

menage
menage
ménage



Glasbehälter mit Edelstahldeckel und Drehverschluss

glass with stainless steel cover
vidrio con tapa de acero inoxidable con rosca
en verre avec couvercle inox à visser

	Ø cm	↑ cm		€
40320	10,5	16		24,40



Menage „CLASSIC“

menage
menage
ménage



Glasbehälter mit Edelstahldeckel und tropffreiem Kunststoff-Ausgießer

with stainless steel cover and non-drip nozzle-spout
vidrio con tapa inox y sistema antigoteo
verre avec couvercle inox et verseur antigoutte

	cm	↑ cm	ltr.	€
40440	14,5 x 8,5	23	0,2	30,00
40450	17,5 x 10,5	23		36,00

Ersatzglas mit Deckel / spare glass with cover / vidrio con tapa / verre + couvercle

	Ø cm	↑ cm		€
40312	4	9	18 Löcher - Ø 1,35 mm	4,20
40311	4	9	6 Löcher - Ø 1,85 mm	4,20

Ersatzglas mit Deckel „Essig & Öl“ / spare glass with cover „vinegar & oil“ / cristal de recambio con tapa „vinegar & oil“ / verre huile ou vinaige avec couvercle inox et verseur antigoutte

	Ø cm	↑ cm	ltr.	€
40441	6	18,5	0,2	8,00

Ersatzglas mit Deckel „Zahnstocher“ / spare glass with cover „toothpick“ / porta-palillos vidrio con tapa / verre à cure-dents + couvercle

	Ø cm	↑ cm		€
40313	4	9		4,20



Senftöpfchen, 2er Set

mustard glass, 2 pcs. set
piezas vasos mostaza, set de 2
verres à moutarde, set de 2



inklusive Löffel und Edelstahldeckel

including spoons and covers
incluye cucharas y tapas
cuillères et couvercles inclus

	Ø cm	↑ cm	ltr.	pcs.	€
40415	5	6	0,07	2	5,90



40476



40478



40480

Menage „PRO“

menage
menage
ménage



matt poliert, Glasbehälter mit Edelstahldeckel und tropffreiem Kunststoff-Ausgießer

matt polished, glass with stainless steel cover and non-drip nozzle-spout

pulido mate, vidrio, sistema antigoteo

poli mat et verre, insert plastique antigoutte

	cm	↑ cm	€
40476	12,0 x 8,0	19	11,90
40478	12,5 x 11,0	19	16,70
40480	13,0 x 11,0	19	17,70

Pfeffer- oder Salz-Glasstreuer / pepper- or salt-glass with cover / salero o pimentero de cristal con tapa / salière ou poivrière seule en verre avec couvercle inox

	Ø cm	↑ cm	€
40461	3	9	2,20

Essig- oder Öl-Glasbehälter / oil- or vinegar-glass with cover / aceitera-vinagrera con tapa bouteille huile ou vinaigre seule en verre et couv. inox

	Ø cm	↑ cm	€
40462	4,5	16	3,60



40470



40472



40474

Menage „PRO“

menage
menage
ménage



matt poliert, Glasbehälter mit Edelstahldeckel und Drehverschluss

matt polished, glass with stainless steel cover

pulido mate, vidrio y tapas con rosca

poli mat et verre, couvercle à visser

	cm	↑ cm	€
40470	8,5 x 5,5	11,5	6,10
40472	9,0 x 8,5	11,5	7,70
40474	10,0 x 10,0	11,5	8,70



Menage „ECONOMIC“

menage
menage
ménage



Glasbehälter mit Edelstahldeckel und Drehverschluss

glass with stainless steel cover
cristal con tapa inox a rosca
en verre avec couvercle inox à visser

	cm	↑ cm	€
40455	8 x 4	13	4,70



Menage „ECONOMIC“

menage
menage
ménage



Glasbehälter mit Edelstahldeckel und Drehverschluss

glass with stainless steel cover
cristal con tapa inox a rosca
en verre avec couvercle inox à visser

	cm	↑ cm	€
40457	8 x 8	12	7,40

Glas für Senf / glass for mustard / vaso de cristal para mostaza / pot verre seul pour la moutarde

	cm	€
40464		2,00



40458

Menage „ECONOMIC“

menage
menage
ménage



Glasbehälter mit Edelstahldeckel und tropffreiem Kunststoff-Ausgießer

glasses with stainless steel cover and non-drip nozzle-spout
cristales con tapa de acero inoxidable y sistema antigoteo
en verre avec couvercle inox et insert plastique antigoutte

	cm	↑ cm	€
40458	11,5 x 5,5	22	9,60
40460	11,0 x 10,5	22	13,20

Pfeffer- oder Salz-Glasstreuer / pepper- or salt-glass with cover salero o pimentero de cristal con tapa / salière ou poivrière seule en verre avec couvercle inox

	Ø cm	↑ cm	€
40461	3	9	2,20

Essig- oder Öl-Glasbehälter / oil- or vinegar-glass with cover / aceitera-vinagrera con tapa bouteille huile ou vinaigre seule en verre et couv. inox

	Ø cm	↑ cm	€
40462	4,5	16	3,60

Glas für Zahnstocher / glass for tooth picks / vaso de cristal para palillos de dientes porte-cure-dents env erre

	Ø cm	↑ cm	€
40463	3	6	1,50



40460



Menage
menage
menage
ménage



drehbares Gestell, Glasbehälter mit Edelstahldeckel und Drehverschluss

rotating stand, glass with stainless steel cover
soporte giratorio con piezas de vidrio y tapas inox
tournant, avec pièces en verre et couvercle inox

	Ø cm	↑ cm	€
40485	16	20	20,40



Essig- & Öl-Menage
oil- and vinegar-menage
aceitera-vinagrera
ménage huile et vinaigre



Glasbehälter mit Deckel und tropffreiem PE-Ausgießer

glass with lid and non-drip nozzle-spout
recipiente de cristal con tapa y sistema antigoteo
pot en verre avec couvercle et système plastique antigoutte

	cm	↑ cm	litr.	€
40445	10,5 x 5,5	24	0,12	10,10
40446	13,0 x 7,0	34	0,50	13,70



tropffreier Ausgießer
non-drip spout



Essig- & Öl-Flasche
oil- and vinegar bottle
botella de aceite y vinagre
bouteille d'huile et vinaigre



Behälter aus Glas, Ausgießer aus Kork und Edelstahl

container made of glass, cork pouring made of spout and stainless steel
recipiente de vidrio, pico de corcho y acero inox
bouteille d'huile et vinaigre

	Ø cm	↑ cm	litr.	€
40512	5	15,5	0,1	5,60



Essig- & Öl-Flasche „OLD FASHIONED“
oil- and vinegar bottle
botella de aceite y vinagre
bouteille d'huile et vinaigre



Glasflasche, Edelstahl - Ausgießer mit Deckel

glass bottle, stainless steel spout with lid
botella de vidrio, pico verteder de acero inoxidable con tapa
bouteille en verre, bec verseur en acier inox avec couvercle

	Ø cm	↑ cm	litr.	€
40511	7	22	0,35	6,40

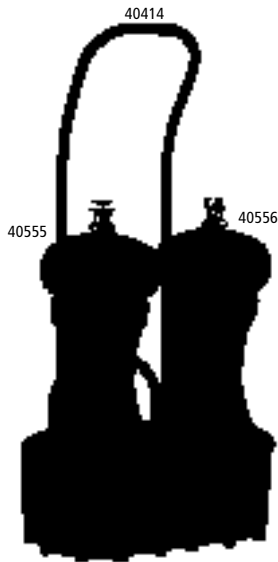

Ständer „URBAN“

serving stand
soporte 2 botellas
support 2 bouteilles



Metall schwarz, mit Kartenhalterung

metal black, with card holder
metal negro, con tarjetero
métal noir, avec porte-cartes

	cm	↑ cm	€
40414	13 x 8,5	25	8,00

Pfeffermühle / pepper mill / molinillo de pimienta / moulin à poivre

	Ø cm	↑ cm	€
40555	6	15,5	33,20

Salzmühle / salt mill / molinillo de sal / moulin à sel

	Ø cm	↑ cm	€
40556	6	15,5	33,20

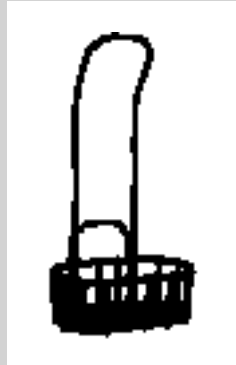

mit Kartenhalterung an der Rückseite
with card holder at the back



Spritzflasche

dash bottle
botella
bouteille



Ausgießer aus Kork, Edelstahl

cork pouring spout, stainless steel
pico de corcho, acero inox
bec verseur liège, acier inox

	cm	↑ cm	litr.	€
93359	5 x 5	13	0,1	6,80



Parmesan-Menage „CLASSIC“

cheese dish
quesera parmesano
service à parmesan

schwarz matt, inklusive Löffel

black mat, with spoon
negro mate, con cuchara
noir mat, avec cuillère



	Ø cm	↑ cm	ltr.	€
40333	11	7	0,18	24,00

Ersatzbehälter / sparecontainer / bol de recambio / bol de rechange

	Ø cm	↑ cm	ltr.	€
40331	9	5	0,18	6,40



Parmesan-Menage „CLASSIC“

cheese dish
quesera parmesano
service à parmesan

hochglanzpoliert, inklusive Löffel

mirror polished, with spoon
pulido brillante, con cuchara
poli brillant, avec cuillère



	Ø cm	↑ cm	ltr.	€
40330	11	7	0,18	21,00

Ersatzbehälter / sparecontainer / bol de recambio / bol de rechange

	Ø cm	↑ cm	ltr.	€
40331	9	5	0,18	6,40



Parmesan-Menage „PRO“

cheese dish
quesera parmesano
service à parmesan

matt poliert, inklusive Löffel

matt polished, with spoon
pulido mate, con bol cristal y cuchara
poli mat, avec bol verre et cuillère



	Ø cm	↑ cm	ltr.	€
40482	10,5	13	0,18	11,00

Ersatzbehälter / sparecontainer / bol de recambio / bol de rechange

	Ø cm	↑ cm	ltr.	€
40331	9,0	5	0,18	6,40



Parmesan-Menage „ECONOMIC“

cheese dish
quesera parmesano
service à parmesan

inklusive Kunststofflöffel

with spoon
con cuchara
avec cuillère



	Ø cm	↑ cm	ltr.	€
40453	10	7,5	0,23	7,00

Ersatzbehälter / sparecontainer / bol de recambio / bol de rechange

	Ø cm	↑ cm	ltr.	€
40454	9	5,5	0,23	2,30

MILLS



Pfeffermühle „ETERNAL“

pepper mill
molinillo de pimienta
moulin à poivre



aus Buchenholz, Keramikmahlwerk, Mahlgrad stufenlos einstellbar

made of beech wood, ceramic grinder, infinitely adjustable grinding degree

madera de haya, molinillo de cerámica, el grado de molino se puede ajustar de modo continuo

bois de hêtre, moulin en céramique, la finesse de mouture se peut réglée de façon continue

	Ø cm	↑ cm	Farbe / Colour	€
40570	5,5	15,5		19,00
40571	5,5	15,5		19,00
40572	6,0	23,0		22,00
40573	6,0	23,0		22,00



Keramikmahlwerk
ceramic grinder



einfach zu Öffnen
easy opening

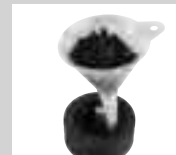

einfach zu Befüllen
easy to refill



Salzmühle „ETERNAL“

salt mill
molinillo de sal
moulin à sel



aus Buchenholz, Keramikmahlwerk, Mahlgrad stufenlos einstellbar

made of beech wood, ceramic grinder, infinitely adjustable grinding degree

madera de haya, molinillo de cerámica, el grado de molino se puede ajustar de modo continuo

bois de hêtre, moulin en céramique, la finesse de mouture se peut réglée de façon continue

	Ø cm	↑ cm	Farbe / Colour	€
40574	5,5	15,5		19,00
40575	5,5	15,5		19,00
40576	6,0	23,0		22,00
40577	6,0	23,0		22,00



Keramikmahlwerk
ceramic grinder



einfach zu Öffnen
easy opening





P



40535

40546

Pfeffermühle „COUNTRY“pepper mill
molinillo de pimienta
moulin à poivre**Deutsches Buchenholz, Mahlwerk aus Carbonstahl, Mahlgrad stufenlos einstellbar**

german beechwood, mill in carbon steel, the grinding degree can be adjusted infinitely

madera de haya alemana, molinillo de acero al carbono, el grado de molino se puede ajustar de modo continuo

bois de hêtre d'Allemagne, moulin en acier de carbone, la finesse de mouture se peut réglée de façon continue

	Ø cm	↑ cm	Farbe / Colour	€
40535	5,5	15		24,70
40546	5,5	15		24,70

S



40536

40547

Salzmühle „COUNTRY“salt mill
molinillo de sal
moulin à sel**deutsches Buchenholz, Mahlwerk aus Edelstahl, Mahlgrad stufenlos einstellbar**

german beechwood, mill in stainless steel, the grinding degree can be adjusted infinitely

madera de haya alemana, molinillo de acero inoxidable, el grado de molino se puede ajustar de modo continuo

bois de hêtre d'Allemagne, moulin en acier inox, la finesse de mouture se peut réglée de façon continue

	Ø cm	↑ cm	Farbe / Colour	€
40536	5,5	15		24,70
40547	5,5	15		24,70

P

**Pfeffermühle „GUNMETAL“**pepper mill
molinillo de pimienta
moulin à poivre**Mahlwerk aus Carbonstahl, Mahlgrad stufenlos einstellbar**

mill in carbon steel, the grinding degree can be adjusted infinitely

molinillo de acero al carbono, el grado de molino se puede ajustar de modo continuo

moulin en acier de carbone, la finesse de mouture se peut réglée de façon continue

	Ø cm	↑ cm	€
40555	6	15,5	33,20

S

**Salzmühle „GUNMETAL“**salt mill
molinillo de sal
moulin à sel**Mahlwerk aus Edelstahl, Mahlgrad stufenlos einstellbar**

mill in stainless steel, the grinding degree can be adjusted infinitely

molinillo de acero inoxidable, el grado de molino se puede ajustar de modo continuo

moulin en acier inox, la finesse de mouture se peut réglée de façon continue

	Ø cm	↑ cm	€
40556	6	15,5	33,20

SALT- / PEPPER MILLS



Pfeffermühle „MIDNIGHT“

pepper mill
molinillo de pimienta
moulin à poivre



Akazienholz, Mahlwerk aus Carbonstahl, Mahlgrad stufenlos einstellbar

acacia wood, mill in carbon steel, grinding degree infinitely adjustable
madera de acacia, molinillo de acero al carbono, Molienda ajustable de forma continua
bois d'acacia, moulin en acier de carbone, réglée de façon continue tige en acier inox

	Ø cm	↑ cm	Farbe / Colour	€
40578	5	17	■	16,00



Salzmühle „MIDNIGHT“

salt mill
molinillo de sal
moulin à sel



Akazienholz, Mahlwerk aus Edelstahl, Mahlgrad stufenlos einstellbar

acacia wood, mill in stainless steel, grinding degree infinitely adjustable
madera de acacia, molinillo de acero inoxidable, Molienda ajustable de forma continua
bois d'acacia, moulin en acier inox, réglée de façon continue tige en acier inox

	Ø cm	↑ cm	Farbe / Colour	€
40579	5	17	■	16,00



Pfeffer- und Salz-Menage „URBAN“

salt- and pepper-menage
salero-pimentero
ménage sel et poivre



3-teiliges Set, bestehend aus:

- Gestell, Metall, schwarz, mit Kartenhalterung
- Pfeffermühle aus Akazienholz mit Mahlwerk aus Carbonstahl
- Salzmühle aus Akazienholz mit Mahlwerk aus Edelstahl

3 pcs., consisting of:

- stand, metal, black, with card holder
- pepper mill made of acacia wood with grinding mechanism made of carbon steel
- salt mill made of acacia wood with grinding mechanism made of stainless steel

set de 3, compuesto por:

- soporte, metal, negro, con porta menu
- molinillo de pimienta de madera de acacia con mecanismo de molienda de acero al carbono
- molinillo de sal de madera de acacia con mecanismo de molienda de acero inoxidable

set de 3, composé de :

- support, métal, noir, avec porte-cartes
- moulin à poivre en bois d'acacia avec broyeur en acier au carbone
- moulin à sel en bois d'acacia avec broyeur en acier inox

	cm	↑ cm	€
40416	12 x 8,5	24	38,00

Pfeffermühle / pepper mill / molinillo de pimienta / moulin à poivre

	Ø cm	↑ cm	€
40417	5	17	16,00

Salzmühle / salt mill / molinillo de sal / moulin à sel

	Ø cm	↑ cm	€
40418	5	17	16,00

P

**Pfeffermühle „ELEMENT“**

pepper mill
molinillo de pimienta
moulin à poivre



Mahlwerk aus Carbonstahl, Mahlgrad stufenlos einstellbar

mill in carbon steel, the grinding degree can be adjusted infinitely

molinillo de acero al carbono, el grado de molino se puede ajustar de modo continuo

moulin en acier de carbone, la finesse de mouture se peut régler de façon continue

	Ø cm	↑ cm	€
40538	6	18	27,00

S

**Salzmühle „ELEMENT“**

salt mill
molinillo de sal
moulin à sel



Mahlwerk aus Edelstahl, Mahlgrad stufenlos einstellbar

mill in stainless steel, the grinding degree can be adjusted infinitely

molinillo de acero inoxidable, el grado de molino se puede ajustar de modo continuo

moulin en acier inox, la finesse de mouture se peut régler de façon continue

	Ø cm	↑ cm	€
40539	6	18	27,00

P

**Pfeffermühle „ELEMENT“**

pepper mill
molinillo de pimienta
moulin à poivre



Mahlwerk aus Carbonstahl, Mahlgrad stufenlos einstellbar

mill in carbon steel, the grinding degree can be adjusted infinitely

molinillo de acero al carbono, el grado de molino se puede ajustar de modo continuo

moulin en acier de carbone, la finesse de mouture se peut régler de façon continue

	Ø cm	↑ cm	€
40557	7,5	15,5	23,60

S

**Salzmühle „ELEMENT“**

salt mill
molinillo de sal
moulin à sel



Mahlwerk aus Edelstahl, Mahlgrad stufenlos einstellbar

mill in stainless steel, the grinding degree can be adjusted infinitely

molinillo de acero inoxidable, el grado de molino se puede ajustar de modo continuo

moulin en acier inox, la finesse de mouture se peut régler de façon continue

	Ø cm	↑ cm	€
40558	7,5	15,5	23,60



Pfeffermühle „CLARITY“

pepper mill
molinillo de pimienta
moulin à poivre



Edelstahl, mattiert, Mahlwerk aus Carbonstahl, Mahlgrad stufenlos einstellbar

stainless steel, matt, mill in carbon steel, grinding degree infinitely adjustable
acero inoxidable, mate, molinillo de acero al carbono, Molienda ajustable de forma continua
acier inox, mat, moulin en acier de carbone, réglée de façon continue tige en acier inox

	Ø cm	↑ cm	Farbe / Colour	€
40580	6	13		17,20



Salzmühle „CLARITY“

salt mill
molinillo de sal
moulin à sel



Edelstahl, mattiert, Mahlwerk aus Edelstahl, Mahlgrad stufenlos einstellbar

stainless steel, matt, mill in stainless steel, grinding degree infinitely adjustable
acero inoxidable, mate, molinillo de acero inoxidable, Molienda ajustable de forma continua
acier inox, mat, moulin en acier inox, réglée de façon continue tige en acier inox

	Ø cm	↑ cm	Farbe / Colour	€
40581	6	13		17,20



Pfeffermühle „CLARITY“

pepper mill
molinillo de pimienta
moulin à poivre



Mahlwerk aus Carbonstahl, Mahlgrad stufenlos einstellbar

mill in carbon steel, grinding degree infinitely adjustable
molinillo de acero al carbono, Molienda ajustable de forma continua
moulin en acier de carbone, réglée de façon continue tige en acier inox

	Ø cm	↑ cm	Farbe / Colour	€
40582	6	13		17,20



Salzmühle „CLARITY“

salt mill
molinillo de sal
moulin à sel



Mahlwerk aus Edelstahl, Mahlgrad stufenlos einstellbar

mill in stainless steel, grinding degree infinitely adjustable
molinillo de acero inoxidable, Molienda ajustable de forma continua
moulin en acier inox, réglée de façon continue tige en acier inox

	Ø cm	↑ cm	Farbe / Colour	€
40583	6	13		17,20

P

**Pfeffermühle „FRIDA“**

pepper mill
 molinillo de pimienta
 moulin à poivre

**Mahlwerk aus Carbonstahl, Mahlgrad stufenlos einstellbar**

mill in carbon steel, the grinding degree can be adjusted infinitely
 molinillo de acero al carbono, el grado de molino se puede ajustar de modo continuo
 moulin en acier de carbone, la finesse de mouture se peut réglée de façon continue

	Ø cm	↑ cm	€
40549	6	15,5	18,40

S

**Salzmühle „FRIDA“**

salt mill
 molinillo de sal
 moulin à sel

**Mahlwerk aus Edelstahl, Mahlgrad stufenlos einstellbar**

mill in stainless steel, the grinding degree can be adjusted infinitely
 molinillo de acero inoxidable, el grado de molino se puede ajustar de modo continuo
 moulin en acier inox, la finesse de mouture se peut réglée de façon continue

	Ø cm	↑ cm	€
40550	6	15,5	18,40

P

**Pfeffermühle „COPPER“**

pepper mill
 molinillo de pimienta
 moulin à poivre

**Mahlwerk aus Carbonstahl, Mahlgrad stufenlos einstellbar**

mill in carbon steel, the grinding degree can be adjusted infinitely
 molinillo de acero al carbono, el grado de molino se puede ajustar de modo continuo
 moulin en acier de carbone, la finesse de mouture se peut réglée de façon continue

	Ø cm	↑ cm	€
40551	6	15	17,00

S

**Salzmühle „COPPER“**

salt mill
 molinillo de sal
 moulin à sel

**Mahlwerk aus Edelstahl, Mahlgrad stufenlos einstellbar**

mill in stainless steel, the grinding degree can be adjusted infinitely
 molinillo de acero inoxidable, el grado de molino se puede ajustar de modo continuo
 moulin en acier inox, la finesse de mouture se peut réglée de façon continue

	Ø cm	↑ cm	€
40552	6	15	17,00

SALT- / PEPPER MILLS



Pfeffermühle „CLEARGRIND“

pepper mill
molinillo de pimienta
moulin à poivre



Mahlgrad stufenlos einstellbar

the grinding degree can be adjusted infinitely
el grado de molino se puede ajustar de modo continuo
la finesse de mouture se peut réglée de façon continue

	Ø cm	↑ cm	€
40540	5,5	15	20,30

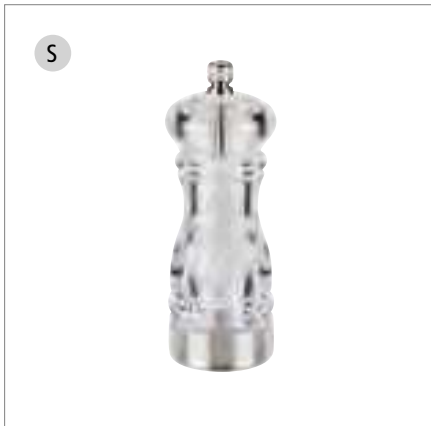

Salzmühle „CLEARGRIND“

salt mill
molinillo de sal
moulin à sel



Mahlgrad stufenlos einstellbar

the grinding degree can be adjusted infinitely
el grado de molino se puede ajustar de modo continuo
la finesse de mouture se peut réglée de façon continue

	Ø cm	↑ cm	€
40541	5,5	15	20,30



Pfeffermühle „DIAMOND“

pepper mill
molinillo de pimienta
moulin à poivre



Mahlwerk aus Carbonstahl, Mahlgrad stufenlos einstellbar

mill in carbon steel, the grinding degree can be adjusted infinitely
molinillo de acero al carbono, el grado de molino se puede ajustar de modo continuo
moulin en acier de carbone, la finesse de mouture se peut réglée de façon continue

	Ø cm	↑ cm	€
40553	6	18	17,00



Salzmühle „DIAMOND“

salt mill
molinillo de sal
moulin à sel



Mahlwerk aus Edelstahl, Mahlgrad stufenlos einstellbar

mill in stainless steel, the grinding degree can be adjusted infinitely
molinillo de acero inoxidable, el grado de molino se puede ajustar de modo continuo
moulin en acier inox, la finesse de mouture se peut réglée de façon continue

	Ø cm	↑ cm	€
40554	6	18	17,00



Naturschieferplatte / Untersetzer

natural slate tray
bandeja de pizarra natural
plateau ardoise naturelle



mit 2 Aussparungen Ø 6 cm / with 2 holes Ø 6 cm / con 2 agujeros Ø 6 cm / avec 2 trous Ø 6 cm

	cm	✦ mm	€
00971	15 x 8	6 - 9	3,40

2 IN 1 MILLS



40561



40562



40563



40543

2 in 1 Salz und Pfeffermühle „BOOGIE“

2 in 1 salt and pepper mill
2 en 1 molinillo sal y pimienta
2 en 1 moulin à sel et poivre

Keramikhahlwerk, Mahlgrad einstellbar

ceramic grinder, adjustable grinding degree

molinillo de cerámica, grado de molienda ajustable

moulin en céramique, degré de mouture réglable



	cm	↑ cm	Farbe / Colour	€
40561	6 x 5	8		15,40
40562	6 x 5	8		15,40
40563	6 x 5	8		15,40
40543	6 x 5	8		15,40



Mahlgrad einstellbar
adjustable grinding degree

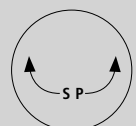

2 IN 1 MILLS



2 in 1 Salz- und Pfeffermühle „FLIPMILL“

2 in 1 salt and pepper mill
2 in 1 molinillo de sal y pimienta
2 in 1 moulin à sel et poivre



Keramik Mahlwerk / ceramic mechanism / molinillo de cerámica / broyeur en céramique

	cm	↑ cm	€
40544	6 x 4,5	9,5	21,00



Mahlgrad einstellbar
grinder setting

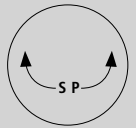

2 in 1 Salz- und Pfeffermühle „SPICEX“

2 in 1 salt and pepper mill
2 in 1 molinillo de sal y pimienta
2 in 1 moulin à sel et poivre



Keramik Mahlwerk / ceramic mechanism / molinillo de cerámica / broyeur en céramique

	Ø cm	↑ cm	€
40545	7,5	18,5	23,00



Mahlgrad einstellbar
grinder setting

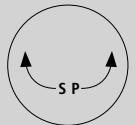

Allzweckstreuer, 12er Set

shaker, 12 pcs.
dosificador, set de 12
salières/poivrières, set de 12



	cm	↑ cm	pcs.	€ / set	
40504	4 x 4	10	12	13 Löcher / 13 holes 13 agujeros / 13 trous	23,40

	Ø cm	↑ cm	pcs.	€ / set	
40505	3	9	12	3 Löcher / 3 holes 3 agujeros / 3 trous	18,60



40501 - 2er Set
1 Salz- und
1 Pfefferstreuer

40507 - 2er Set
1 Salz- und 1 Pfefferstreuer

Salz- und Pfefferstreuer, 2er Set
salt - and pepper shaker, 2 pcs.
piezas de sal y pimienta, set de 2
sel et poivre, set de 2



	Ø cm	↑ cm	pcs.		€ / set
40501	5	6,5	2	geriffelte Ausführung / fluted version	3,20
40507	6	10,0	2		10,40



Ministreuer, 4er Set
mini shaker, 4 pcs.
dosificador mini, set de 4
mini-salières, set de 4



	Ø cm	↑ cm	pcs.		€ / set
40503	3,5	4	4		6,00



inkl.
Staubdeckel

Netzstreuer
mesh top shaker
polvoreador, tapa con malla fina
pot à épices, couvercle toile fine



	Ø cm	↑ cm	ltr.		€
00776	5,5	7,5	0,15		5,60



Löcher Ø 1 mm
inkl. Staubdeckel

Streuer fein
small hole shaker
polvoreador, tapa con agujeros pequeños
pot à épices, couvercle à petits trous



	Ø cm	↑ cm	ltr.		€
00777	5,5	7,5	0,15		5,00

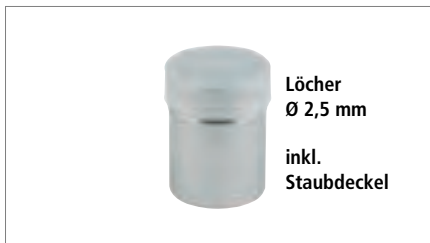

Löcher
Ø 2,5 mm
inkl.
Staubdeckel

Streuer grob
large hole shaker
polvoreador, tapa con agujeros grandes
pot à épices, couvercle à grands trous



	Ø cm	↑ cm	ltr.		€
00778	5,5	7,5	0,15		5,00



Löcher
Ø 5 mm
inkl.
Staubdeckel

Käse- oder Gewürzstreuer
spice shaker
bote especiero
saupoudreuse à épices



	Ø cm	↑ cm	ltr.		€
00775	5,5	7,5	0,15		5,60



00779

00772

Salzstreuer
salt shaker
salero
salière



Pommes-Frites Streuer mit Schraubkappe / for french fries, cover to screw / para patatas fritas, tapa de rosca / pour les frites, couvercle à visser

	Ø cm	↑ cm		€
00779	8	17	Aluminium / aluminium	9,90
00772	8	17	Edelstahl / stainless steel	15,00

TABLE CADDYS



Holzbox „WOODY“

woodbox
caja madera
base bois



Akazienholz, 4-Fächer: 12,5 x 8 cm / acacia wood, 4 compartements: 12,5 x 8 cm
madera de acacia, 4 compartimentos: 12,5 x 8 cm / bois d'acacia, 4 compartiments : 12,5 x 8 cm

	cm	↑ cm	€
11649	36 x 14	12,5	16,80



Servierbeispiel
Lieferung ohne Gläser
delivery without glasses

Holzbox „TABLE“

woodbox
caja madera
base bois



Akazienholz, 3 Fächer: 6,5 x 6,5 cm / acacia wood, 3 compartiments: 6,5 x 6,5 cm
madera de acacia, 3 compartimentos: 6,5 x 6,5 cm / bois d'acacia, 3 compartiments : 6,5 x 6,5 cm

	cm	↑ cm	€
11727	23,5 x 8,5	4,5	13,60



Holzbox „TABLE“

woodbox
caja madera
base bois



Akazienholz, 1 Fach: 12 x 6,5 cm
acacia wood, 1 compartiment: 12 x 6,5 cm
madera de acacia, 1 compartimento: 12 x 6,5 cm
bois d'acacia, 1 compartiment: 12 x 6,5 cm

	cm	↑ cm	€
11726	15,0 x 9,5	5	9,90



Table Caddy

table caddy
caddy de mesa
caddy de table



Akazienholz, 1 Fach: 21,5 x 8 cm
acacia wood, 1 compartiment: 21,5 x 8 cm
madera de acacia, 1 compartimento: 21,5 x 8 cm
bois d'acacia, 1 compartiment: 21,5 x 8 cm

	cm	↑ cm	€
11625	23 x 10	10	11,20



Holzbox „WOODY“

woodbox
caja madera
base bois



Akazienholz, 1 Fach: 13 x 13 cm
acacia wood, 1 compartiment: 13 x 13 cm
madera de acacia, 1 compartimento: 13 x 13 cm
bois d'acacia, 1 compartiment : 13 x 13 cm

	cm	↑ cm	€
11650	15,0 x 15	5,5	12,50

Akazienholz, 2 Fächer: 13,5 x 13 cm / 6,5 x 13 cm
acacia wood, 2 compartiments: 13,5 x 13 cm / 6,5 x 13 cm
madera de acacia, 2 compartimentos: 13,5 x 13 cm / 6,5 x 13 cm
bois d'acacia, 2 compartiments : 13,5 x 13 cm / 6,5 x 13 cm

	cm	↑ cm	€
11651	22,5 x 15	5,5	15,70

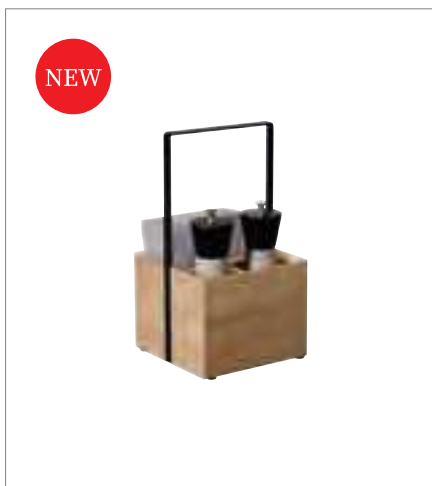

NEW

Table Caddy „VALO“

table caddy
caddy de mesa
caddy de table



Eichenholz (geölt), 3 Fächer, mit Antirutsch-Füßchen
oak wood (oiled), 3 compartments, with non-slip feet
madera de roble (aceitada), 3 compartimentos, con pies antideslizantes
bois de chêne (huilé), 3 compartiments, avec pieds antidérapants

	cm	↑ cm	€
14090	15 x 15	28	66,00



NEW

Table Caddy „VALO“

table caddy
caddy de mesa
caddy de table



Eichenholz (geölt), 3 Fächer, mit Antirutsch-Füßchen
oak wood (oiled), 3 compartments, with non-slip feet
madera de roble (aceitada), 3 compartimentos, con pies antideslizantes
bois de chêne (huilé), 3 compartiments, avec pieds antidérapants

	cm	↑ cm	€
14091	15 x 15	31	89,00



40516

40517

Snackspender „NOTOUCH“

snack dispenser
dispensador de snacks
distributeur de snacks



Behälter aus Glas, Schraubdeckel aus Edelstahl, Öffnung oval 3,5 x 2,5 cm
glass container, stainless steel screw cap, opening oval 3,5 x 2,5 cm
recipiente de cristal, tapón de rosca de acero inoxidable, apertura ovalada 3,5 x 2,5 cm
récipient en verre, couvercle à visser en acier inox, ouverture ovale 3,5 x 2,5 cm

	Ø cm	↑ cm	ltr.	Farbe / Colour	€
40516	8,5	15,5	0,35		8,40
40517	8,5	15,5	0,35		8,40

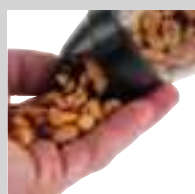

BUTTER DISHES



Butterservierer

butter dish
mantequillera
beurrier



hochglanzpoliert / mirror polished / acabado brillante / poli brillant

	Ø cm	↑ cm	ltr.	€
15921	9	7	0,06	16,80

Butterservierer ohne Deckel

butter server without lid
servidor de mantequilla sin tapa
pelle à beurre sans couvercle

	Ø cm	↑ cm	€
15922	9	4	4,80



Butterservierer

butter dish
mantequillera
beurrier



	cm	↑ cm	ltr.	€
15925	Ø 9	9	0,07	9,20
15926	9 x 9	9	0,075	9,20



Schale „ENAMELWARE“

bowl
cuenco
bol



	cm	↑ cm	ltr.	€
40667	16 x 12,0	3,5	0,20	7,90
40668	18 x 13,5	4,0	0,35	8,60



Butterdose

butter dish
mantequillera
boîte à beurre



	cm	↑ cm	€
00063	16 x 9,5	5,5	4,20



Marmordose, 2er Set „MARVELLO“

marble box, 2 pcs.
caja de mármol, set de 2
boîte en marbre, set de 2

ideal geeignet für Butter oder Gewürze
ideal for butter or spices
ideal para mantequilla o especias
idéal pour le beurre ou les épices



	Ø cm	↑ cm	ltr.	pcs.	€/ set
15920	6	5	0,04	2	19,00

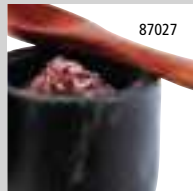

Eierbecher, 4er Set „EGGY“

egg holder, 4 pcs. set
huevera, set de 4
coquetier, set de 4



	Ø cm	↑ cm	pcs.	Farbe / Colour	€/ set
85295 <small>new</small>	8,5	2	4	green matt	8,40
85296 <small>new</small>	8,5	2	4	grey matt	8,40
83849	8,5	2	4	black matt	8,40
83848	8,5	2	4	white shiny	8,40



Eierbecher, 4er Set

egg holder, 4 pcs. set
huevera, set de 4
coquetier, set de 4



	Ø cm	↑ cm	pcs.	Farbe / Colour	€/ set
83851	8	3	4	white shiny	8,60



Eierbecher

egg holder
huevera
coquetier



	Ø cm	↑ cm	€
00032	8,5	2	1,60

NEW

ALLURE



Gießer, 4er Set „ALLURE“

pourer, set of 4
vertedor, set de 4
pichet, set de 4



hochglanzpoliert, für Kaffeesahne, Milch, Dessertsaucen, etc., tropffreies Ausgießen
highly polished, for coffee cream, milk, dessert sauces, etc., drip-free pouring
pulido brillante, para crema de café, leche, salsas de postre, etc., vertido sin goteo
poli brillant, pour crème à café, lait, sauces à dessert, etc., verser sans goutter

	ø cm	↑ cm	ltr.	Farbe / Colour		pcs.	€ / set
10300	4,5	4,0	0,03		stainless steel	4	11,80
10302	3,5	4,5	0,04		stainless steel	4	12,40



Gießer, 4er Set „ALLURE“

pourer, set of 4
vertedor, set de 4
pichet, set de 4



hochglanzpoliert, für Kaffeesahne, Milch, Dessertsaucen, etc., tropffreies Ausgießen
highly polished, for coffee cream, milk, dessert sauces, etc., drip-free pouring
pulido brillante, para crema de café, leche, salsas de postre, etc., vertido sin goteo
poli brillant, pour crème à café, lait, sauces à dessert, etc., verser sans goutter

	ø cm	↑ cm	ltr.	Farbe / Colour		pcs.	€ / set
10301	4,5	4,0	0,03		copper look (PVD)	4	13,00
10303	3,5	4,5	0,04		copper look (PVD)	4	13,60



NEW **FLOW**



10305



10306



10307

Gießer „FLOW“

pouzer
vertedor
pichet

Vintage-Look, für Saucen, Dressings, etc.
vintage look, for sauces, dressings, etc.
look vintage, para salsas, aliños, etc.
look vintage, pour sauces, vinaigrettes, etc.



	ø cm	↑ cm	ltr.	Farbe / Colour	€
10305	6	6,5	0,15	 vintage-look	8,80
10306	6	6,5	0,15	 vintage-look gold (PVD)	8,80
10307	6	6,5	0,15	 vintage-look copper (PVD)	8,80



GRAVY BOATS



40208



40204



40205



40206

Sauciere „PROFI“

gravy boat
salsera
saucière



hochglanzpoliert, extra schwere Qualität
mirror polished, high quality
pulido brillante, alta calidad, base pesada
poli brillant, belle qualité, pied pesant

	cm	↑ cm	ltr.	€
40208	13 x 6,0	9,0	0,075	6,60
40204	16 x 7,5	9,0	0,125	7,60
40205	19 x 9,0	13,0	0,25	9,90
40206	22 x 10,5	13,5	0,4	12,00



Thermo-Sauciere
insulated sauce boat
salsera isotérmica
saucière thermique



doppelwandig, Klapptdeckelverschluss, Einhandbedienung
double wall, hinged cover, one-hand operation
doble pared, tapa con bisagra, se maneja con 1 mano
double paroi, couvercle avec charnière, usage 1 main

	cm	↑ cm	ltr.	€
40207	19 x 12,5	13	0,4	16,00



Glocke
cloche / dome cover
campana esférica
cloche demi-sphère



außen hochglanzpoliert, innen matt poliert, mit verchromten Griff
outside mirror polished, inside matt polished, with chromeplated handle
exterior pulido brillante, interior pulido mate, pomo cromado
extérieur poli brillant, intérieur poli mat, buton chromé

	Ø cm	↑ cm	€
35734	29	18	56,00



Platzteller
plate tray
bajo plato
assiette de présentation



hochglanzpoliert, mit Fadendekor
mirror polished, with line edge
pulido brillante, con un filo en relieve
poli brillant, filet relief

	Ø cm	€
35730	30,5	15,20
36233	33,0	21,00



Platzteller
plate tray
bajo plato
assiette de présentation



hochglanzpoliert, mit Perlrand
mirror polished, with pearl edge
acabado pulido brillante, con borde aperlado
poli brillant, bord perlé

	Ø cm	€
35720	30,5	15,40
36323	33,0	18,20



Tischkrümelentferner
crumber
recogemigas
ramasse-miettes



matt poliert, geschliffene Edelstahlkante
matt polished, flat grinded stainless steel edge
pulido mate, borde plano de acero inoxidable rectificado
poli mat, bord plat rectifié en acier inox

	cm	↑ cm	€
00581	19,0 x 4,5	1	8,00

COASTERS



Untersetzer, 6er Set

coaster, 6 pcs.
posavasos, set de 6
plateau sous-verre, set de 6

hochglanzpoliert, schwere Ausführung, Rand eingerollt
mirror polished, heavy quality, rolled edge
pulido brillante, alta calidad, borde redondeado
poli brillant, bord rond, qualité extra

EDELSTAHL
STAINLESS
INOX
18/8



	Ø cm	pcs.	€ / set
35711	10	6	22,00
35912	12	6	17,00



Serviettenringe, 4er Set

napkin rings, 4 pcs.
servilleteros, set de 4
anneaux porte-serviette, set de 4

EDELSTAHL
STAINLESS
INOX
18/8



	Ø cm	↑ cm	pcs.	€ / set
04446	4,5	2,5	4	8,40



Rechnungstablett

bill presenter
porta cuenta
porte-addition

mit Klemme für Rechnung
with clip for bill
con clip para la nota
avec clip pour la note

EDELSTAHL
STAINLESS
INOX



	cm	↑ cm	€
30110	17 x 11	1,0	6,30



Rechnungstablett

bill presenter
porta cuenta
porte-addition

mit Klemme für Rechnung
with clip for bill
con clip para la nota
avec clip pour la note

ABS
KUNSTSTOFF



	cm	↑ cm	€
30108	20 x 12	0,5	2,40

PERFECTION



UNZERBRECHLICH
UNBREAKABLE



Trinkglas „PERFECTION“

drinking glass
vaso de agua
verre à boire



	Ø cm	↑ cm	ltr.	VE / unit	€ / pc.
10543	8	11,5	0,33	12	6,60



Trinkglas „PERFECTION“

drinking glass
vaso de agua
verre à boire



	Ø cm	↑ cm	ltr.	VE / unit	€ / pc.
10544	8	15	0,47	12	7,40



Sektglas „PERFECTION“

champagne glasses
copa de champán
flûte à champagne



	Ø cm	↑ cm	ltr.	VE / unit	€ / pc.
10540	5	23	0,19	12	6,40



Weißweinglas „PERFECTION“

white wine glasses
copa de vino blanco
verre à vin blanc



	Ø cm	↑ cm	ltr.	VE / unit	€ / pc.
10541	8	21,5	0,32	12	7,60



Rotweinglas „PERFECTION“

red wine glasses
copa de vino tinto
verre à vin rouge



	Ø cm	↑ cm	ltr.	VE / unit	€ / pc.
10542	10,5	21	0,6	12	8,60



PLACEMATS



Tischset
placemat
mantelín
set de table



	cm		VE / unit	€/ pc.
60580	45 x 33	beige / beige	24	6,60



rutschhemmende Unterseite
non-slip bottom



Tischset
placemat
mantelín
set de table



	cm		VE / unit	€/ pc.
60581	45 x 33	grün / green	24	6,60



rutschhemmende Unterseite
non-slip bottom

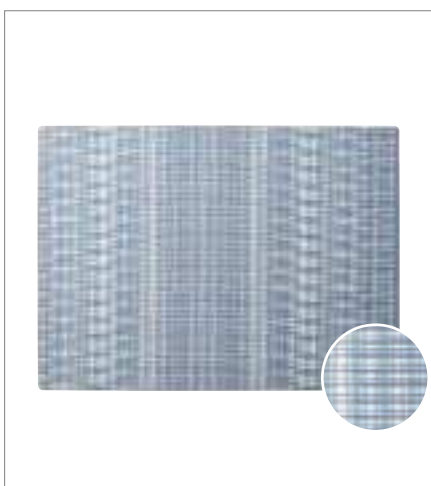

Tischset
placemat
mantelín
set de table



	cm		VE / unit	€/ pc.
60582	45 x 33	blau / blue	24	6,60



rutschhemmende Unterseite
non-slip bottom



Tischset
placemat
mantelín
set de table



	cm		VE / unit	€ / pc.
60584	45 x 33	beige / beige	24	6,60



rutschhemmende Unterseite
non-slip bottom



Tischset
placemat
mantelín
set de table



	cm		VE / unit	€ / pc.
60583	45 x 33	anthrazit / anthracite	24	6,60



rutschhemmende Unterseite
non-slip bottom

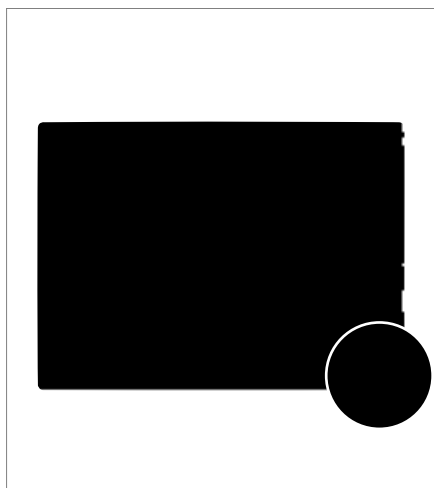

Tischset
placemat
mantelín
set de table



	cm		VE / unit	€ / pc.
60585	45 x 33	grün / green	24	6,60

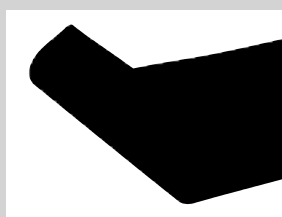

rutschhemmende Unterseite
non-slip bottom

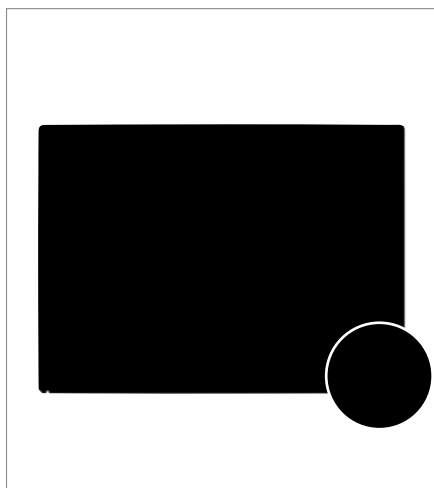

Tischset
placemat
mantelín
set de table



	cm		VE / unit	€ / pc.
60586	45 x 33	dunkelblau / dark blue	24	6,60



rutschhemmende Unterseite
non-slip bottom

PLACEMATS



Die umgelegten und angenähten Kanten machen diese Tischsets besonders robust. Geliefert in einer 6er Einheit.

The folded and sewn edges make these table sets particularly robust. Delivered in a packing unit of 6 pieces.

Los bordes doblados y cosidos de los mantelitos los hacen especialmente resistentes. Se entregan en una unidad de embalaje de 6 piezas.

Les bords repliés et cousus rendent ces sets de table en particulierement robustes. Livré dans un emballage de 6 pièces.



Warenträger - Tischsets

display for placemats
expositor para mantelinas de mesa
présentoir pour sets de table

12 Einschubfächer, komplett auf Rollen, 2 Feststellrollen, Lieferung demontiert

12 shelves, on rolls, 2 rolls to fix, delivery unassembled

12 niveles, 4 ruedas, desmontado (montaje fácil)

12 niveaux, 4 roues, livré démonté

	cm	↑ cm
00401	39,5 x 45	165

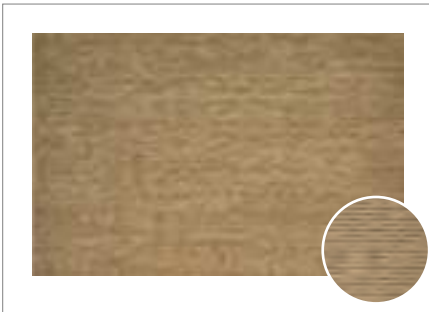

Tischset Feinband „TAO“

placemat fine band
mantelín cinta fina
set de table, tressage fin



	cm		VE / unit	€ / pc.
60503	45 x 33	beige / beige	6	4,20

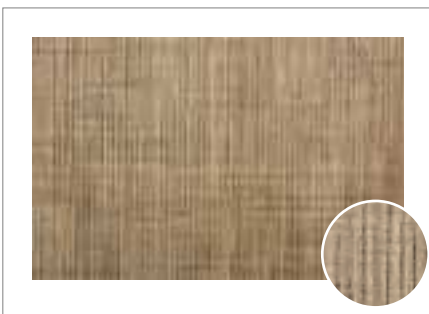

Tischset Feinband

placemat fine band
mantelín cinta fina
set de table, tressage fin



	cm		VE / unit	€ / pc.
60038	45 x 33	beige braun / beige brown	6	3,30



Tischset Feinband

placemat fine band
mantelín cinta fina
set de table, tressage fin



	cm		VE / unit	€ / pc.
60037	45 x 33	gold / gold	6	3,30

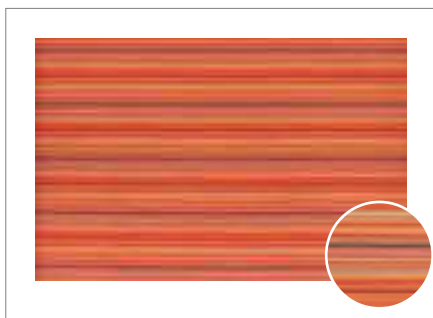

Tischset Feinband
 placemat fine band
 mantelín cinta fina
 set de table, tressage fin



	cm		VE / unit	€ / pc.
60511	45 x 33	LINES orange, gelb / LINES orange yellow	6	3,30



Tischset Feinband
 placemat fine band
 mantelín cinta fina
 set de table, tressage fin



	cm		VE / unit	€ / pc.
60510	45 x 33	LINES orange, rot / LINES orange red	6	3,30

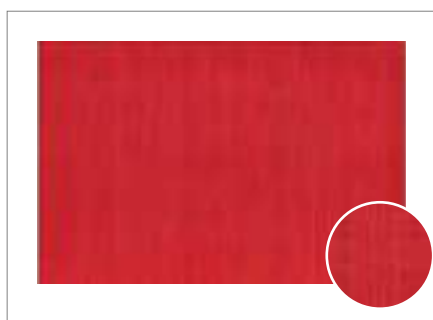

Tischset Feinband
 placemat fine band
 mantelín cinta fina
 set de table, tressage fin



	cm		VE / unit	€ / pc.
60542	45 x 33	rot / red	6	3,30

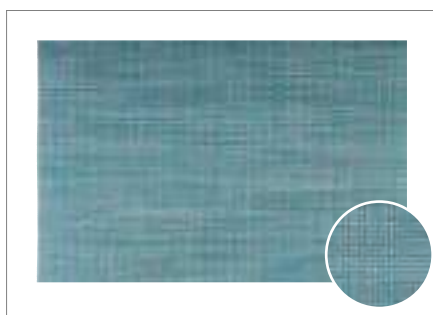

Tischset Feinband
 placemat fine band
 mantelín cinta fina
 set de table, tressage fin



	cm		VE / unit	€ / pc.
60042	45 x 33	türkis, grün, weiß / turquoise, green, white	6	3,30

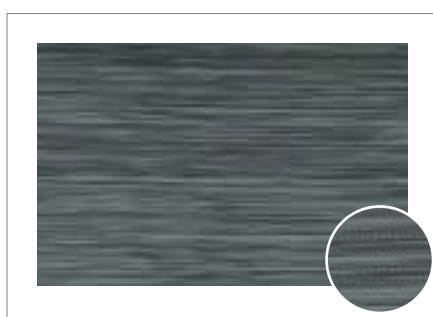

Tischset Feinband „TAO“
 placemat fine band
 mantelín cinta fina
 set de table, tressage fin



	cm		VE / unit	€ / pc.
60508	45 x 33	hellblau, dunkelblau / light blue, dark blue	6	4,70

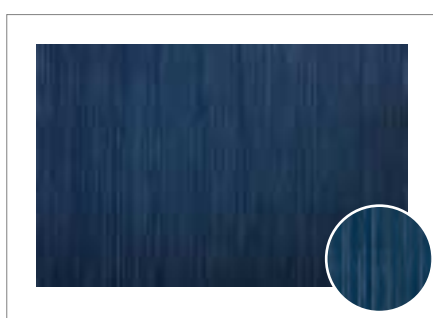

Tischset Feinband
 placemat fine band
 mantelín cinta fina
 set de table, tressage fin



	cm		VE / unit	€ / pc.
60040	45 x 33	blau / blue	6	3,30

PLACEMATS

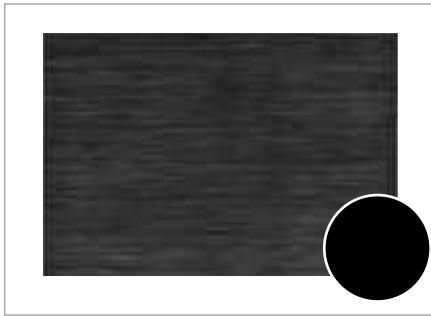

Tischset Feinband
 placemat fine band
 mantelín cinta fina
 set de table, tressage fin



	cm		VE / unit	€ / pc.
60512	45 x 33	schwarz, grau / black, grey	6	3,30



Tischset Feinband
 placemat fine band
 mantelín cinta fina
 set de table, tressage fin



	cm		VE / unit	€ / pc.
60530	45 x 33	STRIPES grau / STRIPES grey	6	3,30

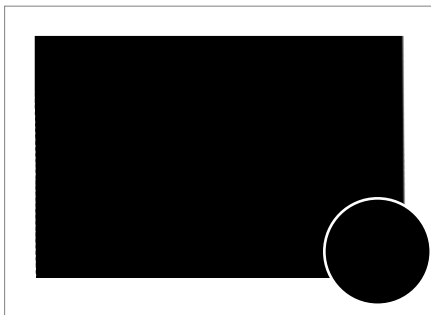

Tischset Feinband
 placemat fine band
 mantelín cinta fina
 set de table, tressage fin



	cm		VE / unit	€ / pc.
60540	45 x 33	FRAMES grau / FRAMES grey	6	3,30

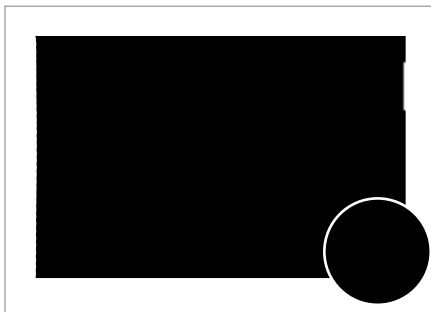

Tischset Feinband
 placemat fine band
 mantelín cinta fina
 set de table, tressage fin



	cm		VE / unit	€ / pc.
60541	45 x 33	FRAMES schwarz / FRAMES black	6	3,30



Tischset Schmalband
 placemat smallband
 mantelín cinta estrecha
 set de table tressage étroit



	cm		VE / unit	€ / pc.
60014	45 x 33	beige / beige	6	3,30

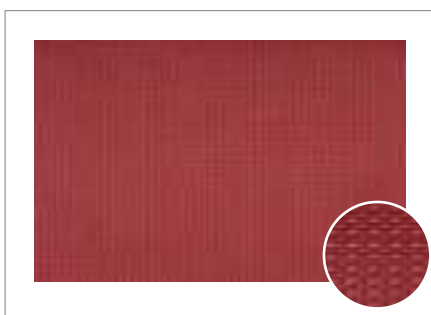

Tischset Schmalband
 placemat smallband
 mantelín cinta estrecha
 set de table tressage étroit



	cm		VE / unit	€ / pc.
60522	45 x 33	rot / red	6	3,30

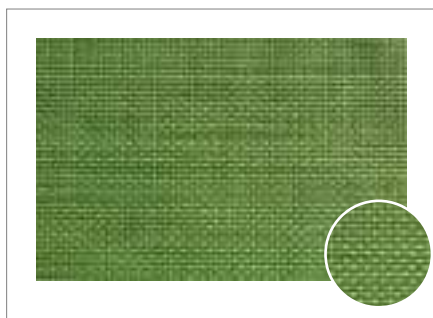

Tischset Schmalband
 placemat smallband
 mantelín cinta estrecha
 set de table tressage étroit



cm			VE / unit	€ / pc.
60521	45 x 33	apfelgrün / apple green	6	3,30

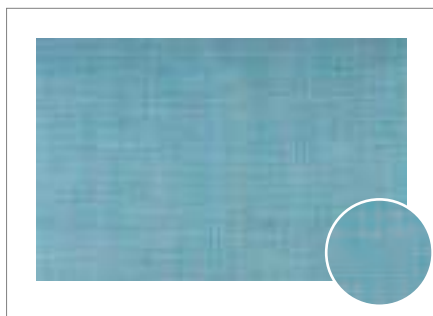

Tischset Schmalband
 placemat smallband
 mantelín cinta estrecha
 set de table tressage étroit



cm			VE / unit	€ / pc.
60041	45 x 33	hellblau, weiß / light blue, white	6	3,30

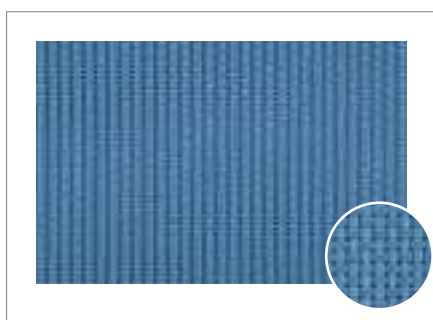

Tischset Schmalband
 placemat smallband
 mantelín cinta estrecha
 set de table tressage étroit



cm			VE / unit	€ / pc.
60002	45 x 33	hellblau / light blue	6	3,30



Tischset Schmalband
 placemat smallband
 mantelín cinta estrecha
 set de table tressage étroit



cm			VE / unit	€ / pc.
60527	45 x 33	silber / silver	6	3,30

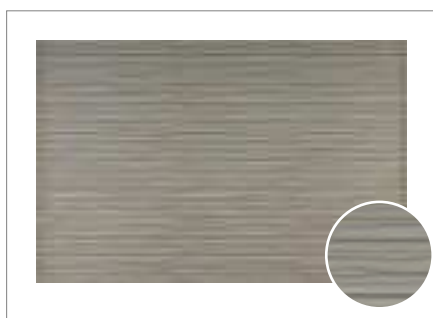

Tischset Schmalband
 placemat smallband
 mantelín cinta estrecha
 set de table tressage étroit



cm			VE / unit	€ / pc.
60525	45 x 33	weiß / white	6	3,30

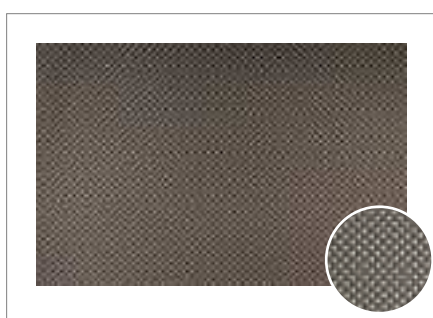

Tischset Schmalband
 placemat smallband
 mantelín cinta estrecha
 set de table tressage étroit



cm			VE / unit	€ / pc.
60524	45 x 33	platin / platinum	6	3,30

PLACEMATS

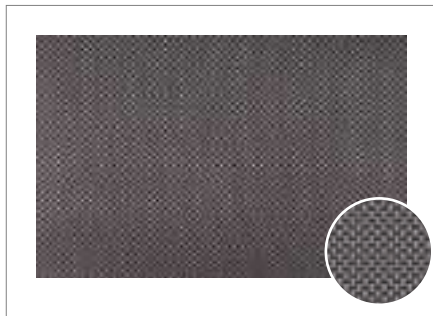

Tischset Schmalband
 placemat smallband
 mantelín cinta estrecha
 set de table tressage étroit



	cm		VE / unit	€ / pc.
60015	45 x 33	silbergrau / silvergrey	6	3,30



Tischset Schmalband
 placemat smallband
 mantelín cinta estrecha
 set de table tressage étroit



	cm		VE / unit	€ / pc.
60526	45 x 33	gold / gold	6	3,30

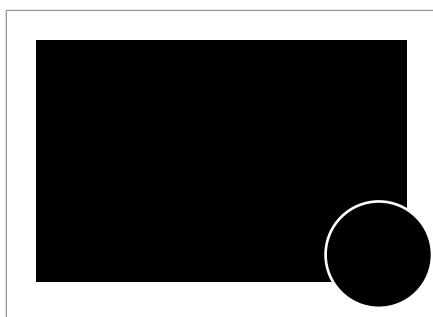

Tischset Schmalband
 placemat smallband
 mantelín cinta estrecha
 set de table tressage étroit



	cm		VE / unit	€ / pc.
60019	45 x 33	beige braun / beige brown	6	3,30

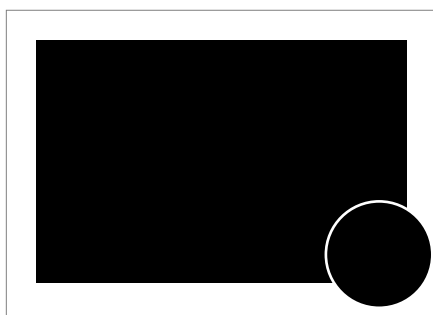

Tischset Schmalband
 placemat smallband
 mantelín cinta estrecha
 set de table tressage étroit



	cm		VE / unit	€ / pc.
60012	45 x 33	schwarz / black	6	3,30

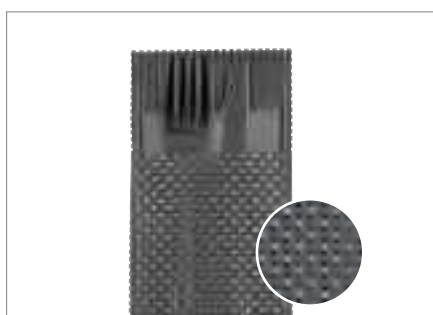

Servietten- und Bestecktaschen, 6er Set
 cutlery bag, 6 pcs. set
 bolsa cubiertos, set de 6
 pochette couverts, set de 6



	cm		pcs.	€ / set
60551	24 x 9	silbergrau / silvergrey	6	4,20



Servietten- und Bestecktaschen, 6er Set
 cutlery bag, 6 pcs. set
 bolsa cubiertos, set de 6
 pochette couverts, set de 6



	cm		pcs.	€ / set
60552	24 x 9	beige braun / beige brown	6	4,20

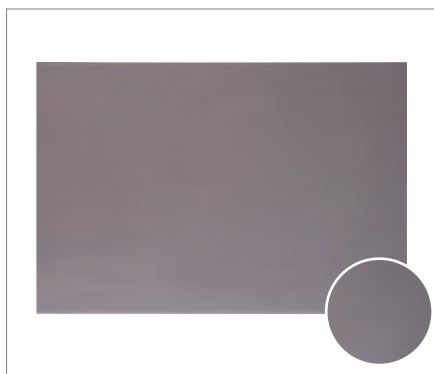

Tischset
placemat
mantelín
set de table



Kunstleder, mit Naht rundherum
imitation leather, with seam all around
imitación de cuero, con costura alrededor
similicuir, avec couture tout autour

cm			VE / unit	€ / pc.
60044	45 x 32,5	grau / grey	6	11,60

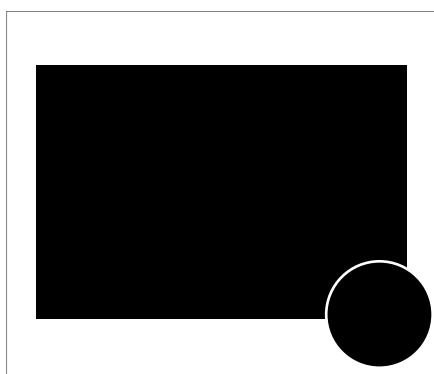

Tischset
placemat
mantelín
set de table



Kunstleder, mit Naht rundherum
imitation leather, with seam all around
imitación de cuero, con costura alrededor
similicuir, avec couture tout autour

cm			VE / unit	€ / pc.
60045	45 x 32,5	braun / brown	6	11,60

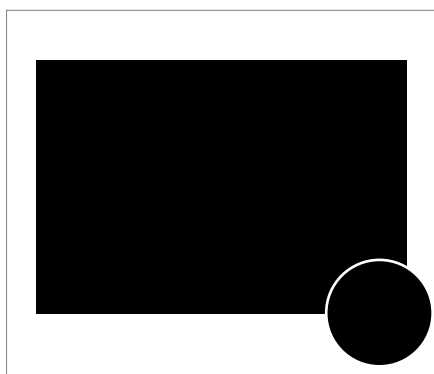

Tischset
placemat
mantelín
set de table



Kunstleder, mit Naht rundherum
imitation leather, with seam all around
imitación de cuero, con costura alrededor
similicuir, avec couture tout autour

cm			VE / unit	€ / pc.
60046	45 x 32,5	schwarz / black	6	11,60

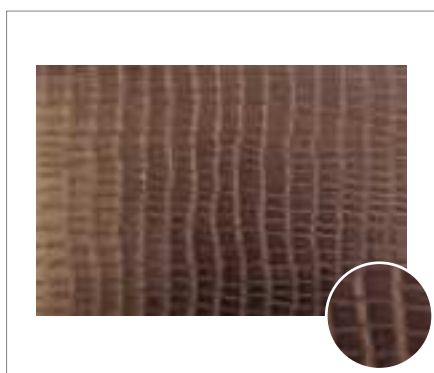

Tischset „CROCO“
placemat
mantelín
set de table



rutschhemmende Unterseite
slip resistant underside
parte inferior antideslizante
dessous antidérapant

cm			VE / unit	€ / pc.
60536	45 x 30	kupfer / copper	6	5,50



60044
Kunstleder, mit Naht rundherum
imitation leather, with seam all around

NEW ALLURE



Gießer, 4er Set „ALLURE“

pourer, set of 4
vertedor, set de 4
pichet, set de 4



Edelstahl hochglanzpoliert, für Kaffeesahne, Milch, Dessertsaucen, etc., tropffreies Ausgießen
stainless steel highly polished, for coffee cream, milk, dessert sauces, etc., drip-free pouring
acero inoxidable pulido brillante, para crema de café, leche, salsas de postre, etc., vertido sin goteo
acier inox poli brillant, pour crème à café, lait, sauces à dessert, etc., verser sans goutter

	ø cm	↑ cm	ltr.	Farbe / Colour		pcs.	€/ set
10300	4,5	4,0	0,03		stainless steel	4	11,80
10302	3,5	4,5	0,04		stainless steel	4	12,40



Gießer, 4er Set „ALLURE“

pourer, set of 4
vertedor, set de 4
pichet, set de 4



Edelstahl hochglanzpoliert, für Kaffeesahne, Milch, Dessertsaucen, etc., tropffreies Ausgießen
stainless steel highly polished, for coffee cream, milk, dessert sauces, etc., drip-free pouring
acero inoxidable pulido brillante, para crema de café, leche, salsas de postre, etc., vertido sin goteo
acier inox poli brillant, pour crème à café, lait, sauces à dessert, etc., verser sans goutter

	ø cm	↑ cm	ltr.	Farbe / Colour		pcs.	€/ set
10301	4,5	4,0	0,03		copper look (PVD)	4	13,00
10303	3,5	4,5	0,04		copper look (PVD)	4	13,60





Milchkännchen, 4er Set

milk/cream jugs, 4 pcs.
pack de 4 jarritas para leche o crema
pack de 4 crémiers

hochglanzpoliert, für Kaffeesahne, mit Griff, Inhalt à 25 ml
mirror polished, for coffee-cream, with handle, capacity à 25 ml
pulido brillante, para crema de café, con asa, capacidad 25 ml
poli brillant, avec anse, 25 ml



	Ø cm	↑ cm	pcs.	ltr.	€ / set
10321	3,5	3,5	4	0,025	15,00



10318

Gießer „HANDLE“

pouyer
vertedor
verseur



	Ø cm	↑ cm	ltr.	€
10318	4	4	0,05	2,40
10319	5	5	0,09	3,00
10320	6	6	0,15	3,60



Allzweckgießer

pouyer
bote vertedor universal
pot verseur universel

für Honig, Kaffeesahne, etc., Schraubdeckel aus Edelstahl
for honey, cream, etc., cover stainless steel
para miel, crema, etc., tapa inoxidable
pour le miel, le lait, la crème, etc., couvercle inox



	Ø cm	↑ cm	ltr.	€
00765	8,5	13,5	0,3	9,00



5 tlg.
5 pcs.

00631

00634

Milch- und Zucker-Set „MILURO“

milk and sugar set
set de crema y azúcar
set lait et sucre

5-teilig: Tablett, Milchkanne, Zuckerdose mit Deckel, Löffel
5 pcs.: tray, milk jug, sugar bowl with lid, spoon
set de 5: bandeja, jarra de leche, azucarero con tapa, cuchara
set de 5: plateau, pichet à lait, sucrier avec couvercle, cuillère



	cm	↑ cm	Holz / Wood	€
00631 <small>NEW</small>	19 x 10	10	bamboo	27,00
00634	19 x 10	10	acacia	27,00

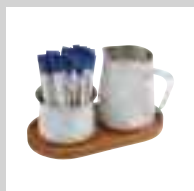

SUGAR DISPENSERS

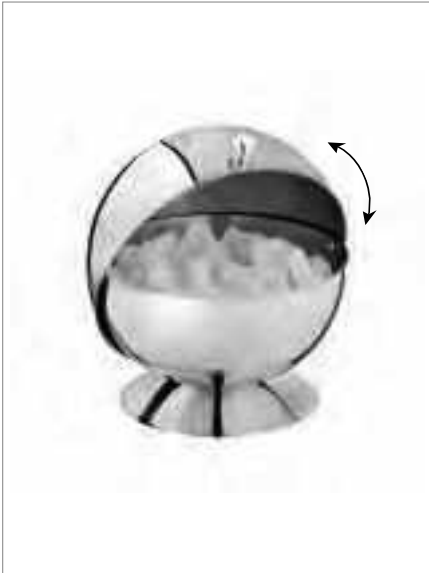

Zuckerkugel

sugar pot
azucarero
sucrier

hochglanzpoliert, mit Roldeckel

mirror polished, rolltop cover
pulido brillante, tapa abatible
poli brillant, couvercle abattant



	Ø cm	↑ cm	€
00033	13,5	15	14,40



Zuckerdosierer

sugar dispenser
azucarero
sucrier

Schraubdeckel aus Edelstahl, mit Dosierrohr

cover stainless steel, with dosing tube
tapa inoxidable y tubo, con tubo dosificador
couvercle inox et tube doseur



	Ø cm	↑ cm	ltr.	€
40509	6	14,5	0,2	12,00



Zuckerdosierer

sugar dispenser
azucarero
sucrier

Schraubdeckel aus Edelstahl / cover stainless steel / tapa inoxidable / couvercle inox



	Ø cm	↑ cm	ltr.	€
00766	8,5	15	0,3	5,50



Zuckerdosierer

sugar dispenser
azucarero
sucrier

Schraubdeckel aus Edelstahl, mit Dosierrohr

cover stainless steel, with dosing tube
tapa inoxidable y tubo dosificador
couvercle inoxydable et tube doseur



	Ø cm	↑ cm	ltr.	€
40506	7,5	17	0,32	5,40



Zuckerdosierer

sugar dispenser
azucarero
sucrier



Schraubdeckel aus Edelstahl, mit Dosierrohr
cover stainless steel, with dosing tube
tapa inoxidable y tubo, con tubo dosificador
couvreclé inox et tube doseur

	Ø cm	↑ cm	ltr.	€
40486	8	15	0,25	3,90



Zuckerdosierer

sugar dispenser
azucarero
sucrier



Schraubdeckel aus Edelstahl, mit Dosierrohr
cover stainless steel with dosing tube
tapa inoxidable y tubo dosificador
couvreclé inox et tube doseur

	Ø cm	↑ cm	ltr.	€
40490	8,5	12	0,15	3,90
40494	8,0	15	0,25	3,90



Zuckerdosierer

sugar dispenser
azucarero
sucrier



Schraubdeckel mit Klappe aus Edelstahl, mit Dosierklappe
cover stainless steel, with dosing flap
tapa acero inoxidable, con tubo dosificador
couvreclé inox, avec couvercle doseur

	Ø cm	↑ cm	ltr.	€
40487	7,5	13,5	0,32	4,80



Zuckerdosierer „OLD FASHIONED“

sugar dispenser
azucarero
sucrier



Schraubdeckel mit Klappe aus Edelstahl, mit Dosierklappe
cover stainless steel, with dosing flap
tapa acero inoxidable, con tubo dosificador
couvreclé inox, avec couvercle doseur

	Ø cm	↑ cm	ltr.	€
40510	7,5	14	0,35	4,40

MENU HOLDERS

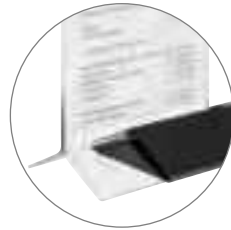

zum Einschieben der Speisekarten
- schneller Austausch jederzeit möglich!
for inserting the menus - quick exchange possible at any time!

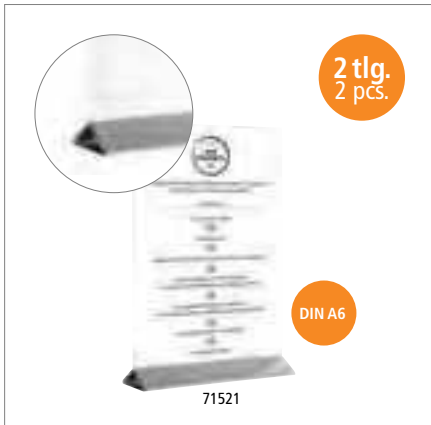

2 tlg.
2 pcs.

DIN A6

71521

Kartenhalter 2-teilig

menu holder, 2 pcs.
porta menús, set de 2
porte-cartes, set de 2

Fuß aus Edelstahl, Menühalter aus Acryl
stainless steel base, menu holder made of acrylic
base de acero inoxidable, porta menús acrílico
base en acier inox, porte-cartes en acrylique



	cm	↑ cm		€
71521	10,5 x 7	17	stainless steel	11,00
71527	10,5 x 7	17	black	11,00



2 tlg.
2 pcs.

DIN A5

71528

Kartenhalter 2-teilig

menu holder, 2 pcs.
porta menús, set de 2
porte-cartes, set de 2

Fuß aus Edelstahl, Menühalter aus Acryl
stainless steel base, menu holder made of acrylic
base de acero inoxidable, porta menús acrílico
base en acier inox, porte-cartes en acrylique



	cm	↑ cm		€
71522	15 x 7	23	stainless steel	13,60
71528	15 x 7	23	black	13,60



2 tlg.
2 pcs.

DIN A4

71523

Kartenhalter 2-teilig

menu holder, 2 pcs.
porta menús, set de 2
porte-cartes, set de 2

Fuß aus Edelstahl, Menühalter aus Acryl
stainless steel base, menu holder made of acrylic
base de acero inoxidable, porta menús acrílico
base en acier inox, porte-cartes en acrylique



	cm	↑ cm		€
71523	21 x 7	32	stainless steel	16,00
71529	21 x 7	32	black	16,00



Tafelhalter / Schild
 slate sign
 caballete de mesa, pizarra
 plaque signalétique avec support



	cm	↑ cm	pcs.	€
00060	12 x 4	7	1	7,80



Kartenhalter, 2er Set

table stands, 2 pcs.
 portatarjetas, set de 2
 porte-cartes, set de 2



inklusive 30 Beschriftungskarten ca. 10 x 8 cm (15 x weiß + 15 x schwarz)

including 30 labels 10 x 8 cm (15 x white + 15 x black)

incluye 30 tarjetas 10 x 8 cm (15 x blanco + 15 x negro)

inclut 20 étiquettes 10 x 8 cm (15 x blanc + 15 x noir)

	cm	↑ cm	pcs.	€/ set
71495	8 x 3,5	6	2	8,20



Tischkartenhalter

table stand
 soporte de mesa
 support de table



möbelschonende Unterseite

non-scratching undersurface

con base antirrayaduras

avec revêtement antirayures

	cm	↑ cm	€
00071	14 x 5,5	14	17,20

MENU HOLDERS



Mini Staffelei, 2 teilig

easel mini, 2 pcs.
caballete mini, set de 2
chevale mini, set de 2



Ständer aus Akazienholz, Schild kann senkrecht oder waagrecht verwendet werden

acacia wood stand, sign can be used vertically or horizontally

soporte de madera de acacia, el cartel se puede utilizar vertical u horizontalmente

support en bois d'acacia, le panneau peut être utilisé verticalement ou horizontalement

	cm	↑ cm	€
71520	13,5 x 10	19	8,90
71531	19,5 x 15	24	9,90



waagrecht
horizontal



senkrecht
vertical



71490 Kreide-Marker
chalk marker

Inhalt ohne Stift
content without pen



Tischkartenhalter

table stand
soporte-carta para la mesa
support pour menu de table



matt poliert
matt polished
pulido mate
poli mat

	cm	↑ cm	pcs.	€
00030	8 x 7,0	2	1	3,10
00036	6 x 4,5	4	1	2,30



Kartenhalter-Set

card holder set
portatarjetas, set
porte-cartes, set



18-teilig: 6 Kartenhalter 4 x 2,5 cm + 12 Kunststoff-Beschriftungskarten 10 x 6 cm

18 pcs.: 6 card holder 4 x 2,5 cm + 12 plastic cards of inscription 10 x 6 cm

set de 18: 6 soportes 4 x 2,5 cm + 12 tarjetas de plástico 10 x 6 cm

set de 18: 6 supports 4 x 2,5 cm + 12 étiquettes en plastique 10 x 6 cm

	cm	€ / set
00022	4 x 2,5	13,30



Kartenhalter „WÜRFEL“, 4er Set

table stands, 4 pcs.
soporte de mesa, set de 4
porte-étiquettes, set de 4



inklusive 20 weiÙe Beschriftungskarten ca. 10 x 8 cm, mehrfach beschriftbar

including 20 white lables 10 x 8 cm, multiple inscribable

incluye 20 etiquetas blancas 10 x 8 cm, inscribible múltiple

20 étiquettes blanches incluses 10 x 8 cm, inscriptible multiple

	cm		pcs.	€ / set
00078	3 x 3 x 3		4	11,00



Kartenhalter-Set, 4er Set

table stands, 4 pcs.
portatarjetas, set de 4
porte-cartes, set de 4



inklusive 30 Beschriftungskarten (15 x weiÙ + 15 x schwarz)

including 30 labels (15 x white + 15 x black)

incluye 30 tarjetas (15 x blanco + 15 x negro)

includ 20 étiquettes (15 x blanc + 15 x noir)

	cm	↑ cm	pcs.	€ / set
71492	3 x 3	3	4	8,90
71493	3 x 3	3	4	8,90
71494	3 x 3	12	4	9,70



Kartenhalter, 4er Set

table stands, 4 pcs.
soportes de mesa, set de 4
upport de table, set de 4



inklusive 20 weiÙe Beschriftungskarten ca. 10 x 8 cm

including 20 white labels 10 x 8 cm

incluye 20 etiquetas blancas 10 x 8 cm

20 étiquettes blanches incluses 10 x 8 cm

	cm	↑ cm	pcs.	€ / set
00074	3 x 3	12	4	9,70



Kartenhalter, 4er Set

table stands, 4 pcs.
soportes de mesa, set de 4
support de table, set de 4



Rubberwood, inklusive 20 weiÙe Beschriftungskarten ca. 9 x 5,5 cm

rubber wood, including 20 white labels 9 x 5,5 cm

madera de goma, incluye 20 etiquetas blancas 9 x 5,5 cm

bois d'hévéa, 20 étiquettes blanches incluses 9 x 5,5 cm

	cm	↑ cm	pcs.	€ / set
00700	2,5 x 2,5	12	4	8,80

MENU HOLDERS

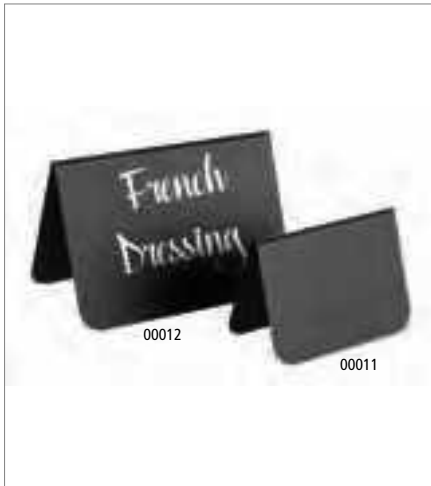

Tischaufsteller, 10er Set

table stands, 10 pcs.
caballes de mesa, set de 10
chevalets de table, set de 10



Ecken abgerundet

corners rounded
esquinas redondeadas
coins arrondies

	cm	↑ cm	pcs.	€/ set
00011	7,5 x 3,5	5	10	8,00
00012	10,5 x 6	6,5	10	9,00



Kartenhalter, 2er Set

card holder, 2 pcs.
soporte de mesa, set de 2
support de table, set de 2



inklusive 40 Beschriftungskarten, durch Magnete einfach zusammenklappbar

including 40 cards, easily foldable with magnets
incluye 40 tarjetas, fácil de plegar, con imanes
inclut 40 étiquettes, fácil à plier, avec aimants

	cm	↑ cm	pcs.	€/ set
00076	9 x 3	5,5	2	19,00



Kartenhalter, 2er Set

menu holder, 2 pcs.
porta cartas de mesa, set de 2
supports pour menu de table, set de 2



Rubberwood / rubber wood / madera de goma / bois d'hévéa

	cm	↑ cm	pcs.	€/ set
00023	8,5 x 6	4,5 / 8,5	2	8,30



Kartenhalter, 2er Set

menu holder, 2 pcs.
porta cartas de mesa, set de 2
porte-menus de table, set de 2



matt poliert
matt polished
pulido mate
poli mat

	cm	↑ cm	pcs.	€/ set
00021	8,5 x 4	4 / 8,5	2	9,70



Bankettkartenständer

menu stand / table number
 porta-etiqueta o carta de sobremesa
 porte-étiquette de table, porte-menu, ou n° de table

hochglanzpoliert

mirror polished
 pulido brillante
 poli brillant



	Ø cm	↑ cm	€
71460	7,5	18,5	8,90
71461	7,5	29	11,50



Kartenhalter, 4er Set

table stands, 4 pcs.
 portatarjetas, set de 4
 porte-cartes, set de 4

hochglanzpoliert, inklusive 20 schwarze Beschriftungskarten aus Polypropylen

mirror polished, including 20 black cards made of polypropylene
 pulido brillante, incluye 20 tarjetas negras de polipropileno
 poli miroir, inclut 20 étiquettes noires en polypropylène



	Ø cm	↑ cm	pcs.	Farbe / Colour	€/ set
71510	5	10,5	4	stainless steel	20,90
71513	5	15,5	4	stainless steel	22,10
71516	5	20,5	4	stainless steel	24,10

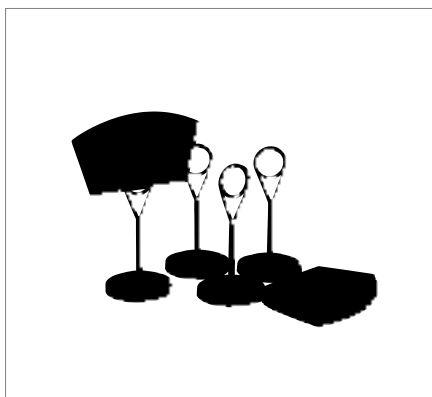

Kartenhalter, 4er Set

table stands, 4 pcs.
 portatarjetas, set de 4
 porte-cartes, set de 4

hochglanzpoliert, inklusive 20 schwarze Beschriftungskarten aus Polypropylen

mirror polished, including 20 black cards made of polypropylene
 pulido brillante, incluye 20 tarjetas negras de polipropileno
 poli miroir, inclut 20 étiquettes noires en polypropylène



	Ø cm	↑ cm	pcs.	Farbe / Colour	€/ set
71512	5	10,5	4	gunmetal	24,10



Tischkartenhalter, 4er Set

table stands, 4 pcs.
 pinzas porta-etiquetas, set de 4
 porte-étiquettes à pince, set de 4

hochglanzpoliert, schwerer Fuß, inklusive 20 weiße Beschriftungskarten

mirror polished, heavy foot, including 20 white labels
 pulido brillante, incluye 20 etiquetas en blanco
 poli brillant, inclut 20 étiquettes blanches



	Ø cm	↑ cm	pcs.	€/ set
00070	4	10	4	23,00

MENU HOLDERS



Schilderhalter „FLEXIBEL“

sign holder
soporte para cartelito
support pour menu de table



biegsamer Draht mit zwei Klemmen, extrem flexibel, die Klemmen lassen sich weit öffnen

bedable metal coil adds visual interest, two metal clip open
metal cromado flexible, 2 pinzas con gran apertura
métal chromé, flexible, 2 pinces à grande ouverture

	→ cm		€
71470	12	ohne Schilder / without signs sin cartelitos / sans étiquette	3,70
71471	23	ohne Schilder / without signs sin cartelitos / sans étiquette	4,40

Schilder, 10er Set / signs, 10 pcs. / set de 10 cartelitos / set de 10 étiquettes

	cm	€ / set
11879	7,7 x 5,2	5,20



Tischaufsteller 2er Set

table stands, 2 pcs.
caballetes de mesa, set de 2
chevalets de table, set de 2



	cm	↑ cm		pcs.	€ / set
00017	5,5 x 5	3,5	reserviert	2	4,20
00013	5,5 x 5	3,5	reserved	2	4,20
00572	5,5 x 5	3,5	no smoking	2	7,20



Kreide-Marker, Stärke 2 mm, 2er Set

chalk marker, 2 pcs.
rotulador de tiza, set de 2
marqueur a la craie liquide, set de 2



Zum Gestalten und Beschriften von Tafeln, Glas und fast allen geschlossenen Oberflächen, deckende Flüssigkreide auf Wasserbasis, feucht abwischbar

For decorating and writing on boards, glass and almost all non-porous surfaces, opaque water-based liquid chalk, wet-wipeable

Rotuladores para pizarra de tiza líquida para decorar y escribir sobre pizarras, cristales y casi todas las superficies no porosas. Tizi líquida opaca al agua que se pueda borrar con un trapo
Pour décorations et inscriptions sur tableaux, verre et presque toutes les surfaces non poreuses, craie liquide opaque à base d'eau, effaçable avec un chiffon humide

	Ø cm	↑ cm	Farbe / Colour	pcs.	€ / set
71490	1	13	white	2	6,20



Beschriftungskarten, 10er Set

designation cards, 10 pcs.
tarjetas, set de 10
étiquettes, set de 10



	cm	* mm	pcs.	€ / set
00037	7,5 x 5	0,4	10	5,20



Windlichter „ELEMENT“, 2er Set

wind lights, 2 pcs.
portavelas antiviento, set de 2
porte-bougies anti-vent, set de 2

möbelschonende Unterseite
furniture-friendly underside
base anti rayaduras
revêtement antirayures



	Ø cm	↑ cm	pcs.	€ / set
03038	6	8	2	13,00

Ersatzglas / spare glass / vidrio de recambio solo / verre de rechange transparent, seul

	Ø cm	↑ cm	€
03098	6	5	2,90



Windlicht „ELEMENT“

wind light
porta vela
porte-bougie

möbelschonende Unterseite
furniture-friendly underside
base anti rayaduras
revêtement antirayures



	Ø cm	↑ cm	€
03039	7,5	13	9,80

Ersatzglas / spare glass / vidrio de recambio solo / verre de rechange transparent, seul

	Ø cm	↑ cm	€
03099	7,5	9	3,60



Vase mit Glaseinsatz „ELEMENT“

flower vase with glass insert
florero con tubo de cristal
vase soliflor avec verre

möbelschonende Unterseite, inklusive 2 Ersatzgläsern
furniture-friendly underside, inclusive 2 spare glasses
base anti rayaduras, incl. 2 tubos de repuesto
revêtement antirayures y compris 2 verres de rechange



	cm	↑ cm	ml	€
04010	10 x 4,5	12,5	25	7,30

Ersatzglas / spare glass / tubo de recambio / verre de rechange

	Ø cm	↑ cm	ml	€
04011	2,5	11	25	1,40



Vase

flower vase
florero
vase soliflor



	Ø cm	↑ cm	€
04015	4	16,5	15,00

UTENSILO



Besteckbehälter / Korb „UTENSILO“

cutlery bin / basket
porta cubiertos / cesta
range-couverts / corbeille



matt poliert, Boden: 29 x 8,5 cm, mit Kunststoffeinsatz
matt polished, base: 29 x 8,5 cm, with plastic insert
pulido mate, base: 29 x 8,5 cm, con inserto de plástico
poli mat, fond: 29 x 8,5 cm, avec insert en plastique

	cm	↑ cm	ltr.	Farbe / Colour	€
11752	29,5 x 12	10	2		11,50



Besteckbehälter / Korb „UTENSILO“

cutlery bin / basket
porta cubiertos / cesta
range-couverts / corbeille



Boden: 29 x 8,5 cm, mit Kunststoffeinsatz
base: 29 x 8,5 cm, with plastic insert
base: 29 x 8,5 cm, con inserto de plástico
fond: 29 x 8,5 cm, avec insert en plastique

	cm	↑ cm	ltr.	Farbe / Colour	€
11753	29,5 x 12	10	2		13,00



Besteckbehälter / Korb „UTENSILO“

cutlery bin / basket
porta cubiertos / cesta
range-couverts / corbeille



Boden: 29 x 8,5 cm, mit Kunststoffeinsatz
base: 29 x 8,5 cm, with plastic insert
base: 29 x 8,5 cm, con inserto de plástico
fond: 29 x 8,5 cm, avec insert en plastique

	cm	↑ cm	ltr.	Farbe / Colour	€
11754	29,5 x 12	10	2		13,00

NEW

**Besteckbehälter „TERRAZZO“**

cutlery bin
recipiente para cubiertos
récipients pour couverts



Terrazzooptik, mit Abflussloch, Bodeneinlagen aus Silikon zum Schonen des Bestecks, möbelschonende Unterseite

terrazzo look, with drain hole, silicone floor inserts for saving the points of knives, furniture-friendly bottom

aspecto terrazzo, con orificio de drenaje, soporte de silicona para proteger las puntas de los cuchillos, con base anti rayaduras
optique terrazzo, avec le trou de drainage, insert de silicone pour protéger les pointes des couteaux, avec revêtement antirayures

	Ø cm	↑ cm	€
11760	11	13,5	17,00

**Besteckbehälter „ELEMENT“**

cutlery bin
porta cubiertos
range-couverts



möbelschonende Unterseite, 3 Fächer, Bodeneinlagen aus Silikon, zum Schonen der Messerspitzen

furniture-friendly underside, 3 compartments, silicone insert to protect the knife tips

con base anti rayaduras, 3 compartimentos, inserto de silicona para proteger los cuchillos

avec revêtement antirayures, 3 compartiments, insert en silicone pour protéger les couteaux

	cm	↑ cm	€
11750	13 x 13	14,5	18,00

**Besteckbehälter „ELEMENT“**

cutlery bin
recipiente para cubiertos
récipients pour couverts



mit Abflussloch, mit Besteck Logo, Bodeneinlagen aus Silikon zum Schonen des Bestecks, möbelschonende Unterseite

with drain hole, with cutlery logo, silicone floor inserts for saving the points of knives, furniture-friendly underside

con orificio de drenaje, con logotipo de cubertería, soporte de silicona para proteger las puntas de los cuchillos, con base antirayaduras

avec le trou de drainage, avec le logo de coutellerie, insert de silicone pour protéger les pointes des couteaux, avec base revêtue antirayures

	Ø cm	↑ cm	€
00018	11	14	17,00

**Besteckbehälter „DART“**

cutlery bin
porta cubiertos
range-couverts



3 Fächer, Bodeneinlagen aus Silikon, zum Schonen der Messerspitzen

3 compartments, silicone insert to protect the knife tips

3 compartimentos, inserto de silicona para proteger los cuchillos

3 compartiments, insert en silicone pour protéger les couteaux

	Ø cm	↑ cm	€
11755	12	25	15,40

CUTLERY BINS



Besteckbehälter, drehbar

cutlery bin, rotatable
porta cubiertos, giratorio
range-couverts, rotatif

innen: mattiert, inklusive herausnehmbarem
Einteiler (3 Fächer), möbelschonende Unterseite

inside: matt finish, including removable, divider (3 compartments),
furniture-friendly underside, Silicone base insert

interior: mate, con separador extraíble
(3 compartimentos), con base anti rayaduras, inserto de silicona

intérieur: mat, avec compartiment amovible
(3 compartiments), base revêtement antirayures, insert en silicone



	Ø cm	↑ cm	Farbe / Colour	€
11747	13	16,5		20,00
11748	13	16,5		20,00



Besteckbehälter

cutlery bin
recipiente para cubiertos
récipients pour couverts

matt poliert
matt polished
pulido mate
poli mat



	Ø cm	↑ cm	€
11921	10	10,0	8,60
11922	12	13,5	11,20



Tischreste-/Besteckbehälter „TOP CHROME“

table waste bin / cutlery bin
papelera de sobremesa / recipiente para cubiertos
poubelle de table / récipients pour couverts

mit verchromten Rand / with chrome plated ring / con anillo cromado / avec bord chromé



	Ø cm	↑ cm	litr.	Farbe / Colour	€
00025	13	15	1		8,00
00026	13	15	1		8,00



Tischreste-/Besteckbehälter „BASE CHROME“

table waste bin / cutlery bin
papelera de sobremesa / recipiente para cubiertos
poubelle de table / récipients pour couverts

mit verchromten Boden / with chrome bottom / con base cromada / avec base chromée



	Ø cm	↑ cm	litr.	Farbe / Colour	€
00019	13	15	1,3		8,00
00020	13	15	1,3		8,00



Besteckkorb „ECONOMIC“
cutlery dispenser
dispensador de cubiertos
corbeille à couverts



	Ø cm	↑ cm	Farbe / Colour	€
40130	12	15		4,80
40007	12	15		4,80
40012	12	15		4,80
40013	12	15		4,80



Besteckkorb „ECONOMIC“
cutlery dispenser
dispensador de cubiertos
corbeille à couverts



	cm	↑ cm	Farbe / Colour	€
40131	27 x 10	4,5		4,80
40009	27 x 10	4,5		4,80
40010	27 x 10	4,5		4,80
40011	27 x 10	4,5		4,80



Table Caddy „COUNTRY STYLE“

table barrel
caddy de mesa
caddy de table



cooler Country-Style, nicht für den direkten Kontakt mit Lebensmittel verwendbar

condiment and cutlery holders or even for food presentation, the mini barrels should not come into contact with food, they should be lined with our greaseproof paper

estilo campestre, no aptos para el contacto directo con alimentos, sólo usando papel alimenticio de style champêtre, pas de contact direct avec aliments, seulement en utilisant papier alimentaire

	Ø cm	↑ cm	€
11930	17,5	8,5	20,00
11931	11,5	14,0	20,00



Tischrestehälter

table garbage bin
papelera de sobremesa
poubelle de table



	Ø cm	↑ cm	ltr.	Farbe / Colour	€
02038	11	14	0,9	White	3,40
02039	11	14	0,9	Black	3,40



Tischrestehälter

table garbage bin
papelera de sobremesa
poubelle de table



Kunststoff weiß / granit, abnehmbarer Schwingdeckel

white plastic, swing cover, cover removable

plástico blanco/granito, tapa basculante desmontable

plastique blanc/gris chiné, couvercle basculant démontable

	Ø cm	↑ cm	ltr.	€
00031	12	18	1,4	6,60



Tischrestehälter „SNAP“

table garbage bin
papelera de sobremesa
poubelle de table



Farbe: whisper white, abnehmbarer Schwingdeckel, mit Bajonettverschluss

colour: whisper white, removable swing cover, with bayonet lock

color: blanco susurro, tapa basculante desmontable, con cierre de bayoneta

couleur: blanc chuchoté, couvercle basculant démontable, avec fermeture à baïonnette

	Ø cm	↑ cm	ltr.	Farbe / Colour	€
40801	12	17	1,2		19,00



Tischrestehälter „SNAP“

table garbage bin
papelera de sobremesa
poubelle de table



Farbe: smoke green, abnehmbarer Schwingdeckel, mit Bajonettverschluss

colour: smoke green, removable swing lid, with bayonet lock

color: smoke green, tapa abatible extraíble, con cierra de bayoneta

couleur: smoke green, couvercle basculant amovible, verrouillage par baïonnette

	Ø cm	↑ cm	ltr.	Farbe / Colour	€
40802	12	17	1,2		19,00

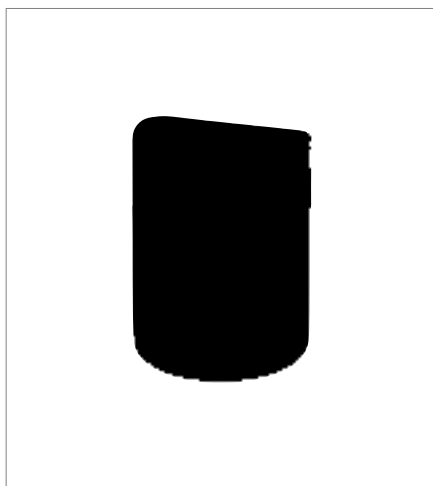

Tischrestehälter „SNAP“

table garbage bin
papelera de sobremesa
poubelle de table



schwarz, abnehmbarer Schwingdeckel, mit Bajonettverschluss

black, removable swing cover, with bayonet lock

negro, tapa basculante desmontable, con cierre de bayoneta

noir, couvercle basculant démontable, avec fermeture à baïonnette

	Ø cm	↑ cm	ltr.	Farbe / Colour	€
40800	12	17	1,2		19,00



00029

Tischrestehälter „SNAP“

table garbage bin
papelera de sobremesa
poubelle de table



matt poliert, abnehmbarer Schwingdeckel, mit Bajonettverschluss

matt polished, swing cover, cover removable, with bayonet lock

pulido mate, tapa basculante desmontable, con cierre de bayoneta

poli mat, couvercle basculant démontable, avec fermeture à baïonnette

	Ø cm	↑ cm	ltr.	Farbe / Colour	€
00029	12	17	1,2		19,00
00027	10	13	0,7		13,90

NEW

CONE



✓
inklusive Ladestation
charging station included

✓
USB Ladekabel
USB charging cable

✓
Fernbedienung inkl. Batterie
remote control incl. battery

✓
möbelschonende Unterseite
furniture-friendly underside



17110
whisper white



17111
black



17112
gold

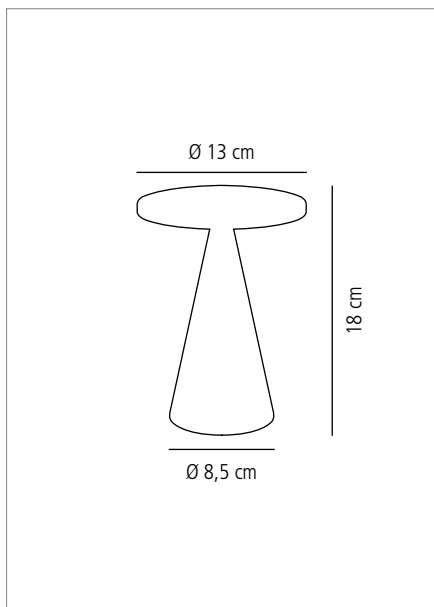

Tischleuchte
table lamp
lámpara de mesa
lampe de table



inklusive Ladestation, USB Ladekabel (ohne Netzteil), Fernbedienung inklusive Batterie
charging station included, USB charging cable (without mains adapter), remote control including battery
con estación de carga, cable de carga USB (sin adaptador de red), mando a distancia inclusivo batería
avec station de charge, câble de charge USB (sans bloc d'alimentation), télécommande avec batterie

	Ø cm	↑ cm	Farbe / Colour	€
17110	13	18	whisper white	76,00
17111	13	18	black	76,00
17112	13	18	gold	80,00

NEW

CONE MINI



✓
inklusive Ladestation
charging station included

✓
USB Ladekabel
USB charging cable

✓
Fernbedienung inkl. Batterie
remote control incl. battery

✓
möbelschonende Unterseite
furniture-friendly underside



17100
whisper white



17101
black



17102
gold

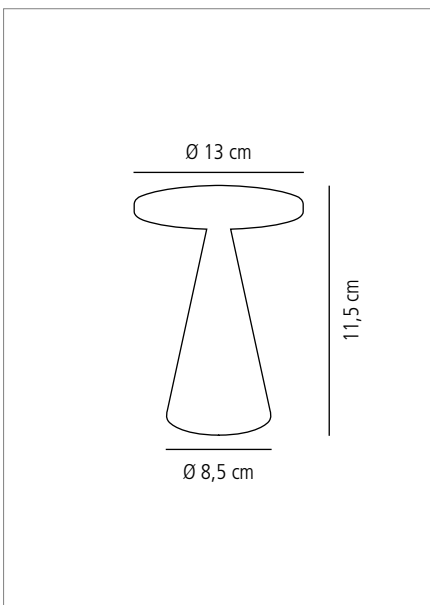

Tischleuchte
table lamp
lámpara de mesa
lampe de table

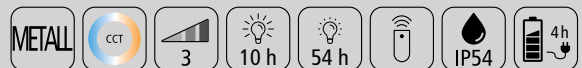

inklusive Ladestation, USB Ladekabel (ohne Netzteil), Fernbedienung inklusive Batterie
charging station included, USB charging cable (without mains adapter), remote control including battery
con estación de carga, cable de carga USB (sin adaptador de red), mando a distancia inclusivo batería
avec station de charge, câble de charge USB (sans bloc d'alimentation), télécommande avec batterie

	Ø cm	↑ cm	Farbe / Colour	€
17100	13	11,5	whisper white	66,00
17101	13	11,5	black	66,00
17102	13	11,5	gold	70,00

NEW JOSEF



✓
inklusive Ladestation
charging station included

✓
USB Ladekabel
USB charging cable

✓
Fernbedienung inkl. Batterie
remote control incl. battery

✓
möbelschonende Unterseite
furniture-friendly underside



17052
champagne

17053
gunmetal

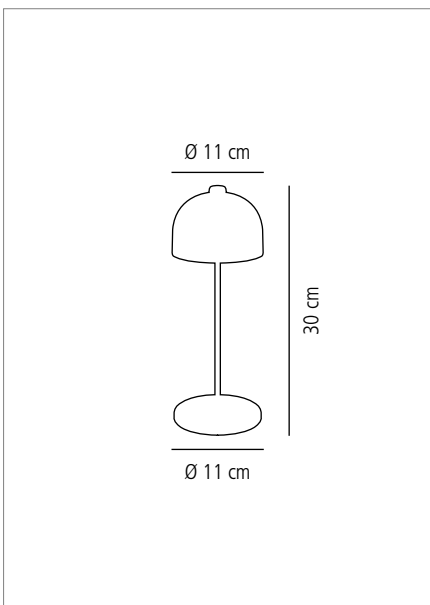

Tischleuchte
table lamp
lámpara de mesa
lampe de table



inklusive Ladestation, USB Ladekabel (ohne Netzteil), Fernbedienung inklusive Batterie
charging station included, USB charging cable (without mains adapter), remote control including battery
con estación de carga, cable de carga USB (sin adaptador de red), mando a distancia inclusivo batería
avec station de charge, câble de charge USB (sans bloc d'alimentation), télécommande avec batterie

	Ø cm	↑ cm	Farbe / Colour	€
17052	11	30	champagne	100,00
17053	11	30	gunmetal	100,00

NEW

JOSEF MINI



✓
inklusive Ladestation
charging station included

✓
USB Ladekabel
USB charging cable

✓
Fernbedienung inkl. Batterie
remote control incl. battery

✓
möbelschonende Unterseite
furniture-friendly underside



17050
champagne

17051
gunmetal

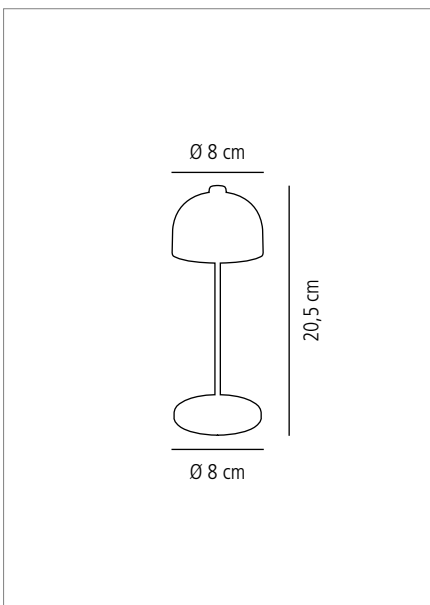

Tischleuchte
table lamp
lámpara de mesa
lampe de table



inklusive Ladestation, USB Ladekabel (ohne Netzteil), Fernbedienung inklusive Batterie
charging station included, USB charging cable (without mains adapter), remote control including battery
con estación de carga, cable de carga USB (sin adaptador de red), mando a distancia inclusivo batería
avec station de charge, câble de charge USB (sans bloc d'alimentation), télécommande avec batterie

	Ø cm	↑ cm	Farbe / Colour	€
17050	8	20,5	 champagne	88,00
17051	8	20,5	 gunmetal	88,00

NEW

NISSRIN



✓
inklusive Ladestation
charging station included

✓
USB Ladekabel
USB charging cable

✓
Fernbedienung inkl. Batterie
remote control incl. battery

✓
möbelschonende Unterseite
furniture-friendly underside



17060
black

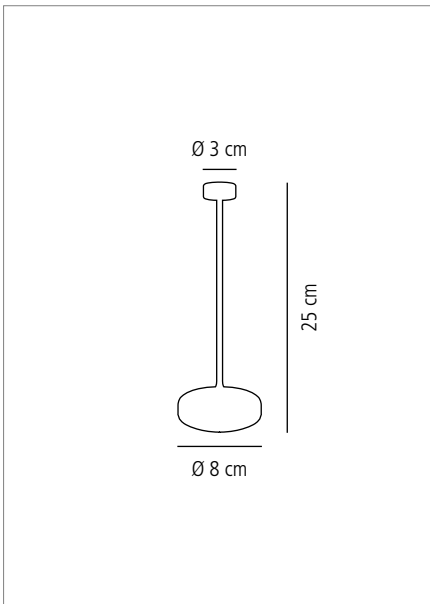

Tischleuchte
table lamp
lámpara de mesa
lampe de table



inklusive Ladestation, USB Ladekabel (ohne Netzteil), Fernbedienung inklusive Batterie
charging station included, USB charging cable (without mains adapter), remote control including battery
con estación de carga, cable de carga USB (sin adaptador de red), mando a distancia inclusivo batería
avec station de charge, câble de charge USB (sans bloc d'alimentation), télécommande avec batterie

	∅ cm	↑ cm	Farbe / Colour	€
17060	8	25	black	60,00

NEW ANTON



✓
inklusive Ladestation
charging station included

✓
USB Ladekabel
USB charging cable

✓
Fernbedienung inkl. Batterie
remote control incl. battery

✓
möbelschonende Unterseite
furniture-friendly underside



17045
mirrored look

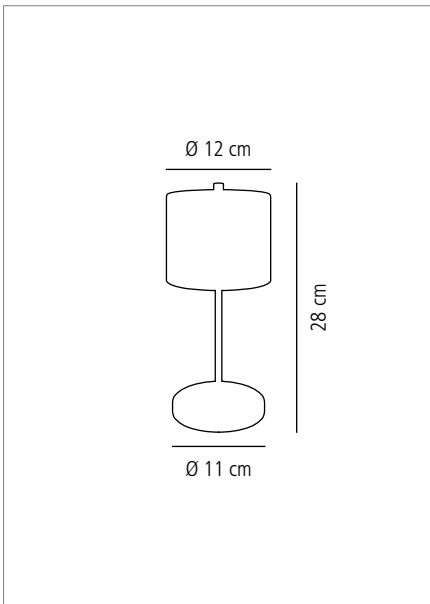

Tischleuchte
table lamp
lámpara de mesa
lampe de table



inklusive Ladestation, USB Ladekabel (ohne Netzteil), Fernbedienung inklusive Batterie
charging station included, USB charging cable (without mains adapter), remote control including battery
con estación de carga, cable de carga USB (sin adaptador de red), mando a distancia inclusivo batería
avec station de charge, câble de charge USB (sans bloc d'alimentation), télécommande avec batterie

	∅ cm	↑ cm	Farbe / Colour	€
17045	12	28	■ ■ ■ mirrored look	74,00

MERLE



✓
inklusive Ladestation
charging station included

✓
USB Ladekabel
USB charging cable

✓
Fernbedienung inkl. Batterie
remote control incl. battery

✓
möbelschonende Unterseite
furniture-friendly underside



17000
whisper white

17009
rust

17002
black

17011
sand



17001
mint

17008
gold

17010
copper

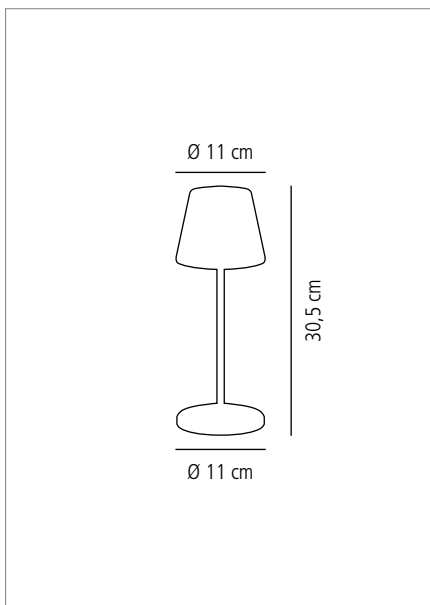

Tischleuchte
table lamp
lámpara de mesa
lampe de table



inklusive Ladestation, USB Ladekabel (ohne Netzteil), Fernbedienung inklusive Batterie
charging station included, USB charging cable (without mains adapter), remote control including battery
con estación de carga, cable de carga USB (sin adaptador de red), mando a distancia inclusivo batería
avec station de charge, câble de charge USB (sans bloc d'alimentation), télécommande avec batterie

	Ø cm	↑ cm	Farbe / Colour	€
17000	11	30,5	whisper white	72,00
17009 <small>NEW</small>	11	30,5	rust	78,00
17002	11	30,5	black	72,00
17011 <small>NEW</small>	11	30,5	sand	72,00
17001	11	30,5	mint	72,00
17008 <small>NEW</small>	11	30,5	gold	78,00
17010 <small>NEW</small>	11	30,5	copper	78,00

NEW

MERLE MINI



✓
inklusive Ladestation
charging station included

✓
USB Ladekabel
USB charging cable

✓
Fernbedienung inkl. Batterie
remote control incl. battery

✓
möbelschonende Unterseite
furniture-friendly underside



17025
whisper white

17028
rust

17026
black

17030
sand



17027
gold

17029
copper

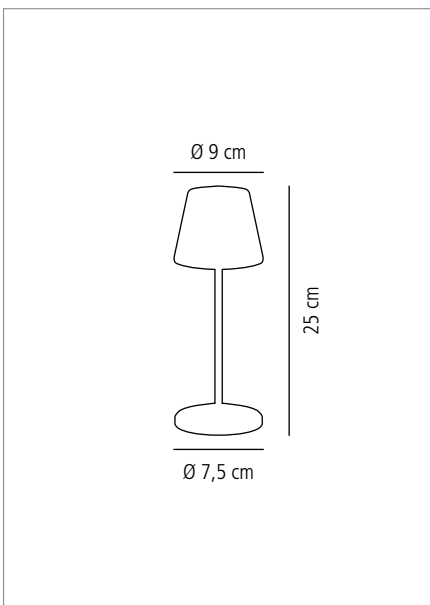

Tischleuchte
table lamp
lámpara de mesa
lampe de table

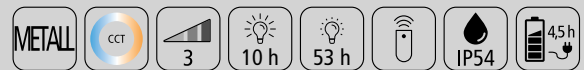

inklusive Ladestation, USB Ladekabel (ohne Netzteil), Fernbedienung inklusive Batterie
charging station included, USB charging cable (without mains adapter), remote control including battery
con estación de carga, cable de carga USB (sin adaptador de red), mando a distancia inclusivo batería
avec station de charge, câble de charge USB (sans bloc d'alimentation), télécommande avec batterie

	Ø cm	↑ cm	Farbe / Colour	€
17025	9	25	whisper white	62,00
17028	9	25	rust	68,00
17026	9	25	black	62,00
17030	9	25	sand	62,00
17027	9	25	gold	68,00
17029	9	25	copper	68,00

NEW

MERLE MICRO



✓
inklusive Ladestation
charging station included

✓
USB Ladekabel
USB charging cable

✓
Fernbedienung inkl. Batterie
remote control incl. battery

✓
möbelschonende Unterseite
furniture-friendly underside



17070
whisper white



17073
rust



17071
black



17075
sand



17072
gold



17074
copper

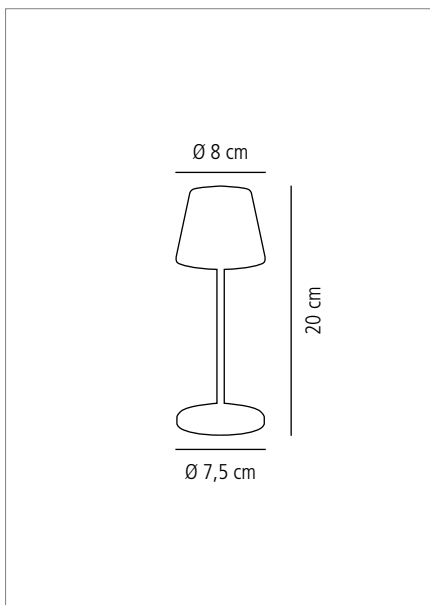

Tischleuchte
table lamp
lámpara de mesa
lampe de table



inklusive Ladestation, USB Ladekabel (ohne Netzteil), Fernbedienung inklusive Batterie
charging station included, USB charging cable (without mains adapter), remote control including battery
con estación de carga, cable de carga USB (sin adaptador de red), mando a distancia inclusivo batería
avec station de charge, câble de charge USB (sans bloc d'alimentation), télécommande avec batterie

	Ø cm	↑ cm	Farbe / Colour	€
17070	8	20	whisper white	59,00
17073	8	20	rust	65,00
17071	8	20	black	59,00
17075	8	20	sand	59,00
17072	8	20	gold	65,00
17074	8	20	copper	65,00

NEW ALVA



✓
inklusive Ladestation
charging station included

✓
USB Ladekabel
USB charging cable

✓
Fernbedienung inkl. Batterie
remote control incl. battery

✓
möbelschonende Unterseite
furniture-friendly underside



17035
whisper white



17038
rust



17036
black



17037
gold



17039
copper

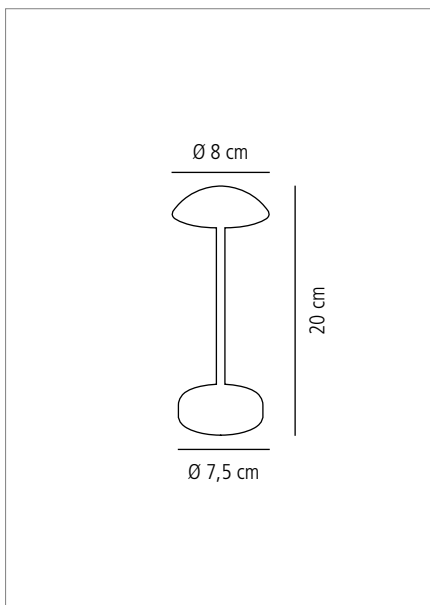

Tischleuchte
table lamp
lámpara de mesa
lampe de table

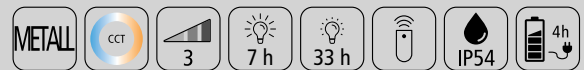

inklusive Ladestation, USB Ladekabel (ohne Netzteil), Fernbedienung inklusive Batterie
charging station included, USB charging cable (without mains adapter), remote control including battery
con estación de carga, cable de carga USB (sin adaptador de red), mando a distancia inclusivo batería
avec station de charge, câble de charge USB (sans bloc d'alimentation), télécommande avec batterie

	Ø cm	↑ cm	Farbe / Colour	€
17035	8	20	whisper white	52,00
17036	8	20	black	52,00
17037	8	20	gold	54,00
17038	8	20	rust	52,00
17039	8	20	copper	54,00

CLEO



- ✓
inklusive Ladestation
charging station included
- ✓
USB Ladekabel
USB charging cable
- ✓
Fernbedienung inkl. Batterie
remote control incl. battery
- ✓
möbelschonende Unterseite
furniture-friendly underside

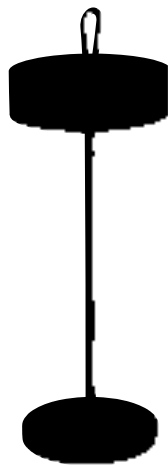

17003
whisper white

17005
black

17004
mint

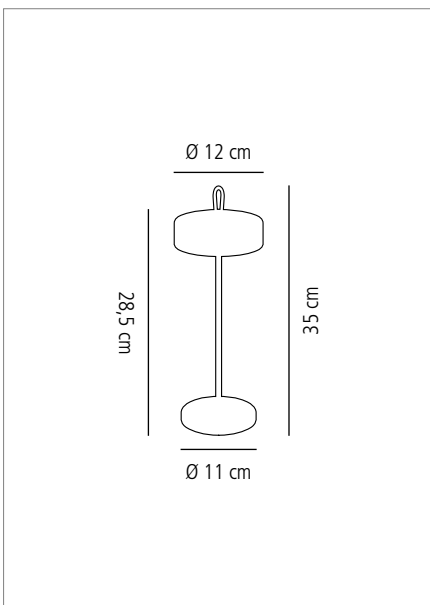

Tischleuchte
table lamp
lámpara de mesa
lampe de table



inklusive Ladestation, USB Ladekabel (ohne Netzteil), Fernbedienung inklusive Batterie
charging station included, USB charging cable (without mains adapter), remote control including battery
con estación de carga, cable de carga USB (sin adaptador de red), mando a distancia inclusivo batería
avec station de charge, câble de charge USB (sans bloc d'alimentation), télécommande avec batterie

	Ø cm	↑ cm	Farbe / Colour	€
17003	12	35	whisper white	74,00
17005	12	35	black	74,00
17004	12	35	mint	74,00

FINN



✓
inklusive Ladestation
charging station included

✓
USB Ladekabel
USB charging cable

✓
Fernbedienung inkl. Batterie
remote control incl. battery

✓
möbelschonende Unterseite
furniture-friendly underside



17006
white

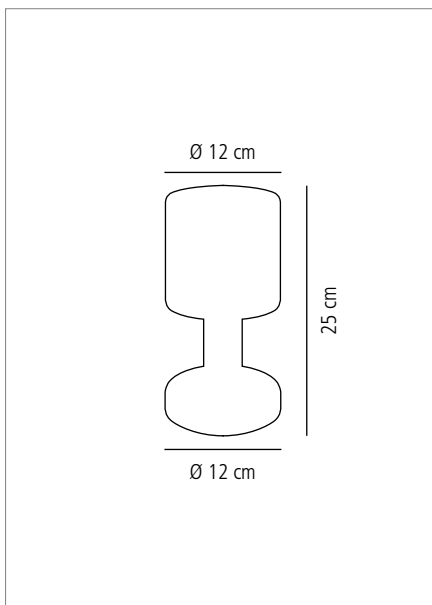

Tischleuchte
table lamp
lámpara de mesa
lampe de table



inklusive Ladestation, USB Ladekabel (ohne Netzteil), Fernbedienung inklusive Batterie
charging station included, USB charging cable (without mains adapter), remote control including battery
con estación de carga, cable de carga USB (sin adaptador de red), mando a distancia inclusivo batería
avec station de charge, câble de charge USB (sans bloc d'alimentation), télécommande avec batterie

	∅ cm	↑ cm	Farbe / Colour	€
17006	12	25	white	49,00

NIELS



✓
inklusive Ladestation
charging station included

✓
USB Ladekabel
USB charging cable

✓
Fernbedienung inkl. Batterie
remote control incl. battery

✓
möbelschonende Unterseite
furniture-friendly underside



17007
white

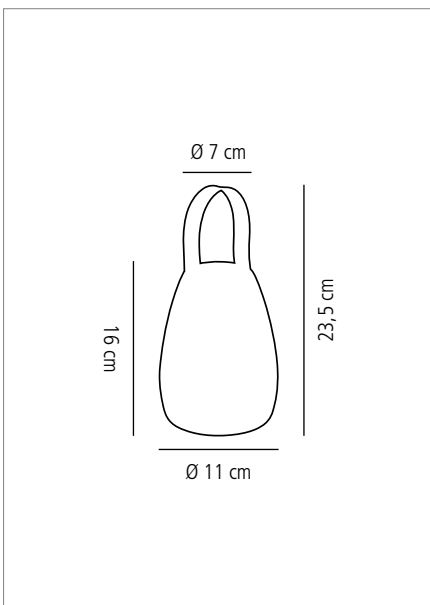

Tischleuchte
table lamp
lámpara de mesa
lampe de table



inklusive Ladestation, USB Ladekabel (ohne Netzteil), Fernbedienung inklusive Batterie
charging station included, USB charging cable (without mains adapter), remote control including battery
con estación de carga, cable de carga USB (sin adaptador de red), mando a distancia inclusivo batería
avec station de charge, câble de charge USB (sans bloc d'alimentation), télécommande avec batterie

	∅ cm	↑ cm	Farbe / Colour	€
17007	11	16	white	36,00

NEW VALUMO



VALUMO – Ihr Buffet, perfekt beleuchtet. Kabellos. Flexibel. Stilvoll.

VALUMO – Your buffet, perfectly illuminated.
Wireless. Flexible. Stylish.

Das Buffet-Beleuchtungssystem VALUMO überzeugt durch seine Kombination aus modernem Design und praktischer Funktionalität. Es besteht aus dem Leuchtkopf Nr. 17090 und vier flexiblen Halterungen. Dank der Magnetkugelfestigung lässt sich der Leuchtkopf nahezu 360 Grad drehen, um das Licht präzise auszurichten.

Die Steuerung erfolgt ganz bequem über eine Fernbedienung oder direkt über den Touch-Button am Gehäuse. Mit Kaltweiß, Warmweiß und RGB-Farben bietet VALUMO vielfältige Beleuchtungsoptionen für jede Stimmung und jeden Anlass.

Der Leuchtkopf wird über die mitgelieferte Ladeplatte oder die optional erhältlichen Mehrfach-Ladeplatten aufgeladen – eine Lösung, die kabellosen Komfort und maximale Flexibilität garantiert.

VALUMO ergänzt das Buffetsystem VALO ideal, ermöglicht eine nahtlose Integration und kann flexibel zusammengestellt werden, um individuellen Anforderungen gerecht zu werden.

The VALUMO buffet lighting system impresses with its combination of modern design and practical functionality. It consists of the light head no. 17090 and four flexible brackets. Thanks to the magnetic ball attachment, the light head can be rotated almost 360 degrees to precisely direct the light.

It can be conveniently controlled via a remote control or directly via the touch button on the housing. With cool white, warm white and RGB colours, VALUMO offers a wide range of lighting options for every mood and occasion.

The light head is charged via the supplied charging plate or the optionally available multiple charging plates - a solution that guarantees wireless convenience and maximum flexibility.

VALUMO is the ideal complement to the VALO buffet system, enables seamless integration and can be flexibly combined to meet individual requirements.



Magnetkugelfestigung
magnetic ball mounting



nahezu 360 Grad drehbar
almost 360 degrees rotatable



Ladestation
charging station



Leuchtkopf
light head
cabezal iluminado
tête lumineuse



inklusive Ladestation, USB Ladekabel (ohne Netzteil), Fernbedienung inklusive Batterie
charging station included, USB charging cable (without mains adapter), remote control including battery
con estación de carga, cable de carga USB (sin adaptador de red), mando a distancia inclusivo batería
avec station de charge, câble de charge USB (sans bloc d'alimentation), télécommande avec batterie

	∅ cm	↑ cm	€
17090	7,5	4,8	28,00



Standfuß inklusive Stab „VALUMO“

stand including rod
soporte con varilla
ped de support, tige incluse

bestehend aus 3 Elementen: Standfuß mit Stab, Erweiterungsstab, Magnetkugel
consisting of 3 elements: stand with rod, extension rod, magnetic sphere
consta de 3 elementos: soporte con varilla, varilla de prolongación, esfera magnética
composé de 3 éléments : pied avec tige, tige de rallonge, boule magnétique



	∅ cm	↑ cm	€
17092	14	31 - 51	19,00

Lieferung ohne Leuchtkopf Nr. 17090
delivery without light head no. 17090

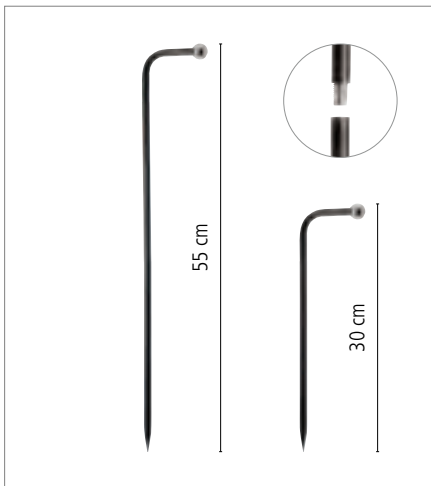

Stab zum Stecken „VALUMO“

stick for insertion
varilla de inserción
tige à enfoncer

bestehend aus 3 Elementen: Spitze (24 cm), Erweiterungsstab, Magnetkugel
consisting of 3 elements: tip (24 cm), extension rod, magnetic sphere
consta de 3 elementos: punta (24 cm), alargadera, esfera magnética
composé de 3 éléments : pointe (24 cm), barre d'extension, boule magnétique



	∅ cm	↑ cm	fits to	€
17093	0,9	30 - 55	14030 VALO	9,00

Lieferung ohne Leuchtkopf Nr. 17090
delivery without light head no. 17090

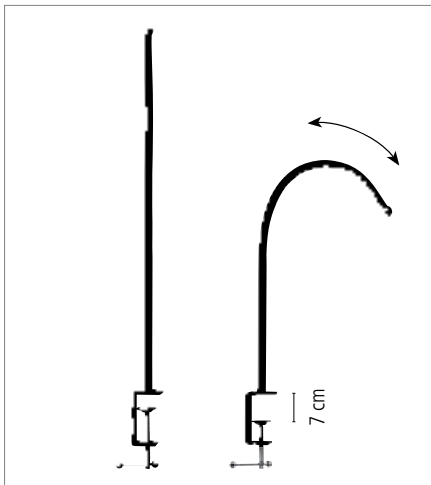

Schraubklammer mit flexiblem Arm „VALUMO“

screw clamp with flexible arm
abrazadera de tornillo con brazo flexible
pince à visser avec bras flexible

zum Befestigen an Buffetelementen oder Tischplatten, mit flexiblem Arm
for attachment to buffet elements or table tops, with flexible arm
para fijar a elementos de buffet o tableros de mesa, con brazo flexible
à fixer sur des éléments de buffet ou des plateaux de table, avec bras flexible



	cm	↑ cm	€
17094	4,5 x 4	64	19,00

Lieferung ohne Leuchtkopf Nr. 17090
delivery without light head no. 17090

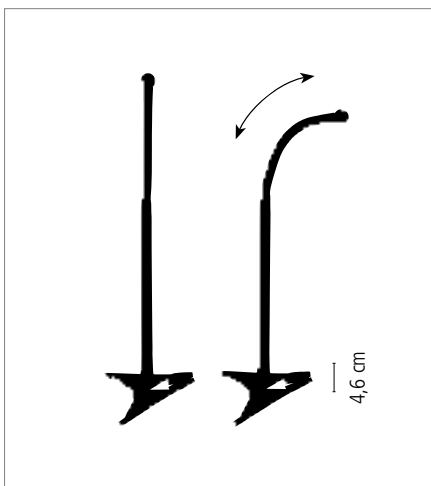

Klammer mit flexiblem Arm „VALUMO“

clamp with flexible arm
pinza con brazo flexible
agrafe avec bras flexible

zum einfachen Befestigen an Buffetelementen oder Tischplatten, mit flexiblem Arm
for easy attachment to buffet elements or table tops, with flexible arm
para fijar fácilmente a elementos de bufé o tableros de mesa, con brazo flexible
pour une fixation facile sur des éléments de buffet ou des plateaux de table, avec bras flexible



	cm	↑ cm	€
17091	11 x 7,5	40	16,00

Lieferung ohne Leuchtkopf Nr. 17090
delivery without light head no. 17090



NEW



fits to table lamps
with max. Ø 9 cm

Ladestation, 12-fach
charging station, 12-fold
estación de carga, 12 vías
sation de charge, 12 places



Kompakt und transportsicher: Die Tischleuchten stehen stabil auf den magnetischen Kontakten der Ladestation. Zwei Ladestationen können mit den Verbindungsrohren no. 17022 übereinander montiert werden, um bis zu 24 Leuchten gleichzeitig mit einem Kabel zu laden.

compact and safe to transport: the table lamps are stable on the magnetic contacts of the charging station. Two charging stations can be mounted on top of each other with the connecting tubes no. 17022 to charge up to 24 lights simultaneously with one cable.

compacta y segura de transportar: las lámparas de mesa se mantienen estables sobre los contactos magnéticos de la estación de carga. Se pueden montar dos estaciones de carga una encima de otra con los tubos de conexión nº 17022 para cargar hasta 24 lámparas simultáneamente con un solo cable.

compact et sûr pour le transport : les lampes de table sont stables sur les contacts magnétiques de la station de charge. Deux stations de charge peuvent être montées l'une sur l'autre à l'aide des tubes de connexion no. 17022 pour charger jusqu'à 24 lampes simultanément avec un seul câble.

	cm	↑ cm	€
17024	43 x 33	4,5	210,00



fits to all table lamps
in the product range

Ladestation, 6-fach
charging station, 6-fold
estación de carga, 6 vías
sation de charge, 6 places



Kompakt und transportsicher: Die Tischleuchten stehen stabil auf den magnetischen Kontakten der Ladestation. Zwei Ladestationen können mit den Verbindungsrohren no. 17022 übereinander montiert werden, um bis zu 12 Leuchten gleichzeitig mit einem Kabel zu laden.

compact and safe to transport: the table lamps are stable on the magnetic contacts of the charging station. Two charging stations can be mounted on top of each other with the connecting tubes no. 17022 to charge up to 12 lights simultaneously with one cable.

compacta y segura de transportar: las lámparas de mesa se mantienen estables sobre los contactos magnéticos de la estación de carga. Se pueden montar dos estaciones de carga una encima de otra con los tubos de conexión nº 17022 para cargar hasta 12 lámparas simultáneamente con un solo cable.

compact et sûr pour le transport : les lampes de table sont stables sur les contacts magnétiques de la station de charge. Deux stations de charge peuvent être montées l'une sur l'autre à l'aide des tubes de connexion no. 17022 pour charger jusqu'à 12 lampes simultanément avec un seul câble.

	cm	↑ cm	fits to	€
17020	43 x 31,5	5	11977, 11944, 11945	138,00



fits to all table lamps
in the product range

Ladestation, 15-fach
charging station, 15-fold
estación de carga, 15 vías
sation de charge, 15 places



	cm	↑ cm	fits to	€
17021	75 x 43	5	11977, 11944, 11945	230,00



Ersatzteilset für Tischleuchten
spare parts set for table lamp
set de repuesto para lámpara
set de pièces de rechange



Set bestehend aus: Ladeplatte, Kabel (USB A auf USB C), Fernbedienung inklusive Batterie

set consisting of: charging plate, cable (USB A auf USB C), remote control incl. battery

set compuesto por: placa de carga, cable (USB A a USB C), mando a distancia incl. batería

set composé de: plaque de chargement, câble (USB A vers USB C), télécommande avec batterie

	Ø cm	↑ cm	€
17023	11	1	7,90

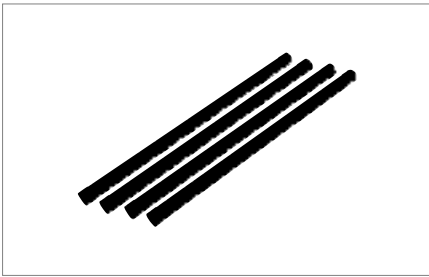

Rohre für Ladestation
 tubes for charging station
 tubos para estación de carga
 tubes pour station de charge



passend zu Ladestation / suitable for charging station / para estación de carga / pour station de charge

	∅ cm	↑ cm	fits to	pcs.	Farbe / Colour	€ / set
17022	2	43	17020, 17021, 17024	4	■	9,00



Servier- / Transportwagen „GO“

service trolley
 carro de servicio
 chariot de service



mit 2 Borden, Bordmaße 83 x 51 cm, Abstand zwischen den Borden 56 cm, Tragfähigkeit 80 kg, 4 Lenkrollen, davon 2 feststellbar, Lieferung demontiert, einfache Montage
 with 2 trays, trays 83 x 51 cm, size between the trays 56 cm, total load capacity 80 kg, 4 wheels with 2 brakes, unassembled, simple assembly

con 2 bandejas de acero inoxidable mate, 83 x 51 cm, la medida entre bandejas 56 cm, capacidad total 80 kg, 4 ruedas, con 2 frenos, construcción robusta, montaje fácil
 2 niveaux, 83 x 51 cm chacun, distance entre niveaux 56 cm, capacité maxi 80 kg au total, 4 roues dont 2 avec frein, construction robuste, montage facile

	cm	↑ cm	€
11977	91 x 59	93	146,00



Servier- / Transportwagen „READY“

service trolley
 carro de servicio
 chariot de service



3 Böden, Abstand zwischen den Böden 31 cm, mit 4 Lenkrollen, alle mit Feststellern, Tragfähigkeit: 50 kg je Boden, 150 kg insgesamt, Lieferung demontiert, einfache Montage
 3 shelves, distance between shelves 31 cm, 4 swivel wheels, all equipped with brakes, max. load per shelf 50 kg, 150 kg total, demounted, easy to mount

3 pisos, distancia entre cada piso 31 cm, 4 ruedas giratorias, todas con freno, capacidad de carga: 50 kg por piso, 150 kg en total, desmontado, montaje sencillo

3 étages, distance entre les niveaux 31 cm, 4 roues pivotantes, toutes avec freins, capacité de charge: 50 kg par niveau, 150 kg au total, livré démonté, montage facile

	cm	↑ cm	Farbe / Colour	€
11944 <small>new</small>	108 x 50	96	■ black	150,00
11945	108 x 50	96	■ blue-grey	150,00







Baskets

BASIC.....	401
BASKETS / RISERS.....	420
BREAD BASKETS.....	404
COVE.....	400
ECONOMIC.....	396
EGG BASKETS.....	403
GN LINE.....	394
PROFI LINE.....	390
SPHERE.....	415
STAINLESS STEEL BASKETS.....	418
SVART.....	408
URBAN.....	412

PROFI LINE



hellbeige / light beige
beis claro / beige clair

beige / beige
beis / beige

braun / brown
marrón / marron

schwarz / black
negro / noir

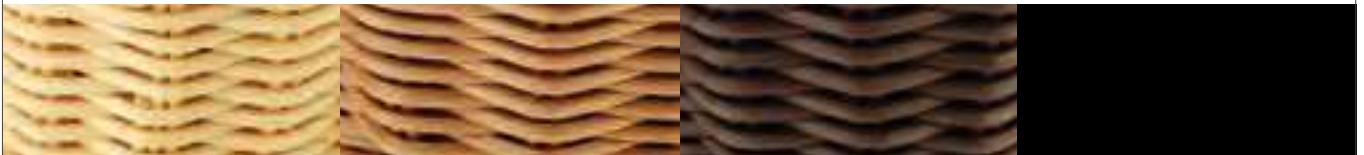

Korb "PROFI LINE"
basket baker size
cesta tamaño panaderia
corbeille dimensions „boul-pâte“



	cm	↑ cm	Farbe / Colour	€
50915	60 x 40	5	hellbeige	40,00
50918	60 x 40	5	schwarz	40,00

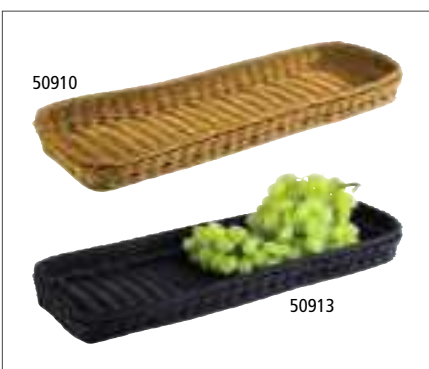

Korb "PROFI LINE"
basket baker size
cesta tamaño panaderia
corbeille dimensions „boul-pâte“



	cm	↑ cm	Farbe / Colour	€
50910	60 x 20	5	hellbeige	27,00
50913	60 x 20	5	schwarz	27,00



Korb "PROFI LINE"
basket baker size
cesta tamaño panaderia
corbeille dimensions „boul-pâte“



	cm	↑ cm	Farbe / Colour	€
50905	40 x 30	5	hellbeige	24,00
50908	40 x 30	5	schwarz	24,00
<hr/>				
	cm	↑ cm	Farbe / Colour	€
50710	40 x 30	10	hellbeige	26,00
50712	40 x 30	10	schwarz	26,00



Systemkorb, gestäbt „PROFI LINE“

basket
cesta
corbeille



	cm	↑ cm	Farbe / Colour	€
50305	45 x 40	27 / 16		80,00



Systemkorb „PROFI LINE“

basket
cesta
corbeille



	cm	↑ cm	Farbe / Colour	€
50400	40 x 50	25 / 14		58,00

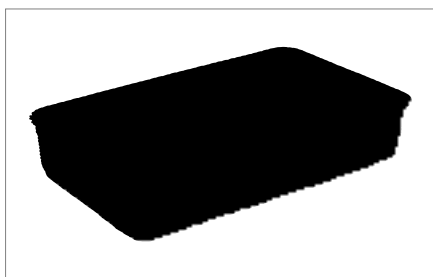

GN 1/1 Korb „PROFI LINE“

GN 1/1 basket
GN 1/1 cesta
GN 1/1 corbeille



	cm	↑ cm	Farbe / Colour	€
50722	53 x 32,5	10		33,00



Korb „PROFI LINE“

basket
cesta
corbeille



	Ø cm	↑ cm	Farbe / Colour	€
50205	31 / 37	12 / 6		26,00



Korb „PROFI LINE“

basket
cesta
corbeille



	Ø cm	↑ cm	Farbe / Colour	€
50210	37	9		20,60



Korb „PROFI LINE“

basket
cesta
corbeille



	cm	↑ cm	Farbe / Colour	€
50702	26,5 x 19	7		11,00

	cm	↑ cm	Farbe / Colour	€
50707	31 x 21	9		12,80

PROFI LINE



Baguette Korb „PROFI LINE“ baguette basket cesta de baguette corbeille à baguettes



	cm	↑ cm	Farbe / Colour	€
50805	28 x 16	8		10,00
50806	28 x 16	8		10,00
50808	28 x 16	8		10,00
50807	28 x 16	8		10,00

	cm	↑ cm	Farbe / Colour	€
50823	40 x 16	8		13,00



Korb „PROFI LINE“ basket cesta corbeille



	cm	↑ cm	Farbe / Colour	€
50800	25 x 19	6,5		8,80
50801	25 x 19	6,5		8,80
50803	25 x 19	6,5		8,80
50802	25 x 19	6,5		8,80

	cm	↑ cm	Farbe / Colour	€
50815	32 x 23	7		11,20
50817	32 x 23	7		11,20



Korb „PROFI LINE“ basket cesta corbeille



	Ø cm	↑ cm	Farbe / Colour	€
50600	16	8		7,40
50601	16	8		7,40
50603	16	8		7,40
50602	16	8		7,40

	Ø cm	↑ cm	Farbe / Colour	€
50605	20	8		10,00
50606	20	8		10,00
50608	20	8		10,00
50607	20	8		10,00

	Ø cm	↑ cm	Farbe / Colour	€
50612	29	7		12,60



Korb „PROFI LINE“ basket cesta corbeille



	cm	↑ cm	Farbe / Colour	€
50631	19 x 13	6		5,20
50630	19 x 13	6		5,20



Korb „PROFI LINE“
basket
cesta
corbeille



	cm	↑ cm	Farbe / Colour	€
50624	19 x 12	6		5,20
50625	19 x 12	6		5,20
50627	19 x 12	6		5,20
50626	19 x 12	6		5,20



Korb „PROFI LINE“
basket
cesta
corbeille



	Ø cm	↑ cm	Farbe / Colour	€
50620	13	10		5,20
50621	13	10		5,20
50623	13	10		5,20
50622	13	10		5,20



Auslage Tablett „PROFI LINE“
display tray
bandeja de presentación
plateau de présentation



	cm	↑ cm	Farbe / Colour	€
40296	40 x 30	1		17,00
40297	60 x 40	1		29,00

GN LINE

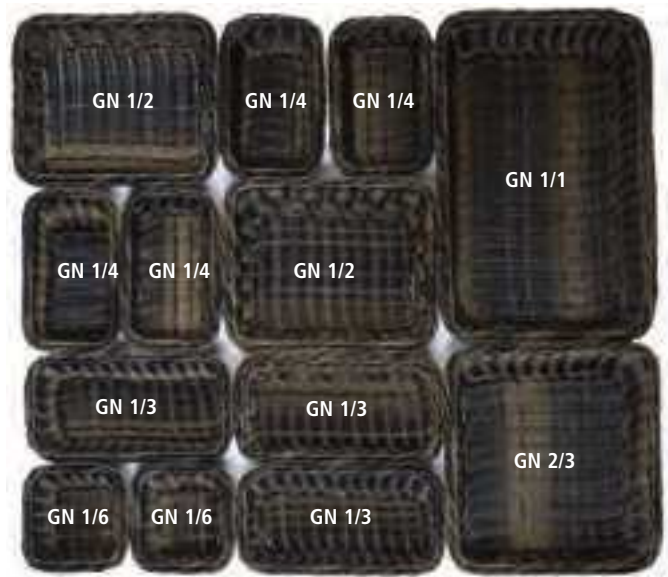

2 Höhen - 6,5 und 10 cm
2 heights - 6,5 and 10 cm



40293
GN 1/1 - 10 cm



40292
GN 1/2 - 10 cm



40225
GN 1/4 - 6,5 cm

Korb „GN LINE“

GN basket

GN cesta

GN corbeille



stabile Ausführung mit Edelstahldraht im Rand zur Stabilisierung

very solid with stainless steel wire frame to stabilize the basket

muy resistente con refuerzo de alambre inox

très résistante avec son fil de renfort inox

	cm	↑ cm	GN	Farbe / Colour	€
40291	53,0 x 32,5	6,5	1/1		26,00
40290	32,5 x 26,5	6,5	1/2		15,80
40223	32,5 x 17,6	6,5	1/3		12,60
40225	26,5 x 16,2	6,5	1/4		9,60
40227	17,6 x 16,2	6,5	1/6		6,50
40229	32,5 x 35,4	6,5	2/3		18,80
	cm	↑ cm	GN	Farbe / Colour	€
40293	53,0 x 32,5	10	1/1		31,40
40292	32,5 x 26,5	10	1/2		18,80
40243	32,5 x 17,6	10	1/3		14,80
40245	26,5 x 16,2	10	1/4		11,40
40247	17,6 x 16,2	10	1/6		9,60
40249	32,5 x 35,4	10	2/3		23,00

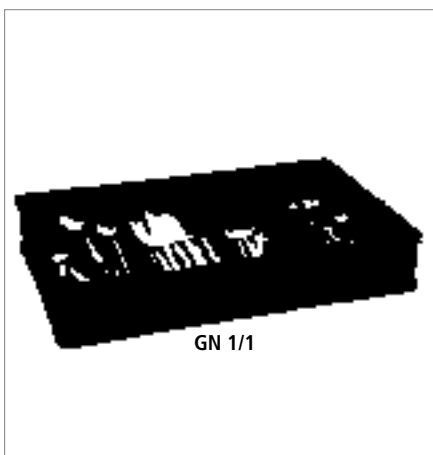

GN 1/1 Besteckbehälter

GN 1/1 dispenser GN

GN 1/1 dispensador de cubiertos

GN 1/1 bac à couverts



4 Mulden, Kunststoff-Geflecht, Drahtgestell, braun-schwarz

4 compartments, with reinforced chromed wire structure, brown-black

4 compartimentos, de plástico, con bastidor cromado reforzado, marrón oscuro

4 compartiments, en plastique, cadre acier chromé renforcé, couleur marron foncé

	cm	↑ cm	GN	Farbe / Colour	€
11966	53 x 32,5	9	1/1		43,00

GN LINE

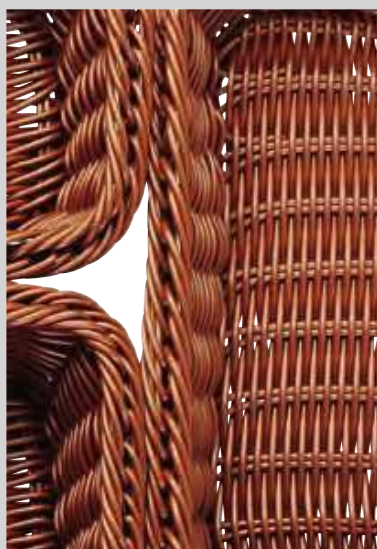

2 Höhen - 6,5 und 10 cm
2 heights - 6,5 and 10 cm



40220 GN 1/1



40222 GN 1/2



40228 GN 1/6



40264 GN 1/4

40272 GN 1/2

Korb „GN LINE“

GN basket
GN cesta
GN corbeille



stabile Ausführung mit Edelstahldraht im Rand zur Stabilisierung

very solid with stainless steel wire frame to stabilize the basket

muy resistente con refuerzo de alambre inox

très résistante avec son fil de renfort inox

	cm	↑ cm	GN	Farbe / Colour	€
40220	53,0 x 32,5	6,5	1/1		23,00
40222	32,5 x 26,5	6,5	1/2		13,90
40224	32,5 x 17,6	6,5	1/3		11,80
40226	26,5 x 16,2	6,5	1/4		8,80
40228	17,6 x 16,2	6,5	1/6		6,20
40230	32,5 x 35,4	6,5	2/3		18,20
	cm	↑ cm	GN	Farbe / Colour	€
40240	53,0 x 32,5	10	1/1		30,00
40242	32,5 x 26,5	10	1/2		18,40
40244	32,5 x 17,6	10	1/3		13,90
40246	26,5 x 16,2	10	1/4		10,00
	cm	↑ cm	GN	Farbe / Colour	€
40260	53,0 x 32,5	6,5	1/1		23,00
40262	32,5 x 26,5	6,5	1/2		13,90
40263	32,5 x 17,6	6,5	1/3		11,40
40264	26,5 x 16,2	6,5	1/4		8,80
	cm	↑ cm	GN	Farbe / Colour	€
40270	53,0 x 32,5	10	1/1		30,00
40272	32,5 x 26,5	10	1/2		18,40
40274	32,5 x 17,6	10	1/3		13,90
40276	26,5 x 16,2	10	1/4		9,90



Tisch- und Buffetkorb „ECONOMIC“

buffet basket
cesta de buffet
corbeille de buffet



	Ø cm	↑ cm	Farbe / Colour	€
40132	19,0	9,5		5,40
40135	25,5	8,5		7,40
40144	39,0	10,0		19,00
40191	19,0	9,5		5,40
40192	25,5	8,5		7,40



Tisch- und Buffetkorb „ECONOMIC“

buffet basket
cesta de buffet
corbeille de buffet



	cm	↑ cm	Farbe / Colour	€
40137	23,0 x 17	8,0		5,90
40139	28,5 x 17	8,5		7,60
40193	23,0 x 17	8,0		5,90
40194	28,5 x 17	8,5		7,60



stapelbar
stackable



Tisch- und Buffetkorb „ECONOMIC“

buffet basket
cesta de buffet
corbeille de buffet



	cm	↑ cm	Farbe / Colour	€
40140	23,0 x 17	8		5,90
40159	31,5 x 22	8,5		8,80
40195	23,0 x 17	8		5,90
40196	31,5 x 22	8,5		8,80



GN Buffetkorb „ECONOMIC“

GN basket
GN cesta
GN corbeille



	cm	↑ cm	GN	Farbe / Colour	€
40148	53,0 x 32,5	8	1/1		33,00
40152	32,5 x 26,5	8	1/2		13,20

**Buffetkorb „ECONOMIC“**

buffet basket
cesta de buffet
corbeille de buffet



stabile Ausführung mit Edelstahldraht im Rand zur Stabilisierung

very solid with stainless steel wire frame to stabilize the basket

muy resistente con refuerzo de alambre inox

très résistante avec son fil de renfort inox

	cm	↑ cm	€
40153	45 x 42	17 / 24	34,90



40149

Buffetkorb, rund „ECONOMIC“

buffet basket, round
cesta de buffet, redonda
corbeille de buffet ronde



stabile Ausführung mit Edelstahldraht im Rand zur Stabilisierung

very solid with stainless steel wire frame to stabilize the basket

muy resistente con refuerzo de alambre inox

très résistante avec son fil de renfort inox

	Ø cm	↑ cm	Farbe / Colour	€
40149	40	12,5		25,20
40295	40	12,5		23,00



18389

Rolltophaube mit verchromtem Kugelgriff / rolltop cover with chrome plated handle / campana abatible con pomo cromado / cloche basculante avec bouton chromé

	Ø cm	↑ cm	€
18388	38	20	24,00

Rolltophaube mit vergoldetem Kugelgriff / rolltop cover with gold plated handle / campana abatible con pomo dorado / cloche basculante avec bouton doré

	Ø cm	↑ cm	€
18387	38	20	24,00

Rolltophaube mit verchromtem Designergriff / rolltop cover with chrome plated designer handle / campana abatible con pomo de diseño cromado / cloche basculante avec bouton design chromé

	Ø cm	↑ cm	€
18389	38	20	23,00



11010

Buffetkorb „ECONOMIC“

buffet basket
cesta de buffet
corbeille buffet



stabile Ausführung, Edelstahl Fixierungsrahmen, zur Rutschsicherung, ohne Haube

stainless steel fix the cover, without cover

con marco cromado patentado para fijar y encajar la campana (se entrega sin la campana)

cadre fil acier inoxydable pour fixer la cloche (livré sans la cloche)

	cm	↑ cm	Farbe / Colour	€
40150	56,5 x 36	10		40,00
40294	56,5 x 36	10		33,00

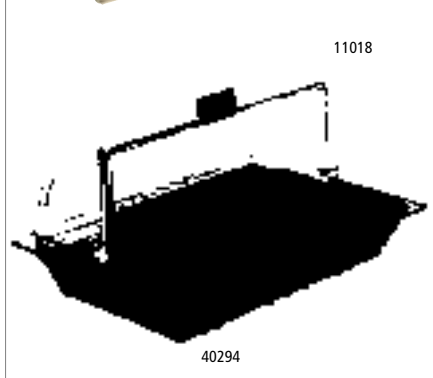

11018

GN 1/1 Rolltop-Haube / GN 1/1 rolltop cover / GN 1/1 campana abatible / GN 1/1 cloche basculante

	cm	↑ cm	GN	€	
11010	53 x 32,5	19	1/1	verchromter Griff / chrome plated handle pomo cromado / bouton chromé	64,00
11018	53 x 32,5	17	1/1	mit verchromtem Designergriff with chrome plated designer handle	64,00

ECONOMIC



Buffetgestell „DOPPELDECKER“ für GN

buffet frame for GN
estructura para buffet para GN
support buffet pour GN



2-teilig, einfach zusammensetzbar, Etagen-Abstand 26 cm, platzsparend, stabile Ausführung

2 pcs., easy to assemble, distance between the tiers 26 cm, space-saving, robust

2 pzas, fácil de montar, distancia entre pisos 26 cm, robusto

2 pcs, assemblage facile, distance entre niveaux 26 cm, robuste

	cm	↑ cm	fits to GN	€
11555	50 x 34	37,5	1/1	90,00



GN Kuppelhaube

GN cover
GN cúpula
GN cloche bombée



glasklarer Kunststoff, Griff aus Zinkdruckguss

crystal clear plastic, die-cast zinc knob

plástico transparente, asa de zinc fundido a presión

plastique transparente, poignée en zinc moulé sous pression

	cm	↑ cm	GN		€
11026	54 x 33	20	1/1	geschlossen / totally closed cerrada / totalmente fermée	52,00
11027	54 x 33	20	1/1	mit Front-Ausschnitt / one long side cut out gran apertura frontal / grande ouverture frontale	54,00
11028	54 x 33	20	1/1	mit seitlichem Ausschnitt / one small side cut out / pequeña apertura lateral / petite ouverture latérale	54,00



GN Kuppelhaube

GN cover
GN cúpula
GN cloche bombée



glasklarer Kunststoff, Griff aus Zinkdruckguss

crystal clear plastic, die-cast zinc knob

plástico transparente, asa de zinc fundido a presión

plastique transparente, poignée en zinc moulé sous pression

	cm	↑ cm	GN		€
11070	54 x 33	20	1/1	geschlossen / totally closed cerrada / totalmente fermée	52,00
11071	54 x 33	20	1/1	mit Front-Ausschnitt / one long side cut out gran apertura frontal / grande ouverture frontale	54,00
11072	54 x 33	20	1/1	mit seitlichem Ausschnitt / one small side cut out / pequeña apertura lateral / petite ouverture latérale	54,00



Baguettekorb „ECONOMIC“

baguette basket
cesta para baguette
corbeille pour baguettes



stabile Ausführung mit Edelstahl draht im Rand zur Stabilisierung

very solid with stainless steel wire frame to stabilize the basket

muy resistente con refuerzo de alambre inox

très résistante avec son fil de renfort inox

	Ø cm	↑ cm	Farbe / Colour	€
40198	35	24 / 42		57,00



Besteckkorb „ECONOMIC“

cutlery dispenser
dispensador de cubiertos
corbeille à couverts



4 Fächer (3 kleine und 1 großes) / 4 compartments (3 small and 1 large) /
4 compartimentos (3 pequeños y 1 grande) / 4 compartiments (3 petits et 1 grand)

	cm	↑ cm	Farbe / Colour	€
40179	26 x 18	15	Yellow	17,60
40182	26 x 18	15	Black	17,60



Besteckkorb „ECONOMIC“

cutlery dispenser
dispensador de cubiertos
corbeille à couverts



	Ø cm	↑ cm	Farbe / Colour	€
40130	12	15	Yellow	4,80
40007	12	15	Black	4,80
40012	12	15	Brown	4,80
40013	12	15	Grey	4,80

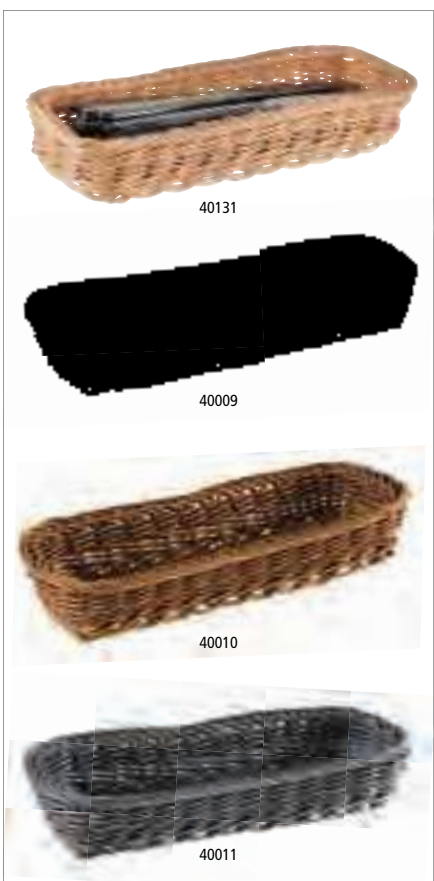

Besteckkorb „ECONOMIC“

cutlery dispenser
dispensador de cubiertos
corbeille à couverts



	cm	↑ cm	Farbe / Colour	€
40131	27 x 10	4,5	Yellow	4,80
40009	27 x 10	4,5	Black	4,80
40010	27 x 10	4,5	Brown	4,80
40011	27 x 10	4,5	Grey	4,80

NEW

COVE



Korb „COVE“

basket
cesta
corbeille



mit Edelstahlraht im Rand und Boden zur Stabilisierung
with stainless steel wire in the rim and base for stabilisation
con alambre de acero inoxidable en el borde y la base para su estabilización
avec fil d'acier inoxydable dans le bord et le fond pour la stabilisation

	cm	↑ cm	Farbe / Colour	€
40340	Ø 20 cm	7	beige	5,90
40341	Ø 20 cm	7	brown	5,90
40342	28 x 16	4	beige	5,90
40343	28 x 16	4	brown	5,90
40344	30 x 15	5	beige	5,60
40345	30 x 15	5	brown	5,60

BASIC

**Brot- und Obstkorb „BASIC“**

basket for bread or fruits
cesta para pan o fruta
corbeille à pain ou à fruits



	cm	↑ cm	€
30279	18 x 12	7	3,20
30280	23 x 15	6	3,40

**Brot- und Obstkorb „BASIC“**

basket for bread or fruits
cesta para pan o fruta
corbeille à pain ou à fruits

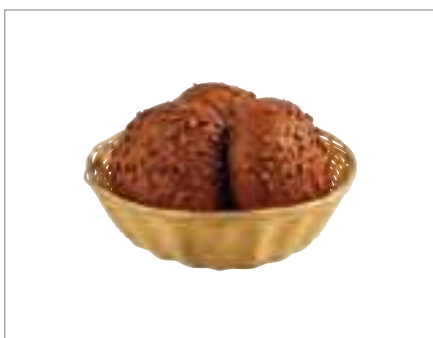

	cm	↑ cm	€
30282	21 x 10	6	3,00

**Brot- und Obstkorb „BASIC“**

basket for bread or fruits
cesta para pan o fruta
corbeille à pain ou à fruits



	Ø cm	↑ cm	€
30281	20	7	3,40
30285	25	7	4,70

**Tisch- und Buffetkorb „BASIC“**

buffet basket
cesta de buffet
corbeille de buffet



	cm	↑ cm	€
30286	30 x 22	7	4,60
30283	22 x 15	6	3,70



Brot- und Obstkorb „WICKER LOOK“

basket for bread or fruits
cesta para pan o fruta
corbeille à pain ou à fruits



	cm	↑ cm	Farbe / Colour	€
40214	Ø 20	6,5	■	3,20
40216	23 x 17	6,5	■	3,50
	cm	↑ cm	Farbe / Colour	€
40212	39,5 x 29,5	10	■	10,00



GN 1/1 Korb „SUPERSTRONG“

GN 1/1 basket
GN 1/1 cesta
GN 1/1 corbeille



	cm	↑ cm	GN	Farbe / Colour	€
50644	53 x 32,5	10	1/1	■ ■	34,20

GN Kuppelhaube / GN cover / GN cúpula / GN cloche bombée

	cm	↑ cm	GN	€
11027	54 x 33	20	1/1	54,00



passend zu Regalwagen 71441
suitable for trolley 71441



GN Kuppelhaube

GN cover
GN cúpula
GN cloche bombée



	cm	↑ cm	GN	€
11070	54 x 33	20	1/1	geschlossen / totally closed cerrada / tolement fermée 52,00
11071	54 x 33	20	1/1	mit Front-Ausschnitt / one long side cut out gran apertura frontal / grande ouverture frontale 54,00
11072	54 x 33	20	1/1	mit seitlichem Ausschnitt / one small side cut out / pequeña apertura lateral / petite ouverture latérale 54,00



GN Abdeckhaube

GN cover
GN cubierta
GN cloche



	cm	↑ cm	GN	€
11042	53,0 x 32,5	9,5	1/1	32,00



stabelbar
stackable



Eierkorb „OVO“

egg basket
cesta de huevos
panier à oeufs

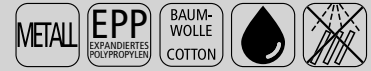

Gestell aus Metall, EPP-Box sorgt für perfekte Wärmeisolierung, Eier werden lange warm gehalten, inklusive waschbarem Stoffeinsatz

metal frame, EPP box ensures perfect heat insulation, Eggs are kept warm for a long time, including washable fabric insert
estructura de metal, la caja de EPP garantiza un perfecto aislamiento térmico, los huevos se mantienen calientes durante mucho tiempo, incluye inserto de tela lavable
structure en métal, la boîte EPP assure une isolation thermique parfaite, les oeufs sont maintenus au chaud pendant longtemps, insert en tissu lavable inclus

	Ø cm	↑ cm	Farbe / Colour	€
30480	23	31	black	29,00

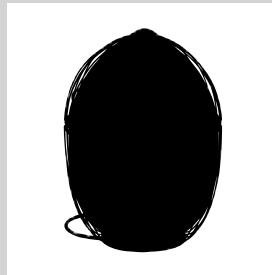

für ca. 35 Eier
for approx. 35 eggs



Eierkorb „PROFI LINE“

egg basket
cesta de huevos
panier à oeufs



mit Edelstahldraht im Rand, für ca. 20 Eier, hält den Inhalt durch das Stofffutter lange warm
with stainless steel wire in the rim, for around 20 eggs, keeps the eggs warm thanks to the fabric lining

con alambre de acero inoxidable en el borde, para unos 20 huevos, mantiene los huevos calientes gracias al forro de tela

avec un fil d'acier inox dans la jante, pour env. 20 oeufs, garde les oeufs au chaud grâce à la doublure en tissu

	Ø cm	↑ cm	Farbe / Colour	€
40299	26	17	black	24,00



Eierkorb

egg basket
cesta de huevos
panier à oeufs



stabile Vollweide, für ca. 20 Eier, hält den Inhalt durch das Stofffutter lange warm

stable willow, for around 20 eggs, keeps the eggs warm thanks to the fabric lining
saule de estable, para unos 20 huevos, mantiene los huevos calientes gracias al forro de tela
saule stable, pour env. 20 oeufs, garde les oeufs au chaud grâce à la doublure en tissu

	Ø cm	↑ cm	Farbe / Colour	€
30299	26	17	yellow	21,00

BREAD BASKETS



Brottasche
bread basket
panera
corbeille



eckig, 70% Naturfaser und 30% Kunstharz
angular, 70% natural fibre and 30% synthetic resin
ángulo, 70% fibra natural y 30% resina sintética
carré, 70% de fibres naturelles et 30% de résine synthétique

	cm	↑ cm	Farbe / Colour	€
30355	12 x 11,5	11,5		6,80
30356	12 x 11,5	11,5		6,80

rund, 70% Naturfaser und 30% Kunstharz
round, 70% natural fibre and 30% synthetic resin
redondo, 70% fibra natural y 30% resina sintética
ronde, 70% de fibres naturelles et 30% de résine synthétique

	Ø cm	↑ cm	Farbe / Colour	€
30440	17	11		7,20
30450	20	13		8,20
30441	17	11		7,20
30451	20	13		8,20



Brottasche
bread basket
panera
corbeille



schmutzabweisende Kunstfaser, 30°C waschbar, wendbar
dirt-repellent synthetic fibre, washable 30°C, reversible
fibra sintética repelente a la suciedad, lavable a 30°C, reversible
fibre synthétique anti-salissante, lavable à 30°C, réversible

	Ø cm	↑ cm	Farbe / Colour	€
30345	17	11,5		8,40
30346	20	13,5		10,40



Brottasche
bread basket
panera
corbeille



schmutzabweisende Kunstfaser, 30°C waschbar, wendbar
dirt-repellent synthetic fibre, washable 30°C, reversible
fibra sintética repelente a la suciedad, lavable a 30°C, reversible
fibre synthétique anti-salissante, lavable à 30°C, réversible

	cm	↑ cm	Farbe / Colour	€
30347	19 x 11	10,5		9,30
30348	24 x 16	10,5		11,50



Präsentationsmöglichkeit
presentation example



Brottasche
bread basket
panera
corbeille à pain en toile



umgekrepelt kann die Höhe individuell gestaltet werden, maschinenwaschbar bis 30°C
adjustable height by turning the edge upside down, machine-washable 30°C
altura ajustable girando el borde al revés, lavable a máquina 30°C
hauteur ajustable en tournant le bord à l'envers, lavable en machine maxi 30°C

	Ø cm	↑ cm	Farbe / Colour	€
30340	17	11		7,00
30350	20	12		7,70
30341	17	11		7,00
30351	20	12		7,70

	cm	↑ cm	Farbe / Colour	€
30360	20 x 15	10		7,30
30370	25 x 18	12		8,30
30361	20 x 15	10		7,30
30371	25 x 18	12		8,30

BREAD BASKETS



30380

30390

Brottasche mit Wärmekissen

bread basket with stones pillow

panera con cojin

corbeille à pain en toile avec coussin chauffant



Baumwolle, Keramik-Kugeln, maschinenwaschbar bis 30°C, mit Zugverschluss, Wärmekissen kann einfach in der Mikrowelle erhitzt werden (90 Sekunden / 500 Watt)

cotton, ceramic balls, machine washable up to 30°C, with drawstring closure, heat pad can easily be heated in the microwave (90 seconds / 500 watts)

algodón, bolas de cerámica, lavable a máquina hasta 30°C, con cierre de cordón, la almohadilla térmica se puede calentar fácilmente en el microondas (90 segundos / 500 vatios)

coton, billes en céramique, lavable en machine jusqu'à 30°C, avec fermeture à tirette, le coussin chauffant peut être facilement chauffé au micro-ondes (90 secondes / 500 watts)

	Ø cm	↑ cm	Farbe / Colour	€
30380	19	23		21,00
30390	19	23		21,00

Wärmekissen / stones pillow / cojín de piedrecillas a calentar / coussin de petites pierres, à chauffer

	Ø cm	↑ cm	€
30385	19	1,5	5,90



30395

30396

Häkelkorb

crochet rope basket

cesta de ganchillo

panier au crochet

umgekrempelt kann die Höhe individuell eingestellt werden

adjustable height by turning the edge upside down

altura ajustable girando el borde al revés

hauteur ajustable en tournant le bord à l'envers



	cm	↑ cm	€
30395	20 x 13,5	10	8,50
30396	24 x 17,5	12	9,40



Präsentationsmöglichkeit
presentation example



Baguettekorb „URBAN“

baguette basket
cesta para baguette
corbeille pour baguettes



Gestell aus Metall, mit Antirutsch-Füßchen

frame made of metal, with non-slip feet
estructura de metal, con pies antideslizantes
structure en métal, avec pieds antidérapants

	Ø cm	↑ cm	€
30211	22,5	28	26,00



Brot- und Obstkorb

basket for bread or fruits
cesta para pan o fruta
corbeille à pain ou à fruits



inklusive Tasche aus Baumwolle, beige grau, maschinenwaschbar bis 30 Grad

incl. bag made of cotton, beige, grey, machine washable up to 30°C
bolsa incluida, de algodón, beige, gris, lavable a máquina hasta 30°C
sac inclus en coton, beige, gris, lavable en machine jusqu'à 30°C

	Ø cm	↑ cm	€
30209	27,5	18,5	32,00



stapelbar
stackable

rutschfest inklusive Klipp
non-slip, includes clip



Eierkorb „OVO“

egg basket
cesta de huevos
panier à oeufs



Gestell aus Metall, EPP-Box sorgt für perfekte Wärmeisolierung, Eier werden lange warm gehalten, inklusive waschbarem Stoffeinsatz

metal frame, EPP box ensures perfect heat insulation, Eggs are kept warm for a long time, including washable fabric insert
estructura de metal, la caja de EPP garantiza un perfecto aislamiento térmico, los huevos se mantienen calientes durante mucho tiempo, incluye inserto de tela lavable
structure en métal, la boîte EPP assure une isolation thermique parfaite, les œufs sont maintenus au chaud pendant longtemps, insert en tissu lavable inclus

	Ø cm	↑ cm	€
30480	23	31	29,00

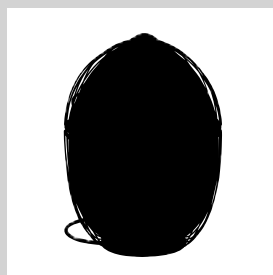

für ca. 35 Eier
for approx. 35 eggs

SVART



Korb „SVART“
basket
cesta
corbeille



	cm	↑ cm	Farbe / Colour	€
30424	29,5 x 25,5	13,5	■	26,00



Korb „SVART“
basket
cesta
corbeille



	cm	↑ cm	Farbe / Colour	€
30422	20 x 15	8	■	13,00
30423	24 x 19	8	■	17,80



Korb „SVART“
basket
cesta
corbeille



	Ø cm	↑ cm	Farbe / Colour	€
30420	17,5	8	■	13,00
30421	20,0	8	■	15,00

SVART



Korb „SVART“

basket
cesta
corbeille



Farbe: smoke green / colour: smoke green / color: verde oscuro / couleur: vert foncé

	Ø cm	↑ cm	Farbe / Colour	€
30470	17,5	8		13,00
30471	20,0	8		15,00



Korb „SVART“

basket
cesta
corbeille



Farbe: smoke green / colour: smoke green / color: verde oscuro / couleur: vert foncé

	cm	↑ cm	Farbe / Colour	€
30472	20 x 15	8		13,00
30473	24 x 19	8		17,80



SVART



30425

30426

Korb „SVART“

basket
cesta
corbeille



Farbe: whisper white / colour: whisper white / color: blanco crema / couleur: blanc-crème

	Ø cm	↑ cm	Farbe / Colour	€
30425	17,5	8	<input type="checkbox"/>	13,00
30426	20,0	8	<input type="checkbox"/>	15,00



30427

30428

Korb „SVART“

basket
cesta
corbeille



Farbe: whisper white / colour: whisper white / color: blanco crema / couleur: blanc-crème

	cm	↑ cm	Farbe / Colour	€
30427	20 x 15	8	<input type="checkbox"/>	13,00
30428	24 x 19	8	<input type="checkbox"/>	17,80



Korb „SVART“

basket
cesta
corbeille



Farbe: whisper white / colour: whisper white / color: blanco crema / couleur: blanc-crème

	cm	↑ cm	Farbe / Colour	€
30429	29,5 x 25,5	13,5	<input type="checkbox"/>	26,00

SVART



Korb „SVART“

basket
cesta
corbeille



Farbe: dream blue / colour: dream blue / color: azul / couleur: bleu

	Ø cm	↑ cm	Farbe / Colour	€
30452	17,5	8		13,00
30453	20,0	8		15,00



Korb „SVART“

basket
cesta
corbeille



Farbe: dream blue / colour: dream blue / color: azul / couleur: bleu

	cm	↑ cm	Farbe / Colour	€
30454	20 x 15	8		13,00
30455	24 x 19	8		17,80



URBAN

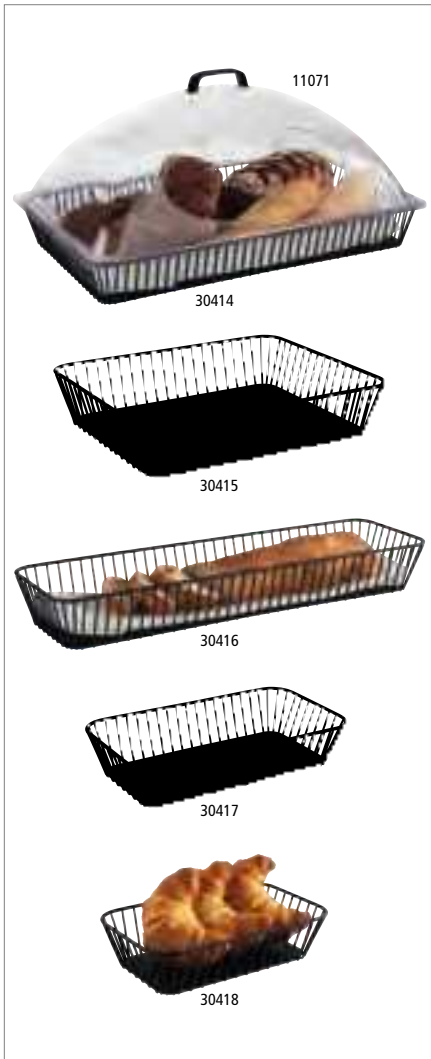

GN Korb „URBAN“

GN basket
GN cesta
GN corbeille



	cm	↑ cm	GN	Farbe / Colour	€
30414	53,0 x 32,5	7,5	1/1	■	35,00
30415	32,5 x 26,5	7,5	1/2	■	26,00
30416	53,0 x 16,2	7,5	2/4	■	26,00
30417	32,5 x 17,6	7,5	1/3	■	19,00
30418	26,5 x 16,2	7,5	1/4	■	16,00



Korb „URBAN“

basket
cesta
corbeille



	Ø cm	↑ cm	Farbe / Colour	€
30410	17	7,0	■	14,40
30411	20	8,5	■	18,00



Korb „URBAN“
basket
cesta
corbeille



	cm	↑ cm	Farbe / Colour	€
30337	29 x 16	7	■	19,00



Korb „URBAN“
basket
cesta
corbeille



	cm	↑ cm	Farbe / Colour	€
30412	21 x 10	7	■	12,80
30413	30 x 14	12	■	21,00

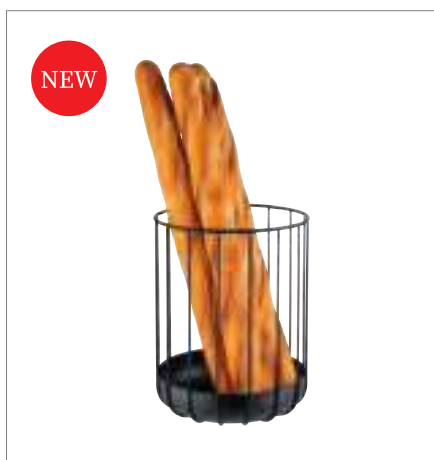

NEW

Baguettekorb „URBAN“
baguette basket
cesta para baguette
corbeille pour baguettes



Gestell aus Metall, mit Antirutsch-Füßchen
frame made of metal, with non-slip feet
estructura de metal, con pies antideslizantes
structure en métal, avec pieds antidérapants

	Ø cm	↑ cm	€
30211	22,5	28	26,00



11071 GN 1/1

11072 GN 1/1

11073 GN 1/2

11074 GN 1/2

GN Kuppelhaube

GN cover
GN cúpula
GN cloche bombée



glasklarer Kunststoff, Griff aus Zinkdruckguss

crystal clear plastic, die-cast zinc knob
plástico transparente, asa de zinc fundido a presión
plastique transparente, poignée en zinc moulé sous pression

	cm	↑ cm	GN		€
11070	54 x 33	20	1/1	geschlossen / totally closed cerrada / totalmente fermée	52,00
11071	54 x 33	20	1/1	mit Front-Ausschnitt / one long side cut out gran apertura frontal grande ouverture frontale	54,00
11072	54 x 33	20	1/1	mit seitlichem Ausschnitt one small side cut out pequeña apertura lateral petite ouverture latérale	54,00
11073	33 x 28	17	1/2	geschlossen / totally closed cerrada / totalmente fermée	29,00
11074	33 x 28	17	1/2	mit Front-Ausschnitt / one long side cut out gran apertura frontal grande ouverture frontale	32,00





URBAN



GN Korb „URBAN“

GN basket

GN cesta

GN corbeille



Farbe: whisper white / colour: whisper white / color: blanco crema / couleur: blanc-crème

	cm	↑ cm	GN	Farbe / Colour	€
30435	53,0 x 32,5	7,5	1/1		35,00
30436	32,5 x 26,5	7,5	1/2		26,00
30439	53,0 x 16,2	7,5	2/4		26,00
30437	32,5 x 17,6	7,5	1/3		19,00
30438	26,5 x 16,2	7,5	1/4		16,00



Korb „URBAN“

basket

cesta

corbeille



Farbe: whisper white / colour: whisper white / color: blanco crema / couleur: blanc-crème

	Ø cm	↑ cm	Farbe / Colour	€
30430	17	7,0		14,40
30431	20	8,5		18,00

SPHERE

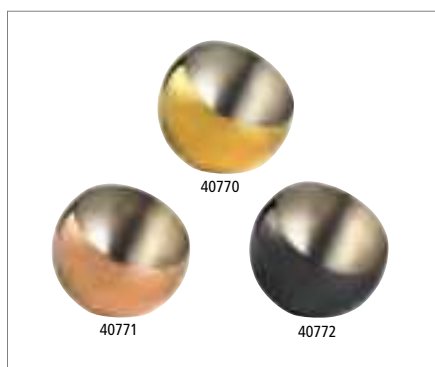

Schale, 3er Set „SPHERE“

bowl, 3 pcs.
cuenco, set de 3
bol, set of 3

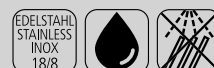

innen: mattiert / inside: matt / interior: mate / intérieur: mat

	Ø cm	↑ cm	ltr.	Farbe / Colour	pcs.	€ / set
40770	8	7	0,1	gold	3	29,00
40771	8	7	0,1	copper	3	29,00
40772	8	7	0,1	gunmetal	3	29,00

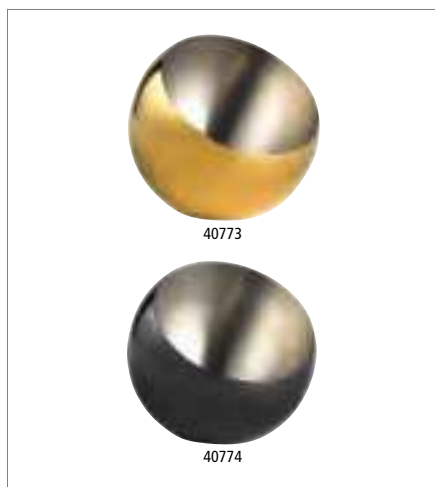

Schale „SPHERE“

bowl
cuenco
bol



innen: mattiert / inside: matt / interior: mate / intérieur: mat

	Ø cm	↑ cm	ltr.	Farbe / Colour	€
40773	16	15	0,8	gold	23,00
40774	16	15	0,8	gunmetal	23,00

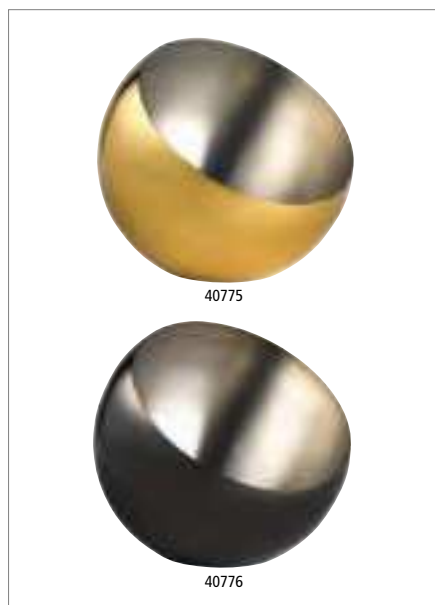

Schale „SPHERE“

bowl
cuenco
bol



innen: mattiert / inside: matt / interior: mate / intérieur: mat

	Ø cm	↑ cm	ltr.	Farbe / Colour	€
40775	24	21	2	gold	34,00
40776	24	21	2	gunmetal	34,00

BASKETS



Baguettekorb „URBAN“

baguette basket
cesta para baguette
corbeille pour baguettes

Gestell aus Metall, mit Antirutsch-Füßchen

frame made of metal, with non-slip feet
estructura de metal, con pies antideslizantes
structure en métal, avec pieds antidérapants



	Ø cm	↑ cm	€
30211	22,5	28	26,00



Brot- und Obstkorb

basket for bread or fruits
cesta para pan o fruta
corbeille à pain ou à fruits

inklusive Tasche aus Baumwolle, beige grau, maschinenwaschbar bis 30 Grad

incl. bag made of cotton, beige, grey, machine washable up to 30°C
bolsa incluida, de algodón, beige, gris, lavable a máquina hasta 30°C
sac inclus en coton, beige, gris, lavable en machine jusqu'à 30°C



	Ø cm	↑ cm	€
30209	27,5	18,5	32,00

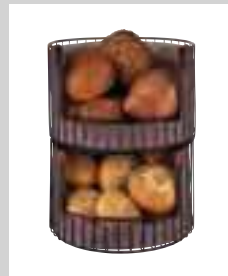

stapelbar
stackable



rutschfest inklusive Klipp
non-slip, includes clip



Brot- und Obstkorb

basket for bread or fruits
cesta para pan o fruta
corbeille à pain ou fruits



	Ø cm	↑ cm	€
30207	21	16,5	13,20
30208	30	19,0	16,40



Brot- und Obstkorb „WIRE“

wire basket
cesta para pan o fruta
corbeille pour pain ou fruits



	Ø cm	↑ cm	€
30206	31	14	15,80

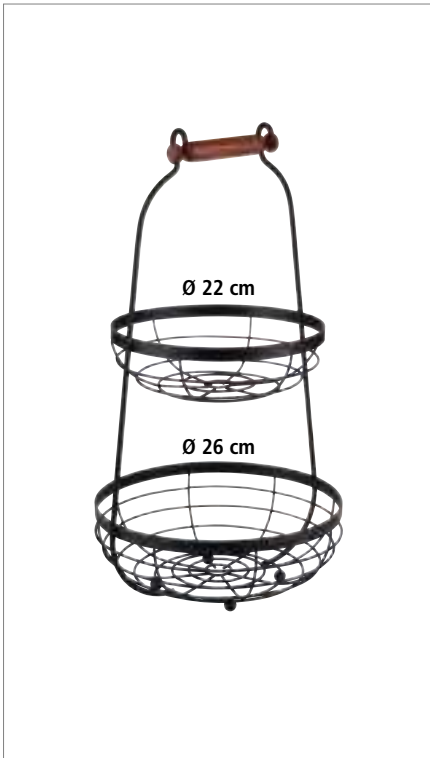

2-stufige Etagère
2-tier étagère
cesta doble 2 alturas
étagère 2 paniers

METALL HOLZ
WOOD

Griff aus Holz, Körbe aus Metall schwarz,
oberer Korb (Ø 22 cm, H: 6 cm), unterer Korb (Ø 26 cm, H: 8 cm)
wooden handle, baskets made of metal black,
upper basket (Ø 22 cm, H: 6 cm), lower basket (Ø 26 cm, H: 8 cm)
asa de madera, cestas de metal negro,
cesta superior (Ø 22 cm, H: 6 cm), cesta inferior (Ø 26 cm, H: 8 cm)
manche en bois, corbeilles en métal noir,
corbeille supérieure (Ø 22 cm, H: 6 cm), corbeille inférieure (Ø 26 cm, H: 8 cm)

	Ø cm	↑ cm	€
30335	26	48	42,00



Präsentationsmöglichkeiten
presentation examples



2-stufige Etagère „ALL-ROUNDER“, 5-teilig
2-tier tray, 5 pcs.
soporte 2 alturas, set de 5
étagère 2 niveaux, set de 5

METALL HOLZ
WOOD

5 teiliges Set:
• 1 Gestell aus Metall schwarz, mit Antirutschfüßchen,
• 2 Körbe aus Metall schwarz je 29 x 16 cm, H: 7 cm,
• 2 herausnehmbare Bretter aus geöltem Akazienholz je 28,5 x 15,5 cm, H: 1,5 cm
5 pcs.:
• 1 frame made of black metal with non-slip feet,
• 2 removable baskets of black metal each 29 x 16 cm, H: 7 cm,
• 2 boards of oiled acacia wood each 28,5 x 15,5 cm, H: 1,5 cm
set de 5:
• 1 soporte metálico, negro con pies antideslizantes,
• 2 cestas metálicas negras, cada una de 29 x 16 cm, H: 7 cm,
• 2 tablas de madera de acacia aceitada 28,5 x 15,5 cm, H: 1,5 cm
set de 5:
• 1 support métallique noir avec pieds antidérapants,
• 2 paniers métalliques noirs, chacune 29 x 16 cm, H: 7 cm,
• 2 planches d'acacia huilé, chacune 28,5 x 15,5 cm, H: 1,5 cm

	cm	↑ cm	€
30336	31 x 17	37,5	64,00



Präsentationsmöglichkeiten
presentation examples

STAINLESS STEEL BASKETS



Brot- und Obstkorb
 basket for bread or fruits
 cesta para pan o fruta
 corbeille à pain ou à fruits
hochglanzpoliert
 mirror polished finish
 acabado pulido brillante
 brillant



	Ø cm	↑ cm	€
30200	17,5	7,0	12,60
30220	20,5	8,5	15,40
30230	25,5	9,5	17,20



Brot- und Obstkorb
 basket for bread or fruits
 cesta para pan o fruta
 corbeille à pain ou à fruits
hochglanzpoliert
 mirror polished finish
 acabado pulido brillante
 brillant



	cm	↑ cm	€
30210	20 x 15	7,0	12,60
30240	24 x 19	8,5	15,40
30250	28 x 21	9,5	17,20

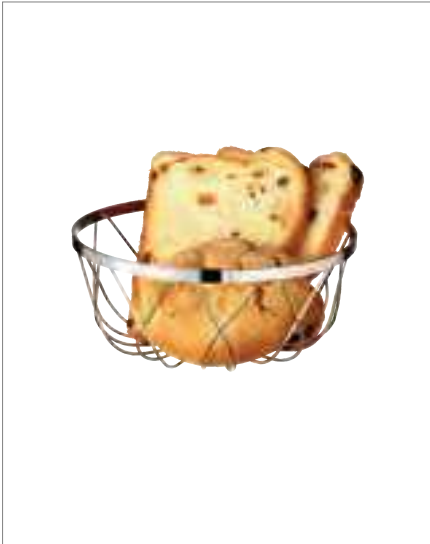

Brot- und Obstkorb
 basket for bread or fruits
 cesta para pan o fruta
 corbeille à pain ou fruits



	Ø cm	↑ cm	€
30310	18	7,5	6,20



30276



30277

Brot- und Obstschale
 bowl for bread or fruits
 bol para pan o fruta
 bol à pain ou à fruits



hochglanzpoliert, gehämmert
 mirror polished finish, hammered
 acabado pulido efecto espejo, martillada
 brillant, martelée

	Ø cm	↑ cm	€
30276	16	5,0	4,00
30277	20	5,5	6,40

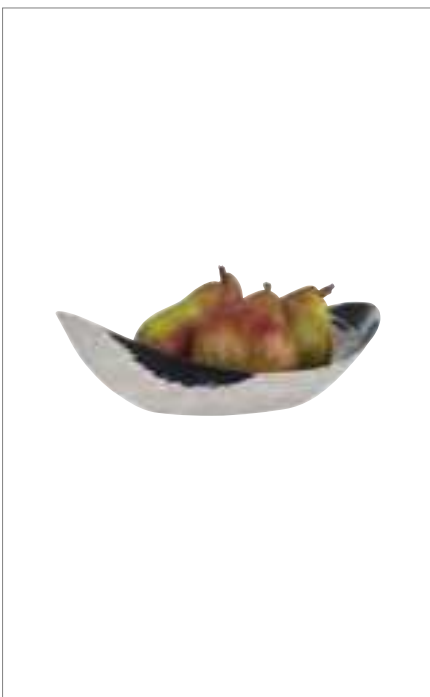

Schale
 bowl
 cuenco
 bol



hochglanzpoliert, gehämmert
 mirror polished finish, hammered
 acabado pulido efecto espejo, martillada
 brillant, martelée

	cm	↑ cm	ltr.	€
40190	24 x 16,5	7	0,45	10,60

BASKETS / RISERS









Korb / Ständer „APS PLUS“

basket / riser

cesta / soporte

corbeille / support



	Ø cm	↑ cm	Farbe / Colour	€
15336	15	10,5	 black	23,00
15337	21	20,0	 black	35,00
15331	15	10,5	 polished chrome	26,80
15332	21	20,0	 polished chrome	43,70
15334	15	10,5	 brushed gold	26,80
15335	21	20,0	 brushed gold	43,70

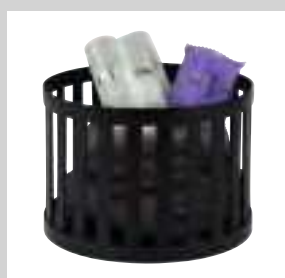

Präsentationsmöglichkeit
presentation example



Besteckbehälter / Korb „UTENSILO“

cutlery bin / basket
 porta cubiertos / cesta
 range-couverts / corbeille



matt poliert, Boden: 29 x 8,5 cm, mit Kunststoffeinsatz

matt polished, base: 29 x 8,5 cm, with plastic insert
 pulido mate, base: 29 x 8,5 cm, con inserto de plástico
 poli mat, fond: 29 x 8,5 cm, avec insert en plastique

	cm	↑ cm	ltr.	Farbe / Colour	€
11752	29,5 x 12	10	2		11,50



mit Kunststoffeinsatz
 with plastic insert



Präsentationsmöglichkeit
 presentation example



Besteckbehälter / Korb „UTENSILO“

cutlery bin / basket
 porta cubiertos / cesta
 range-couverts / corbeille



Boden: 29 x 8,5 cm, mit Kunststoffeinsatz

base: 29 x 8,5 cm, with plastic insert
 base: 29 x 8,5 cm, con inserto de plástico
 fond: 29 x 8,5 cm, avec insert en plastique

	cm	↑ cm	ltr.	Farbe / Colour	€
11753	29,5 x 12	10	2		13,00



mit Kunststoffeinsatz
 with plastic insert



Präsentationsmöglichkeit
 presentation example



Besteckbehälter / Korb „UTENSILO“

cutlery bin / basket
 porta cubiertos / cesta
 range-couverts / corbeille



Boden: 29 x 8,5 cm, mit Kunststoffeinsatz

base: 29 x 8,5 cm, with plastic insert
 base: 29 x 8,5 cm, con inserto de plástico
 fond: 29 x 8,5 cm, avec insert en plastique

	cm	↑ cm	ltr.	Farbe / Colour	€
11754	29,5 x 12	10	2		13,00



mit Kunststoffeinsatz
 with plastic insert



Präsentationsmöglichkeit
 presentation example





Chafing Dish, GN Container & Transport

5 STARS	442
BONFIRE	436
COFFEE DISPENSER	447
CUTLERY BOXES	462
CUTLERY RESTS	465
DOUGH BALL CONTAINERS	466
EASY INDUCTION	430
ELECTRIC CHAFING DISHES	434
GN CONTAINERS MELAMINE	458
GN CONTAINERS POLYCARBONATE	454
GN CONTAINERS POLYPROPYLENE	453
GN CONTAINERS PORCELAIN	456
GN CONTAINERS STAINLESS STEEL	448
GLOBE	426
INDUCTION PLATES	439
INDUCTION STATIONS	438
ORBIT	437
PREMIUM	424
SAMOVAR	446
SERVING TROLLEYS	460
SOUP WARMERS	435
WARMERS	440

PREMIUM



langlebige Deckelbremse
Abnehmbarer Deckel, dieser lässt sich spielend leicht öffnen und schließen, der Lauf des Deckels wird professionell gedämpft.



Kondenswasser - Rücklaufsystem
Kondenswasser wird in das Wasserbecken zurückgeführt.



Sandwichboden / Kapselboden
Induktionsfähiger Boden, direkt auf dem Induktionskochfeld einsetzbar. Perfekte Wärmeverteilung und Steuerung.



Fixierschraube / Rutschsicherung
Höhenverstellbares Gelenk, fixiert das Gerät in dem Gestell und auf dem Tisch.



Induktionskochplatte Nr. 12295
Induktionskochplatte wird einfach in das Gestell gelegt.



stapelbar
Chafing Dish Rahmen sind übereinander stapelbar. Platzsparend und rutschfest stapeln und transportieren.

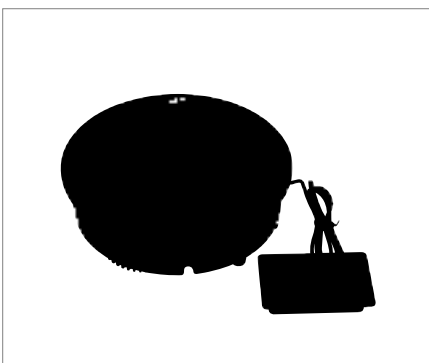

Induktionskochplatte für Chafing Dish

induction plate for chafing dish
placa de inducción para chafing dish
plaque à induction pour chafing dish

mit Regler
with power control
con control de potencia
avec régulateur



	Ø cm		€
12295	24	900 W	139,00



Lieferung ohne Induktionskochplatte
 delivery without induction plate
 se entrega sin placa de inducción
 livré sans plaque à induction

GN 1/1 Chafing Dish „PREMIUM“



1 Gestell + 1 Wasserbecken mit Sandwichboden + 1 Wasserbeckenrahmen + 1 Deckel mit hydraulischem Gelenk + 1 GN 1/1 Behälter 65 mm tief, hitzebeständige Griffe, hochwertige Verarbeitung, ausschließlich für Induktionskochfelder

1 frame + 1 waterpan with sandwich base + 1 frame for waterpan + 1 hydraulic cover + 1 GN 1/1 container 65 mm, heat resistant handles, high quality, only for induction plates

1 soporte + 1 cubeta baño maría con base sandwich + 1 marco para cubeta baño maría + 1 tapa hidráulica + 1 cubeta GN 1/1 de 65 mm, asas resistentes al calor, acabado de alta calidad, solamente para inducción

1 pied support + 1 bac bain-marie avec fond sandwich + 1 cadre pour bac bain-marie + 1 couvercle hydraulique + 1 bac GN 1/1 de 65 mm, poignées résistantes à la chaleur, finition de qualité, uniquement pour induction

	cm	↑ cm	ltr.		€
12352	66 x 48	33	9	mit Glasdeckel with glass cover	1140,00



Lieferung ohne Induktionskochplatte
 delivery without induction plate
 se entrega sin placa de inducción
 livré sans plaque à induction

Chafing Dish rund „PREMIUM“



1 Gestell + 1 Wasserbecken mit Sandwichboden + 1 Wasserbeckenrahmen + 1 Deckel mit hydraulischem Gelenk + 1 runder Speisenbehälter, hitzebeständiger Griff, hochwertige Verarbeitung, ausschließlich für Induktionskochfelder

1 frame + 1 waterpan with sandwich base + 1 frame for waterpan + 1 hydraulic cover + 1 round foodpan, heat resistant handle, high quality, only for induction plates

1 soporte + 1 cubeta baño maría con base sandwich + 1 marco para cubeta baño maría + 1 tapa hidráulica + 1 cubeta redonda, asa resistente al calor, acabado de alta calidad, solamente para inducción

1 pied support + 1 bac bain-marie avec fond sandwich + 1 cadre pour bac bain-marie + 1 couvercle hydraulique + 1 bac rond, poignée résistante à la chaleur, finition de qualité, uniquement pour induction

	cm	↑ cm	ltr.		€
12353	44 x 54	33	6	mit Glasdeckel with glass cover	890,00

Speiseneinsatz / foodpan / cubeta / bac supérieur

	€
12366	24,00



Lieferung ohne Induktionskochplatte
 delivery without induction plate
 se entrega sin placa de inducción
 livré sans plaque à induction

Chafing Dish rund „PREMIUM“



1 Gestell + 1 Wasserbecken mit Sandwichboden + 1 Wasserbeckenrahmen + 1 Deckel mit hydraulischem Gelenk + 1 runder Speisenbehälter, hitzebeständige Griffe, hochwertige Verarbeitung, ausschließlich für Induktionskochfelder

1 frame + 1 waterpan with sandwich base + 1 frame for waterpan + 1 hydraulic cover + 1 round foodpan, heat resistant handles, high quality, only for induction plates

1 soporte + 1 cubeta baño maría con base sandwich + 1 marco para cubeta baño maría + 1 tapa hidráulica + 1 cubeta redonda, asas resistentes al calor, acabado de alta calidad, solamente para inducción

1 pied support + 1 bac bain-marie avec fond sandwich + 1 cadre pour bac bain-marie + 1 couvercle hydraulique + 1 bac rond, poignées résistantes à la chaleur, finition de qualité, uniquement pour induction

	cm	↑ cm	ltr.		€
12354	44 x 48	39	10	mit Glasdeckel with glass cover	890,00

Speisenbehälter / foodpan / cubeta superior / bac supérieur

	€
12397	22,00

GLOBE



die Deckelbremse sorgt für langsames Schließen
 the revolving cover closes gently, thanks to a special built-in axle
 sistema de freno para un cierre suave de la tapa
 système avec frein pour une fermeture en douceur du couvercle



abnehmbarer Glas-Deckel mit Wasserrücklaufsystem
 removable glass lid, with water-runback-system
 tapa transparente desmontable con sistema de retorno de la condensación
 couvercle transparent amovible avec système de retour de la condensation



Kondenswasser wird in das Wasserbecken zurückgeführt
 condensed water is led back into the waterpan
 el agua de condensación vuelve a la cubeta de agua
 l'eau de condensation retourne dans le bac d'eau



für alle Herdarten geeignet, auch für Induktionskochplatten
 suitable for all kinds of ovens, even induction cookers
 apto para todas las fuentes de calor, incluso inducción
 apte pour toutes les sources de chaleur, y compris induction

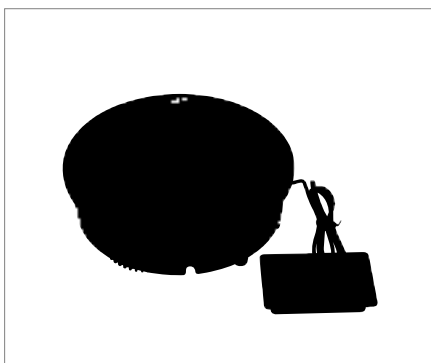

Induktionskochplatte für Chafing Dish

induction plate for chafing dish
 placa de inducción para chafing dish
 plaque à induction pour chafing dish

mit Regler
 with power control
 con control de potencia
 avec régulateur

	Ø cm		€
12295	24	900 W	139,00



12404



12295



12296

GN 1/1 Chafing Dish „GLOBE“



hochglanzpoliert, mit abnehmbarem hydraulischem Edelstahl-Deckel, Sandwichboden sorgt für optimale Wärmeleitung, für Induktionsplatten geeignet, Set: Gestell + Wasserbecken + Speisenbehälter GN 1/1 65 mm tief, 9 Liter + Löffelablage + 2 Brennpastenbehälter + Metallrahmen für Induktionskochplatte

mirror polished finish, removable stainless steel hydraulic cover, sandwich base for optimum heat distribution, suitable for induction plates

set: frame + waterpan + GN 1/1 container 65 mm, 9l + cutlery compartment ladles + 2 burner holder + frame for induction plate

pulido brillante, tapa hidráulica de acero inoxidable extraíble, fondo difusor sandwich apto para inducción, incluye: soporte + cubeta baño maría + cubeta GN 1/1 de 65 mm, 9 l + soporte para cuchara (sin cuchara) + 2 quemadores + marco para la placa de inducción

poli brillant, couvercle inox hydraulique amovible, fond diffuseur sandwich apte pour induction, comprend: pied support + bac bain-marie + bac GN 1/1 de 65 mm, 9 l + porte-louche (louche non incluse) + 2 brûleurs + cadre inox pour la plaque à induction

	cm	↑ cm	ltr.		€
12404	66,5 x 44	34	9	mit Glasdeckel with glass cover	624,00

Induktionskochplatte für Chafing Dish / induction plate for chafing dish / placa de inducción para chafing dish / plaque à induction pour chafing dish

12295					139,00
-------	--	--	--	--	--------

Metallrahmen für Induktionskochplatte / frame for induction plate / estructura o marco para placa de inducción / cadre support inox pour plaque induction

12296					19,40
-------	--	--	--	--	-------



GN 2/3 Chafing Dish „GLOBE“



hochglanzpoliert, mit abnehmbarem hydraulischem Edelstahl-Deckel, Sandwichboden sorgt für optimale Wärmeleitung, für Induktionsplatten geeignet, Set: Gestell + Wasserbecken + 1 GN 2/3 Behälter 65 mm tief + Löffelablage + 1 Brennpastenbehälter + 1 Metallrahmen für Induktionskochplatte

mirror polished finish, removable hydraulic cover, sandwich base, optimum heat distribution, set: frame + waterpan + foodpan GN 2/3, 65 mm, 5,5 l + compartment for ladles + burner holder + frame for induction plate

pulido brillante, con tapa hidráulica extraíble, fondo difusor sandwich apto para inducción. Incluye: 1 pie, 1 cubeta baño maría, 1 cubeta GN 2/3 65 mm - 5,5 l, 1 soporte para cuchara (sin cuchara), 1 quemador, marco inox para la placa de inducción

poli brillant, couvercle hydraulique amovible, fond diffuseur sandwich apte pour induction. Comprend: pied, cuve bain-marie, bac inox GN 2/3-65 mm - 5,5 L, porte-louche (louche non incluse), brûleur, cadre inox pour la plaque à induction

	cm	↑ cm	ltr.		€
12484	44 x 41	34	5,5	mit Glasdeckel with glass cover	560,00



Chafing Dish „GLOBE“



hochglanzpoliert, mit abnehmbarem hydraulischen Edelstahl-Deckel, Sandwichboden sorgt für optimale Wärmeleitung, für Induktionsplatten geeignet

Set: Gestell + Wasserbecken + Speisenbehälter rund + Löffelablage + Brennpastenbehälter + Metallrahmen für Induktionskochplatte

mirror polished finish, removable hydraulic cover, sandwich base, optimum heat distribution set: frame + waterpan + foodpan round + cutlery compartment ladles + burner holder + frame for induction plate

pulido brillante, con tapa hidráulica extraíble, fondo difusor sandwich apto para inducción. Incluye: 1 pie, 1 cubeta baño maria, 1 cubeta redonda, 1 soporte para cuchara (sin cuchara), 1 quemador, marco inox para la placa de inducción

brillant, couvercle hydraulique amovible, fond diffuseur sandwich apte pour induction.

Comprend: pied, cuve bain-marie, bac inox rond, porte-louche (louche non incluse), 1 brûleur, cadre inox pour la plaque à induction

	∅ cm	↑ cm	ltr.		€
12403	38,5	34	6	mit Glasdeckel with glass cover	540,00

Induktionskochplatte für Chafing Dish / induction plate for chafing dish / placa de inducción para chafing dish / plaque à induction pour chafing dish

12295	139,00
-------	--------

Metallrahmen für Induktionskochplatten / frame for induction plate / marco para placa de inducción / cadre support inox pour plaque induction

12291	18,30
-------	-------

Speiseneinsatz / foodpan / cubeta / bac supérieur

12366	24,00
-------	-------



Porzellan-Einsatz

porcelain insert

bandeja de porcelana

bac supérieur en porcelaine



	∅ cm	↑ cm	ltr.	fits to	€
82210	39	6	4,3	12324, 12403	82,00
82215	39	6	3,5	12324, 12403	84,00



Suppen-Kugel inkl. Gestell „GLOBE“

soup bowl with stand
cubeta sopa con soporte
récipient à soupe avec pied

hochglanzpoliert, inkl. Speisenbehälter, 1 Brennpastenbehälter, mit einhängbarer Löffelablage, Sandwichboden sorgt für optimale Wärmeverteilung, für Induktionsplatten geeignet, einfaches Anbringen und Entfernen des Deckels, hitzeisolierende Griffe, 1 Metallrahmen für Induktionskochplatten

mirror polished finish, incl. foodpan and 1 burner holder, with fitting compartment for ladles, sandwich bottom for optimum heat distribution, gentle opening of the lid, heat-resistant handles, frame for induction plate

acabado pulido brillante, cubeta sopa inox, 1 quemador, platillo a colgar para el cucharón, fondo difusor sandwich, apto para inducción, tapa con apertura controlada, asas frías, marco para placa de inducción

poli brillant, récipient à soupe inox, 1 brûleur, repose-couvert à accrocher, fond diffuseur sandwich, apte pour induction, couvercle à ouverture contrôlée, anses froides, cadre support inox pour plaque à induction



	Ø cm	↑ cm	ltr.	€
12398	48	45	10	490,00

Induktionskochplatte für Chafing Dish / induction plate for chafing dish / placa de inducción para chafing dish / plaque à induction pour chafing dish

12295				139,00
-------	--	--	--	--------

Metallrahmen für Induktionskochplatten / frame for induction plate / marco para placa de inducción / cadre support inox pour plaque induction

12291				18,30
-------	--	--	--	-------



Suppen-Kugel „GLOBE“

soup bowl
cubeta sopa
récipient à soupe

hochglanzpoliert, inkl. Speisenbehälter, mit einhängbarer Löffelablage, Sandwichboden sorgt für optimale Wärmeverteilung, für Induktionsplatten geeignet, einfaches Anbringen und Entfernen des Deckels, hitzeisolierende Griffe (Lieferung ohne Gestell, Löffel)

mirror polished finish, incl. foodpan, with fitting compartment for ladles, sandwich bottom for optimum heat distribution, gentle opening of the lid, heat-resistant handles (delivery without rack, ladle)

acabado pulido brillante, cubeta sopa inox, platillo a colgar para el cucharón, fondo difusor sandwich, apto para inducción, tapa con apertura controlada, asas frías (cucharón no incluido)

poli brillant, récipient à soupe inox, repose-couvert à accrocher, fond diffuseur sandwich, apte pour induction, couvercle à ouverture contrôlée, anses froides (cadre, louche non incluse)



	Ø cm	↑ cm	ltr.	€
12399	48	32	10	420,00

Gestell inkl. Brenner / frame incl. burner / soporte incluyendo quemador / support, brûleur inclus

12396				90,00
-------	--	--	--	-------

Speisenbehälter / foodpan / cubeta superior / bac supérieur

12397				22,00
-------	--	--	--	-------

EASY INDUCTION



die Deckelbremse sorgt für langsames Schließen

the revolving cover closes gently, thanks to a special built-in axle

sistema de freno para un cierre suave de la tapa

système avec frein pour une fermeture en douceur du couvercle



Druckhebel zum leichten Entnehmen des GN-Behälters

stick for easy removing of the GN-container

dispositivo para levantar y quitar con facilidad la cubeta GN

dispositif pour lever et retirer facilement le bac GN



abnehmbarer Glas-Deckel mit Wasserrücklaufsystem

removable glas lid, with water-runback-system

tapa transparente desmontable con sistema de retorno de la condensación

couvercle transparent amovible avec système de retour de la condensation



Fixierschraube verhindert das Rutschen

fixing screw for skid resistance

Pie trasero anti-deslizante, altura regulable

Pied supplémentaire anti-dérapant réglable en hauteur

Lieferung ohne Induktionskochplatte
delivery without induction plate
se entrega sin placa de inducción
livré sans plaque à induction

GN 1/1 Chafing Dish „EASY INDUCTION“



1 Gestell + 1 Wasserbecken mit Sandwichboden + 1 Deckel mit hydraulischem Gelenk + 1 GN 1/1 Behälter 65 mm tief, hitzebeständige Griffe, hochwertige Verarbeitung, ausschließlich für Induktionskochfelder

1 frame + 1 waterpan with sandwich base + 1 hydraulic cover + 1 GN 1/1 container 65 mm, heat-resistant handles, high quality, only for induction plates

1 marco + 1 baño maría con base sandwich + 1 marco con tapa hidráulica + 1 cubeta GN 1/1 pan 65 mm profundo, asas resistentes al calor, buenos acabados, solamente para inducción

1 pied support + 1 bac bain-marie avec fond sandwich + 1 cadre avec couvercle hydraulique + 1 bac GN 1/1 - 65mm, poignées résistantes à la chaleur, belle qualité, uniquement pour induction

	cm	↑ cm	GN	ltr.	€
12322	60 x 42	30	1/1	9	500,00

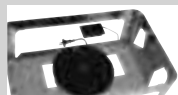

Lieferung ohne Induktionskochplatte
delivery without induction plate
se entrega sin placa de inducción
livré sans plaque à induction

GN 2/3 Chafing Dish „EASY INDUCTION“



1 Gestell + 1 Wasserbecken mit Sandwichboden + 1 Wasserbeckenrahmen + 1 Deckel mit hydraulischem Gelenk + 1 GN 2/3 Behälter 65 mm tief, hitzebeständige Griffe, hochwertige Verarbeitung, ausschließlich für Induktionskochfelder

1 frame + 1 waterpan with sandwich base + 1 frame for waterpan + 1 hydraulic cover + 1 GN 2/3 container 65 mm, heat-resistant handles, high quality, only for induction plates

1 marco + 1 baño maría con base sandwich + 1 marco con tapa hidráulica + 1 cubeta GN 2/3 pan 65 mm profundo, asas resistentes al calor, buenos acabados, solamente para inducción

1 pied support + 1 bac bain-marie avec fond sandwich + 1 cadre avec couvercle hydraulique + 1 bac GN 2/3 - 65mm, poignées résistantes à la chaleur, belle qualité, uniquement pour induction

	cm	↑ cm	GN	ltr.	€
12323	42 x 41	30	2/3	5,5	420,00





Lieferung ohne Induktionskochplatte
delivery without induction plate
se entrega sin placa de inducción
livré sans plaque à induction

Chafing Dish „EASY INDUCTION“



1 Gestell + 1 Wasserbecken mit Sandwichboden + 1 Deckel mit hydraulischem Gelenk
+ 1 runder Speisenbehälter, hitzebeständige Griffe, hochwertige Verarbeitung,
ausschließlich für Induktionskochfelder geeignet

1 frame + 1 waterpan with sandwich base + 1 hydraulic cover + 1 round foodpan,
heat-resistant handles, high quality, good for induction plates

1 soporte + 1 baño maría con base sandwich + 1 tapa hidráulica + 1 cubeta redonda,
asas resistente al calor, buen acabado, apto para inducción

1 pied support + 1 bac bain-marie avec fond sandwich + 1 cadre avec couvercle hydraulique +
1 bac rond, poignées résistantes à la chaleur, belle qualité, uniquement pour induction

	cm	↑ cm	ltr.	€
12324	46 x 50	30	6	410,00



Lieferung ohne Induktionskochplatte
delivery without induction plate
se entrega sin placa de inducción
livré sans plaque à induction

Chafing Dish „EASY INDUCTION“



1 Gestell + 1 Wasserbecken mit Sandwichboden + 1 Deckel mit hydraulischem Gelenk +
1 runder Speisenbehälter, hitzebeständige Griffe, hochwertige Verarbeitung,
ausschließlich für Induktionskochfelder geeignet

1 frame + 1 waterpan with sandwich base + 1 hydraulic cover + 1 round foodpan,
heat-resistant handles, high quality, good for induction plates

1 soporte + 1 baño maría con base sandwich + 1 tapa hidráulica + 1 cubeta redonda,
asas resistente al calor, buen acabado, apto para inducción

1 pied support + 1 bac bain-marie avec fond sandwich + 1 cadre avec couvercle hydraulique +
1 bac rond, poignées résistantes à la chaleur, belle qualité, uniquement pour induction

	cm	↑ cm	ltr.	€
12325	48 x 42	39	11	410,00

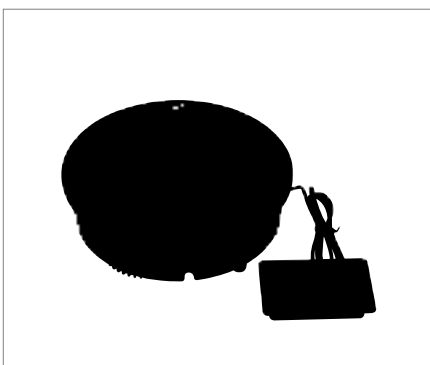

Induktionskochplatte für Chafing Dish

induction plate for chafing dish
placa de inducción para chafing dish
plaque à induction pour chafing dish

mit Regler

with power control

con control de potencia

avec régulateur

	Ø cm		€
12295	24	900 W	139,00

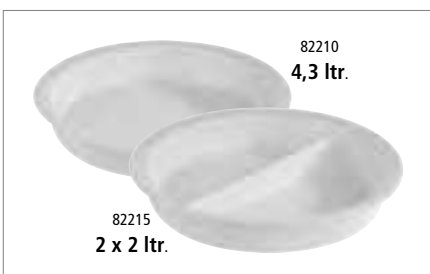

82210
4,3 ltr.

82215
2 x 2 ltr.

Porzellan-Einsatz

porcelain insert
bandeja de porcelana
bac supérieur en porcelaine



	Ø cm	↑ cm	ltr.	fits to	€
82210	39	6	4,3	12324, 12403	82,00
82215	39	6	3,5	12324, 12403	84,00

CHAFING DISHES



Rolltop-Chafing Dish „ELITE“



poliert, Rolltopdeckel klappbar auf 90° und 180°, Speisenbehälter GN 1/1 65 mm tief + Wasserbecken + 2 Brennpastenbehälter, wechseln des GN-Behälters ohne Abnehmen des Deckels (kein Kondenswasser-Rücklaufsystem)

polished, rolltop cover adjustable at 90° and 180°, foodpan GN 1/1 65 mm deep + waterpan + 2 burner holders, change of the GN container without removing the lid (condensed water can not be led back into the waterpan)

pulido brillante, tapa rolltop a 90° o 180°, cubeta GN 1/1 + 2 quemadores, cuba baño maría, se puede cambiar la cubeta GN sin retirar la tapa, importante: el agua condensada no revierte en los alimentos

poli brillant, couvercle rolltop ouverture de 90 a 180°, bac GN 1/1, bain-marie, 2 brûleurs, le bac GN peut être retiré et remplacé sans démonter le couvercle, important: la condensation ne retombe pas sur les aliments

	cm	↑ cm	ltr.	€
12350	67 x 47	45	9	250,00

Wasserbecken inkl. Vorrichtung für Heizelement / waterpan / baño maría / bain-marie

12249				49,00
-------	--	--	--	-------



inkl. Vorrichtung für Heizelement S. 439
incl. screws for heating unit p. 439



Rolltop-Chafing Dish „CATERER“



Speisenbehälter GN 1/1 65 mm tief + Rolltopdeckel 90° + Wasserbecken inkl. Vorrichtung für Heizplatte + 2 Brennpastenbehälter (Lieferung ohne Heizplatte), massiver Ständer

foodpan GN 1/1 65 mm deep + rolltop cover 90° + waterpan with screws for heatingunit + 2 burner holders (without heating unit), stable frame

1 cubeta GN 1/1 - 65 mm + campana rolltop abatible a 90° + 2 quemadores + cuba baño maría con fijaciones para resistencia amovible (se sirve sin la resistencia)

1 bac GN 1/1 - 65 mm + couvercle rolltop ouverture 90° + 2 brûleurs + 1 bac bain-marie avec 4 vis pour fixation résistance de chauffe amovible (non incluse)

	cm	↑ cm	ltr.	€
12245	67 x 35	45	9	228,00

Wasserbecken inkl. Vorrichtung für Heizelement / waterpan / baño maría / bain-marie

12249				49,00
-------	--	--	--	-------

inkl. Vorrichtung für Heizelement S. 439
incl. screws for heating unit p. 439



Rolltop-Chafing Dish „MAESTRO“



Speisenbehälter GN1/1 65 mm tief (passend auch für 100 mm) + Rolltopdeckel 90° + Wasserbecken inkl. Vorrichtung für Heizplatte (S. 404) + 2 Brennpastenbehälter

foodpan GN1/1 65 mm (also for 100 mm) + rolltop cover 90° + waterpan with screws for heating unit (p. 404) + 2 burner holders

cubeta GN 1/1 - 65 mm (hay espacio para una cubeta 100 mm) + campana rolltop abatible a 90° + 2 quemadores

bac GN 1/1 - 65 mm (accepte aussi bac ht. 100 mm) + couvercle rolltop ouverture 90° + 2 brûleurs

	cm	↑ cm	ltr.	€
12300	67 x 35	45	9	200,00

Rolltopdeckel 90°
rolltop cover 90°



inkl. Vorrichtung für Heizelement S. 439
incl. screws for heating unit p. 439

Chafing Dish „CATERER PRO“



Deckel hochglanzpoliert, Deckelgriffe hitzebeständig + 2 Brennpastenbehälter + Wasserbecken, inkl. Vorrichtung für Heizplatte + Gestell mit Deckelhalterung (ohne GN Speisenbehälter)
cover mirror polished finish, cover knob heat-resistant + 2 burner holders
+ waterpan with screws for heating unit + frame with coverholder (without GN foodpan)
tapa pulido brillante, asas frías + 2 quemadores + cuba inferior con tornillos para resistencia removible (no incluida) + tapa y estructura con sujeción de la tapa (se sirve sin la cubeta GN)
couvercle poli brillant, anses froides + 2 brûleurs + bac bain-marie
avec fixations pour résistance amovible (non incluse)

	cm	↑ cm	€
12233	64 x 35	34	150,00

Ersatzdeckel / replacement cover / tapa de recambio / couvercle de rechange

12236			52,00
-------	--	--	-------

Wasserbecken inkl. Vorrichtung für Heizelement / waterpan / baño maría / bain-marie

12249			49,00
-------	--	--	-------



Chafing Dish „CHEF“



Speisenbehälter GN 1/1 65 mm tief + 2 Brennpastenbehälter + Wasserbecken + Deckel + Gestell mit Deckelhalterung + langer Hohlgriff
foodpan GN 1/1 65 mm + 2 burner holders + waterpan
+ cove + frame with coverholder
1 cubeta GN 1/1 65 mm + 2 quemadores + cubeta para el agua
+ tapa y chasis con bloqueo para la tapa
1 bac GN 1/1 - 65 mm + 2 brûleurs + 1 bac bain-marie
+ couvercle + chasis avec blocage couvercle + poignée tube creux

	cm	↑ cm	ltr.	€
11675	61 x 31	30	9	72,00



Brennpastenbehälter

burner holder
soporte para quemador
porte-brûleur



nachfüllbar, für Chafing Dish, Deckel mit Bajonettverschluss

refillable, for Chafing Dish, lid with bayonet lock
recargable, para Chafing Dish, tapa con cierre de bayoneta
rechargeable, pour chafing dish, couvercle avec verrouillage par baïonnette

	Ø cm	↑ cm	€
11683	9	6	6,30

CHAFING DISHES



Elektro-Rolltop-Chafing Dish „ELITE“

electric rolltop chafing dish
chafing dish eléctrico rolltop
chafing dish électrique rolltop



Rolltopdeckel poliert, klappbar auf 90° und 180°, Elektro-Wasserbecken mit Temperaturregelung + Speisenbehälter GN 1/1 100 mm tief, 760 - 900 W, 230 V (kein Kondenswasser-Rücklaufsystem)

rolltop cover polished, adjustable at 90° and 180°, electric waterpan with adjustable heatcontrol + foodpan GN 1/1 100 mm deep, 760 - 900 W, 230 V (condensed water cannot be led back into the waterpan)

tapa abatible pulido brillante, apertura a 90° o 180°, baño maría c/ termostato + cubeta GN 1/1 - 100 mm, 760 - 900 W, 230 V (el agua condensada no gotea dentro de la cubeta)

couvercle rolltop poli brillant, ouverture à 90° ou 180°, bain-marie électrique avec thermostat + bac GN 1/1-100 mm, 760 - 900 W, 230 V (Important: la condensation ne retombe pas sur les aliments)

	cm	↑ cm	ltr.	€
12360	67 x 47	45	14	395,00

Wasserbecken, elektrisch / electric waterpan / baño maria eléctrico / bain-marie électrique

12224				82,00
-------	--	--	--	-------



Elektro Chafing Dish

electric chafing dish
chafing dish eléctrico
chafing dish électrique



Deckel poliert, Elektro-Wasserbecken mit Temperaturregelung + Speisenbehälter GN 1/1 100 mm tief, Deckelhalter, 900 W, 230 V

cover polished, electric waterpan with adjustable heatcontrol + foodpan GN 1/1 100 mm deep, lid holder, 900 W, 230 V

tapa pulido brillante, baño maría c/ termostato + cubeta GN 1/1 - 100 mm, sujeción de la tapa, 900 W, 230 V

couvercle poli brillant, bain-marie électrique avec thermostat + bac GN 1/1-100 mm, blocage du couvercle, 900 W, 230 V

	cm	↑ cm	ltr.	€
12225	63 x 36	29	14	170,00

Deckel / cover / tapa / couvercle

12235				35,00
-------	--	--	--	-------

Wasserbecken, elektrisch / electric waterpan / baño maria eléctrico / bain-marie électrique

12224				82,00
-------	--	--	--	-------



Elektro-Chafing Dish „ECO“

electric chafing dish
chafing dish eléctrico
chafing dish électrique



Deckel poliert, Elektro-Wasserbecken mit Temperaturregelung + Speisenbehälter GN 1/1 65 mm tief, Deckelhalter, 760 - 900 W, 230 V

cover polished, electric waterpan with adjustable heatcontrol + foodpan GN 1/1 65 mm deep, lid holder, 760 - 900 W, 230 V

tapa pulido brillante, baño maría c/ termostato + cubeta GN 1/1 - 65 mm, sujeción de la tapa, 760 - 900 W, 230 V

couvercle poli brillant, bain-marie électrique avec thermostat + bac GN 1/1 - 65 mm, blocage du couvercle, 760 - 900 W, 230 V

	cm	↑ cm	ltr.	€
12232	63 x 36	29	9	139,00

Wasserbecken, elektrisch / electric waterpan / baño maria eléctrico / bain-marie électrique

12224				82,00
-------	--	--	--	-------



Elektrischer Suppentopf

electric soup warmer
marmita de sopa eléctrica
marmite à soupe électrique



herausnehmbarer Einsatz aus Edelstahl, elektrisch, mit Wasserbad + Löffel + integrierter Tragering für den Innenbehälter, Deckel mit hitzeisolierendem Griff, Temperaturregelung 80°C (± 10°C), 450 - 550 W, 230 V

removable soup st. steel pan, bain marie electric, ladle, circular frame, thermostat control till 80°C (± 10°C), 450 - 550 W, 230 V
recipiente sopa inox extraible, baño maria eléctrico + cucharón + aro inox, tapa con asas frías, termostato hasta 80°C precisión (± 10°C), 450 - 550 W, 230 V
récipient à soupe inox amovible, bain-marie électrique, louche, support circulaire inox, thermostat maxi 80°C (± 10°C), 450 - 550 W, 230 V

	Ø cm	↑ cm	ltr.	€
11901	38	36,5	10	148,00



Elektrischer Suppentopf

electric soup warmer
marmita de sopa eléctrica
marmite à soupe électrique



herausnehmbarer Einsatz aus Edelstahl, elektrisch, mit Wasserbad + Löffel + integrierter Tragering für den Innenbehälter, Deckel mit hitzeisolierendem Griff, Temperaturregelung 80°C (± 10°C), 400 - 450 W, 230 V

removable soup st. steel pan, bain marie electric, ladle, st. steel circular frame, thermostat control till 80°C (± 10°C), 400 - 450 W, 230 V
recipiente sopa inox extraible, baño maria eléctrico + cucharón + aro inox, tapa con asas frías, termostato hasta 80°C precisión (± 10°C), 400 - 450 W, 230 V
récipient à soupe inox amovible, bain-marie électrique, louche, support circulaire inox, thermostat maxi 80°C (± 10°C), 400 - 450 W, 230 V

	Ø cm	↑ cm	ltr.	€
11910	40	37	10	148,00



Elektrischer Suppentopf „ECONOMIC“

electric soup warmer
marmita de sopa eléctrica
marmite à soupe électrique



Stahl schwarz lackiert, herausnehmbarer Einsatz aus Edelstahl, mit Wasserbad, Temperaturregelung 30°C - 90°C, dreh- und klappbarer Edelstahl-Deckel, inkl. 8 magnetisch haftenden Beschriftungen, 400 W, 230 V

metal, black, removable soup pot, with bain marie, thermostat 30°C - 90°C, st. steel lid, incl. 8 magnetic signs, 400 W, 230 V
metal negro, recipiente sopa inox extraible, con baño maria, termostato 30°C- 90°C, tapa inox, incluye 8 letreros magnéticos, 400 W, 230 V
acier, noir, récipient à soupe inox amovible, avec bain-marie, thermostat 30°C - 90°C, couvercle inox, 8 étiquettes magnétiques, 400 W, 230 V

	Ø cm	↑ cm	ltr.	€
11915	32	36	9	104,00

Speisenbehälter / foodpan / recipiente sopa / récipient à soupe

11916	28,00
-------	-------

Deckel / cover / tapa / couvercle

11917	15,40
-------	-------



NEW BONFIRE

Die Induktionsstation „Bonfire“ besticht durch ihr ausgefallenes Design: Holzscheite aus schwarzem Eschenholz und ein runder Aufbau aus schwarz-mattem Metall erinnern an ein stilisiertes Lagerfeuer. Ein Hingucker für das besondere Buffet.

The 'Bonfire' induction station impresses with its modern design: logs made of black ash wood and a round structure made of black matt metal are reminiscent of a stylised campfire. An elegant eye-catcher for professional buffet set-ups.

La estación de inducción «Bonfire» impresiona por su diseño moderno: los troncos de madera de fresno negro y la estructura redonda de metal negro mate recuerdan a una estilizada hoguera. Un elegante punto de atracción para el buffet profesional.

La station à induction « Bonfire » séduit par son design moderne: des bûches en bois de frêne noir et une structure ronde en métal noir mat rappellent un feu de camp stylisé. Un accroche-regard élégant pour un buffet professionnel.



Induktionsstation „BONFIRE“

induction station
estación de inducción
station à induction



Induktionskochplatte Ø 24 cm, 900 Watt, inklusive Kabelfernbedienung,
Leistung in Stufen regelbar, Ständer aus Eschenholz und Metall schwarz

induction hotplate Ø 24 cm, 900 watts, cable remote control,
 power adjustable in steps, black ash wood and metal stand

placa de inducción Ø 24 cm, 900 vatios, incluye mando a distancia por cable, potencia regulable en pasos, soporte de madera de fresno negro y metal negro

plaque de cuisson à induction Ø 24 cm, 900 watts, télécommande filaire incluse, puissance réglable par paliers, support en bois de frêne noir et métal noir

	Ø cm	↑ cm		€
12250	46,5	16	900 W	210,00



passend zur Serie „ORBIT“
 suitable for the „ORBIT“ series

4 tlg.
4 pcs.



12342



12343



12330



12335



12336



12337



12338



12339

Chafing Dish, 4-teiliges Set „ORBIT“

chafing dish set, 4 pcs.
chafing dish, set de 4
chafing dish, set de 4



- 1 Topf (8 Liter)
- 1 Speisenbehälter (4 Liter)
- 1 Deckel mit Sichtfenster und 1 Deckelbremse
- Topf mit induktionsfähigem Sandwich- / Kapselboden

- 1 pot (8 litres)
- 1 foodpan (4 litres)
- 1 lid with glass insert and 1 automatic lid brake
- pot with induction-compatible sandwich base
- 1 olla (8 litros)
- 1 cubeta (4 litros)
- 1 tapa con ventanilla y 1 sistema de freno en la tapa
- olla con base sandwich apta para inducción
- 1 casserole (8 litres)
- 1 bac (4 litres)
- 1 couvercle avec fenêtre et 1 système de frein dans le couvercle
- casserole avec fond sandwich pour induction

	Ø cm	↑ cm	ltr.	Farbe / Colour	€
12342 <small>NEW</small>	30,5	17,5	4	vintage-look	314,00
12343 <small>NEW</small>	30,5	17,5	4	gold	314,00
12330	30,5	17,5	4	stainless steel	260,00
12335	30,5	17,5	4	copper	314,00
12336	30,5	17,5	4	yellow	314,00
12337	30,5	17,5	4	red	314,00
12338	30,5	17,5	4	black	314,00
12339	30,5	17,5	4	green	314,00

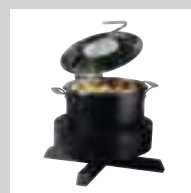
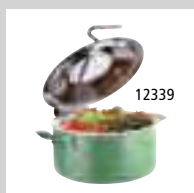

abnehmbarer Deckel
removable lid

induktionsgeeignet
suitable for induction

induktionsgeeignet
suitable for induction

Ersatz-Speisenbehälter zu Chafing Dish / replacement foodpan for chafing dish / cubeta interior de repuesto para chafing dish / bac intérieur de remplacement pour le chafing dish

	Ø cm	↑ cm	ltr.	fits to	€
12329	30,5	8	4	12330, 12335, 12336, 12337, 12338, 12339, 12342, 12343	30,00



8 ltr. Topf
8 ltr. pot



4 ltr. Speisenbehälter
4 ltr. foodpan



Deckelbremse
automatic lid break



Sandwich- / Kapsel-
boden / sandwich base



82212 2 x 1,4 ltr.



82211 3 ltr.

Porzellaneinsatz „ORBIT“

porcelain insert
bandeja de porcelana
bac en porcelaine



	Ø cm	↑ cm	ltr.	fits to	€
82212 <small>NEW</small>	29,5	9	2,8	12330, 12335, 12336, 12337, 12338, 12339, 12342, 12343	62,00
82211	29,5	9	3,0	12330, 12335, 12336, 12337, 12338, 12339, 12342, 12343	56,00



Kochplatte Ø 24 cm
induction station Ø 24 cm

4 tlg.
4 pcs.

12276

12272

12295

15506

Induktionsstation, 4-tlg. Set „VALO“

induction station, 4 pcs.
estación de inducción, set de 4
station d'induction, set de 4



4 teiliges Set:

- 1 Induktionskochplatte mit Regler (Ø 24 cm, 900 Watt)
- 1 Metallständer schwarz
- 1 Rahmen aus Eiche (wasserfest lackiert)
- 1 Edelstahlrahmen

4 pcs. set:

- 1 induction hotplate with controller (Ø 24 cm, 900 watt)
- 1 metal stand black
- 1 frame made of oak (water-resistant coated)
- 1 stainless steel frame

set de 4:

- 1 placa de inducción con regulador (Ø 24 cm, 900 vatios)
- 1 soporte de metal negro
- 1 caja de roble (con recubrimiento resistente al agua)
- 1 marco de acero inoxidable

set de 4:

- 1 plaque d'induction avec température réglable (Ø 24 cm, 900 watts)
- 1 support métallique noir
- 1 cadre en chêne (verni résistant à l'eau)
- 1 cadre en acier inox

	cm	↑ cm	€
12275	35,4 x 32,5	19	224,00



passendes Chafing Dish Set 12339
suitable chafing dish set 12339

Ersatzteile / replacement parts / piezas de repuesto / pièces de rechange

	cm	↑ cm		€
12276	35,4 x 32,5	8,5	Holzrahmen / wooden frame	72,00
12272	29,5 x 26,5	1	Edelstahlrahmen / stainless steel frame	22,00
12295	Ø 24	-	900 Watt Induktionskochplatte / induction plate	139,00
15506	35,4 x 32,5	17,6	Buffetständer schwarz / buffet stand black	22,80



Induktionsstation, 2-tlg. Set „VALO“

Induction station, 2-piece set
Estación de inducción, juego de 2 piezas
Station à induction, set de 2 pièces



Set, bestehend aus Induktionkochplatte 2000 Watt, inklusive Kabel-Fernbedienung, Leistung in Stufen regelbar, Rahmen aus Eichenholz (wasserfest lackiert)

set consists of induction hotplate 2000 Watt, cable remote control, power adjustable in steps, frame made of oak (waterproof lacquered)

set, compuesto por placa de inducción 2000 Watt, incluye mando a distancia por cable, potencia regulable en pasos, madera de roble (lacado impermeable)

set, composé d'une plaque de cuisson à induction 2000 watts, télécommande filaire incluse, puissance réglable par paliers, bois de chêne (vernis imperméable)

	cm	↑ cm		€
14050	39 x 39	10	2000 W	280,00



Einbau-Induktionskochplatte für Chafing Dish
 built-in induction plate for chafing dish
 placa de inducción para empotrar
 plaque à induction à encastrer



inkl. Kabel-Fernbedienung, energiesparend, Leistung in 5 Stufen regelbar
 incl. cable remote control, energy-saving, power adjustable in 5 steps
 incl. mando a distancia con cable, ahorro energético, potencia regulable en 5 pasos
 y compris télécommande filaire, économe en énergie, puissance réglable en 5 étapes

	cm	↑ cm		€
12285	35,5 x 35,5	6	2000 W	220,00

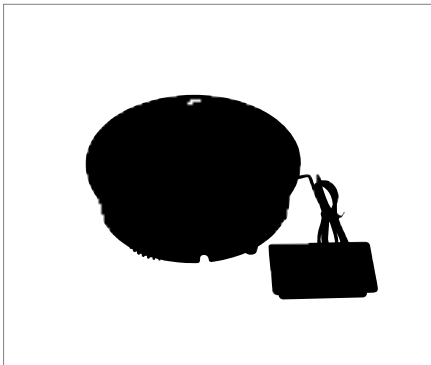

Induktionskochplatte für Chafing Dish
 induction plate for chafing dish
 placa de inducción para chafing dish
 plaque à induction pour chafing dish

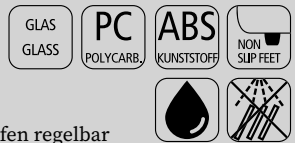

inkl. Kabel-Fernbedienung, energiesparend, Leistung in 5 Stufen regelbar
 incl. cable remote control, energy-saving, power adjustable in 5 steps
 incl. mando a distancia con cable, ahorro energético, potencia regulable en 5 pasos
 y compris télécommande filaire, économe en énergie, puissance réglable en 5 étapes

	Ø cm			€
12295	24		900 W	139,00



Metallrahmen für Induktionskochplatten
 frame for induction plate
 marco para placa de inducción
 cadre support inox pour plaque induction



			€
12291	für runde Chafer / for round chafing dish		18,30
12296	für Chafer GN 1/1 / for GN 1/1 chafing dish		19,40



600 Watt 12292

Elektro-Heizelement
 heating unit
 resistencia
 résistance



			€
12292	600 W / 230 V	for chafer covers are <u>closed</u> most of the time	150,00

mit einstellbarem Leistungsregler / adjustable heat control / abiertos con termostato /
 contrôle de la chaleur réglable

			€
12294	800 W / 230 V	for chafer covers are <u>open</u> most of the time	198,00



Heizplatte durch Spiralfeder an Wasserbad gedrückt
 Heating plate is pressed against the water bath by a spiral spring

Mobile Chafing Dish Heizung
 heating element
 resistencia
 résistance



für alle marktgängigen Chafing Dishes
 suitable for all current popular chafing dishes, with special spring
 para todos los chafing dish más corrientes
 pour la plupart des chafing dish les plus courants

	Ø cm	↑ cm		€
12299	14	9 - 11	500 W / 220 V	42,00

WARMERS



Wärmelampe mit 2 Infrarotlampen

thermal bridge
puente térmico
pont thermique



höhenverstellbar 58 - 77,5 cm, inklusive 2 Lampen, Kabellänge: 1,5 Meter

height ajustable from 58 to 77,5 cm, including 2 infrared lamps, cable length: 1,5 metres

regulable en altura de 58 a 77,5 cm, con 2 lámparas de infrarrojos, longitud del cable: 1,5 metros

réglable en hauteur de 58 à 77,5 cm, avec 2 lampes infrarouges, longueur du câble: 1,5 mètre

	cm	↑ cm	V	W	Farbe / Colour	€
12265	50 x 35	58 - 77,5	230	2 x 250	■	145,00

Ersatzbirne für Wärmelampe

infrared lamp / bulb
lámpara infrarrojos / bombilla
lampe infrarouge / ampoule

Fassung E27, Lichtfarbe: warmweiß

socket: E27, light colour: warm white

casquillo: E27, color de la luz: blanco cálido

douille: E27, couleur de lumière: blanc chaud

	W	fits to	€
12266	250	12265	10,00



Speisenwärmer

warmer
calienta platos
chauffe-plat



3-flammig / 3 lights / 3 velas / 3 bougies

	cm	↑ cm	€
35065	34 x 18	6	18,70



Speisenwärmer

warmer
calienta platos
chauffe-plat



2-flammig / 2 lights / 2 velas / 2 bougies

	cm	↑ cm	€
35343	34 x 13	6	14,20



Rolltophaube „SWISS“

rolltop-cover
campana rolltop
cloche rolltop



hochglanzpoliert, klappbar auf 90°, nachrüstbar für alle handelsüblichen Chafer
mirror polished finish, cover adjustable at 90°, usable for all commercial chafing dishes
pulido brillante, tapa ajustable 90°, apto para todos los chafings profesionales
poli brillant, ouverture réglable à 90°, apte pour tous les chafings professionnels

	cm	↑ cm	€
12310	55 x 34	19,5	94,00



Bain-Marie Topf

bain marie pot
olla baño Maria
marmite bain-marie



inkl. Deckel, mit Löffelaussparung
included cover, notched for spoon
incluye tapa con hueco para la cuchara
inclut le couvercle avec espace pour la louche

4,5 ltr.

	Ø cm	↑ cm	ltr.	€
12244	20	18	4,5	29,00

Deckel / cover / tapa / couvercle

11244				9,00
-------	--	--	--	------



Bain-Marie Deckel

cover for bain marie
tapa del baño maría
couvercle du bain-marie



	cm	€
12243	54 x 33,5	28,00



Wärme-Kies

granite chips
granulado térmico
gravier thermique



für Chafing Dishes, feine Körnung, hohe Wärmespeicherung, kein Verkleben,
ideal zum Warmhalten von Eiern

fine for chafing dishes and clean granite chippings, ideal for keeping eggs warm
gravilla de granito fina limpia, ideal para mantener los huevos calientes
gravier fin de granit, lavé, idéal pour maintenir les oeufs au chaud

	kg	€
81116	7	19,00



82274

Präsentationsmöglichkeit
presentation example

5 STARS



Töpfe aus emailiertem Gusseisen leiten nicht nur die Wärme gut, sondern können sie auch lange energieschonend speichern – ideal für den professionellen Einsatz am Buffet!

Cooking pots made of enamelled cast iron not only conduct heat well, but can also store it for a long time while conserving energy - ideal for professional use at the buffet!

Las ollas de hierro fundido esmaltado no sólo conducen bien el calor, sino que también pueden almacenarlo durante mucho tiempo conservando la energía: ¡ideales para un uso profesional en el buffet!

Les marmites en fonte émaillée ne conduisent pas seulement bien la chaleur, mais peuvent aussi la conserver longtemps en économisant de l'énergie - idéal pour une utilisation professionnelle au buffet!

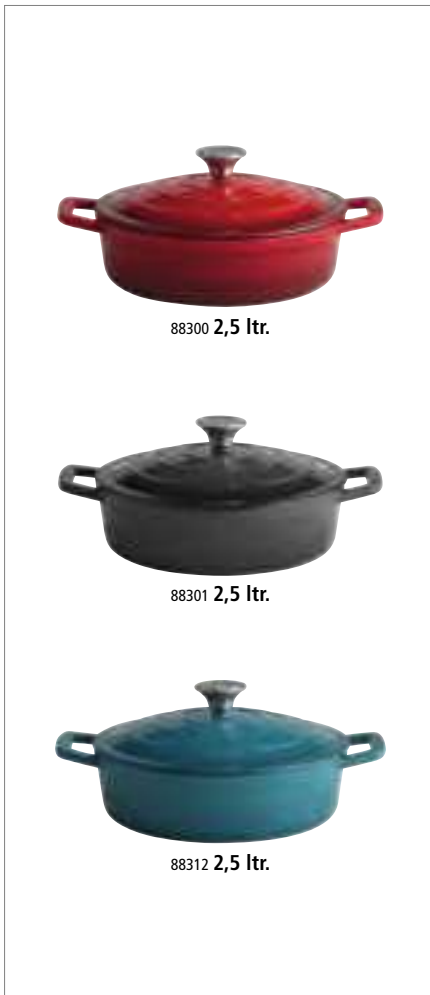

Bräter mit Deckel „5 STARS“ roaster with lid cacerola con tapa cocotte avec couvercle



	Ø cm	↑ cm	ltr.	Farbe / Colour	€
88300	25	7 / 13	2,5		59,00
88301	25	7 / 13	2,5		59,00
88312	25	7 / 13	2,5		59,00



inklusive Deckelhalter
including lid holder



88302 4 ltr.



88303 4 ltr.



88313 4 ltr.

Kochtopf mit Deckel „5 STARS“
 cooking pot with lid
 olla con tapa
 marmite avec couvercle



	Ø cm	↑ cm	ltr.	Farbe / Colour	€
88302	25	11,5 / 17,5	4		64,00
88303	25	11,5 / 17,5	4		64,00
88313	25	11,5 / 17,5	4		64,00



88302

inklusive Deckelhalter
 including lid holder



88304 3 ltr.



88305 3 ltr.



88314 3 ltr.

Bräter mit Deckel „5 STARS“
 roaster with lid
 cacerola con tapa
 cocotte avec couvercle



	Ø cm	↑ cm	ltr.	Farbe / Colour	€
88304	28	7 / 13,5	3		69,00
88305	28	7 / 13,5	3		69,00
88314	28	7 / 13,5	3		69,00



88304

inklusive Deckelhalter
 including lid holder



Kochtopf mit Deckel „5 STARS“
 cooking pot with lid
 olla con tapa
 marmite avec couvercle



	Ø cm	↑ cm	ltr.	Farbe / Colour	€
88306	28	13 / 20	6		74,00
88307	28	13 / 20	6		74,00
88315	28	13 / 20	6		74,00



inklusive Deckelhalter
 including lid holder



Bräter mit Deckel „5 STARS“
 roaster with lid
 cacerola con tapa
 cocotte avec couvercle



	cm	↑ cm	ltr.	Farbe / Colour	€
88308	33 x 25	11 / 17,5	5		79,00
88309	33 x 25	11 / 17,5	5		79,00
88316	33 x 25	11 / 17,5	5		79,00



inklusive Deckelhalter
 including lid holder



88310 3,5 ltr.

88311 3,5 ltr.

88317 3,5 ltr.

Auflaufform „5 STARS“
casserole dish
fuente para gratinar
plat à four



	cm	↑ cm	ltr.	Farbe / Colour	€
88310	33 x 24	6,5	3,5		54,00
88311	33 x 24	6,5	3,5		54,00
88317	33 x 24	6,5	3,5		54,00



Deckelhalter, 2er Set
lid holder, 2 pcs.



soporte para tapa, set de 2
support de couvercle, set de 2

mit Antirutschbeschichtung, für alle Töpfe mit Deckel einsetzbar, hitzebeständig
with non-slip coating, suitable for all pots with lids, heat-resistant

revestimiento antideslizante, apto para todas las ollas con tapa, resistente al calor
avec revêtement antidérapant, adapté à toutes les casseroles avec couvercle, résistant à la chaleur

	cm	↑ cm	Farbe / Colour	pcs.	€ / set
88320	10,5 x 8,5	3,5		2	10,00



88308 5 ltr.

88315 6 ltr.

88310 3,5 ltr.



88303 4 ltr.

88305 3 ltr.

88312 2,5 ltr.

SAMOVARS

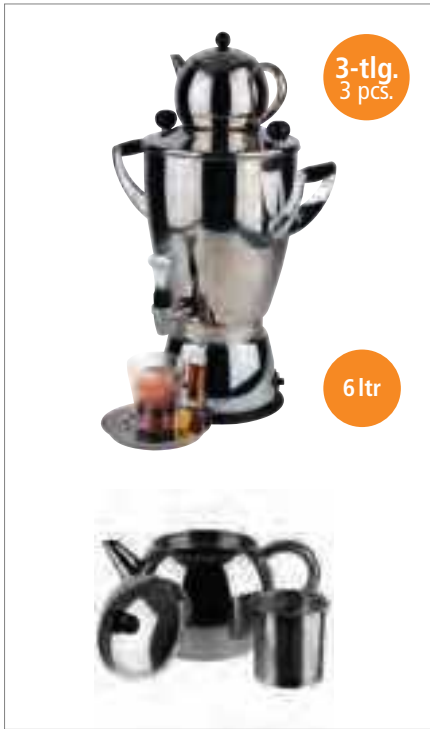

3-tlg.
3 pcs.

6 ltr

Samovar

samovar
samovar
samovar



3-teiliges Set:

- 1 Samovar, 230V, 50/60Hz, 1.800W (6 Liter)
- 1 Teekanne (1,1 Liter)
- 1 Tropfenschale

3 pcs. set:

- 1 samovar, 230V, 50/60Hz, 1.800W (6 ltr.)
- 1 teapot (1,1 ltr.)
- 1 drip tray

set de 3:

- 1 samovar, 230V, 50/60Hz, 1.800W (6 L.)
- 1 tetera (1,1 L.)
- 1 bandeja recogegotas

set de 3:

- 1 samovar, 230V, 50/60Hz, 1.800W (6 L.)
- 1 théière (1,1 L.)
- 1 bac ramasse-gouttes

	cm	↑ cm	ltr.	€
12315	35 x 21	58	6	540,00



3-tlg.
3 pcs.

12 ltr

Samovar

samovar
samovar
samovar



3-teiliges Set:

- 1 Samovar, 230V, 50/60Hz, 1.800W (12 Liter)
- 1 Teekanne (1,3 Liter)
- 1 Tropfenschale

3 pcs. set:

- 1 samovar, 230V, 50/60Hz, 1.800W (12 ltr.)
- 1 teapot (1,3 ltr.)
- 1 drip tray

set de 3:

- 1 samovar, 230V, 50/60Hz, 1.800W (12 L.)
- 1 tetera (1,3 L.)
- 1 bandeja recogegotas

set de 3:

- 1 samovar, 230V, 50/60Hz, 1.800W (12 L.)
- 1 théière (1,3 L.)
- 1 bac ramasse-gouttes

	cm	↑ cm	ltr.	€
12316	42 x 26	75	12	890,00



NEW

Tasse „TEATIME“

mug
taza
tasse



transparent mattiert, ideal in sensiblen Bereichen wie Pool, Spa, Beach und Wellness einzusetzen
transparent frosted, ideal to be used at pool, spa, beach and wellness areas
transparente esmerilado, ideal para el uso en áreas como piscina, spa, playa y bienestar
transparent mat, idéal pour une utilisation dans des zones comme la piscine, le spa, la plage et le bien-être

	Ø cm	↑ cm	ltr.	Farbe / Colour	VE / unit	€ / pc.
66940	8,5	9	0,25	transparent	24	3,90





10,5 ltr.

Kaffeedispenser „HAPPY HOUR“

coffee dispenser
dispensador de café
distributeur de café



hochglanzpoliert, für warme Getränke, stabil und standfest, inkl. 1 Brennpastenbehälter
mirror polished finish, for warm drinks, solid and stable, incl. 1 burner holder
acabado pulido brillante para bebidas calientes, sólido y estable, incluye un calentador
brillant, pour boissons chaudes, avec 1 brûleur, robuste et stable

	cm	↑ cm	ltr.	€
11672	31 x 33,5	54,5	10,5	210,00

Hahn / tap / grifo / robinet

	€
11671	27,00



Elektro-Heizelement

heating unit
resistencia
résistance



für Kaffeedispenser (Nr. 11672), 500 W, 220 V, einfach in das Gestell des Dispensers legen
for coffee dispenser (no. 11672), 500 W, 220 V, insert into the frame of the dispenser
para dispensador de café (11672), 500 W, 220V, directamente en el pie del dispensador
pour distributeur à café (11672), 500 W, 220 V, directement dans le support

	€
12287	99,00



16003

16004

16005

Kaffeetasse „SNUG“

coffee cup
taza de café
tasse à café



Porzellan, Griff: 2 cm / porcelain, handle: 2 cm / porcelana, asa: 2 cm / porcelaine, poignée: 2 cm

	Ø cm	↑ cm	ltr.	Farbe / Colour	VE / unit	€ / pc.
16003	9,5	6	0,2		6	4,30
16004	9,5	6	0,2		6	4,30
16005	9,5	6	0,2		6	4,30



16012

16013

16014

Kaffeuntertasse „SNUG“

coffee saucer
platillo de café
soucoupe à café



Porzellan / porcelain / porcelana / porcelaine

	Ø cm	↑ cm	Farbe / Colour	VE / unit	€ / pc.
16012	14,5	2,5		6	3,40
16013	14,5	2,5		6	3,40
16014	14,5	2,5		6	3,40

GN-CONTAINERS

GN-Behälter Größen nach EN 631

Alle Behälter sind aus rostfreiem Chrom-Nickel-Edelstahl mit elektrolytisch polierter (seidenmatt) Oberfläche und somit perfekt geeignet für den professionellen Einsatz.

GN-container according to EN 631

All pans are made of chrome/nickel stainless steel with a surface polished by electrolysis (satin-matt) and therefore highly suitable for professional operation.

De conformidad con la norma europea EN 631.

Todos los contenedores están fabricados en acero inoxidable cromado/niquelado con su superficie (satinada) pulida por electrolisis lo que la hace altamente apropiado para el uso profesional.

Bacs GN- Conforme à la norme EN 631

Tous les bacs sont fabriqués en inox/chrome/nickel, surface polie électrolythique (satiné). Approprié pour usage professionnel.

Vorteile der rund geprägten U-Ecken:

- erhöhte Stabilität durch verstärktes Profil
- zielgerechtes und sauberes Ausgießen
- genaue Positionierung der GN-Behälter
- superleichtes Stapeln und Entstapeln
- kein Verklemmen der GN-Behälter
- hohe Stoßfestigkeit durch robuste Konstruktion
- ansprechendes Design und stilvoller Blickfang

Advantages of the round-shaped U-Corners:

- increased stability due to the unique construction
- clean ladling and pouring
- exact positioning of the containers
- improved shock-resistance
- appealing design
- no seize of the containers

Ventajas de las esquinas en U:

Perfil reforzado que confiere mayor rigidez y resistencia a la cubeta, diseño para verter fácil y limpiamente, fáciles de apilar y desapilar sin que se claven entre sí, construcción más robusta y resistente a los golpes mecánicos, diseño elegante.

Avantages et fonctionnalité des angles en U:

Profil renforcé pour une meilleure consistance et rigidité du récipient, design qui facilite un versage propre et aisé, permet un empilage et désempilage faciles sans que les bacs restent coincés, meilleure résistance aux chocs mécaniques, seign élégant.

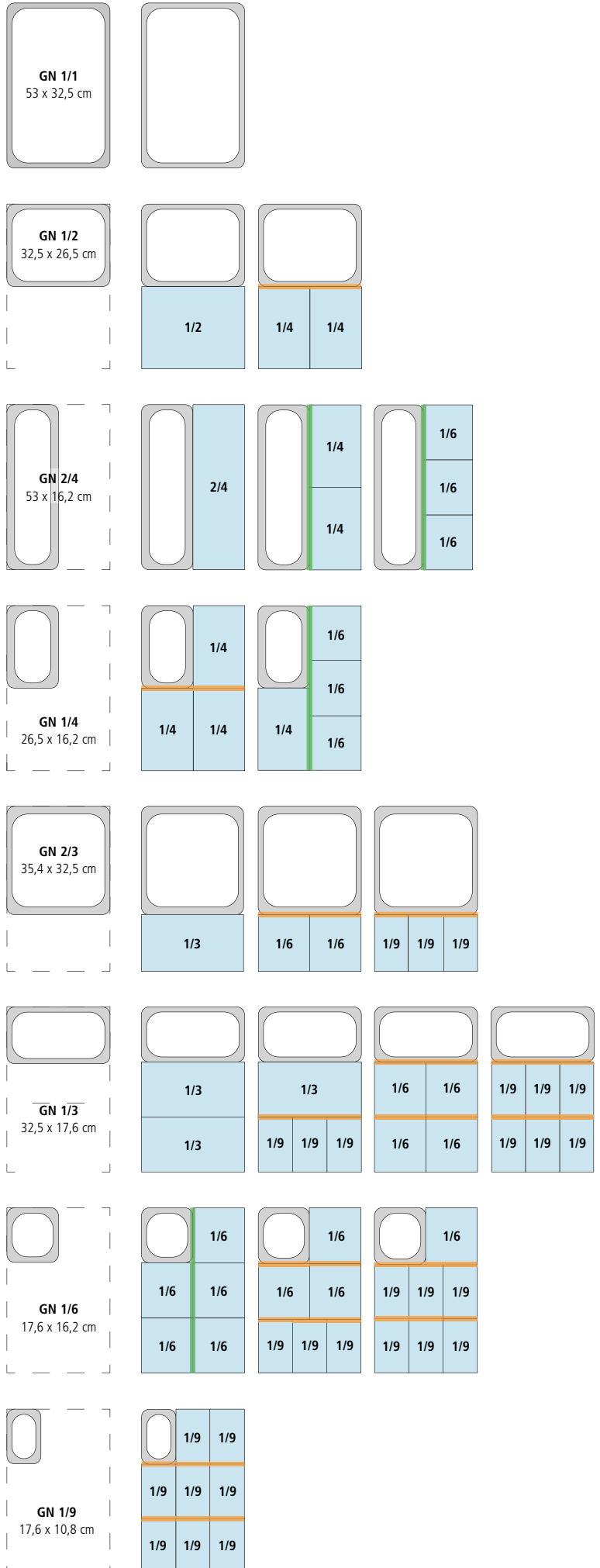

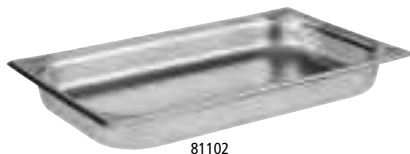

81102



81202

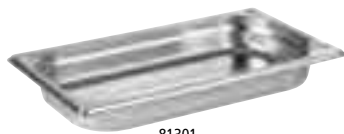

81301



81402



81604



81504



81702

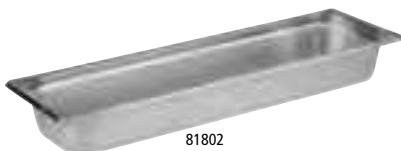

81802

GN-Behälter

GN-container

GN cubetas

GN bacs



	GN	↓ mm	ltr.	cm	€
81000	2/1	20	5,0	53,0 x 65,0	38,80
81095	1/1	10	1,25	53,0 x 32,5	13,90
81100	1/1	20	2,5	53,0 x 32,5	15,60
81101	1/1	40	5,0	53,0 x 32,5	17,50
81109	1/1	55	6,5	53,0 x 32,5	18,30
81102	1/1	65	9,0	53,0 x 32,5	18,60
81104	1/1	100	13,25	53,0 x 32,5	22,90
81106	1/1	150	20,0	53,0 x 32,5	34,50
81108	1/1	200	25,0	53,0 x 32,5	41,80

	GN	↓ mm	ltr.	cm	€
81200	1/2	20	1,0	32,5 x 26,5	6,40
81201	1/2	40	2,0	32,5 x 26,5	9,60
81209	1/2	55	2,8	32,5 x 26,5	9,90
81202	1/2	65	4,0	32,5 x 26,5	10,20
81204	1/2	100	6,0	32,5 x 26,5	13,80
81206	1/2	150	8,75	32,5 x 26,5	21,70
81208	1/2	200	11,65	32,5 x 26,5	28,00

	GN	↓ mm	ltr.	cm	€
81300	1/3	20	0,75	32,5 x 17,6	5,00
81301	1/3	40	1,5	32,5 x 17,6	6,20
81302	1/3	65	2,5	32,5 x 17,6	7,70
81304	1/3	100	4,0	32,5 x 17,6	10,90
81306	1/3	150	5,7	32,5 x 17,6	14,80
81308	1/3	200	7,0	32,5 x 17,6	19,60

	GN	↓ mm	ltr.	cm	€
81400	1/4	20	0,5	26,5 x 16,2	5,20
81401	1/4	40	1,0	26,5 x 16,2	5,90
81402	1/4	65	1,8	26,5 x 16,2	7,00
81404	1/4	100	2,8	26,5 x 16,2	9,30
81406	1/4	150	4,0	26,5 x 16,2	14,30
81408	1/4	200	5,5	26,5 x 16,2	17,80

	GN	↓ mm	ltr.	cm	€
81602	1/6	65	1,0	17,6 x 16,2	5,10
81604	1/6	100	1,6	17,6 x 16,2	7,00
81606	1/6	150	2,4	17,6 x 16,2	11,30
81608	1/6	200	3,0	17,6 x 16,2	13,90

	GN	↓ mm	ltr.	cm	€
81502	1/9	65	0,6	17,6 x 10,8	3,80
81504	1/9	100	1,0	17,6 x 10,8	5,70
81506	1/9	150	1,5	17,6 x 10,8	8,10

	GN	↓ mm	ltr.	cm	€
81700	2/3	20	1,5	35,4 x 32,5	11,20
81701	2/3	40	3,0	35,4 x 32,5	14,80
81702	2/3	65	5,5	35,4 x 32,5	17,10
81704	2/3	100	8,4	35,4 x 32,5	22,60
81706	2/3	150	12,5	35,4 x 32,5	32,60
81707	2/3	200	18,0	35,4 x 32,5	35,20

	GN	↓ mm	ltr.	cm	€
81800	2/4	20	1,2	53,0 x 16,2	9,40
81801	2/4	40	2,4	53,0 x 16,2	12,30
81802	2/4	65	3,6	53,0 x 16,2	14,40
81804	2/4	100	5,6	53,0 x 16,2	20,10
81806	2/4	150	8,7	53,0 x 16,2	23,40

GN-CONTAINERS



perforierte GN-Behälter

perforated GN-container
cubetas GN perforadas
bacs GN perforés



	GN	↓ mm	cm	€
81911	1/1	40	53,0 x 32,5	18,30
81907	1/1	65	53,0 x 32,5	18,60
81908	1/1	100	53,0 x 32,5	22,90
81909	1/1	150	53,0 x 32,5	34,50
81910	1/1	200	53,0 x 32,5	41,80
81901	1/2	65	32,5 x 26,5	10,20
81902	1/2	100	32,5 x 26,5	13,80
81903	1/2	150	32,5 x 26,5	21,70
81904	1/2	200	32,5 x 26,5	28,00
81905	2/3	65	35,4 x 32,5	17,10
81906	2/3	100	35,4 x 32,5	22,60



GN 1/6 Abklopfbehälter

GN 1/6 tapping container
GN 1/6 contenedor knock-out
GN 1/6 bac knock-out



mit Abklopfstange aus Silikon, rutschfester Boden
with silicone tapping rod, non-slip bottom
con varilla de silicona, base antideslizante
avec tige en silicone, fond antidérapant

	cm	↑ cm	ltr.	€
81611	17,6 x 16,2	15	2,4	19,00



rutschfester Boden
non-slip bottom



GN-Behälter Set, 4 teilig

GN-container, 4 pcs.
GN cubetas, set de 4
GN bacs, set de 4



bestehend aus: Edelstahlbehälter 1x GN 1/2 + 2x GN 1/4 + 1 Adapter
consisting of: stainless steel containers 1x GN 1/2 + 2x GN 1/4 + adapter
consiste en: cubetas de acero inoxidable 1x GN 1/2 + 2x GN 1/4 + adaptador
composé de: bacs en acier inox 1x GN 1/2 + 2x GN 1/4 + adaptateur

	GN	↓ mm	ltr.	cm	pcs	€ / set
81850	1/2	65	4,0	32,5 x 26,5	1	26,60
	1/4	65	1,8	26,40 x 16,2	2	
	Adapter			31,5	1	

**GN-Deckel**

GN-lid
GN tapa
GN couvercle

**ohne Löffelaussparung**

without notched edge for spoons
sin agujero para cucharón
sans espace pour louche

	GN	cm	€
81195	1/1	53,0 x 32,5	14,40
81295	1/2	32,5 x 26,5	7,40
81395	1/3	32,5 x 17,6	5,60
81495	1/4	26,5 x 16,2	5,20
81695	1/6	17,6 x 16,2	3,10
81591	1/9	17,6 x 10,8	3,20
81795	2/3	35,4 x 32,5	15,80
81895	2/4	53,0 x 16,2	11,40

**GN-Deckel**

GN-lid
GN tapa
GN couvercle

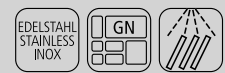
**mit Löffelaussparung**

with notched edge for spoons
con agujero para cucharón
avec espace pour louche

	GN	cm	€
81191	1/1	53,0 x 32,5	15,60
81292	1/2	32,5 x 26,5	8,20
81391	1/3	32,5 x 17,6	6,30
81492	1/4	26,5 x 16,2	5,90
81692	1/6	17,6 x 16,2	3,50
81595	1/9	17,6 x 10,8	3,30
81791	2/3	35,4 x 32,5	17,10
81891	2/4	53,0 x 16,2	12,70



Die Löffelaussparung mit Prägung verhindert das Zurückfließen von Flüssigkeit auf dem Deckel in den Behälter.

The notch for spoon with embossing prevents liquid on the lid from flowing back into the container.

GN-CONTAINERS



GN Transport-Steck-Deckel

GN-lid with silicone seal
GN tapa hermética con junta
GN couvercle hermétique avec joint



Silikondichtung, Griffmulde und Loch gegen Unterdruck, schwappsicherer Transport nicht für Kombidämpfer geeignet

silicone joint, flat handle, vent to compensate, slosh-proof transport, for pressure, not usable for steam oven
junta de silicona, asa empotrada, válvula para compensar, transporte sin salpicaduras, la presión, no se puede utilizar en hornos de vapor
joint silicone, anse encastrée, valve pour compenser la pression, transport sans éclaboussures, ne convient pas pour les étuves combinées

	GN	cm	€
80023	1/1	53,0 x 32,5	38,60
80024	1/2	32,5 x 26,5	24,00
80025	1/3	32,5 x 17,6	21,00
80026	1/4	26,5 x 16,2	18,00
80027	1/6	17,6 x 16,2	14,80
80028	2/4	53,0 x 16,2	34,80
80029	2/3	35,4 x 32,5	37,40

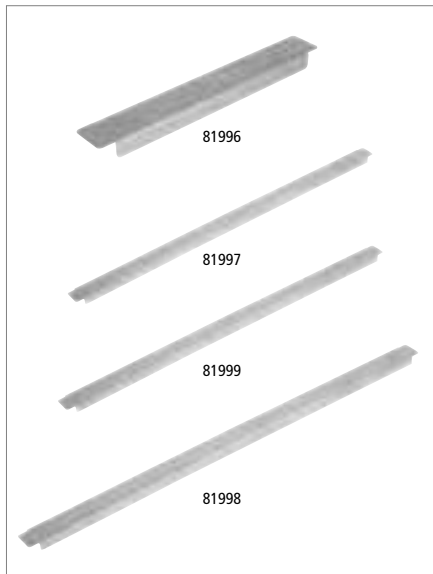

Adapter / Zwischensteg

adapter
adaptador
adaptateur



ermöglicht stabilen Halt von GN-Behältern im CD, rostfreier Chrom-Nickel-Edelstahl

for fixing GN pans, chrome / nickel stainless steel
para sujetar las cubetas GN, acero inox
support stable pour les bacs GN

	cm	€
81996	15,9 längs bei GN 1/4 / lengthwise GN 1/4 longitud GN 1/4 / GN 1/4 dans la longueur	1,80
81997	17,6 längs bei GN 1/9 / lengthwise GN 1/9 longitud GN 1/9 / GN 1/9 dans la longueur	2,00
81999	32,5 quer bei GN 1/2 / crosswise GN 1/2 de ancho GN 1/2 / GN 1/2 dans la largeur	3,20
81998	52,5 längs bei GN 1/1 / lengthwise GN 1/1 longitud GN 1/1 / GN 1/1 dans la longueur	5,50



GN Abtropfgitter

GN-drainer
GN escurridor
GN égouttoir



Abtropfgitter aus Edelstahl für Gastronorm Behälter, passend für GN 1/1 und GN 1/2

stainless steel GN drainer for GN 1/1 + GN 1/2
escurridor GN de acero inoxidable para GN 1/1 + GN 1/2
égouttoir GN en acier inoxydable pour GN 1/1 + GN 1/2

	GN	cm	↑ cm	€
81117	1/1	45 x 25	1,5	22,00
81118	1/2	25 x 19	1,5	16,00



GN-Behälter aus Polypropylen

GN-container polypropylene
GN cubetas polipropileno
GN bacs polypropilène



transparent: Skalierung in Liter, robust und formstabil

transparent: liter scale, solid quality

transparente: graduación en litros, alta calidad

transparent: graduation en litres, haute-qualité

	GN	↓ mm	ltr.	cm	€
82104	1/1	65	8,5	53 x 32,5	10,20
82106	1/1	100	13,0	53 x 32,5	11,70
82108	1/1	150	19,5	53 x 32,5	13,30
82110	1/1	200	26,0	53 x 32,5	16,30
	GN	↓ mm	ltr.	cm	€
82112	1/2	65	3,9	32,5 x 26,5	5,50
82114	1/2	100	5,9	32,5 x 26,5	6,30
82116	1/2	150	8,9	32,5 x 26,5	7,80
82117	1/2	200	11,8	32,5 x 26,5	9,00
	GN	↓ mm	ltr.	cm	€
82118	1/3	65	2,4	32,5 x 17,5	4,60
82120	1/3	100	3,6	32,5 x 17,5	5,30
82122	1/3	150	5,3	32,5 x 17,6	6,90
82123	1/3	200	7,0	32,5 x 17,6	7,90
	GN	↓ mm	ltr.	cm	€
82128	1/4	65	1,7	26,5 x 16,2	3,80
82130	1/4	100	2,5	26,5 x 16,2	4,40
82132	1/4	150	3,7	26,5 x 16,2	5,80
82134	1/4	200	4,8	26,5 x 16,2	9,20
	GN	↓ mm	ltr.	cm	€
82136	1/6	65	1,0	17,6 x 16,2	3,20
82138	1/6	100	1,5	17,6 x 16,2	3,70
82140	1/6	150	2,2	17,6 x 16,2	4,30
82142	1/6	200	2,8	17,6 x 16,2	7,80
	GN	↓ mm	ltr.	cm	€
82150	1/9	65	0,6	17,6 x 10,8	3,00
82151	1/9	100	1,0	17,6 x 10,8	3,20



stapelbar
stackable



Skalierung
scaling



GN-Deckel

GN-lid
GN tapa
GN couvercle



	GN	↑ cm	cm	€
82101	1/1	1,5	53,0 x 32,5	5,70
82113	1/2	1,5	32,5 x 26,5	3,40
82119	1/3	1,5	32,5 x 17,6	2,90
82129	1/4	1,5	26,5 x 16,2	2,80
82137	1/6	1,5	17,6 x 16,2	2,70
82159	1/9	1,5	17,6 x 10,8	2,60

BLACK GN CONTAINERS



82065 GN 1/2 | 100 mm



82069 GN 1/3 | 100 mm



82073 GN 1/4 | 100 mm



82077 GN 1/6 | 100 mm



82081 GN 1/9 | 100 mm

GN-Behälter aus Polycarbonat

GN-container polycarbonate

GN cubeta policarbonato

GN bac polycarbonate

schwarz: Skalierung in Liter, robust und formstabil

black: liter scale, solid quality

negro: graduación en litros, alta calidad

noir : graduation en litres, haute-qualité



	GN	↓ mm	ltr.	cm	€
82064	1/2	65	3,9	32,5 x 26,5	9,00
82065	1/2	100	5,9	32,5 x 26,5	11,00
82066	1/2	150	8,9	32,5 x 26,5	13,50
82068	1/3	65	2,4	32,5 x 17,6	7,60
82069	1/3	100	3,6	32,5 x 17,6	9,00
82070	1/3	150	5,3	32,5 x 17,6	11,00
82072	1/4	65	1,7	26,5 x 16,2	5,90
82073	1/4	100	2,5	26,5 x 16,2	7,00
82074	1/4	150	3,7	26,5 x 16,2	8,30
82076	1/6	65	1,0	17,6 x 16,2	5,10
82077	1/6	100	1,5	17,6 x 16,2	5,50
82078	1/6	150	2,2	17,6 x 16,2	6,70
82081	1/9	100	1,0	17,6 x 10,8	4,30



passende Deckel, Seite 455
suitable lid, page 455



stapelbar
stackable



GN-Behälter aus Polycarbonat

GN-container polycarbonate

GN cubeta polycarbonato

GN bac polycarbonate



	GN	↓ mm	ltr.	cm	€
82004	1/1	65	8,5	53,0 x 32,5	17,50
82006	1/1	100	13,0	53,0 x 32,5	20,00
82008	1/1	150	19,5	53,0 x 32,5	25,40
82010	1/1	200	26,0	53,0 x 32,5	33,20
	GN	↓ mm	ltr.	cm	€
82012	1/2	65	3,9	32,5 x 26,5	8,60
82014	1/2	100	5,9	32,5 x 26,5	10,40
82016	1/2	150	8,9	32,5 x 26,5	12,80
82017	1/2	200	11,8	32,5 x 26,5	17,10
	GN	↓ mm	ltr.	cm	€
82018	1/3	65	2,4	32,5 x 17,6	7,20
82020	1/3	100	3,6	32,5 x 17,6	8,60
82022	1/3	150	5,3	32,5 x 17,6	10,40
82023	1/3	200	7,0	32,5 x 17,6	12,80
	GN	↓ mm	ltr.	cm	€
82028	1/4	65	1,7	26,5 x 16,2	5,60
82030	1/4	100	2,5	26,5 x 16,2	6,70
82032	1/4	150	3,7	26,5 x 16,2	10,60
82034	1/4	200	4,8	26,5 x 16,2	13,10
	GN	↓ mm	ltr.	cm	€
82036	1/6	65	1,0	17,6 x 16,2	4,90
82038	1/6	100	1,5	17,6 x 16,2	5,20
82040	1/6	150	2,2	17,6 x 16,2	6,30
82042	1/6	200	2,8	17,6 x 16,2	9,00
	GN	↓ mm	ltr.	cm	€
82050	1/9	65	0,6	17,6 x 10,8	3,50
82051	1/9	100	1,0	17,6 x 10,8	4,00



GN-Deckel

GN-lid

GN tapa

GN couvercle



	GN	↑ cm	cm	€
82001	1/1	2,5	53,0 x 32,5	11,60
82013	1/2	2,5	32,5 x 26,5	6,70
82019	1/3	2,5	32,5 x 17,6	5,30
82029	1/4	2,5	26,5 x 16,2	4,30
82037	1/6	2,5	17,6 x 16,2	3,30
82059	1/9	2,5	17,6 x 10,8	3,00

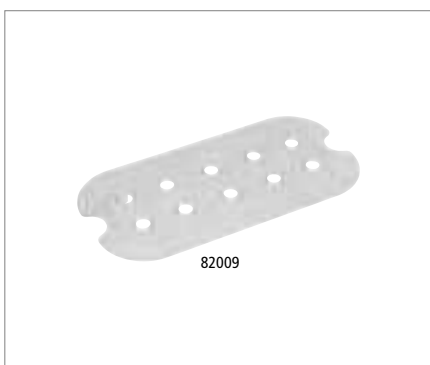

GN Abtropfgitter

GN drainer

GN escurridor

GN égouttoir



	für GN	↑ cm	cm	€
82003	1/1	2	47,3 x 26,8	8,80
82005	1/2	2	26,8 x 20,8	4,90
82007	1/3	2	26,8 x 11,8	3,80
82009	1/4	2	20,6 x 10,8	3,00
82011	1/6	2	11,7 x 10,4	2,60



PORCELAIN GN CONTAINERS



GN-Behälter
GN-container
GN cubetas
GN bac



	GN	↓ mm	ltr.	cm	€
82100	1/1	60	7,1	53,0 x 32,5	69,00
82200	1/2	60	3,4	32,5 x 26,5	31,00
82300	1/3	60	2,0	32,5 x 17,6	25,60
82306	2/3	60	4,6	35,4 x 32,5	46,00
82301	2/4	60	3,0	53,0 x 16,2	43,00



GN-Behälter
GN-container
GN cubeta
GN bac



	GN	↓ mm	ltr.	cm	Farbe / colour	€
82270	1/1	60	7,1	53,0 x 32,5		73,00
82271	1/1	60	7,1	53,0 x 32,5		73,00
82272	1/1	60	7,1	53,0 x 32,5		73,00
82273	1/1	60	7,1	53,0 x 32,5		73,00
82274	1/2	60	3,4	32,5 x 26,5		39,00
82275	1/2	60	3,4	32,5 x 26,5		39,00
82276	1/2	60	3,4	32,5 x 26,5		39,00
82277	1/2	60	3,4	32,5 x 26,5		39,00
82278	1/3	60	2,0	32,5 x 17,6		31,00
82279	1/3	60	2,0	32,5 x 17,6		31,00
82280	1/3	60	2,0	32,5 x 17,6		31,00
82281	1/3	60	2,0	32,5 x 17,6		31,00



GN Tablett „FRAMES“

GN tray
GN bandeja
GN plateau



	GN	↑ cm	cm	€
82355	1/1	2	53,0 x 32,5	46,00
82356	1/2	2	32,5 x 26,5	26,00
82357	1/3	2	32,5 x 17,6	22,00



Backblech

baking sheet
bandeja pastelera
plaque à pâtisserie



gelocht Ø 3 mm, Materialstärke 1,5 mm, Silikon beschichtet, temperaturbeständig bis 240°C
perforated Ø 3 mm, coated with silicon, heat resistant up to 240°C
aluminio con revestimiento de silicona perforada, resistente hasta 240°
aluminium avec revêtement silicone, perforée, température maxi 240°

	GN	cm	€
88285	1/1	53 x 32,5	38,00

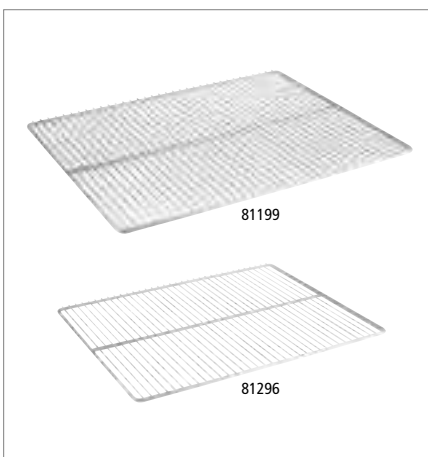

GN Roste

GN grid
GN rejilla
GN grille



elektrolytisch poliert, Drahtstärke 3 mm, Rahmendraht 6 mm, extra schwere Qualität
electro-polished, wire thickness 3 mm, frame wire 6 mm, extra heavy quality
inox pulido electrolítico, grosor alambre 3 mm, grosor marco 6 mm, calidad reforzada
inox poli électrolytique, fil 3 mm, cadre 6 mm, qualité renforcée

	GN	cm	€
81199	2/1	65,0 x 53,0	43,00
81198	1/1	53,0 x 32,5	20,40
81796	2/3	32,5 x 35,4	13,80
81296	1/2	32,5 x 26,5	11,20



GN 1/3 Bestecksammler

GN 1/3 container
GN 1/3 cubeta
GN 1/3 bac



mit 2 Haken zum Einhängen an Servier- oder Transportwagen
container with 2 hooks, to hang on trolleys for cutlery
cubeta con 2 ganchos para cubiertos, a colgar del carro
bac à couverts avec 2 crochets, à accrocher au chariot

	GN	↓ mm	cm	€
11978	1/3	150	32,5 x 17,5	23,00

GN-CONTAINERS



GN 2/4

GN 1/1

GN 1/2

GN 1/4

GN 1/6

GN-Behälter „ECOLINE“

GN container

GN cubeta

GN bac

mit Stapelnocke

with notching edge

con borde marcado para el apilado

avec rebord pour l'empilage



	GN	↓ mm	ltr.	cm	Farbe / Colour	€
83759	1/1	65	7,10	53,0 x 32,5		32,60
83755	2/4	65	3,00	53,0 x 16,2		22,00
83757	1/2	65	3,40	32,5 x 26,5		18,60
83753	1/3	65	2,00	32,5 x 17,6		16,00
83751	1/4	65	1,35	26,5 x 16,2		14,20
83749	1/6	65	0,80	17,6 x 16,2		11,20

	GN	↓ mm	ltr.	cm	Farbe / Colour	€
83758	1/1	65	7,10	53,0 x 32,5		32,60
83754	2/4	65	3,00	53,0 x 16,2		22,00
83756	1/2	65	3,40	32,5 x 26,5		18,60
83752	1/3	65	2,00	32,5 x 17,6		16,00
83750	1/4	65	1,35	26,5 x 16,2		14,20
83748	1/6	65	0,80	17,6 x 16,2		11,20

	GN	↓ mm	ltr.	cm	Farbe / Colour	€
84300	1/1	100	10,6	53,0 x 32,5		38,00
84302	2/4	100	4,3	53,0 x 16,2		27,40
84301	1/2	100	4,7	32,5 x 26,5		22,60
84303	1/3	100	2,7	32,5 x 17,6		18,40
84304	1/4	100	1,9	26,5 x 16,2		16,00
84305	1/6	100	1,0	17,6 x 16,2		12,20

	GN	↓ mm	ltr.	cm	Farbe / Colour	€
84306	1/1	100	10,6	53,0 x 32,5		38,00
84308	2/4	100	4,3	53,0 x 16,2		27,40
84307	1/2	100	4,7	32,5 x 26,5		22,60
84309	1/3	100	2,7	32,5 x 17,6		18,40
84310	1/4	100	1,9	26,5 x 16,2		16,00
84311	1/6	100	1,0	17,6 x 16,2		12,20



GN-Deckel

GN-lid

GN tapa

GN couvercle



	GN	cm	€
82001	1/1	53,0 x 32,5	11,60
82013	1/2	32,5 x 26,5	6,70
82019	1/3	32,5 x 17,6	5,30
82029	1/4	26,5 x 16,2	4,30
82037	1/6	17,6 x 16,2	3,30



GN Behälter „FRIENDLY“

GN pan
GN cubeta
GN bac

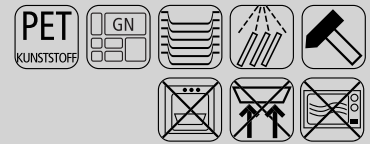

	cm	↑ cm	ltr.	Farbe / Colour	GN	€
79030	53 x 32,5	6,5	7,1	White	1/1	24,00
79031	53 x 32,5	6,5	7,1	Black	1/1	24,00
79032	32,5 x 26,5	6,5	3,4	White	1/2	14,90
79033	32,5 x 26,5	6,5	3,4	Black	1/2	14,90
79034	32,5 x 17,6	6,5	2	White	1/3	12,80
79035	32,5 x 17,6	6,5	2	Black	1/3	12,80
79036	32,5 x 17,6	10	2,7	White	1/3	14,90
79037	32,5 x 17,6	10	2,7	Black	1/3	14,90



GN Tablett „FRIENDLY“

GN tray
GN bandeja
GN plateau



	cm	↑ cm	Farbe / Colour	GN	€
79006	32,5 x 26,5	3	White	1/2	15,80
79007	32,5 x 26,5	3	Black	1/2	15,80

SERVING TROLLEYS



Servier- / Transportwagen „READY“

serving trolley
carro de servicio
chariot de service



Aluminiumrahmen, 3 Böden, Abstand zwischen den Böden 31 cm, mit 4 Lenkrollen, alle mit Feststellern, Tragfähigkeit: 50 kg je Boden, 150 kg insgesamt, demontiert, einfache Montage (Lieferung ohne Container und Dekoration)

frame aluminium, 3 shelves, distance between shelves 31 cm, 4 swivel wheels, all equipped with brakes, max. load per shelf 50 kg, 150 kg total, demounted, easy to mount (delivery without containers and decoration)

marco de aluminio, 3 pisos, distancia entre cada piso 31 cm, 4 ruedas giratorias, todas con freno, capacidad de carga: 50 kg por piso, 150 kg en total, desmontado, montaje sencillo (se entrega sin recipiente ni decoración)

cadre en aluminium, 3 étages, distance entre les niveaux 31 cm, 4 roues pivotantes, toutes avec freins, capacité de charge: 50 kg par niveau, 150 kg au total, livré démonté, montage facile (livré sans récipients ni décoration)

	cm	↑ cm	Farbe / Colour		€
11944 <small>NEW</small>	108 x 50	96		black	150,00
11945	108 x 50	96		blue-grey	150,00

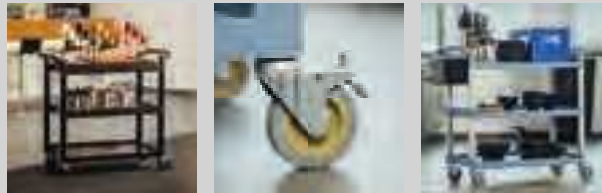

Container zum Einhängen, passend zu no. 11944 & 11945

container to hang up, suitable for no. 11944 & 11945
recipiente para colgar, adecuado para no. 11944 & 11945
récipient à suspendre, convient aux no. 11944 & 11945



	cm	↑ cm	ltr.	Farbe / Colour		€
11946	33 x 23	56,5	42		black	35,00
11947	33 x 23	17,5	13		black	18,00

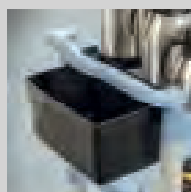

**Servier- / Transportwagen „STEADY“**

service trolley
carro de servicio
chariot de service



mit 3 Borden, Bordmaße 83 x 51 cm, Abstand zwischen den Borden 26 cm, Tragfähigkeit 120 kg, 4 Lenkrollen, davon 2 feststellbar, Lieferung demontiert, einfache Montage

with 3 trays, trays 83 x 51 cm, size between the trays 26 cm, total load capacity 120 kg, 4 wheels with 2 brakes, unassembled, simple assembly

con 3 bandejas inox mate, 83 x 51 cm, la medida entre bandejas 26 cm, capacidad total 120 kg, 4 ruedas con 2 frenos, construcción robusta, montaje fácil

3 niveaux, 83x51 cm chacun, distance entre niveaux 26 cm, capacité maxi 120 kg au total, 4 roues dont 2 avec frein, construction robuste, montage facile

	cm	↑ cm	€
11979	91 x 59	93	165,00

**Servier- / Transportwagen „GO“**

service trolley
carro de servicio
chariot de service



mit 2 Borden, Bordmaße 83 x 51 cm, Abstand zwischen den Borden 56 cm, Tragfähigkeit 80 kg, 4 Lenkrollen, davon 2 feststellbar, Lieferung demontiert, einfache Montage

with 2 trays, trays 83 x 51 cm, size between the trays 56 cm, total load capacity 80 kg, 4 wheels with 2 brakes, unassembled, simple assembly

con 2 bandejas de acero inoxidable mate, 83 x 51 cm, la medida entre bandejas 56 cm, capacidad total 80 kg, 4 ruedas, con 2 frenos, construcción robusta, montaje fácil

2 niveaux, 83 x 51 cm chacun, distance entre niveaux 56 cm, capacité maxi 80 kg au total, 4 roues dont 2 avec frein, construction robuste, montage facile

	cm	↑ cm	€
11977	91 x 59	93	146,00

**GN 1/1 Regalwagen**

GN 1/1 trolley
GN 1/1 carro
GN 1/1 chariot



mit 15 DoppelaufLAGESCHIENEN, zum Transport von bis zu 30 GN-Tablets GN 1/2 oder 15 GN-Behältern bis GN 1/1 (Längseinschub), bei einem Stapelabstand von 75 mm, mit 4 Lenkrollen, 2 mit Feststellern, Tragfähigkeit 100 kg

15 double bars, for transporting up to 30 trays GN 1/2 or 15 GN containers up to GN 1/1 (lengthwise insertion), size between the trays 75 mm, with 4 swivel wheels, 2 with brakes, max. load 100 kg

15 raíles de soporte dobles, para transportar hasta 30 bandejas GN 1/2 o 15 cubetas GN hasta GN 1/1 (inserción longitudinal), distancia entre las bandejas de 75 mm, con 4 ruedas giratorias, 2 con freno, carga máxima de 100 kg

15 doubles rails de support, pour transporter jusqu'à 30 plateaux GN 1/2 ou 15 bacs GN jusqu'à GN 1/1 (insertion longitudinale), distance entre les plateaux 75 mm, avec 4 roues pivotantes, 2 avec frein, capacité de charge 100 kg

	cm	↑ cm	€
71441	55 x 38,5	173,5	268,00



mit beidseitiger Kipp- und Durchschubsicherung
with tilt and push-through protection on both sides

CUTLERY BOXES



Deckel für Besteckbehälter
 lid for cutlery container
 tapa para recipiente de cubiertos
 couvercle pour bac à couverts



passend für Besteckbehälter
 suitable for cutlery containers
 para recipiente de cubiertos
 pour bacs à couverts

	cm	↑ cm	fits to	€
11964	53 x 32,5	4	11954, 11955, 11960	6,30

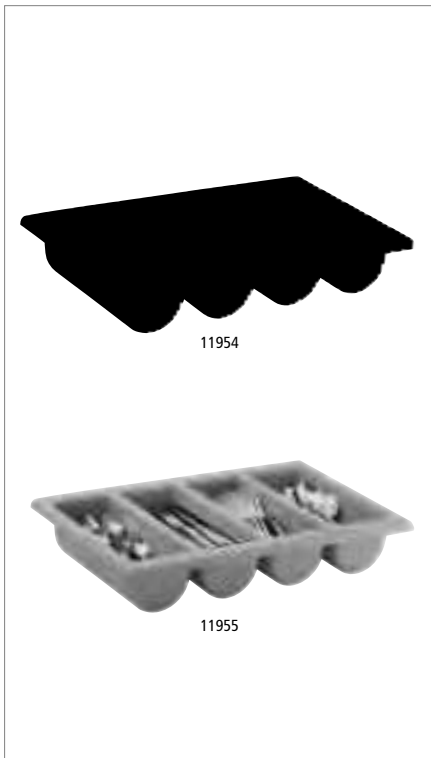
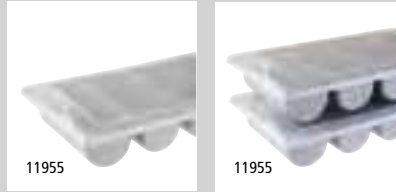

GN 1/1 Besteckbehälter

GN 1/1 cutlery bin
 GN 1/1 recipiente para cubiertos
 GN 1/1 récipients pour couverts



4 Mulden
 4 troughs
 4 compartimentos
 4 compartiments

	cm	↑ cm	Farbe / Colour	GN	€
11954	53 x 32,5	10		1/1	7,50
11955	53 x 32,5	10		1/1	7,50



GN 1/1 Besteckbehälter

GN 1/1 cutlery bin
 GN 1/1 recipiente para cubiertos
 GN 1/1 récipients pour couverts



3 Mulden, 3 Köcher
 3 troughs, 3 cutlery baskets
 3 compartimentos, 3 cestas para cubiertos
 3 compartiments, 3 corbeilles à couverts

	cm	↑ cm	Farbe / Colour	GN	€
11960	53 x 32,5	10		1/1	7,50



Besteckbehälter mit Deckel

cutlery box with cover
caja de cubiertos con tapa
range-couverts avec couvercle



Akazienholz, 4 Fächer (26 x 11,5 cm), mit Deckel

acacia wood, 4 compartments (26 x 11,5 cm), with cover
madera de acacia, 4 compartimentos (26 x 11,5 cm), con tapa
bois d'acacia, 4 compartiments (26 x 11,5 cm), avec couvercle

	cm	↑ cm	Farbe / Colour	€
11949	51 x 28	14,5	nature	78,00
11948	51 x 28	14,5	vintage white	78,00



Besteckbehälter

cutlery box
recipiente para cubiertos
récipient pour couverts



Akazienholz, 4 Fächer (26 x 11,5 cm)

acacia wood, 4 compartments (26 x 11,5 cm)
madera de acacia, 4 compartimentos (26 x 11,5 cm)
bois d'acacia, 4 compartiments (26 x 11,5 cm)

	cm	↑ cm	Farbe / Colour	€
11952	51 x 28	13	nature	53,00
11951	51 x 28	13	vintage white	53,00



GN 1/1 Besteckbehälter

GN 1/1 dispenser GN
GN 1/1 dispensador de cubiertos
GN 1/1 bac à couverts



in Handarbeit geflochten, 4 Mulden, Kunststoff-Geflecht, Drahtgestell, braun-schwarz

hand-woven, 4 troughs, plastic wickerwork, wire frame, brown-black
cesta trensada a mano, 4 compartimentos, mimbre de plástico, marco de alambre, marrón-negro
corbeille tressée à main, 4 compartiments, plastique tressé, armature en fil métallique, brun-noir

	cm	↑ cm	Farbe / Colour	GN	€
11966	53 x 32,5	9		1/1	43,00



GN 1/1 Besteckbehälter

GN 1/1 cutlery dispenser
GN 1/1 dispensador de cubiertos
GN 1/1 bac à couverts



4 Mulden, Kunststoff-Geflecht, Drahtgestell, beige

4 troughs, plastic wickerwork, wire frame, beige
4 compartimentos, mimbre de plástico, marco de alambre, beige
4 compartiments, plastique tressé, structure métallique, beige

	cm	↑ cm	Farbe / Colour	GN	€
11965	53 x 32,5	10		1/1	30,00

CUTLERY BOXES



Besteckbehälter

cutlery basket
recipiente para cubiertos
récipients pour couverts

4 Löcher inklusive 4 Edelstahl Köcher

4 holes including 4 stainless baskets

4 agujeros con 4 cestas de acero inoxidable

4 trous avec 4 corbeilles en acier inox



	cm	↑ cm	€
93321	27 x 27	15	84,00



11999

Besteckköcher

cutlery basket
cesta para cubiertos
corbeille à couverts

Edelstahl matt poliert / stainless steel matt polished / acero inoxidable pulido mate / acier inox poli mat



	Ø cm	↑ cm	€
11999	9,5	13,5	8,00



11998

Besteckköcher

cutlery basket
cesta para cubiertos
corbeille à couverts

Polyethylen weiß / polyethylene white plastic / polietileno blanco / polyéthylène blanc



	Ø cm	↑ cm	€
11998	9,5	13,5	2,90



Besteckkasten „INDUSTRIAL“

cutlery box
caja para cubiertos
boîte pour couverts

Metall, schwarz

metal, black

metal, negro

métal, noir



	cm	↑ cm	litr.	€
40676	23,0 x 15,5	13	2,4	15,20

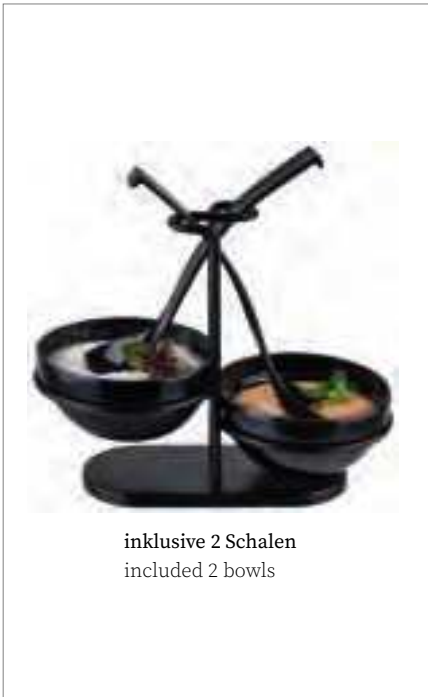

inklusive 2 Schalen
included 2 bowls

Löffelablage mit 2 Schalen
spoon rest with 2 bowls
reposa cucharas con 2 cuencos
repose-cuillère avec 2 bols

inklusive 2 Schalen, Ø 12 cm, H: 5,5 cm, 250 ml, ohne Löffel
with 2 bowls Ø 12 cm, h: 5,5 cm, 250 ml, without a spoon
con 2 cuencos Ø 12 cm, h: 5,5 cm, 250 ml, sin cuchara
avec 2 bols Ø 12 cm, h: 5,5 cm, 250 ml, sans cuillère



	cm	↑ cm	€
00651	23,5 x 12,5	19	19,00



Besteckablage
cutlery rest
reposa cuchara
pose-cuillère



	cm	↑ cm	€
00650	27 x 11	3,5	9,40



Besteckablage „SMALL WAVE“
cutlery rest
reposa cuchara
pose-cuillère



	cm	↑ cm	€
83897	26 x 13	4,5	10,90



Besteckablage „BOWL“
cutlery rest
reposa cuchara
pose-cuillère



	cm	↑ cm	ltr.	€
83803	22,5 x 11	6	0,5	7,80



Besteckablage „SPOON“
cutlery rest
reposa cuchara
pose-cuillère



	cm	↑ cm	€
83801	26 x 10,5	5	7,40



Teig- und Pizzaballenbehälter
 dough and pizza ball container
 recipiente para masa y bolas de pizza
 récipient à pâte et boules à pizza



Innenmaß 56,5 x 36,5 cm, H: 8,5 cm
 inner dimension 56,5 x 36,5 cm, H: 8,5 cm
 medida interior 56,5 x 36,5 cm, H: 8,5 cm
 dimension intérieure 56,5 x 36,5 cm, H: 8,5 cm

	cm	↑ cm	ltr.	€
82442 <small>NEW</small>	60 x 40	9	17	14,00
82440	60 x 40	7	13	12,00

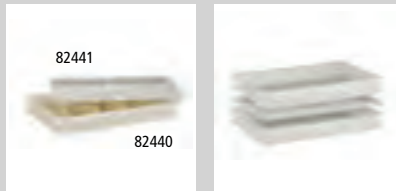

stapelbar
stackable

passender Deckel
fitting lid
tapa adecuada
couverture approprié



	cm	↑ cm		€
82441	60 x 40	1		10,00



Eier-Box
 eggs box
 caja para huevos
 boîte à oeufs



mit luftdichtem Deckel, für 4 Lagen à 30 Eier, Lieferung inkl. 4 Lagen, Größe Lage: 28 x 28 cm
 with airtight cover, capacity: 4 trays of 30 eggs, delivery with 4 trays, size of tray: 28 x 28 cm
 capacidad para 4 bandejas de 30 huevos, tapa hermética, se entrega con 4 bandejas, formato bandejas 28 x 28 cm, apto para lavavajillas
 pour 4 plateaux de 30 oeufs chacun, apte pour 4 plateaux plats, couvercle hermétique, livré avec 4 plateaux, dimension plateau 28x28 cm, lavable en lave-vaisselle

	cm	↑ cm	GN	€
82419	35,4 x 32,5	20	2/3	39,90

4 Lagen / 4 trays / 4 bandejas / 4 plateaux

	€
82420	12,50



Wanne
container
cubeta
bac



	cm	↑ cm	ltr.	€
11940	61 x 44	15	25	25,40



Wanne
container
cubeta
bac



	cm	↑ cm	ltr.	€
11950	55 x 42	14	20	12,40



Brotdose „LUNCHBUDDY“
lunchbox
fiambrella
boîte à lunch



Edelstahlbox mit Silikondichtung inklusive Trennsteg, auslaufsicher
stainless steel box with silicone seal incl. divider, leak-proof
caja de acero inoxidable con junta de silicona y divisor extraíble, transporte sin salpicaduras
boîte en acier inox avec joint en silicone et diviseur amovible, transport sans éclaboussures

	cm	↑ cm	ltr.	€
66900	18,5 x 13,5	6,5	0,8	14,50
66901	20,5 x 14,5	6,5	1,1	17,00
66902	22,5 x 16,5	6,5	1,4	19,50



Bar, Café & Drinkware

ASHTRAYS	544
BAR SPOONS	500
BAR STRAINERS	499
BOTTLE COOLERS	470
CHAMPAGNE BOWLS	476
CONFERENCE BOTTLE COOLERS	484
CRYSTAL	516
CORKSKREWS & BARBLADES	485
DRIP MATS	503
ICE BUCKETS	488
JIGGERS	496
JULEP MUGS	510
LIME AND LEMON SQUEEZERS	495
LINEA	514
MILK JUGS	528
MOSCOW MULE	506
MUDDLERS	498
PERFECTION	518
PITCHERS	486
SHAKERS	492
SNUG	522
STRAWS	505
TEAPOTS	524
TO GO	520
TRAYS	536
TONGS	491

BOTTLE COOLERS



Wein- / Sektkühler

wine / champagne bowl
cubitera para vino y cava
seau à vin ou champagne

mit 2 Griffen, extra stabiler eingerollter Rand

with 2 handles, rolled edge
con 2 asas, borde redondeado
avec 2 poignées, bord arrondi



	Ø cm	↑ cm	ltr.	Farbe / Colour	€
36115	21,5 / 15,0	22	5	black matt	48,00
36117 <small>new</small>	27,0 / 20,0	24	8	black matt	64,00

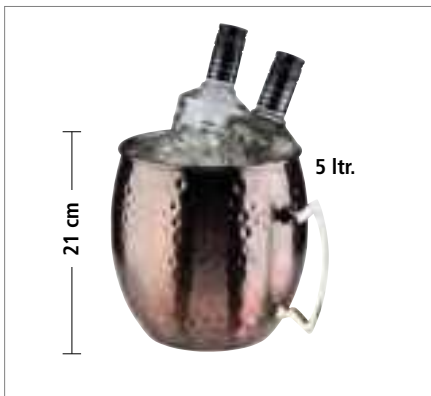

Flaschenkühler „MOSCOW MULE“

bottle cooler
enfriador de botellas
rafraîchisseur de bouteilles

Edelstahl-Flaschenkühler, gehämmert, Antik-Kupfer-Look

stainless steel cooler, hammered, copper antique look
enfriador de acero inoxidable, martillada, cobre estilo antiguo
rafraîchisseur en acier inox, martelée, cuivre style antique



	Ø cm	↑ cm	ltr.		€
93330	20	21	5	copper-antique-hammered	54,00



Wein- / Sektkühler

wine / champagne bowl
cubitera para vino y cava
seau à vin ou champagne

innen matt poliert, außen hochglanzpoliert, mit massiven Knopf-Griffen, extra stabiler eingerollter Rand, schwere Ausführung

outside mirror polished, inside matt polished, with solid knob handles, rolled edge, heavy quality
exterior pulido brillante, interior pulido mate, asas de botón robustas, borde redondeado, alta calidad
extérieur poli brillant, intérieur poli mat, 2 poignées robuste en forme de bouton, bord arrondi, haute qualité



	Ø cm	↑ cm	ltr.	€
36028	21,5 / 16	22	4	34,00



Wein- / Sektkühler „HAMMERSCHLAG“

wine / champagne bowl
cubitera para vino y cava
seau à vin ou champagne

hochglanzpoliert, gehämmert, mit massiven Ring-Griffen, eingerollter Rand

mirror polished, hammered, with solid ring handles, rolled edge, hammered
pulido brillante, martillada, con 2 anillos macizos, borde redondeado, repujado
brillant, martelée, 2 anneaux massifs, bord arrondi, surface martelée



	Ø cm	↑ cm	ltr.	€
36026	21 / 17	21,5	4	19,00



Wein- / Sektkühler

wine / champagne bowl
cubitera para vino y cava
seau à vin ou champagne



innen matt poliert, außen hochglanzpoliert, mit massiven Griffen, Rand eingerollt
outside mirror polished, inside matt polished, with massive handles, rolled edge
exterior pulido brillante, interior pulido mate, 2 asas macizas, borde redondeado
extérieur poli brillant, intérieur poli mat, 2 anses massives, bord rond

	Ø cm	↑ cm	ltr.	€
36025	21 / 15	21	3,5	18,00



Wein- / Sektkühler

wine / champagne bowl
cubitera para vino y cava
seau à vin ou champagne



matt poliert, Hohlgriffe / matt polished, hollow handles / pulido mate, con asas huecas / poli mat, 2 boutons creux

	Ø cm	↑ cm	ltr.	€
36021	20 / 15	20,5	4	16,00



Wein- / Sektkühler

wine / champagne bowl
cubitera para vino y cava
seau à vin ou champagne



aussen hochglanzpoliert, innen matt poliert, mit Ring-Griffen
outside mirror polished, inside matt polished, with ring handles
exterior pulido brillante, interior pulido mate, con 2 asas anillos
extérieur poli brillant, intérieur poli mat, avec 2 anneaux

	Ø cm	↑ cm	ltr.	€
36020	20 / 15	19	3	14,80



Wein- / Sektkühler

wine / champagne bowl
cubitera para vino y cava
seau à vin ou champagne



glasklar, mit Tragegriff
transparent, handle on the side
transparente, con un asa en el lateral
transparent, avec poignée

	cm	↑ cm	ltr.	€
36055	23 x 22	27,5	3	23,00



Wein- / Sektkühler

wine / champagne bowl
cubitera para vino y cava
seau à vin ou champagne



glasklarer Rand, transparent gefrostet
edge transparent, body transparent frosted
borde transparente, cuerpo transparente efecto glaseado
bord transparent, corps poli mat

	Ø cm	↑ cm	ltr.	€
36066	22 / 14	23	4	9,80

STANDS & TABLE HOLDERS



Wein- / Sektkühler

wine / champagne bowl
cubitera para vino y cava
seau à vin ou champagne

mit 2 Griffen, extra stabiler eingerollter Rand
with 2 handles, rolled edge
con 2 asas, borde redondeado
avec 2 poignées, bord arrondi



	Ø cm	↑ cm	ltr.	Farbe / Colour	€
36117	27 / 20	24	8	black matt	64,00

Ständer für Wein- / Sektkühler

stand for wine / champagne bowl
pie porta champañera / vino
pied pour seau à champagne / vin
schwerer standsicherer Fuß

heavy stable foot
pie pesado y estable
pied lourd et stable



	Ø cm	↑ cm	Farbe / Colour	€
36118	24,5 / 26,5	73	black matt	110,00



Wein- / Sektkühler

wine / champagne bowl
cubitera para vino y cava
seau à vin ou champagne

mit 2 Griffen, extra stabiler eingerollter Rand
with 2 handles, rolled edge
con 2 asas, borde redondeado
avec 2 poignées, bord arrondi



	Ø cm	↑ cm	ltr.	Farbe / Colour	€
36115	21,5 / 15	22	5	black matt	48,00



Ständer für Wein- / Sektkühler

stand for wine / champagne bowl
pie porta champañera / vino
pied pour seau à champagne / vin
schwerer standsicherer Fuß

heavy stable foot
pie pesado y estable
pied lourd et stable



	Ø cm	↑ cm	Farbe / Colour	€
36116	19,5 / 26,5	71,5	black matt	100,00



Ständer für Wein- / Sektkühler

stand for wine / champagne bowl
pie porta champañera / vino
pied pour seau à champagne / vin

hochglanzpoliert, schwerer standsicherer Fuß, Innendurchmesser der Schale Ø 17,5 cm
mirror polished, heavy foot, inner bowl Ø 17,5 cm
acabado pulido efecto brillante, bol interior de Ø 17,5 cm
brillant, intérieur support Ø 17,5 cm



	Ø cm	↑ cm	€
36069	17,5 / 26,5	73	118,00



Wein- / Sektkühler no. 36028
wine / champagne bowl no. 36028
cubitera para vino y cava no. 36028
seau à vin ou champagne no. 36028

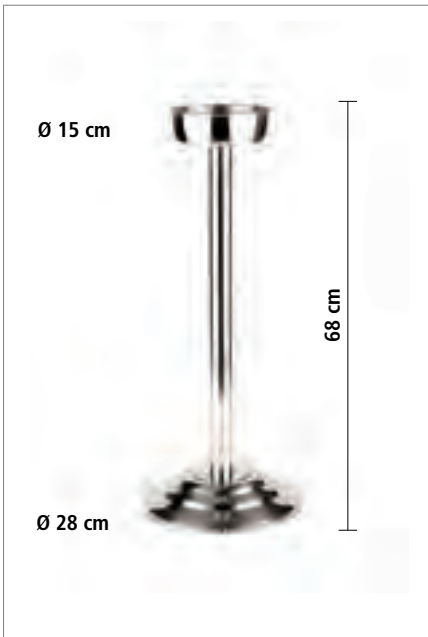

Ständer für Wein- / Sektkühler

stand for wine / champagne bowl
pie porta champañera / vino
pied pour seau à champagne / vin

hochglanzpoliert, schwerer standsicherer Fuß, Innendurchmesser der Schale Ø 15 cm
mirror polished, heavy foot, inner bowl Ø 15 cm
acabado pulido efecto brillante, bol interior de Ø 15 cm
brillant, intérieur support Ø 15 cm



	Ø cm	↑ cm	€
36068	15 / 28	68	90,00

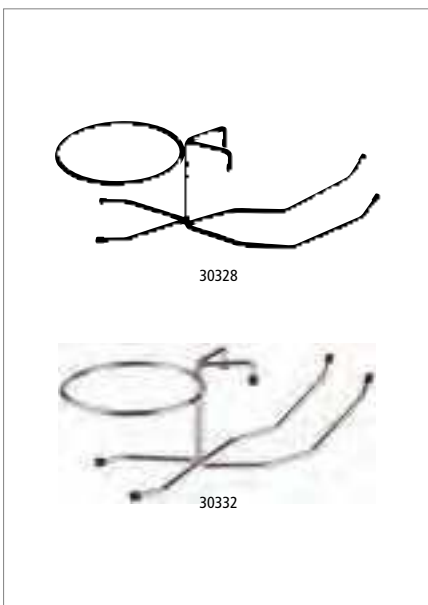

Tischhalterung für Sektkühler

champagne bucket table holder
soporte de mesa para champañera
porte-seau à champagne

aus 8 mm starkem Stahldraht, passend zu allen lieferbaren Sektkühlern, innen Ø-Ring: 18 cm
8 mm chrome plated wire, suitable for all available champagne buckets, inner ring Ø 18 cm
alambre cromado 8 mm, para todas las champañeras, anillo interior Ø 18 cm
fil chromé 8 mm, pour tous les seaux à champagne, anneau intérieur Ø 18 cm



	cm	↑ cm	Farbe / Colour	€
30328 NEW	49 x 20	17	black matt	18,00
30332	49 x 20	17	stainless steel	18,00

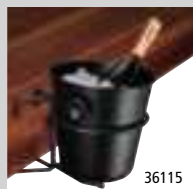

BOTTLE COOLERS



Flaschenkühler

bottle cooler
enfriador de botella
rafraîchisseur de bouteille

gehämmert, doppelwandig für beste Isolierung

hammered, double-walled for best insulation

martillada, doble pared para un mejor aislamiento

martelée, double paroi pour une meilleur isolation



	Ø cm	↑ cm	ltr.	Farbe / Colour	€
36120	33	20	8	stainless	68,00
36121	33	20	8	copper-look	68,00



Präsentationsmöglichkeit
presentation examples



Wein- / Sektkühler „XL“

wine / champagne bowl
cubitera para vino y cava
seau à vin ou champagne

gehämmert, mit 2 seitlichen Eingriffen

hammered, with 2 handles on the side

martillada, con 2 asas

martelée, avec 2 poignées



	cm	↑ cm	ltr.	Farbe / Colour	€
36111	30 x 23,5	23	7	copper-look	65,00
36112	30 x 23,5	23	7	gunmetal-look	65,00



Wein- / Sektkühler „LARGE“

wine / champagne bowl
cubitera para vino y cava
seau à vin ou champagne

gehämmert, mit 2 seitlichen Eingriffen, für 1-2 Flaschen

hammered, with 2 handles on the side, for 1-2 bottles

martillada, con 2 asas, para 1-2 botellas

martelée, avec 2 poignées, pour 1-2 bouteilles



	cm	↑ cm	ltr.	Farbe / Colour	€
36108	25,5 x 19	20	3,9	copper-look	35,00
36109	25,5 x 19	20	3,9	gunmetal-look	35,00



Wein- / Sektkühler „SMALL“

wine / champagne bowl
cubitera para vino y cava
seau à vin ou champagne

gehämmert, für 1 Flasche

hammered, for 1 bottle

martillada, para 1 botella

martelée, pour 1 bouteille



	cm	↑ cm	ltr.	Farbe / Colour	€
36106	20,5 x 14	17	2,1	copper-look	26,00
36107	20,5 x 14	17	2,1	gunmetal-look	26,00



Flaschenkühler „BIG BOWL“

bottle cooler
enfriador de botella
rafraîchisseur de bouteille



gehämmert, innen matt poliert, herausnehmbarer Tropfeinsatz
hammered, inside matt polished, removable drip tray
martillada, interior pulido mate, bandeja de goteo extraíble
martelée, intérieur poli mat, bac d'égouttage amovible

	Ø cm	↑ cm	ltr.	€
36130	37	23	8	240,00

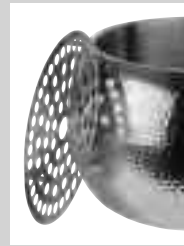

herausnehmbarer
Tropfeinsatz
removable drip tray



36100 11 ltr.

36101 11 ltr.

36096 18 ltr.

Getränkewanne „TIN“

beverage tub
barreño botellines
bassine à glace



Metall verzinkt, mit Kunststoffeinsatz
galvanised metal, with plastic insert
metal galvanizado, con inserto de plástico
métal galvanisé, avec insert en plastique

	cm	↑ cm	ltr.	Farbe / Colour	€
36100	40 x 28	22	11	copper-look	36,00
36101	40 x 28	22	11	black-metal-look	31,00
36095	40 x 28	22	11	metal-look	30,00
36096	50 x 23	23	18	metal-look	36,00



mit Kunststoffeinsatz
with plastic insert
con inserto de plástico
avec insert en plastique



71490

Kreidestift zum Beschriften
chalk marker for writing
S. 348

WINE & CHAMPAGNE BOWLS



Champagnerkühler

champagne bowl
cubo champañera
seau à champagne

hochglanzpoliert, doppelwandig für beste Isolierung

mirror polished, double wall cooler keeps the temp. for a long time

pulido brillante con champañera inox de doble pared

poli brillante, double paroi, maintient le froid plus longtemps



	Ø cm	↑ cm	ltr.	€
36044	44 / 25	24	10,5	102,00



Champagnerkühler

champagne bowl
cubo champañera
seau à champagne

hochglanzpoliert

mirror polished

pulido brillante

poli brillante



	Ø cm	↑ cm	ltr.	€
36045	40,5 / 27,5	22,5	13,5	60,00



Champagnerkühler

champagne bowl
cubo champañera
seau à champagne

hochglanzpoliert, Rand matt poliert

mirror polished, edge matt polished

pulido brillante, borde pulido mate

poli brillante, bord poli mat



	Ø cm	↑ cm	ltr.	€
36046	45 / 21	23	12	52,00



Wein- / Sektkühler

wine / champagne bowl
cubitera para vino y cava
seau à vin ou champagne

glasklar, für bis zu 6 Flaschen geeignet
transparent, suitable for up to 6 bottles
transparente, para máximo 6 botellas
transparent, maxi 6 bouteilles



	cm	↑ cm	ltr.	€
36057	47 x 28	23	10	41,00



Wein- / Sektkühler

wine / champagne bowl
cubitera para vino y cava
seau à vin ou champagne

mit seitlichen Griffen, transparent
with lateral handles, transparent
con asas laterales
avec poignées latérales



	cm	↑ cm	ltr.	€
36087	32 x 21,5	24,5	7	31,00



36048

Wein- / Sektkühler

wine / champagne bowl
cubitera para vino y cava
seau à vin ou champagne

mit 2 seitlichen Eingriffen
with 2 handles on the side
con 2 asas
avec 2 poignées



	cm	↑ cm	ltr.	€
36048	35 x 27	25,5	6	31,00
36052	27 x 20	21	3	17,20



36054

Wein- / Sektkühler

wine / champagne bowl
cubitera para vino y cava
seau à vin ou champagne

mit 2 seitlichen Eingriffen
with 2 handles on the side
con 2 asas
avec 2 poignées



	cm	↑ cm	ltr.	€
36054	35 x 27	25,5	6	37,00
36053	27 x 20	21,0	3	22,00

BOTTLE COOLERS



Flaschenkühler „TERRAZZO“

bottle cooler
enfriador de botella
rafraîchisseur de bouteille

Terrazzooptik, möbelschonende Unterseite
terrazzo look, furniture-friendly underside
aspecto terrazo, con base anti rayaduras
optique terrazzo, avec revêtement antirayures



	Ø cm	↑ cm	Farbe / Colour	€
36150	12,5 / 10	19	 terrazzo	20,00



Flaschenkühler „ELEMENT“

bottle cooler
enfriador de botella
rafraîchisseur de bouteille

möbelschonende Unterseite
furniture-friendly underside
con base anti rayaduras
avec revêtement antirayures



	Ø cm	↑ cm	Farbe / Colour	€
36131	12 / 10	19	 concrete	20,00



Flaschenkühler „ELEMENT“

bottle cooler
enfriador de botella
rafraîchisseur de bouteille
möbelschonende Unterseite
non-scratching undersurface
base anti rayaduras
base revêtement antirayures



	Ø cm	↑ cm	Farbe / Colour	€
36104	12 / 10	19	 rose	20,00



Flaschenkühler „ELEMENT“

bottle cooler
enfriador de botella
rafraîchisseur de bouteille
möbelschonende Unterseite
non-scratching undersurface
base anti rayaduras
base revêtement antirayures



	Ø cm	↑ cm	Farbe / Colour	€
36105	12 / 10	19	 green	20,00



Flaschenkühler „ELEMENT“

bottle cooler
enfriador de botella
rafraîchisseur de bouteille
möbelschonende Unterseite
non-scratching undersurface
base anti rayaduras
base revêtement antirayures



	Ø cm	↑ cm	Farbe / Colour	€
36090	12 / 10	19	 concrete	20,00



Flaschenkühler „ELEMENT“

bottle cooler
enfriador de botella
rafraîchisseur de bouteille
möbelschonende Unterseite
non-scratching undersurface
base anti rayaduras
base revêtement antirayures



	Ø cm	↑ cm	Farbe / Colour	€
36099	12 / 10	19	 black	20,00

BOTTLE COOLERS



Flaschenkühler „WAIST“

bottle cooler
enfriador de botella
rafraîchisseur de bouteille

hochglanzpoliert, doppelwandig für beste Isolierung

mirror polished, double-walled for best insulation
poli brillante, doble pared para un mejor aislamiento
pulido brillante, double paroi pour une isolation optimale



	∅ cm	↑ cm	€
36129	13 / 10	19	19,00



Flaschenkühler

bottle cooler
enfriador de botella
rafraîchisseur de bouteille

matt poliert, doppelwandig für beste Isolierung

matt polished, double wall cooler keeps the temperature for a long time
pulido mate con doble pared para mantener el frio largo tiempo
poli mat, double paroi pour une meilleure conservation de la température



	∅ cm	↑ cm	€
36038	12,5 / 10	19	23,00



Flaschenkühler

bottle cooler
enfriador de botella
rafraîchisseur de bouteille

matt poliert, doppelwandig für beste Isolierung

matt polished, double wall cooler keeps the temperature for a long time
pulido mate con doble pared para mantener el frio largo tiempo
poli mat, double paroi pour une meilleure conservation de la température



	∅ cm	↑ cm	€
36030	12 / 10	20	18,00



Flaschenkühler „GOLD“

bottle cooler
enfriador de botella
rafraîchisseur de bouteille



gehämmert, doppelwandig für beste Isolierung

hammered, double-walled for best insulation
martillada, doble pared para un mejor aislamiento
martelée, double paroi pour une isolation optimale

	Ø cm	↑ cm	Farbe / Colour	€
36128	12 / 10	20		26,00



Flaschenkühler „COPPER“

bottle cooler
enfriador de botella
rafraîchisseur de bouteille



gehämmert, doppelwandig für beste Isolierung

hammered, double-walled for best insulation
martillada, doble pared para un mejor aislamiento
martelée, double paroi pour une isolation optimale

	Ø cm	↑ cm	Farbe / Colour	€
36074	12 / 10	20		26,00



Flaschenkühler „FROSTFIRE“

bottle cooler
enfriador de botella
rafraîchisseur de bouteille



Antihafbeschichtung / non stick coating / antiadherente / revêtement anti-adhésif

	Ø cm	↑ cm	Farbe / Colour	€
36140	11,5 / 11	15	black / silver	17,60

BOTTLE COOLERS



Flaschenkühler „LEVANTE“

bottle cooler
enfriador de botella
rafraîchisseur de bouteille

doppelwandig für beste Isolierung

double wall cooler keeps the temperature for a long time
con doble pared para mantener el frio largo tiempo
double paroi pour une meilleure conservation de la température



	Ø cm	↑ cm	Farbe / Colour	€
36125	12 / 10	20	 copper red	24,00



Flaschenkühler „LEVANTE“

bottle cooler
enfriador de botella
rafraîchisseur de bouteille

doppelwandig für beste Isolierung

double wall cooler keeps the temperature for a long time
con doble pared para mantener el frio largo tiempo
double paroi pour une meilleure conservation de la température



	Ø cm	↑ cm	Farbe / Colour	€
36126	12 / 10	20	 blue	24,00



Flaschenkühler „LEVANTE“

bottle cooler
enfriador de botella
rafraîchisseur de bouteille

doppelwandig für beste Isolierung

double wall cooler keeps the temperature for a long time
con doble pared para mantener el frio largo tiempo
double paroi pour une meilleure conservation de la température



	Ø cm	↑ cm	Farbe / Colour	€
36127	12 / 10	20	 black	24,00



Flaschenkühler

bottle cooler
enfriador de botella
rafraîchisseur de bouteille

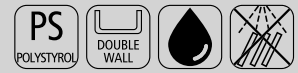

transparent, doppelwandig für beste Isolierung, mit Chromrand

transparent, double wall cooler keeps the temperature for a long time, with chrome edg
transpar., doble pared mantiene la temperatura por largo tiempo, borde superior cromado
transparent, bord chromé brillant, double paroi pour maintien en température

	Ø cm	↑ cm	Farbe / Colour	€
36032	12 / 10	23		10,00
36034	12 / 10	23		10,00



Flaschenkühler „PURE“

bottle cooler
enfriador de botella
rafraîchisseur de bouteille



doppelwandig für beste Isolierung, glasklar

double wall cooler keeps the temperature for a long time, clear
doble pared mantiene la temperatura por largo tiempo, transparente
double paroi pour maintien en température, transparent

	Ø cm	↑ cm	€
36063	13,5 / 10,5	23	9,00
36062	13,5 / 10,5	23	9,00



Wein- / Sektkühler

wine / champagne bowl
cubitera para vino y cava
seau à vin ou champagne



glasklar, für zwei Flaschen

clear, for two bottles
transparente, para 2 botellas
transparent, pour 2 bouteilles

	cm	↑ cm	litr.	€
36056	30,5 x 21,5	26	4	22,00

CONFERENCE BOTTLE COOLERS



Flaschenkühler „CONFERENCE“

conference bottle cooler
enfriador múltiple
rafraîchisseur



inkl. Kühllakku, Flaschenöffner, Kronkorkenschale,
mit 6 Öffnungen Ø 6,7 cm für 0,25 - 0,5 Liter-Flaschen

incl. bottle cooler, bottle opener, small cap bowl,
with 6 holes Ø 6,7 cm for 0,25 to 0,5 liter bottle
con acumulador de frío, abridor, recuperador de chapas,
6 plazas Ø 6,7 cm, para botellas de 25 a 50 cl
avec accumulateur de froid, décapsuleur, bol récupérateur
de capsules, 6 places Ø 6,7 cm, pour bouteilles de 25 à 50 cl

	Ø cm	↑ cm	Farbe / Colour	€
00620	23	15	White	54,00
00621	23	15	Black	54,00

Kühllakku / cooler / acumulador de frío / accumulateur de froid

	Ø cm	↑ cm	Farbe / Colour	€
00615	7,5	11,5	Black	10,50

Kronkorkenschale / cap bowl / cuenco para chapas / bol récupérateur de capsules

	Ø cm	↑ cm	Farbe / Colour	€
00618	6,5	3	White	2,50
00619	6,5	3	Black	2,50

Flaschenöffner / bottle opener / abridor / décapsuleur

	Ø cm	→ cm	€
00617	1	13,5	6,30

Einrollautomatik
automatic retraction



Schnur 65 cm lang
65 cm long cord

Schlüsselschnur, 2er Set

key cord, 2 pcs.
llavero enrollable
porte-clés avec câble à enroulement



Befestigung mit Klammer am Gürtel, starke Rückzugfeder
to fix at waistbelt, strong pull-back spring
se fija en el cinturón, cable retrocede automáticamente
à fixer à la ceinture, enroulage automatique

	Ø cm	↑ cm	€
93170	4	2	7,60



Kellnermesser „BOTTLEMASTER“

waiter's corkscrew
sacacorchos de camarero
tire-bouchons



leichtgängige Teflon-Spirale, mehrstufige Klapphebelfunktion, am Fuß angebrachtes Messer
easy moving teflon coil, 2-stage opening system, knife at the bottom end
mecha de teflón, sistema de apertura en 2 golpes, con cuchillo en la parte superior
mèche téflon, ouverture en 2 étapes, couteau dans la partie supérieure

	→ cm	€
93302	11,5	10,80



Kellnermesser

waiter's corkscrew
sacacorchos de camarero
tire-bouchons



leichtgängige Teflon-Spirale, mehrstufige Klapphebelfunktion, am Kopf angebrachtes Messer
easy moving teflon coil, 2-stage opening system, knife at the top end
mecha de teflón, sistema de apertura en 2 golpes, con cuchilla en la parte superior
mèche téflon, ouverture en 2 étapes, couteau dans la partie supérieure

	→ cm	€
93301	12	5,20



Kellner-Flaschenöffner

waiter's barblade
abridor camarero
décapsuleur



magnetisch, schwarz / magnetic, black / magnético, negro / magnétique, noir

	→ cm	€
93377	18	4,20



Kellner-Flaschenöffner

waiter's barblade
abridor camarero
décapsuleur



magnetisch, matt poliert / magnetic, matt polished / magnético, pulido mate / magnétique, poli mat

	→ cm	€
93122	18	3,70

matt poliert / matt polished / pulido mate / poli mat

	→ cm	€
00617	13,5	6,30



mit Gummierung
with rubber coating

Kellner-Flaschenöffner

waiter's barblade
abridor camarero
décapsuleur



magnetisch, mit Gummierung

magnetic, with rubber coating

magnético, con revestimiento de goma

magnétique, avec revêtement en caoutchouc

	→ cm	€
93125	11	4,30

PITCHERS



NEW

Wasserkanne

water pitcher
jarra de agua
pichet à eau



hochglanzpoliert, mit Ausgieß-Stopper für Eiswürfel oder Früchte
mirror-polished, with pouring stopper for ice cubes or fruit
pulido brillante, con tope vertedor para cubios de hielo o fruta
poli brillant, avec arrêt de versement pour les glaçons ou les fruits

	Ø cm	↑ cm	ltr.	€
10695	9	27,5	1,2	21,00



Pitcher

pitcher
jarra
pichet



	Ø cm	↑ cm	ltr.	€
93105	13	21	1,5	10,40



einfaches Eingießen
easy pouring



Pitcher

pitcher
jarra
pichet



	Ø cm	↑ cm	ltr.	€
93091	13,5	20	1,5	10,00



einfaches Eingießen
easy pouring



stapelbar
stackable



Weinflaschenhalter

winebottle-stand
soporte para botella de vino
porte-bouteille



	cm	↑ cm	€
30333	22 x 6	20,5	9,40



Kühlmanschette „CHAMPAGNE“

cool collar
funda de frío
housse isotherme



für Sekt- / Champagnerflaschen, einfach im Gefrierfach einfrieren, komplette Flasche wird in 5 Min. auf angenehme Trinktemperatur gekühlt, außen reißfestes Stoffgewebe, innen Kunststoff mit Kühlgel gefüllt, unbegrenzt wiederverwendbar

for bottles of champagne, simply to freeze in the freezer, complete bottles will be cooled down in only 5 minutes, tearproof cloth outside, plastic filled with gel inside, unlimited reusable
para botellas de cava o champán simplemente congelándola en el congelador, la botella entera se enfriará en 5 minutos, funda de plástico muy robusta, rellena con un gel congelante reutilizable ilimitadamente

pour bouteilles de vin ou champagne, la housse est préalablement stockée au congélateur, où elle accumule le froid, ensuite elle refroidit une bouteille en quelques minutes, plastique résistant, contient un liquide congelant, à réutiliser de façon illimitée

	Ø cm	↑ cm	€
36075	11	18	7,00

ICE CUBE MAKERS



Eiswürfelform mit Deckel, 2er Set

ice cube maker with lid, 2 pcs.
molde para cubitos de hielo con tapa, set de 2
moule à glaçons avec couvercle, set de 2

2 Eiswürfelformen für je 9 Eiswürfel

2 ice cube moulds for 9 ice cubes each
2 moldes de cubitos de hielo para 9 cubitos cada uno
2 moules à glaçons pour 9 glaçons chacun



	cm	↑ cm	ice cubes	pcs.	€/ set
36102	15,5 x 15,5	5,5	4 x 4 x 4	2	17,00



Die Eiswürfel lassen sich leicht auslösen
the ice cubes are easy to release



Eiswürfelform mit Deckel, 2er Set

ice cube maker with lid, 2 pcs.
molde para cubitos de hielo con tapa, set de 2
moule à glaçons avec couvercle, set de 2

2 Eiswürfelformen für je 21 Eiswürfel

2 ice cube moulds for 21 ice cubes each
2 moldes de cubitos de hielo para 21 cubitos cada uno
2 moules à glaçons pour 21 glaçons chacun



	cm	↑ cm	ice cubes	pcs.	€/ set
36103	25 x 15	4	4 x 2,5 x 3	2	12,00



Eiskugelformer

ice ball former
molde de cubitos de hielo esféricos
moule à glaçons en boules

2-teilig, 3 Kugeln à 100 ml, einfach mit Wasser füllen und gefrieren lassen

3 bowls à 100 ml, simply fill with water and allow to freeze
3 bolas de 100 ml, simplemente llenar con agua y dejar congelar
3 boules à 100 ml, simplement remplir avec de l'eau et mettre à congeler



	cm	↑ cm	ice balls	€
12990	23,5 x 8,5	6,5	Ø 6	11,00

ICE BUCKETS



Eisbox „ARCTIC“
icebox
cubitera
seau à glaçons



Innenbehälter dient als Tropfeinsatz, Eisbox ist mit bis zu 300 Eiswürfeln befüllbar
inner container serves as drainer, ice box can be filled with up to 300 ice cubes
contenedor interior sirve como inserto de goteo, puede contener hasta 300 cubitos de hielo
réceptier intérieur sert d'égouttoir, le bac à glaçons peut être rempli avec jusqu'à 300 glaçons

	Ø cm	↑ cm		Farbe / Colour	€
36006 <small>NEW</small>	27	20	6	black matt	59,00
36037	27	20	6	aluminium	57,00



Eisbox „ARCTIC“
icebox
cubitera
seau à glaçons



Innenbehälter dient als Tropfeinsatz, hält bis zu 5 Stunden die Eiswürfel in ihrer Form
inner container serves as drainer, keeps the ice cubes in shape for up to 5 hours
contenedor interior sirve como inserto de goteo, mantiene los cubitos de hielo en forma hasta 5 horas
réceptier intérieur sert d'égouttoir, maintient les glaçons dans leur forme jusqu'à 5 heures

	Ø cm	↑ cm	ltr.		€
36033	18,5	20	3	max. 150 ice cubes	43,80





Eiseimer-Set mit Eiszange „POLAR“

ice bucket set with tongs
cubitera clásica con pinza
seau à glaçons classique avec pince



mit Abtropfgitter, isolierter Kunststoffeinsatz, Zange lässt sich im Deckel verstauen, für max. 50 Eiswürfel, hält die Eiswürfel bis zu 5 Stunden in ihrer Form

with drainer, insulated plastic insert, tongs can be stored in the lid, for max. 50 ice cubes, keeps the ice cubes in shape for up to 5 hours

con escurridor, inserto de plástico aislado, la pinza se puede guardar en la tapa, para un máximo de 50 cubitos de hielo, mantiene los cubitos de hielo en forma hasta 5 horas

avec égouttoir, insert en plastique isolé, la pince peut être rangée dans le couvercle, pour max. 50 glaçons, maintient les glaçons dans leur forme jusqu'à 5 heures

	Ø cm	↑ cm	ltr.	Farbe / Colour	€
36016	14	22	1,3	■	30,00
36015	14	22	1,3	■	30,00



Eiseimer-Set mit Eiszange

ice bucket set with tongs
cubitera clásica con pinza
seau à glaçons classique avec pince

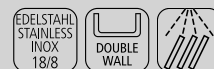

für max. 45 Eiswürfel, hält die Eiswürfel bis zu 5 Stunden in ihrer Form

max. 45 ice cubes, keeps the ice cubes in shape for up to 5 hours

para un máximo de 45 cubitos de hielo, mantiene los cubitos de hielo en forma hasta 5 horas

pour max. 45 glaçons, maintient les glaçons dans leur forme jusqu'à 5 heures

	Ø cm	↑ cm	ltr.	€
36013	12	14	1	32,00



3-teiliges Set
3 pcs.



Eisbox

icebox
cubitera
seau à glaçons



Innenbehälter dient als Tropfeinsatz, hält die Eiswürfel bis zu 5 Stunden in ihrer Form

inner container serves as drainer, ice bucket keeps the ice cubes in shape for up to 5 hours

contenedor interior sirve como inserto de goteo, mantiene los cubitos de hielo en forma hasta 5 horas

réceptier intérieur sert d'égouttoir, maintient les glaçons dans leur forme jusqu'à 5 heures

	cm	↑ cm	ltr.	€
93220	27 x 27	15	5	max. 300 ice cubes 49,00



Eisbox

icebox
cubitera
seau à glaçons



Innenbehälter dient als Tropfeinsatz, hält die Eiswürfel bis zu 5 Stunden in ihrer Form

inner container serves as drainer, ice bucket keeps the ice cubes in shape for up to 5 hours

contenedor interior sirve como inserto de goteo, mantiene los cubitos de hielo en forma hasta 5 horas

réceptier intérieur sert d'égouttoir, maintient les glaçons dans leur forme jusqu'à 5 heures

	cm	↑ cm	ltr.	€
93200	20 x 20	17	3,4	max. 150 ice cubes 33,00

ICE BUCKETS



36003

36004

Mini-Eiseimer / Mini-Sektkühler

ice bucket
cubitera clásica
seau à glaçons classique



	Ø cm	↑ cm	ltr.	€
36003	10,5	10	0,5	8,60
36004	13,0	13	1,0	11,00



Eiszerkleinerer

Ice crusher
picadora de hielo
broyeur à glaçons

glasklar, mit Edelstahl-Messer
clear, stainless steel cutters
cuchillas de acero inoxidable
couteaux inox



	cm	↑ cm	€
36017	12 x 12	24	18,10



Eisschaufel

ice scoop
pala de hielo
pelle à glaçons



	cm	→ cm	ltr.	€
93192	10 x 6	29	0,7	8,90



Eisschaufel

ice scoop
pala de hielo
pelle à glaçons

gelocht, ideal zum Befüllen von schlanken Gläsern
perforated, ideal to fill narrow glasses
perforada, ideal para llenar vasos estrechos
perforée, idéale pour verser les glaçons dans des verres étroits



	Ø cm	→ cm	€
93191	5	19,5	7,50



Eiszange

ice tongs
pinzas para hielo
pinçe de la glace

hochglanzpoliert, mit Befestigungsclip

mirror polished, with fastening clip
pulido brillante, con clip de fijación
poli brillant, avec clip de fixation



	→ cm	Farbe / Colour	€
75853	20	stainless steel-look	4,60
75854	20	copper-look	5,00
75855	20	gunmetal-look	5,00



Zange kann an einer Schale befestigt werden
tongs can be attached to a bowl

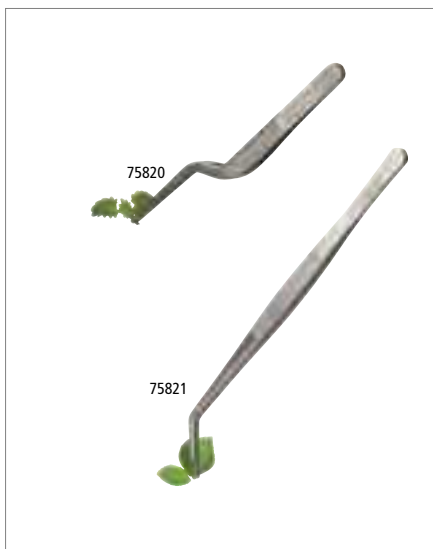

Pinzettenzange

fine tongs / tweezer
pinza de emplatar
pinçe à dresser

hochglanzpoliert, geriffelte Grifffläche, schwere Qualität

mirror polished, ribbed handle, heavy gauge
pulido brillante, mango cómodo ranurado, alta calidad
poli brillant, manche rainuré antiglisse, qualité extra



	→ cm	€
75820	16	6,60
75821	30	9,90



Eiszange

ice cube tongs
pinza para cubitos de hielo
pinçe à glaçons

hochglanzpoliert, fugenlos

mirror polished, seamless
pulido brillante, de una sola pieza
poli brillant, d'une seule pièce



	cm	→ cm	€
75805	5 x 2	17,5	2,40

SHAKERS



Parisian Shaker

shaker
coctelera
shaker



2-teiliges Set, Edelstahlbecher, mattiert

2 pieces, stainless steel cup, matt polished

set de 2, taza de acero, pulido mate

set de 2, gobelet en acier, poli mat

	Ø cm	↑ cm	ltr.	€
93179	9,5	24	0,7	17,90

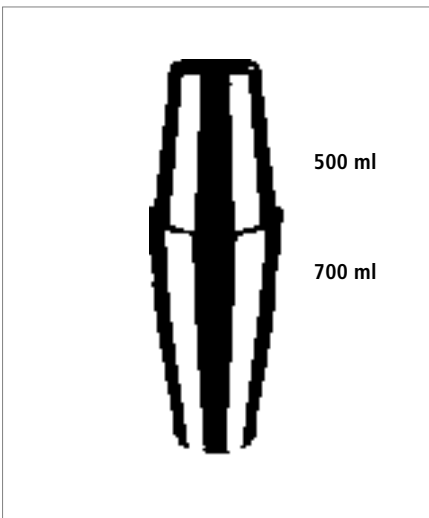

500 ml

700 ml

Tin in tin Shaker

tin in tin shaker
coctelera tin in tin
shaker tin in tin



2-teiliges Set, Edelstahlbecher, hochglanzpoliert

2 pieces, stainless steel cup, mirror polished

set de 2, taza de acero, pulido brillante

set de 2, gobelet en acier, poli brillant

	Ø cm	↑ cm	ltr.	€
93203	9	27	0,7 / 0,5	16,00

Ersatztrinkbecher / spare drinking cup / vaso de recambio / gobelet de rechange

	Ø cm	↑ cm	ltr.	€
93204	8,5	13	0,5	8,00



400 ml

700 ml

Boston Shaker

boston shaker
coctelera boston
shaker boston



2-teiliges Set: Becher, 700 ml, gummiert, rutschfest + Glas, 400 ml

2 pcs.: beaker, 700 ml, rubberized, anti-slip + glass, 400 ml

set de 2: vaso coctelero con goma exterior 700 ml + vaso de vidrio 400 ml

set de 2: bol mélangeur inox extérieur plastifié couleur 700 ml + bol en verre 400 ml

	Ø cm	↑ cm	ltr.	€
93139	9	30	0,7	15,20

Ersatzglas / spare glass / vaso de recambio / verre de rechange

	Ø cm	↑ cm	ltr.	€
93138	8,5	14,5	0,4	9,30



Boston Shaker
boston shaker
coctelera boston
shaker boston



2-teiliges Set: Becher, 700 ml + Glas, 400 ml

2 pcs.: beaker, 700 ml + glass, 400 ml

set de 2: vaso coctelero, 700 ml+ vaso vidrio 400 ml

set de 2: bol mélangeur, 700 ml + bol en verre 400 ml

	Ø cm	↑ cm	ltr.	Farbe / Colour	€
93140	9	30	0,7 / 0,4	stainless steel	14,80
93350	9	30	0,7 / 0,4	vintage look	15,30

Ersatzglas / spare glass / vaso de recambio / verre de rechange

	Ø cm	↑ cm	ltr.	€
93138	8,5	14,5	0,4	9,30



Boston Shaker
boston shaker
coctelera boston
shaker boston



2-teiliges Set: Becher, 700 ml + Glas, 400 ml

2 pcs.: beaker, 700 ml + glass, 400 ml

set de 2: vaso coctelero, 700 ml+ vaso vidrio 400 ml

set de 2: bol mélangeur, 700 ml + bol en verre 400 ml

	Ø cm	↑ cm	ltr.	Farbe / Colour	€
93325	9	30	0,7 / 0,4	vintage look copper	15,30
93201	9	30	0,7 / 0,4	copper look	15,30

Ersatzglas / spare glass / vaso de recambio / verre de rechange

	Ø cm	↑ cm	ltr.	€
93138	8,5	14,5	0,4	9,30



SHAKERS



36010

36011

Shaker „CLASSIC“

shaker
coctelera
shaker



3-teiliges Set: Edelstahlbecher, Siebaufsatz, Deckel, hochglanzpoliert

3 pieces: stainless steel mug, strainer, lid, mirror polished

set de 3: taza de acero inoxidable, colador, tapa, pulido brillante

set de 3: gobelet en acier inox, tamis, couvercle, poli brillant

	Ø cm	↑ cm	ltr.	Farbe / Colour	€
36010	8,5	20	0,5	stainless-steel	15,00
36011	9,0	23	0,7	stainless-steel	19,20



93211

93212

Shaker „CLASSIC“

shaker
coctelera
shaker



3-teiliges Set: Edelstahlbecher, Siebaufsatz, Deckel, hochglanzpoliert

3 pieces: stainless steel mug, strainer, lid mirror polished

set de 3: taza de acero inoxidable, colador, tapa, pulido brillante

set de 3: gobelet en acier inox, tamis, couvercle, poli brillant

	Ø cm	↑ cm	ltr.	Farbe / Colour	€
93211	8,5	20	0,5	copper-look	17,30
93212	9,0	23	0,7	copper-look	22,10



93366

Shaker „CLASSIC“

shaker
coctelera
shaker



3-teiliges Set: Edelstahlbecher, Siebaufsatz, Deckel

3 pieces: stainless steel mug, strainer, lid

set de 3: taza de acero inoxidable, colador, tapa

set de 3: gobelet en acier inox, tamis, couvercle

	Ø cm	↑ cm	ltr.	Farbe / Colour	€
93366	9,0	23	0,7	vintage-look	21,60



93326

Shaker „CLASSIC“

shaker
coctelera
shaker



3-teiliges Set: Edelstahlbecher, Siebaufsatz, Deckel

3 pieces: stainless steel mug, strainer, lid

set de 3: taza de acero inoxidable, colador, tapa

set de 3: gobelet en acier inox, tamis, couvercle

	Ø cm	↑ cm	ltr.	Farbe / Colour	€
93326	9,0	23	0,7	vintage-look copper	21,60

LIME AND LEMON SQUEEZERS



Limetten- / Zitronenpresse

lime- / lemon squeezer
exprimidor de limón & lima
presse-citron et citron vert

2 Pressringe für Zitrone und Limette

2 squeezing rings for lemon and lime

2 anillos exprimidores para limón y lima

2 anneaux à presser pour le citron et le lime



	cm	↑ cm	€
93214	21 x 7	5	14,60



Limettenpresse

lime squeezer
exprimidor de lima
presse-citron vert



	cm	↑ cm	€
93189	21 x 7	5	11,40



Zitruspresse

citrus squeezer
exprimidor cítricos
presse-citron

hochglanzpoliert, 2-teilig / mirror polished, 2 pcs. / pulido brillante, 2 piezas / poli brillant, 2 pièces



	Ø cm	↑ cm	ltr.	€
71431	12 / 17	10,5	0,35	13,80



Zitronenschnitzelpresse

lemon slice squeezer
pinza exprimelimón
pince presse citron

hochglanzpoliert, zum Auspressen von Zitronenscheiben / mirror polished, to press lemon slices / pulido brillante, para rodajas de limón / poli brillant, pour citrons en rondelle



	cm	€
71430	8 x 7	1,50



JIGGERS



Barmaß
jigger
medidor jigger
mesure double jigger



schnelles und genaues Abmessen von Spirituosen, mit Füllstrich
quick and exact measuring of spirits, with fill line
medida rápida y exacta de licores, con línea de llenado
mesure exact et rapide des spiritueux, avec ligne de remplissage

	Ø cm	↑ cm	cl.	Farbe / Colour		€
93351	4,5	9	1 / 2 / 3 / 4		stainless-steel-polished	7,60
93354	4,5	9	1 / 2 / 3 / 4		vintage-look	8,70



Barmaß
jigger
medidor jigger
mesure double jigger



schnelles und genaues Abmessen von Spirituosen, mit Füllstrich
quick and exact measuring of spirits, with fill line
medida rápida y exacta de licores, con línea de llenado
mesure exact et rapide des spiritueux, avec ligne de remplissage

	Ø cm	↑ cm	cl.	Farbe / Colour		€
93353	4,5	9	1 / 2 / 3 / 4		copper-look	10,90
93352	4,5	9	1 / 2 / 3 / 4		copper-antique	10,90



Barmaß
jigger
medidor jigger
mesure double jigger



schnelles und genaues Abmessen von Spirituosen, mit Füllstrich
quick and exact measuring of spirits, with fill line
medida rápida y exacta de licores, con línea de llenado
mesure exact et rapide des spiritueux, avec ligne de remplissage

	Ø cm	↑ cm	cl.	Farbe / Colour		€
93164	4,5	11,5	1,5 / 2,5 / 3,5 / 5		stainless-steel-polished	8,70
93355	4,5	11,5	1,5 / 2,5 / 3,5 / 5		vintage-look	9,80



Barmaß
jigger
medidor jigger
mesure double jigger



schnelles und genaues Abmessen von Spirituosen, mit Füllstrich
quick and exact measuring of spirits, with fill line
medida rápida y exacta de licores, con línea de llenado
mesure exact et rapide des spiritueux, avec ligne de remplissage

	Ø cm	↑ cm	cl.	Farbe / Colour		€
93165	4,5	11,5	1,5 / 2,5 / 3,5 / 5		copper-look	13,10
93324	4,5	11,5	1,5 / 2,5 / 3,5 / 5		copper-antique	13,10



Barmaß
jigger
medidor jigger
mesure double jigger



hochglanzpoliert, schnelles und genaues Abmessen von Spirituosen, mit Füllstrich
mirror polished, quick and exact measuring of spirits, with fill line
pulido brillante, medida rápida y exacta de licores, con línea de llenado
poli miroir, mesure exact et rapide des spiritueux, avec ligne de remplissage

	∅ cm	↑ cm	cl.	€
93356	4,5 / 5	9	1 / 1,5 / 2 / 3 / 4 / 6	13,10



Barmaß
jigger
medidor jigger
mesure double jigger



hochglanzpoliert, schnelles und genaues Abmessen von Spirituosen
mirror polished, quick and exact measuring of spirits, with fill line
pulido brillante, medida rápida y exacta de licores, con línea de llenado
poli miroir, mesure exact et rapide des spiritueux, avec ligne de remplissage

	∅ cm	↑ cm	cl.	€
93357	3,5	7,5	3 / 5	5,50



Barmaß
jigger
medidor jigger
mesure double jigger



hochglanzpoliert, schnelles und genaues Abmessen von Spirituosen, mit Füllstrich
mirror polished, quick and exact measuring of spirits, with fill line
pulido brillante, medida rápida y exacta de licores, con línea de llenado
poli miroir, mesure exact et rapide des spiritueux, avec ligne de remplissage

	∅ cm	↑ cm	cl.	€
93121	3,5 / 4,5	8,5	2 / 4	5,50
93112	4,0 / 4,5	8,5	2,5 / 5	5,90



Barmaß
jigger
medidor jigger
mesure double jigger



hochglanzpoliert, schnelles und genaues Abmessen von Spirituosen, mit Füllstrich
mirror polished, quick and exact measuring of spirits, with fill line
pulido brillante, medida rápida y exacta de licores, con línea de llenado
poli miroir, mesure exact et rapide des spiritueux, avec ligne de remplissage

	∅ cm	↑ cm	cl.	€
93120	4,0 / 4,5	7	1 / 2 / 3 / 4	5,10



Barmaß
jigger
medidor jigger
mesure double jigger



hochglanzpoliert, schnelles und genaues Abmessen von Spirituosen
mirror polished, quick and exact measuring of spirits, with fill line
pulido brillante, medida rápida y exacta de licores, con línea de llenado
poli miroir, mesure exact et rapide des spiritueux, avec ligne de remplissage

	∅ cm	↑ cm	cl.	€
93116	5 / 6	6	2 / 4	4,70



MUDDLERS



Stößel
muddler
mortero
pilon muddler



mit griffigem Ende, zum Auspressen von Früchten und Zerstoßen von Würfelzucker
with handy end, to press fruits or pound lump sugar
con un acabado en relieve para exprimir frutas y machacar azucarillos
avec relief grillagé pour presser les fruits ou le sucre en morceaux

	Ø cm	→ cm		Farbe / Colour	€
93358	3,5	20,5	stainless steel		7,20
93360	3,5	20,5	copper-look		9,20
93361	3,5	20,5	vintage-look		9,20
93362	3,5	20,5	copper-antique		9,20



Stößel
muddler
mortero
pilon muddler



grober Stößel, zum Auspressen von Früchten und Zerstoßen von Würfelzucker
coarse notched, to press fruits or pound lump sugar
mortero grueso con muescas para exprimir frutas y machacar azucarillos
muddler grand format avec bout relief étoile pour presser les fruits ou le sucre en morceaux

	Ø cm	→ cm		Farbe / Colour	€
93181	2,5	21			4,20
93182	4,0	24			8,60



Stößel
muddler
mortero
pilon muddler



aus Buchenholz, mit griffigem Ende, zum Auspressen von Früchten und Zerstoßen von Würfelzucker
beech wood, with handy end, to press fruits or pound lump sugar
madera de haya, acabado relieve para prensar frutas o azucar
bois de hêtre, avec relief grillagé pour presser les fruits ou le sucre en morceaux

	Ø cm	→ cm		Farbe / Colour	€
93180	2,5	21			3,80

BAR STRAINERS



Barsieb

bar strainer
colador de cóctel
tamis cocktail



Spiralfeder hält Eiswürfel beim Abseihen zurück, Feder kann zur Reinigung entnommen werden, passend für alle Gläser und Shaker

coil spring keeps ice cubes in shaker, spring can be taken off for cleaning, suitable for all glasses and shakers

con muelle para mantener los cubitos en la coctelera, el muelle se desmonta para limpiar, se adapta a todos los tipos de vasos y cocteleras

avec ressort pour garder les glaçons dans le shaker, ressort démontable pour lavage, s'adapte à tous types de verres mélangeurs et shakers

	Ø cm	Griff / handle cm	Farbe / Colour		€
93347	9	9		copper-antique	13,10
93348	9	9		copper-look	13,10
93349	9	9		vintage-look	13,10
93312	9	9		stainless steel	11,40



Einhandgebrauch
single-handed use



Barsieb

bar strainer
colador de cóctel
tamis cocktail



hochglanzpoliert, Spiralfeder hält Eiswürfel beim Abseihen zurück, Feder kann zur Reinigung entnommen werden, passend für alle Gläser und Shaker

mirror polished, coil spring keeps ice cubes in shaker, spring can be taken off for cleaning, suitable for all glasses and shakers

pulido brillante, con muelle para mantener los cubitos en la coctelera, el muelle se desmonta para limpiar, se adapta a todos los tipos de vasos y cocteleras

poli brillant, avec ressort pour garder les glaçons dans le shaker, ressort démontable pour lavage, s'adapte à tous types de verres mélangeurs et shakers

	Ø cm	Griff / handle cm	€
93300	8	6	5,50



Julep Barsieb „PRO“

julep strainer
colador de cóctel
tamis cocktail



hochglanzpoliert, Einhandgebrauch

mirror polished, single-handed use

pulido brillante, uso con una sola mano

poli brillant, utilisation d'une seule main



	Ø cm	Griff / handle cm	€
93313	7,5	9	9,80



BAR SPOONS



Barlöffel
bar spoon
cucharilla de cóctel
cuillère à cocktail



	→ cm	Farbe / Colour		€
93153	40		stainless steel	6,20
93129	44		stainless steel	9,80



Barlöffel
bar spoon
cucharilla de cóctel
cuillère à cocktail



	→ cm	Farbe / Colour		€
93134	27		stainless steel	5,90
93034	27		copper-look	8,60



Rührglas mit Lippe
mixing glass with lip
vaso mezclador vertedor con pico
verre mélangeur avec bec verseur



schwere Qualität
heavy quality
alta calidad
qualité renforcée

	Ø cm	↑ cm	ltr.	€
93141	9,0	16	0,5	11,40
93101	11,5	19	1,0	11,40



Bitterflasche / Spritzflasche

bitter bottle / dash bottle
botella / pulverizador licores
bouteille/pissette p. liqueurs



Behälter aus Glas, Ausgießer aus Kork und Edelstahl

container made of glass, cork pouring made of spout and stainless steel
recipiente de vidrio, pico de corcho y acero inox
bouteille d'huile et vinaigre

	Ø cm	↑ cm	ltr.	€
40512	5	15,5	0,1	5,60



Bitterflasche / Spritzflasche

bitter bottle / dash bottle
botella / pulverizador licores
bouteille/pissette p. liqueurs



Ausgießer aus Kork, Edelstahl, ideal für Bitterliköre

cork pouring spout, stainless steel, ideal for bitter liqueurs
pico de corcho, acero inox, ideal para licores amargos
bec verseur liège, acier inox, idéal pour les liqueurs amères

	cm	↑ cm	ltr.	€
93359	5 x 5	13	0,1	6,80



Dosier- & Vorratsflasche

pouring container
botella „store & pour“
bouteille „store & pour“



4-teilig: Behälter + Flaschenhals + Schraubdeckel + Ausgießer Ø 11 mm mit Luftzufuhr für gezieltes Ausgießen, zum Dosieren und Aufbewahren

4 pcs. set: for storage, mixing and serving drinks, nozzle Ø 11 mm
set de 4 piezas: para almacenar y servir mezclas y bebidas, agujero de Ø 11 mm
se compose de 4 pièces: idéal pour servir et pour conserver les boissons, embout Ø 11 mm

	Ø cm	↑ cm	ltr.	Farbe / Colour	€
93144	9	33	0,85		5,90
93145	9	33	0,85		5,90
93146	9	33	0,85		5,90
93147	9	33	0,85		5,90
93148	9	33	0,85		5,90



abnehmbarer Boden dient als Deckel
removable bottom serves as a lid

BAR STRAINERS



Barsieb
bar strainer
colador de cóctel
tamis cocktail



	Ø cm	↑ cm	Griff / handle cm	€
93318	8,5	5	11,5	4,50



Schneidebrett „BAR“
cutting board
table de corte
planche à découper



HDPE, mit Safrinne, mit Antirutschfüßchen
HDPE, with juice groove and non-slip feet
HDPE, con ranura para líquidos y pies antideslizantes
HDPE, avec rigole et pieds antidérapants

	cm	↑ cm	€
93306	30 x 20	2	28,40
93307	50 x 30	2	38,00



Cocktailmesser „TOOLTIME“
bar knife
cuchillo para cóctel
couteau cocktail



mit 2 Zinken zum Aufspießen von Zitrusseiben
with 2 prongs to pick up slices of lemon
con 2 dientes para pinchar las rodajas de limón, etc.
avec 2 dents pour les rondelles de citron et autres décorations

	→ cm	€
88846	21	4,80



Dekoriermesser „TOOLTIME“
decorating knife „canalé“
cuchillo acanalador
couteau cannelé



gezahnte Klinge aus geschärftem Edelstahl
serrated sharpened blade, stainless steel
hoja de sierra afilada, acero inoxidable
lame inox microdentée

	→ cm	€
88843	19	5,90



Zutatenbehälter
condiment holder
dispensador de especias
boîte à fruits et ingrédients



500 ml Inhalt pro Fach, 6 Fächer, inklusive Deckel (gefrostet) zur Lagerung
6 chambers á 500 ml, including lid for storing
6 compartimentos de 500 ml., incluye tapa para el almacenaje
6 compartiments de 500 ml chacun, avec couvercle pour le stockage

	cm	↑ cm	€
93171	50 x 16	10	23,50

Ersatzbehälter / replacement container / recipiente de recambio / récipient de remplacement

	cm	↑ cm	fits to	€
93176	14 x 7,5	7,5	93171	2,00



Bar Caddy

bar caddy
organizador de bar
organisateur „bar caddy“



Ordnungshilfe für Trinkhalme, Rührer, Servietten, Streichhölzer, etc.

to organize straws, stirrers, napkins, matches, etc.
para organizar pajitas, cucharillas, servilletas, cerillas, etc.
pour bien organiser les pailles, agitateurs, cuillers, serviettes et autres accessoires

	cm	↑ cm	€
93174	24 x 15	11	8,80



Glasumrander

glass rimmer
ribeteador de vasos
bordeur à verres „rimmer“



Schwamm für Limettensaft, 2 Fächer für Zucker und Salz

with sponge for lime juice, 2 cases for sugar and salt
con esponja para zumo de lima, 2 compartimentos para azucar y sal
avec éponge et 2 compartiments pour sucre et sel

	cm	€
93175	20 x 7,5	10,40

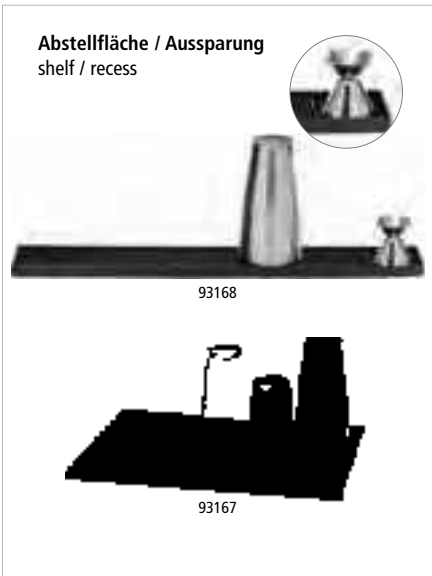

Abstellfläche / Aussparung
shelf / recess



Barmatte

drip mat
tapete escurridor
tapis de bar



aus weichem Kunststoff, zum Abtropfen von Gläsern etc.

soft plastic, to store and drain glasses
plástico blando para escurrir vasos
plastique souple, pour l'égouttage des verres

	cm	↑ cm		€
93168	60 x 8	1	mit Vertiefung	10,00
93166	30 x 15	1	ohne Vertiefung	7,60
93173	52 x 8	1	ohne Vertiefung	9,40
93169	60 x 8	1	ohne Vertiefung	10,00
93167	45 x 31	1	ohne Vertiefung	20,60

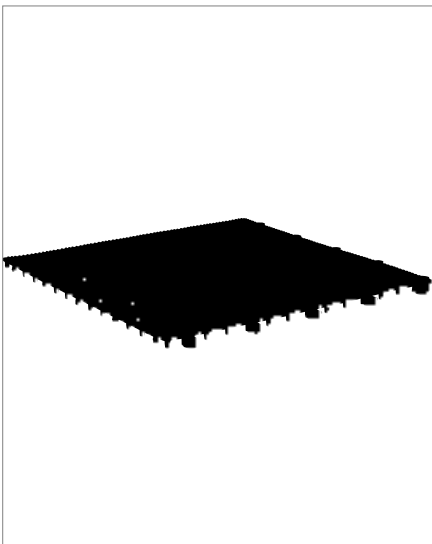

Abtropfmatte

drip mat
esterilla escurridora
tapis égouttoir



erweiterbar durch Klick-Verbindung

expandable
las placas de fijan con clips
avec clips de fixation

	cm	↑ cm	€
93303	33 x 33	1,5	6,40



POURERS



Permanent-Ausgießer, 6er Set
 free flow pourer, 6 pcs.
 vertedor continuos set 6 piezas
 set de 6 bouchons verseurs continus



	↑ cm	pcs.	€ / set
93110	11	6	14,00



Sekt-Verschluss, 2er Set

stopper, 2 pcs.
 set de 2 tapones
 set de 2 bouchons



matt poliert, innen Gummi Arabicum
 matt polished, inside rubber arabicum, with inscription
 pulido mate, interior goma arábica con inscripción
 poli maté, intérieur gomme arabique

	∅ cm	↑ cm	pcs.	€ / set
93160	4	5,5	2	8,90



Permanent-Ausgießer, 6er Set

free flow pourer, 6 pcs.
 vertedor continuos set 6 piezas
 set de 6 bouchons verseurs continus



à 2 Stück: blau, rot, gelb
 2 pcs of each colour: blue, red, yellow
 2 piezas de cada color: azul, rojo, amarillo
 2 par couleur: bleu, rouge, jaune

	∅ cm	↑ cm	pcs.	€ / set
93111	3	7,5	6	5,60



Reinigungsbürste für Ausgießer

pourer cleaning brush
 cepillo de limpieza para picos vertedores
 brosse lave-bouchons doseurs



	→ cm	€
93102	16,5	2,80



Staubkappen, 2er Set

dust & fly cap, 2 pcs.
 tapón antipolvo
 bouchon anti-poussières et anti-insectes



schützt vor Staub und Insekten
 protects for dust and insects
 para proteger de la suciedad e insectos
 pour protéger de la poussière et des insectes

	∅ cm	↑ cm	pcs.	€ / set
93161	4	8	2	4,90

STRAWS



Trinkhalme 11er Set

straws, 11 pcs. set
pajas, set de 11 pz.
pailles, set de 11 pc.



11-teiliges Set: 10 Trinkhalme aus Edelstahl + Reinigungsbürste

11 pcs. set: 10 drinking straws made of stainless steel + cleaning brush

set de 11: 10 pajas de acero inoxidable + cepillo de limpieza

set de 11: 10 pailles en acier inox + brosse de nettoyage

	Ø mm	→ cm	Farbe / Colour	€ / set
93391	8	15,0		copper-look 11,40
93392	8	15,0		gunmetal-look 11,40
93393	8	15,0		rainbow-look 11,40
93383	8	21,5		copper-look 13,20
93384	8	21,5		gunmetal-look 13,20
93385	8	21,5		rainbow-look 13,20

Ersatzbürste / replacement brush / cepillo de recambio / brosse de rechange

	Ø mm	→ cm	€
93395	8	15	1,30
93386	8	20	2,60



Trinkhalme 7er Set

straws, 7 pcs. set
pajas, set de 7 pz.
pailles, set de 7 pc.



	Ø mm	→ cm	pcs.	€ / set
93394	10	15	7	7,00
93390	10	21	7	8,00



MOSCOW MULE



Becher „MOSCOW MULE“

barrel copper mug
taza
gobelet



Edelstahlbecher, gehämmert, Kupfer-Look, hochglanzpoliert
stainless steel cup, hammered, copper look, mirror polished
taza de acero inoxidable, martillada, estilo cobre, pulido brillante
gobelet en acier inox, martelée, aspect cuivre, poli brillant

	Ø cm	↑ cm	ltr.	Farbe / Colour	€
93311	9	10	0,5	copper-hammered	11,80



Becher „MOSCOW MULE“

barrel copper mug
taza
gobelet



Edelstahlbecher, gehämmert, Antik-Kupfer-Look
stainless steel cup, hammered, copper look
taza de acero inoxidable, martillada, cobre estilo antiguo
gobelet en acier inox, martelée, cuivre style antique

	Ø cm	↑ cm	ltr.	Farbe / Colour	€
93323	9	10	0,5	copper-antique-hammered	11,80

Becher „MOSCOW MULE“, 2er-Set / barrel copper mug, 2 pcs. / taza, set de 2 / gobelet, set de 2

	Ø cm	↑ cm	ltr.	Farbe / Colour	pcs.	€ / set
93367	9	10	0,5	copper-antique-hammered	2	23,20



Becher „MOSCOW MULE“

barrel mug
taza
gobelet



Edelstahlbecher, gehämmert, Vintage-Look
stainless steel cup, hammered
taza de acero inoxidable, martillada
gobelet en acier inox, martelée

	Ø cm	↑ cm	ltr.	Farbe / Colour	€
93346	9	10	0,5	vintage-look	11,80

**Becher „MOSCOW MULE“**

barrel copper mug

taza

gobelet

Edelstahlbecher, Kupfer-Look, hochglanzpoliert

stainless steel cup, copper look, mirror polished

taza de acero inoxidable, estilo cobre, pulido brillante

gobelet en acier inox, aspect cuivre, poli brillant



	Ø cm	↑ cm	ltr.	Farbe / Colour	€
93310	9	9	0,45	 copper-look	11,80

**Becher „MOSCOW MULE“**

barrel copper mug

taza

gobelet

Edelstahlbecher, Antik-Kupfer-Look

stainless steel cup, copper antique look

taza de acero inoxidable, cobre estilo antiguo

gobelet en acier inox, cuivre style antique



	Ø cm	↑ cm	ltr.	Farbe / Colour	€
93322	9	9	0,45	 copper-antique	11,80

**Becher „MOSCOW MULE“**

barrel mug

taza

gobelet

Edelstahlbecher, Vintage-Look

stainless steel cup

taza de acero inoxidable

gobelet en acier inox



	Ø cm	↑ cm	ltr.	Farbe / Colour	€
93345	9	9	0,45	 vintage-look	11,80



MOSCOW MULE

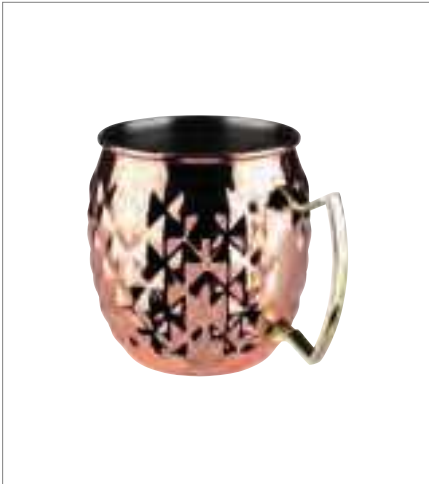

Becher „MOSCOW MULE“

barrel copper mug

taza

gobelet

Edelstahlbecher, Kupfer-Look, hochglanzpoliert

stainless steel cup, copper look, mirror polished

taza de acero inoxidable, estilo cobre, pulido brillante

gobelet en acier inox, aspect cuivre, poli brillant



	Ø cm	↑ cm	litr.	Farbe / Colour		€
93332	9,5	10	0,50		copper-look	11,80



Becher „MOSCOW MULE“

barrel copper mug

taza

gobelet

Edelstahlbecher, Antik-Kupfer-Look

stainless steel cup, copper antique look

taza de acero inoxidable, cobre estilo antiguo

gobelet en acier inox, cuivre style antique



	Ø cm	↑ cm	litr.	Farbe / Colour		€
93331	9,5	10	0,50		copper-antique	11,80



Becher „MOSCOW MULE“

barrel mug

taza

gobelet

Edelstahlbecher, Vintage-Look

stainless steel cup

taza de acero inoxidable

gobelet en acier inox



	Ø cm	↑ cm	litr.	Farbe / Colour		€
93333	9,5	10	0,50		vintage-look	11,80



PINEAPPLE



mit Deckel
with lid
ohne Strohalm
without straw

Becher „PINEAPPLE“

barrel mug
taza
gobelet

Glasbecher mit Edelstahl Deckel
glass cup with stainless steel lid
taza de cristal con tapa en acero inoxidable
gobelet en verre avec couvercle en acier inox



	Ø cm	↑ cm	ltr.	€
93375	8,5	17,5	0,35	18,50



mit Deckel
with lid
ohne Strohalm
without straw

Becher „PINEAPPLE“

barrel mug
taza
gobelet

Edelstahlbecher, Kupfer-Look
stainless steel cup, copper look
taza de acero inoxidable, cobre
gobelet en acier inox, cuivre



	Ø cm	↑ cm	ltr.	Farbe / Colour	€
93334	9	19	0,5	 copper-look	22,90



mit Deckel
with lid
ohne Strohalm
without straw

Becher „PINEAPPLE“

barrel mug
taza
gobelet

Edelstahlbecher, Gold-Look
stainless steel cup, gold look
taza de acero inoxidable, dorada
gobelet en acier inox, doré



	Ø cm	↑ cm	ltr.	Farbe / Colour	€
93335	9	19	0,5	 gold-look	22,90

JULEP MUGS



Becher „JULEP MUG“

barrel mug

taza

gobelet



	Ø cm	↑ cm	ltr.	Farbe / Colour	€
93337	8	11,5	0,40	 copper hammered	12,80



Becher „JULEP MUG“

barrel mug

taza

gobelet



	Ø cm	↑ cm	ltr.	Farbe / Colour	€
93336	8	11,5	0,40	 copper-antique-hammered	12,80



Becher „JULEP MUG“

barrel mug

taza

gobelet



	Ø cm	↑ cm	ltr.	Farbe / Colour	€
93338	8	11,5	0,40	 vintage-look	12,80



Becher „JULEP MUG“
barrel mug
taza
gobelet



	Ø cm	↑ cm	ltr.	Farbe / Colour	€
93328	8,5	10	0,35	 copper-look	12,80



Becher „JULEP MUG“
barrel mug
taza
gobelet



	Ø cm	↑ cm	ltr.	Farbe / Colour	€
93327	8,5	10	0,35	 copper-antique	12,80



Becher „JULEP MUG“
barrel mug
taza
gobelet



	Ø cm	↑ cm	ltr.	Farbe / Colour	€
93329	8,5	10	0,35	 stainless	12,80



MUGS



Becher „COOL“

barrel mug
taza
gobelet



Edelstahlbecher, gehämmert, Kupfer-Look, hochglanzpoliert

stainless steel cup, hammered, copper look, mirror polished
taza de acero inoxidable, martillada, estilo cobre, pulido brillante
gobelet en acier inox, martelée, aspect cuivre, poli brillant

	Ø cm	↑ cm	ltr.	Farbe / Colour	€
93371	7,5	10,5	0,35		copper-look 9,90



Becher „COOL“

barrel mug
taza
gobelet



Edelstahlbecher, gehämmert, Vintage-Look

stainless steel cup, hammered
taza de acero inoxidable, martillada
gobelet en acier inox, martelée

	Ø cm	↑ cm	ltr.	Farbe / Colour	€
93373	7,5	10,5	0,35		vintage-look 9,90



Becher „COOL“

barrel mug
taza
gobelet



Edelstahlbecher, gehämmert, Gunmetal-Look, hochglanzpoliert

stainless steel cup, hammered, gunmetal look, mirror polished
taza de acero inoxidable, martillada, estilo gunmetal, pulido brillante
gobelet en acier inox, martelée, aspect gunmetal, poli brillant

	Ø cm	↑ cm	ltr.	Farbe / Colour	€
93372	7,5	10,5	0,35		gunmetal-look 9,90



Becher „COOL“

barrel mug
taza
gobelet



Edelstahlbecher, Regenbogen-Look

stainless steel cup, rainbow look
taza de acero inoxidable, estilo arco iris
gobelet en acier inox, look arc-en-ciel

	Ø cm	↑ cm	ltr.	Farbe / Colour	€
93374	7,5	10,5	0,35		rainbow-look 9,90



Speedshaker / Trinkbecher

speed shaker / drinking cup
agitador rápido / vaso
speedshaker / gobelet



	Ø cm	↑ cm	ltr.	€
93204	8,5	13	0,5	8,00



Becher „BEER MUG“

barrel mug
taza
gobelet



	Ø cm	↑ cm	ltr.	Farbe / Colour	€
93364	8,5	13	0,50	copper-antique	15,40
93365	8,5	13	0,50	vintage-look	15,40



Snackspender „NOTOUCH“

snack dispenser
dispensador de snacks
distributeur de snacks



Behälter aus Glas, Schraubdeckel aus Edelstahl, Öffnung oval 3,5 x 2,5 cm
glass container, stainless steel screw cap, opening oval 3,5 x 2,5 cm
recipiente de cristal, tapón de rosca de acero inoxidable, apertura ovalada 3,5 x 2,5 cm
récipient en verre, couvercle à visser en acier inox, ouverture ovale 3,5 x 2,5 cm

	Ø cm	↑ cm	ltr.	Farbe / Colour	€
40516	8,5	15,5	0,35	gold-look	8,40
40517	8,5	15,5	0,35	gunmetal-look	8,40

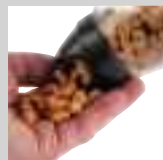

Gläserchiene

glass rack
rack de copas
rack porte-verres



aus 6 mm Draht, Metall verchromt, Wand- und Deckenmontage möglich
6 mm chrome plated wire, can be mounted under a shelf or on the wall
alambre cromado de 6 mm, puede instalarse bajo una estantería o en la pared
fil chromé de 6 mm, à installer sous une étagère ou contre un mur

	cm	↑ cm	Farbe / Colour	for glasses	€
93398	29,5 x 32	6	chrome	12	25,00
93399	29,5 x 32	6	black	12	25,00
93400	45,0 x 32	6	chrome	20	34,00

LINEA



10574

5 SIZES
4 COLOURS



150 ml

10570



220 ml

10566



300 ml

10572



400 ml

10568



500 ml

10574

Trinkglas „LINEA“ drinking glass vaso de agua verre à boire



facettiertes Liniendesign, vielseitig einsetzbar, robustes, unzerbrechliches Material, ideal in sensiblen Bereichen wie Pool, Spa, Beach und Wellness einzusetzen

faceted line design, can be used in versatile ways, a solide and unbreakable material, ideal to be used at pool, spa, beach and wellness areas

diseño de líneas facetadas, se pueden utilizar de muchas maneras diferentes, material sólido e irrompible, ideal para el uso en áreas como piscina, spa, playa y bienestar
design de ligne à facettes, peuvent être utilisés de différentes façons, matériau robuste et incassable, idéal pour une utilisation dans des zones comme la piscine, le spa, la plage et le bien-être

	Ø cm	↑ cm	ltr.	Farbe / Colour	VE	€/ pc.
10570	6,5	8	0,15	light green	48	2,60
10571	8,5	8	0,22	light green	48	2,90
10572	8,5	10	0,30	light green	48	3,40
10573	8,5	12	0,40	light green	48	3,80
10574	8,5	15	0,50	light green	48	4,20

	Ø cm	↑ cm	ltr.	Farbe / Colour	VE	€/ pc.
10565	6,5	8	0,15	french grey	48	2,60
10566	8,5	8	0,22	french grey	48	2,90
10567	8,5	10	0,30	french grey	48	3,40
10568	8,5	12	0,40	french grey	48	3,80
10569	8,5	15	0,50	french grey	48	4,20



UNZERBRECHLICH
UNBREAKABLE



Trinkglas „LINEA“

drinking glass
vaso de agua
verre à boire



facettiertes Liniendesign, vielseitig einsetzbar, robustes, unzerbrechliches Material, ideal in sensiblen Bereichen wie Pool, Spa, Beach und Wellness einzusetzen

faceted line design, can be used in versatile ways, a solide and unbreakable material, ideal to be used at pool, spa, beach and wellness areas

diseño de líneas facetadas, se pueden utilizar de muchas maneras diferentes, material sólido e irrompible, ideal para el uso en áreas como piscina, spa, playa y bienestar
design de ligne à facettes, peuvent être utilisés de différentes façons, matériau robuste et incassable, idéal pour une utilisation dans des zones comme la piscine, le spa, la plage et le bien-être

	Ø cm	↑ cm	ltr.	Farbe / Colour	VE	€/ pc.
10585	6,5	8	0,15	light blue	48	2,60
10586	8,5	8	0,22	light blue	48	2,90
10587	8,5	10	0,30	light blue	48	3,40
10588	8,5	12	0,40	light blue	48	3,80
10589	8,5	15	0,50	light blue	48	4,20
	Ø cm	↑ cm	ltr.	Farbe / Colour	VE	€/ pc.
10560	6,5	8	0,15	crystal clear	48	2,50
10561	8,5	8	0,22	crystal clear	48	2,80
10562	8,5	10	0,30	crystal clear	48	3,30
10563	8,5	12	0,40	crystal clear	48	3,70
10564	8,5	15	0,50	crystal clear	48	4,10



UNZERBRECHLICH
UNBREAKABLE



CRYSTAL



3 SIZES
3 COLOURS



Trinkglas „CRYSTAL“
drinking glass
vaso de agua
verre à boire



Kristallglas-Optik, vielseitig einsetzbar, robustes, unzerbrechliches Material, ideal in sensiblen Bereichen wie Pool, Spa, Beach und Wellness einzusetzen
crystal-glass-look, can be used in versatile ways, a solide and unbreakable material, ideal to be used at pool, spa, beach and wellness areas

aspecto vidrio, se pueden utilizar de muchas maneras diferentes, material sólido e irrompible, ideal para el uso en áreas como piscina, spa, playa y bienestar
ressemble à un verre de cristal, peuvent être utilisés de différentes façons, matériau robuste et incassable, idéal pour une utilisation dans des zones comme la piscine, le spa, la plage et le bien-être

	Ø cm	↑ cm	ltr.	Farbe / Colour	VE	€/ pc.
10510	7	9,5	0,15	red star	48	3,20
10511	8	12,5	0,30	red star	48	4,30
10512	9	15,5	0,50	red star	48	5,30
	Ø cm	↑ cm	ltr.	Farbe / Colour	VE	€/ pc.
10534	7	9,5	0,15	green	48	3,20
10535	8	12,5	0,30	green	48	4,30
10536	9	15,5	0,50	green	48	5,30
	Ø cm	↑ cm	ltr.	Farbe / Colour	VE	€/ pc.
10525	7	9,5	0,15	french grey	48	3,20
10526	8	12,5	0,30	french grey	48	4,30
10527	9	15,5	0,50	french grey	48	5,30



UNZERBRECHLICH
UNBREAKABLE

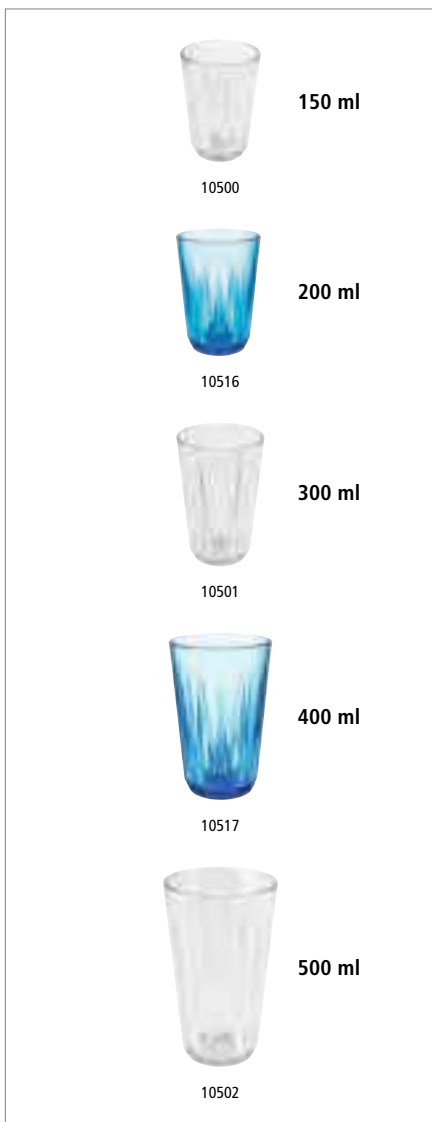

Trinkglas „CRYSTAL“

drinking glass
vaso de agua
verre à boire



Kristallglas-Optik, vielseitig einsetzbar, robustes, unzerbrechliches Material, ideal in sensiblen Bereichen wie Pool, Spa, Beach und Wellness einzusetzen

crystal-glass-look, can be used in versatile ways, a solide and unbreakable material, ideal to be used at pool, spa, beach and wellness areas

aspecto vidrio, se pueden utilizar de muchas maneras diferentes, material sólido e irrompible, ideal para el uso en áreas como piscina, spa, playa y bienestar

ressemble à un verre de cristal, peuvent être utilisés de différentes façons, matériau robuste et incassable, idéal pour une utilisation dans des zones comme la piscine, le spa, la plage et le bien-être

	Ø cm	↑ cm	ltr.	Farbe / Colour	VE	€/ pc.
10500	7,0	9,5	0,15		48	3,10
10503	7,5	11,0	0,20		48	3,50
10501	8,0	12,5	0,30		48	4,20
10504	8,5	14,0	0,40		48	4,60
10502	9,0	15,5	0,50		48	5,20
	Ø cm	↑ cm	ltr.	Farbe / Colour	VE	€/ pc.
10513	7,0	9,5	0,15		48	3,20
10516	7,5	11,0	0,20		48	3,60
10514	8,0	12,5	0,30		48	4,30
10517	8,5	14,0	0,40		48	4,70
10515	9,0	15,5	0,50		48	5,30



UNZERBRECHLICH
UNBREAKABLE



5 SIZES
2 COLOURS

PERFECTION



UNZERBRECHLICH
UNBREAKABLE



Trinkglas „PERFECTION“

drinking glass
vaso de agua
verre à boire



	Ø cm	↑ cm	ltr.	VE / unit	€ / pc.
10543	8	11,5	0,33	12	6,60



Trinkglas „PERFECTION“

drinking glass
vaso de agua
verre à boire



	Ø cm	↑ cm	ltr.	VE / unit	€ / pc.
10544	8	15	0,47	12	7,40



Sektglas „PERFECTION“

champagne glasses
copa de champán
flûte à champagne



	Ø cm	↑ cm	ltr.	VE / unit	€ / pc.
10540	5	23	0,19	12	6,40



Weißweinglas „PERFECTION“

white wine glasses
copa de vino blanco
verre à vin blanc



	Ø cm	↑ cm	ltr.	VE / unit	€ / pc.
10541	8	21,5	0,32	12	7,60



Rotweinglas „PERFECTION“

red wine glasses
copa de vino tinto
verre à vin rouge



	Ø cm	↑ cm	ltr.	VE / unit	€ / pc.
10542	10,5	21	0,6	12	8,60

SUPER CUP



Becher mit Deckel, 8er Set „SUPER CUP“

mug with lid, 8 pcs.
 taza con tapa, set de 8
 gobelet avec couvercle, set de 8

Set bestehend aus 8 Bechern + 8 Deckeln

set consists of 8 mugs + 8 lids
 set compuesto por 8 tazas + 8 tapas
 set de 8 gobelets + 8 couvercles



	Ø cm	↑ cm	ltr.	Farbe / Colour	pcs.	€/ set
10506	8	10	0,25	transparent	8	19,00



mit Stapelnocke
 with stacking cam



rutschfester Deckel
 non-slip lid

NEW



Tasse „TEATIME“

mug
 taza
 tasse



transparent mattiert, ideal in sensiblen Bereichen wie Pool, Spa, Beach und Wellness einzusetzen
 transparent frosted, ideal to be used at pool, spa, beach and wellness areas
 transparente esmerilado, ideal para el uso en áreas como piscina, spa, playa y bienestar
 transparent mat, idéal pour une utilisation dans des zones comme la piscine, le spa, la plage et le bien-être

	Ø cm	↑ cm	ltr.	Farbe / Colour	VE / unit	€/ pc.
66940	8,5	9	0,25	transparent	24	3,90



TO GO



Mehrwegbecher „TO GO“
 reusable cup
 vaso reutilizable
 tasse réutilisable



Becher (ohne Deckel), Rillendesign isoliert die Hitze ohne die Handflächen zu verbrennen
 cup (without cover), grooved design insulates the heat without burning your hands
 vaso (sin tapa), el diseño acanalado aísla el calor sin quemarte las manos
 tasse (sans couvercle), le design rainuré isole la chaleur sans brûler les mains

	Ø cm	↑ cm	ltr.	Farbe / Colour	VE / unit	€ / pc.
66911	8,5	13,5	0,4		48	2,20
66912	8,5	13,5	0,4		48	2,20
66913	8,5	13,5	0,4		48	2,20

Deckel / cover / tapa / couvercle

	Ø cm	↑ cm	Farbe / Colour	VE / unit	€ / pc.
66915	8,5	2,5		48	1,10
66916	8,5	2,5		48	1,10
66917	8,5	2,5		48	1,10

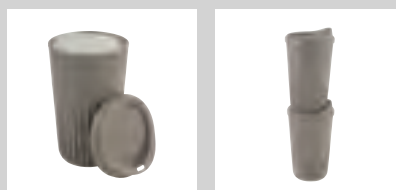

BRANDING

Gerne bieten wir eine individuelle Gestaltung an.

We are happy to offer an individual design.



1 Deckel | cover

Ø 8,5 cm | H 2,5 cm

1,10 € / Stück (brutto) | pcs. (gross)

2 Becher, ohne Druck | cup, without print

Ø 8,5 cm | H 13,5 cm

2,20 € / Stück (brutto) | pcs. (gross)

sofort verfügbar | immediately available



3 1-farbiger Druck | 1-colour print

1,15 € / Stück (netto) | pcs. (net) | (MOQ 500)

1,00 € / Stück (netto) | pcs. (net) | (MOQ 1.000)

4 2-farbiger Druck | 2-colour print

1,35 € / Stück (netto) | pcs. (net) | (MOQ 500)

1,15 € / Stück (netto) | pcs. (net) | (MOQ 1.000)

5 4-farbiger Druck | 4-colour print

2,20 € / Stück (netto) | pcs. (net) | (MOQ 500)

2,00 € / Stück (netto) | pcs. (net) | (MOQ 1.000)

6 Relief / Prägung | relief / embossing

0,45 € / Stück (netto) | pcs. (net) | (MOQ 1.000)

3-4 Wochen | 3-4 weeks delivery time

8 Wochen | 8 weeks delivery time

Druckvorlagen sollten als Vektorgrafik angeliefert werden. Der Druck wird anschließend eingebrannt, sodass der Becher weiterhin spülmaschinengeeignet ist.

Artwork should be supplied as a vector graphic. The print is then burned in so that the cup is still dishwasher-safe.

- ✓ aufsteckbarer Deckel mit Trinköffnung
clip-on lid with drinking opening
- ✓ 100 % recyclebar
100 % recyclable
- ✓ spülmaschinengeeignet
dishwasher safe
- ✓ stapelbar mit und ohne Deckel
stackable with and without lid
- ✓ schwappsiche
slosh-/leak-proof



SNUG



Espressotasse „SNUG“

espresso cup
taza de espresso
tasse à espresso



Porzellan, Griff: 2 cm / porcelain, handle: 2 cm / porcelana, asa: 2 cm / porcelaine, poignée: 2 cm

	Ø cm	↑ cm	litr.	Farbe / Colour	VE / unit	€/ pc.
16000	6	5,5	0,08		6	2,90
16001	6	5,5	0,08		6	2,90
16002	6	5,5	0,08		6	2,90



Espresso-untertasse „SNUG“

espresso saucer
platillo de espresso
soucoupe à espresso



Porzellan / porcelain / porcelana / porcelaine

	Ø cm	↑ cm		Farbe / Colour	VE / unit	€/ pc.
16009	11,5	2			6	2,80
16010	11,5	2			6	2,80
16011	11,5	2			6	2,80





Kaffeetasse „SNUG“

coffee cup
taza de café
tasse à café



Porzellan, Griff: 2 cm / porcelain, handle: 2 cm / porcelana, asa: 2 cm / porcelaine, poignée: 2 cm

	Ø cm	↑ cm	ltr.	Farbe / Colour	VE / unit	€ / pc.
16003	9,5	6	0,2		6	4,30
16004	9,5	6	0,2		6	4,30
16005	9,5	6	0,2		6	4,30



Kaffeuntertasse „SNUG“

coffee saucer
plattilo de café
soucoupe à café



Porzellan / porcelain / porcelana / porcelaine

	Ø cm	↑ cm		Farbe / Colour	VE / unit	€ / pc.
16012	14,5	2,5			6	3,40
16013	14,5	2,5			6	3,40
16014	14,5	2,5			6	3,40



Cappuccinotasse „SNUG“

cappuccino cup
taza de cappuccino
tasse à cappuccino



Porzellan, Griff: 3 cm / porcelain, handle: 3 cm / porcelana, asa: 3 cm / porcelaine, poignée: 3 cm

	Ø cm	↑ cm	ltr.	Farbe / Colour	VE / unit	€ / pc.
16006	10,5	6,5	0,3		6	5,90
16007	10,5	6,5	0,3		6	5,90
16008	10,5	6,5	0,3		6	5,90



Cappuccinountertasse „SNUG“

cappuccino saucer
plattilo de cappuccino
soucoupe cappuccino



Porzellan / porcelain / porcelana / porcelaine

	Ø cm	↑ cm		Farbe / Colour	VE / unit	€ / pc.
16015	15,5	2,5			6	3,80
16016	15,5	2,5			6	3,80
16017	15,5	2,5			6	3,80

TEAPOTS



Teekanne „ASIA“

teapot
tetera
théière



aus Gusseisen, innen emailliert, abnehmbarer Deckel, mit Teesieb aus Edelstahl

made of cast iron, enamelled inside, removable lid, with tea strainer made of stainless steel
hierro fundido, interior esmaltado, tapa extraíble, con colador de té de acero inoxidable
en fonte, émaillé à l'intérieur, couvercle amovible, avec une passoire à thé en acier inox

	cm	↑ cm	ltr.	Farbe / Colour	€
10995	17 x 14	17	0,8	■	26,00
10996	17 x 14	17	0,8	■	26,00



Teekanne „ASIA“

teapot
tetera
théière



aus Gusseisen, innen emailliert, abnehmbarer Deckel, mit Teesieb aus Edelstahl

made of cast iron, enamelled inside, removable lid, with tea strainer made of stainless steel
hierro fundido, interior esmaltado, tapa extraíble, con colador de té de acero inoxidable
en fonte, émaillé à l'intérieur, couvercle amovible, avec une passoire à thé en acier inox

	cm	↑ cm	ltr.	Farbe / Colour	€
10991	19,5 x 18	15	0,8	■	26,00
10992	19,5 x 18	15	0,8	■	26,00



Teekanne „ASIA“

teapot
tetera
théière



aus Gusseisen, innen emailliert, mit abnehmbarem Deckel, ohne Teesieb aus Edelstahl
made of cast iron, enamelled inside, with removable lid, without tea strainer made of stainless steel

hierro fundido, interior esmaltado, con tapa extraíble, sin colador de té de acero inoxidable
en fonte, émaillé à l'intérieur, avec couvercle amovible, sans une passoire à thé en acier inox

	cm	↑ cm	ltr.	Farbe / Colour	€
10990	12,5 x 11	12,5	0,3	■	21,00

**Stövchen „ASIA“**

teapot warmer
calentador de tetera
chauffe-théière



1-flammiges Stövchen aus Gusseisen mit abnehmbarem Deckel (Lieferung ohne Teelicht).

1-flame cast iron warmer with removable lid (delivery without tealight).

calentador de tetera de hierro fundido con 1 quemador con tapa extraíble (se entrega sin vela).

chauffe-théière en fonte à 1 brûleur avec couvercle amovible (livraison sans bougie).

	Ø cm	↑ cm	€
10994	13	7,5	16,40

Untersetzer aus Gusseisen mit Antirutschfüßchen / cast iron coaster with non-slip feet

	Ø cm	↑ cm	€
10993	13,5	1,5	5,50

**Teebox**

tea-box
caja para té
boîte à thés et infusions



Box aus Rubberwood mit Sichtfenster, mit Aufschrift „Tee“, 4 Kammern können mit je 30 kuvertierten Teebeuteln bestückt werden

rubber wood box with clear transparent window, with inscription „Tee“, 4 chambers for approx. 30 tea bags each

caja de madera de goma clara con ventana transparente, con inscripción „Tee“, 4 compartimentos, y cada uno para aproximadamente 30 bolsitas de té en bois d'hévéa clair avec fenêtre, avec inscription „Tee“, 4 compartiments, pour environ 30 sachets chacun

	cm	↑ cm	Farbe / Colour	€
11575	33,5 x 20	9	light	21,00
11574	33,5 x 20	9	dark	21,00

	cm	↑ cm	Farbe / Colour	€
11576	33,5 x 20	9	light	21,00

ohne Aufschrift / without inscription
sin inscripción / sans inscription

**Teebox**

tea-box
caja para té
boîte à thés et infusions



Box aus Rubberwood mit Sichtfenster, mit Aufschrift „Tee“, 12 Kammern können mit je 12 kuvertierten Teebeuteln bestückt werden

rubber wood box with clear transparent window, with inscription „Tee“, 12 chambers for approx. 12 tea bags each

caja de madera de goma clara con ventana transparente, con inscripción „Tee“, 12 compartimentos, y cada uno para aproximadamente 12 bolsitas de té en bois d'hévéa clair avec fenêtre, avec inscription „Tee“, 12 compartiments, pour environ 12 sachets chacun

	cm	↑ cm	Farbe / Colour	€
11775	31 x 28	9	light	28,00
11776	31 x 28	9	dark	28,00

**Teebox / Multibox**

tea caddy
caja para té
boîte à thés et infusions



3 Fächer für kuvertierte Teebeutel, 1 Fach für Zucker, Kekse, etc., Deckel aufklappbar

3 compartments for tea bags, 1 compartment for sugar, biscuits, etc., hinged lid

3 compartimentos para bolsitas de té, 1 compartimento para azúcar, galletas, etc. tapa abatible

3 compartiments pour sachets de thé, 1 compartiment pour sucre, biscuits, etc., couvercle abatible

	cm	↑ cm	€
11563	22 x 17	9	21,00



H²O YEAH



Trinkflasche „H²O YEAH“

drinking bottle
cantimplora
gourde

EDELSTAHL
STAINLESS
INOX
18/8

BAMBUS
BAMBOO

die doppelwandige Vakuumflasche aus Edelstahl hält Heißes 12 Stunden heiß und Kaltes 24 Stunden kalt, 100% auslaufsicher

the double-walled stainless steel vaccum bottle keeps hot drinks hot for 12 hours and cold drinks cold for 24 hours, 100% leak proof

la cantimplora al vacío de acero inoxidable de doble pared mantiene las bebidas calientes durante 12 horas y las frías durante 24 horas, 100% transporte sin salpicaduras

la gourde à vide en acier inoxydable à double paroi permet de conserver les boissons chaudes pendant 12 heures et les boissons froides pendant 24 heures, 100% transport sans éclaboussures

	Ø cm	↑ cm	ltr.	€
66905	7,5	24,5	0,5	11,00
66906	7,5	29,5	0,75	13,60



mit Schraubverschluss
with screw cap

inkl. Ersatzdichtung
incl. spare gasket

EVERFILL



Trinkflasche „EVERFILL“

drinking bottle
botella para beber
gourde

Glas mit Schraubverschluss aus Edelstahl
screw cap made of stainless steel
tapón de rosca de acero inoxidable
bouchon à vis en acier inox



	Ø cm	↑ cm	ltr.	€
66907	6,5	23,5	0,55	5,00
66908	7,0	26,5	0,75	6,10
66909	7,5	28,5	1,0	7,20



mit Schraubverschluss
with screw cap

BARISTA



Milch-/Universalkanne

non stick jug
jarra antiadherente
pichet antiadhésif

Antihafbeschichtet, perfekt für die Herstellung von Milchschaum

coated, for baristas frothing hot milk
revestimiento, ideal para espume de leche
revêtement, idéal pour faire mousser le lait



	Ø cm	↑ cm	ltr.	€
10334	8,0	10,0	0,35	15,00
10335	9,0	11,5	0,60	18,20
10336	10,5	13,0	0,80	24,20



Milch- / Universalkanne

milk / water jug
jarra leche / agua
pichet à eau / lait

außen hochglanzpoliert, innen matt poliert, mit Maßskalierung innen

outside mirror polished, inside matt polished, with dimension scaling inside
exterior pulido brillante, interior pulido mate, con escala de dimensiones en el interior
extérieur poli brillant, intérieur poli mat, avec une échelle de dimension à l'intérieur



	Ø cm	↑ cm	ltr.	€
10328	8,0	10,0	0,35	7,80
10329	9,0	11,5	0,6	11,20
10330	10,5	13,0	0,8	15,00
10331	12,0	16,5	1,3	22,00
10332	13,5	18,0	2,0	26,40



Milch- / Universalkanne „VEGAN“

milk / water jug
jarra leche / agua
pichet à eau / lait

außen hochglanzpoliert, innen matt poliert, mit Gravur „VEGAN“

outside mirror polished, inside matt polished, with engraving „VEGAN“
exterior pulido brillante, interior pulido mate, con grabado „VEGAN“
extérieur poli brillant, intérieur poli mat, avec gravure „VEGAN“



	Ø cm	↑ cm	ltr.	€
10350	9,0	11,5	0,6	14,90
10351	10,5	13,0	0,8	18,90



10361

Milch- / Universalkanne

milk / water jug
jarra leche / agua
pichet à eau / lait



außen weiß pulverbeschichtet, innen matt poliert

outside white powder coated, inside matt polished
exterior recubrimiento de polvo blanco, interior pulido mate
extérieur revêtement en poudre blanc, intérieure poli mat

	Ø cm	↑ cm	ltr.	€
10360	8,0	10,0	0,35	15,60
10361	9,0	10,0	0,50	19,50
10362	9,5	11,5	0,75	21,40



mit Gravur am Boden
with engraving on the bottom



10323

Kaffeekanne

coffee pot
cafetera
pichet à café



hochglanzpoliert, mit Klappdeckel

mirror polished, with hinged cover
pulido brillante, tapa con bisagra
poli brillant, couvercle à charnière

	Ø cm	↑ cm	ltr.	€
10323	8,0	11,5	0,35	9,60
10322	9,0	14,0	0,6	13,00
10325	10,5	15,5	0,9	18,00
10326	12,0	18,5	1,5	24,40
10327	13,5	20,0	2,0	30,00



verstellbar durch Verschieben des Clips
adjustable by sliding the clip

Thermometer für Milchkännchen

thermometer for milk / water jug
termómetro para jarra leche / agua
thermomètre pour pichet à eau / lait



mit Clip, höhenverstellbar, Temperaturbereich 20°C bis 100°C, Graduierung 2°C

with clip, height adjustable, temperature range 20°C to 100°C, graduation 2°C
con clip, regulable en altura, rango de temperatura de 20°C a 100°C, graduación 2°C
avec clip, réglable en hauteur, plage de température 20°C à 100°C, graduation 2°C

	Ø cm	↑ cm	€
10355	4	13,5	5,80



GN 1/6 Abklopfbehälter

GN 1/6 tapping container
GN 1/6 contenedor knock-out
GN 1/6 bac knock-out

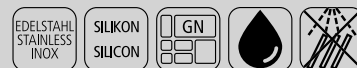

mit Abklopfstange aus Silikon, rutschfester Boden

with silicone tapping rod, non-slip bottom
con varilla de silicona, base antideslizante
avec tige en silicone, fond antidérapant

	cm	↑ cm	ltr.	€
81611	17,6 x 16,2	15	2,4	19,00



rutschfester Boden
non-slip bottom



00631

00634

Milch- und Zucker-Set „MILURO“

milk and sugar set
set de crema y azúcar
set lait et sucre

5-teilig: Tablett, Milchkanne, Zuckerdose mit Deckel, Löffel

5 pcs.: tray, milk jug, sugar bowl with lid, spoon

set de 5: bandeja, jarra de leche, azucarero con tapa, cuchara

set de 5: plateau, pichet à lait, sucrier avec couvercle, cuillère



	cm	↑ cm	Holz / Wood		€/ set
00631 NEW	19 x 10	10		bamboo	27,00
00634	19 x 10	10		acacia	27,00

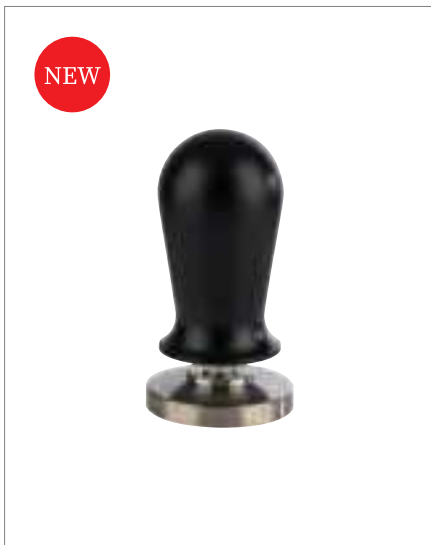
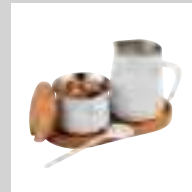

Tamper Ø 58 mm

Tamper aus Edelstahl mit Druckregulierung, schwarzer Griff

stainless steel tamper with pressure regulation, black handle

tamper de acero inoxidable con regulación de presión, mango negro

tamper en acier inox avec régulation de la pression, poignée noire



	ø mm	↑ cm	kg	€
10380	58	10	0,35	20,00

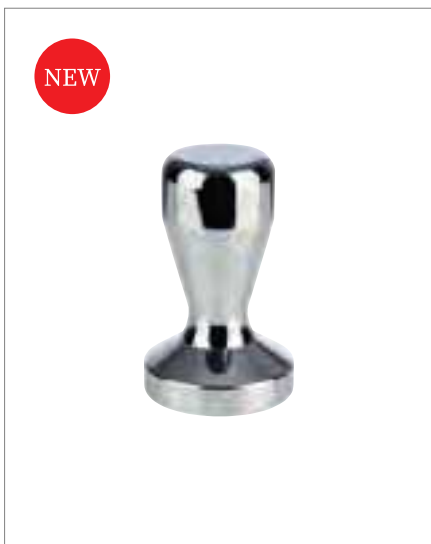

Tamper Ø 58 mm

Tamper aus Edelstahl

stainless steel tamper

tamper de acero inoxidable

tamper en acier inox



	ø mm	↑ cm	kg	€
10381	58	8,5	0,65	16,00



NEW **FLOW**



10305



10306



10307

Gießer „FLOW“

pouzer
vertedor
pichet

Vintage-Look, für Saucen, Dressings, etc.
vintage look, for sauces, dressings, etc.
look vintage, para salsas, aliños, etc.
look vintage, pour sauces, vinaigrettes, etc.



	ø cm	↑ cm	ltr.	Farbe / Colour	€
10305	6	6,5	0,15	 vintage-look	8,80
10306	6	6,5	0,15	 vintage-look gold (PVD)	8,80
10307	6	6,5	0,15	 vintage-look copper (PVD)	8,80



NEW ALLURE



Gießer, 4er Set „ALLURE“

pourer, set of 4
vertedor, set de 4
pichet, set de 4



hochglanzpoliert, für Kaffeesahne, Milch, Dessertsaucen, etc., tropffreies Ausgießen
highly polished, for coffee cream, milk, dessert sauces, etc., drip-free pouring
pulido brillante, para crema de café, leche, salsas de postre, etc., vertido sin goteo
poli brillant, pour crème à café, lait, sauces à dessert, etc., verser sans goutter

	ø cm	↑ cm	ltr.	Farbe / Colour	pcs.	€/ set
10300	4,5	4,0	0,03	stainless steel	4	11,80
10302	3,5	4,5	0,04	stainless steel	4	12,40



Gießer, 4er Set „ALLURE“

pourer, set of 4
vertedor, set de 4
pichet, set de 4



hochglanzpoliert, für Kaffeesahne, Milch, Dessertsaucen, etc., tropffreies Ausgießen
highly polished, for coffee cream, milk, dessert sauces, etc., drip-free pouring
pulido brillante, para crema de café, leche, salsas de postre, etc., vertido sin goteo
poli brillant, pour crème à café, lait, sauces à dessert, etc., verser sans goutter

	ø cm	↑ cm	ltr.	Farbe / Colour	pcs.	€/ set
10301	4,5	4,0	0,03	copper look (PVD)	4	13,00
10303	3,5	4,5	0,04	copper look (PVD)	4	13,60





Milchkännchen / Sahnegießer, 4er Set

milk/cream jugs, 4 pcs.
pack de 4 jarritas para leche o crema
pack de 4 crémiers

hochglanzpoliert, für Kaffeesahne, mit Griff, Inhalt à 25 ml
mirror polished, for coffee-cream, with handle, capacity à 25 ml
pulido brillante, para crema de café, con asa, capacidad 25 ml
poli brillant, avec anse, 25 ml



	Ø cm	↑ cm	ltr.	pcs.	€ / set
10321	3,5	3,5	0,025	4	15,00



10318

Gießer „HANDLE“

pouyer
vertedor
verseur



	Ø cm	↑ cm	ltr.	€
10318	4	4	0,05	2,40
10319	5	5	0,09	3,00
10320	6	6	0,15	3,60



Allzweckgießer

pouyer
bote vertedor universal
pot verseur universel

für Honig, Kaffeesahne, etc., Schraubdeckel
for honey, cream, etc., screw cap
para miel, crema, etc., tapa de rosca
pour le miel, le lait, la crème, etc., bouchon à vis



	Ø cm	↑ cm	ltr.	€
00765	8,5	13,5	0,3	9,00



40516

40517

Snackspender „NOTOUCH“

snack dispenser
dispensador de snacks
distributeur de snacks

Behälter aus Glas, Schraubdeckel aus Edelstahl, Öffnung oval 3,5 x 2,5 cm
glass container, stainless steel screw cap, opening oval 3,5 x 2,5 cm
recipiente de cristal, tapón de rosca de acero inoxidable, apertura ovalada 3,5 x 2,5 cm
récipient en verre, couvercle à visser en acier inox, ouverture ovale 3,5 x 2,5 cm



	Ø cm	↑ cm	ltr.	Farbe / Colour	€
40516	8,5	15,5	0,35	 gold-look	8,40
40517	8,5	15,5	0,35	 gunmetal-look	8,40

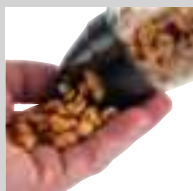



Zuckerdosierer

sugar dispenser
azucarero
sucrier



Schraubdeckel, mit Dosierrohr / screw cap, with dosing tube / tapa de rosca y tubo dosificador / bouchon à vis et tube doseur

	∅ cm	↑ cm	ltr.	€
40509	6	14,5	0,2	12,00



Zuckerdosierer

sugar dispenser
azucarero
sucrier



Schraubdeckel, mit Dosierrohr / screw cap, with dosing tube / tapa de rosca y tubo dosificador / bouchon à vis et tube doseur

	∅ cm	↑ cm	ltr.	€
00766	8,5	15	0,3	5,50



Zuckerdosierer

sugar dispenser
azucarero
sucrier



Schraubdeckel, mit Dosierrohr / screw cap, with dosing tube / tapa de rosca y tubo dosificador / bouchon à vis et tube doseur

	∅ cm	↑ cm	ltr.	€
40506	7,5	17	0,32	5,40



Zuckerdosierer

sugar dispenser
azucarero
sucrier



Schraubdeckel, mit Dosierrohr / screw cap, with dosing tube / tapa de rosca y tubo dosificador / bouchon à vis et tube doseur

	∅ cm	↑ cm	ltr.	€
40486	8	15	0,25	3,90



40490 150 ml

40494 250 ml

Zuckerdosierer

sugar dispenser
azucarero
sucrier



Schraubdeckel, mit Dosierrohr / screw cap, with dosing tube / tapa de rosca y tubo dosificador / bouchon à vis et tube doseur

	∅ cm	↑ cm	ltr.	€
40490	8,5	12	0,15	3,90
40494	8,0	15	0,25	3,90

Ersatzglasbehälter / spare glass-container / contenedor de repuesto / récipient verre de rechange

	fits to	€
40498	40490	1,80
40499	40494	1,80



Zuckerdosierer

sugar dispenser
azucarero
sucrier



Schraubdeckel mit Klappe aus Edelstahl, mit Dosierklappe

cover stainless steel, with dosing flap
tapa acero inoxidable, con tubo dosificador
couvercle inox, avec couvercle doseur

	Ø cm	↑ cm	ltr.	€
40487	7,5	13,5	0,32	4,80



Zuckerdosierer „OLD FASHIONED“

sugar dispenser
azucarero
sucrier



Schraubdeckel mit Klappe aus Edelstahl, mit Dosierklappe

cover stainless steel, with dosing flap
tapa acero inoxidable, con tubo dosificador
couvercle inox, avec couvercle doseur

	Ø cm	↑ cm	ltr.	€
40510	7,5	14	0,35	4,40



Zuckerkugel

sugar pot
azucarero
sucrier



hochglanzpoliert, mit Rolldeckel

mirror polished, rolltop cover
pulido brillante, tapa abatible
poli brillant, couvercle abattant

	Ø cm	↑ cm	€
00033	13,5	15	14,40



Teebrühsieb

snap mesh tea ball
infusor de té, pinza con malla
boule à thé avec pince



matt poliert, mit feinem Sieb, aufklappbar / matt polished, with fine mesh, hinged / pulido mate, con malla fina, con bisagra / poli mat, maille fine, avec charnière

	Ø cm	→ cm	€
74750	4,5	15,5	2,60



Serviertablett „KAFFEEHAUS“

tray
bandeja
plateau

matt poliert, Rand eingerollt

matt polished, rolled edge

acabado pulido efecto pulido mate, borde redondeado

effet poli mat, bord rond



	cm	↑ cm	€
30119	23 x 23	1,5	10,90
30118	21,5 x 13	1,5	7,90



Serviertablett „KAFFEEHAUS“

tray
bandeja
plateau

matt poliert, oval, Rand eingerollt

matt polished, oval, rolled edge

pulido mate, oval, borde redondeado

poli mat, ovale, bord rond

für Zucker und Sahne / for sugar and cream / para azúcar y crema / pour le sucre et la crème

	cm	↑ cm	€
30111	20,0 x 14,5	0,5	4,70

für eine Tasse / for one cup / para una taza / pour une tasse

	cm	↑ cm	€
30112	26,5 x 19,5	0,5	7,00

für zwei Tassen / for two cups / para dos tazas / pour deux tasses

	cm	↑ cm	€
30113	29,0 x 22,0	0,5	7,50



Serviertablett „KAFFEEHAUS“

tray
bandeja
plateau

hochglanzpoliert, oval, Rand eingerollt

mirror polished, oval, rolled edge

pulido brillante, ovalado, borde redondeado

poli brillant, ovale, bord rond

für Zucker und Sahne / for sugar and cream / para azúcar y crema / pour le sucre et la crème

	cm	↑ cm	€
30115	20,0 x 14,5	0,5	4,70

für eine Tasse / for one cup / para una taza / pour une tasse

	cm	↑ cm	€
30116	26,5 x 19,5	0,5	7,00

für zwei Tassen / for two cups / para dos tazas / pour deux tasses

	cm	↑ cm	€
30117	29,0 x 22,0	0,5	7,50





Serviertablett „KAFFEEHAUS“

tray
bandeja
plateau

hochglanzpoliert, stabiler Rand eingerollt
mirror polished, stable edge rolled in
pulido brillante, borde estable enrollado
poli brillant, bord stable enroulé



	cm	↑ cm	€
30148	Ø 27	1,5	6,00
30149	30 x 15,5	1,5	6,80

passende Hauben / cover / campana / cloche



	cm	↑ cm	suitable for	€
11055	Ø 23	12	30148	5,70
11056	26 x 12	10	30149	7,90



Präsentationsbeispiel
presentation example



Serviertablett „KAFFEEHAUS“

tray
bandeja
plateau

Innenfläche ziseliert, Rand eingerollt
chiselled inner surface, rolled edge
superficie interior cincelada, borde redondeado
surface intérieure ciselée bord rond

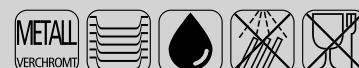

	cm	VE / unit	€ / pc.
30114	30 x 22	48	3,00



Serviertablett „KAFFEEHAUS“

tray
bandeja
plateau



	cm	↑ cm	€
84251	26,0 x 20,0	1,5	5,20
84253	28,5 x 21,5	1,5	5,80

TRAYS



Tablett

tray
bandeja
plateaux



Melamin, schwarz, mit Antirutsch-Füßchen, passendes Schneidebrett Nr. 762, 763

melamine, black, with non-slip feet, suitable cutting board art. 762, 763

melamina, negro, con pies antideslizantes, tabla de cortar adecuada art. 762, 763

mélamine, noir, avec pieds antidérapants, planche à découper appropriées art. 762, 763

	cm	↑ cm		€
85225	67 x 38	4		78,00



Tablett „VINTAGE“

tray
bandeja
plateau



Vintage-Look

	cm	↑ cm		€
30130	26,0 x 13,5	1,5	rectangular	8,00
30131	34,0 x 18,0	1,5	rectangular	13,20
30132	38,0 x 26,5	1,5	rectangular	21,00
30133	25,5 x 16,0	3,0	rectangular	16,00

passende Schälchen / fitting bowls / cuencos adecuados / bols apropiés



	Ø cm	↑ cm	litr.	€
40655	7,5	5,5	0,17	3,20
40656	7,5	10,0	0,35	4,00



Wachspapier „SNACKHOLDER“ / greaseproof paper squares
papel alimenticio para cucurucho / papier alimentaire pour cornet



	cm	pcs.	Motiv: Zeitung	€
40670	42 x 25	500		59,00



Präsentationsbeispiel
presentation example



Rechnungstablett
bill presenter
porta cuenta
porte-addition
mit Klemme für Rechnung
with clip for bill
con clip para la nota
avec clip pour la note



	cm	↑ cm	€
30108	20 x 12	1,5	2,40



Rechnungstablett
bill presenter
porta cuenta
porte-addition
mit Klemme für Rechnung
with clip for bill
con clip para la nota
avec clip pour la note



	cm	↑ cm	€
30110	17 x 11	1	6,30



Tischkrümelentferner
crumber
recogemigas
ramasse-miettes



geschliffene Edelstahlkante, matt poliert, einfache Handhabung
flat grinded stainless steel edge, matt polished, easy to handle
geschliffene Edelstahlkante, pulido mate, fácil de usar, mango hueco
geschliffene Edelstahlkante, poli mat, manche creux, simple à utiliser

	Ø cm	↑ cm	€
00581	19,5 x 4,5	1	8,00



71400

Rezeptionsglocke
ring bell
timbre
sonnette



	Ø cm	↑ cm	€
71400	8,5	6,0	6,20
71433	10,0	6,5	7,80

NON-SLIP TRAYS



Serviertablett „NOSLIDE“

tray
bandeja
plateau



rutschfeste Oberfläche / non-slip surface / superficie anti-deslizante / surface antidérapante

	cm	↑ cm	GN	€
00516	53 x 32,5	2,5	1/1	13,00
00517	53 x 36,5	2,0		16,00



Tablett „NOSLIDE“

tray
bandeja
plateau



rutschfeste Oberfläche / non-slip surface / superficie antideslizante / surface antidérapante

	Ø cm	↑ cm	€
00547	27,5	2	7,60
00548	35,5	2	9,60
00549	40,5	2	11,40



Tablett „BISTRO“

tray
bandeja
plateau



rutschfest, mit 2 Griffmulden und Stapelrand
non-slip, two open handles, stackable edge
antideslizante, con 2 asas y borde apilable
antidérapant, avec 2 poignées et bord d'empilage

	Ø cm	↑ cm	€
84045	35,5	4,5	26,00



Serviertablett „GRIPZONE“

tray non-slip
bandeja
plateau



rutschfeste Oberfläche / non-slip surface / superficie antideslizante / surface antidérapante

	cm	↑ cm	GN	€
00502	53,0 x 32,5	1,5	1/1	27,00
00508	46,0 x 36,0	2,0		24,80



Bierglasträger „GRIPZONE“

beer rack
bandeja para cerveza
porte verre à bière



rutschfeste Oberfläche / non-slip surface / superficie antideslizante / surface antidérapante

	Ø cm	↑ cm	€
00500	36	3,5	23,00
00506	28 x 20	1,5	10,40



Serviertablett „HAPPY HOUR“

tray
bandeja
plateau



rutschfeste Oberfläche / non-slip surface / superficie antideslizante / surface antidérapante

	Ø cm	↑ cm	€
00510	32	1,5	23,00
00511	38	1,5	28,00
00515	43	1,5	32,00



FAST FOOD



Tablett „FAST FOOD“
tray
bandeja
plateau



	cm	↑ cm	GN	Farbe / Colour	VE / unit	€/ pc.
00530	35 x 27,0	2			6	3,50
00535	41 x 30,5	2			6	4,70
00540	45 x 35,5	2			6	5,90
00552	53 x 32,5	2	1/1		6	7,20

	cm	↑ cm	GN	Farbe / Colour	VE / unit	€/ pc.
00531	35 x 27,0	2			6	3,50
00536	41 x 30,5	2			6	4,70
00541	45 x 35,5	2			6	5,90
00553	53 x 32,5	2	1/1		6	7,20

	cm	↑ cm	GN	Farbe / Colour	VE / unit	€/ pc.
00532	35 x 27,0	2			6	3,50
00537	41 x 30,5	2			6	4,70
00542	45 x 35,5	2			6	5,90
00554	53 x 32,5	2	1/1		6	7,20

	cm	↑ cm	GN	Farbe / Colour	VE / unit	€/ pc.
00533	35 x 27,0	2			6	3,50
00538	41 x 30,5	2			6	4,70
00543	45 x 35,5	2			6	5,90
00555	53 x 32,5	2	1/1		6	7,20

	cm	↑ cm	GN	Farbe / Colour	VE / unit	€/ pc.
00534	35 x 27,0	2			6	3,50

	cm	↑ cm	GN	Farbe / Colour	VE / unit	€/ pc.
00539	35 x 27,0	2			6	3,50



stapelbar
stackable

Präsentationsmöglichkeit
presentation example



Tretbeutelhalter „QUICKSTEP“

pedal bin
soporte a pedal
poubelle à pédale

geeignet für Müllbeutel bis 120 ltr., 110 x 70 cm

suitable for bags up to 120 ltr., 110 x 70 cm

apto para bolsas hasta 120 l., medidas sin bolsa 110 x 70 cm

apte pour sacs de 120 l., dim. sans sac 110 x 70 cm



	cm	↑ cm	€
00580	59 x 43	96	142,00



2 Lenkrollen
mit Feststellern
2 wheels with brakes



leichte Bedienung,
Trittmehanismus
easy handling, step on bin

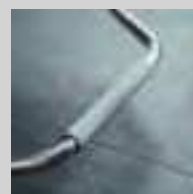

ASHTRAYS



00561



00562



00564

Windaschenbecher „VENTIS“

ashtray
cenicero
cendrier





Metall verchromt, Glas gefrostet, mit Bajonettverschluss

metal chrome plated, glass frosted, bayonet lock

metal cromado, opaco mate, cierre de bayoneta

métal chromé, mat, verrouillage par baïonnette

	Ø cm	↑ cm	Farbe / Colour	€
00561	9,5	8	 berry	9,00
00562	9,5	8	 green	9,00
00564	9,5	8	 black	9,00



mit Glutkiller
with ember killer



00585



00583



00584



00582

Windaschenbecher „NEBULA“

ashtray
cenicero
cendrier**Metall verchromt, Glas gefrostet, mit Bajonettverschluss**

metal chrome plated, glass frosted, bayonet lock

metal cromado, opaco mate, cierre de bayoneta

métal chromé, mat, verrouillage par baïonnette

	Ø cm	↑ cm	Farbe / Colour	€
00585	9,5	8	white	9,00
00583	9,5	8	yellow	9,00
00584	9,5	8	turquoise	9,00
00582	9,5	8	black	9,00

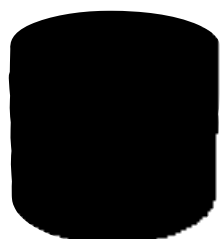
mit Glutkiller
with ember killer

Windaschenbecher „NEBULA“

ashtray
cenicero
cendrier**Metall matt-schwarz, Glas gefrostet, mit Bajonettverschluss**

metal matt black, glass frosted, with bayonet lock

metal negro mate, opaco mates, con cierre de bayoneta

métal noir mat, givré, verrouillage par baïonnette

	Ø cm	↑ cm	Farbe / Colour	€
00558	9,5	8	black matt	9,00

mit Glutkiller
with ember killer



Windaschenbecher „FORGE“

ashtray
cenicero
cendrier

mit Windschutzdeckel
with windcover
con tapa antiviento
avec couvercle anti-vent



	Ø cm	↑ cm	Farbe / Colour	€
00072 <small>NEW</small>	10	4,5	vintage-look	8,00
00090	10	4,5	stainless steel	8,00
00091	12	4,5	stainless steel	8,80

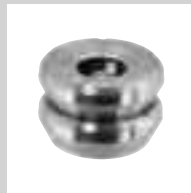

stapelbar
stackable



Windaschenbecher „ELEMENT“

ashtray
cenicero
cendrier

möbelschonende Unterseite
furniture-friendly bottom
base anti rayaduras
avec revêtement antirayures



	Ø cm	↑ cm	Farbe / Colour	€
00570	10,5	5	concrete	8,80
00559	10,5	5	black	8,80

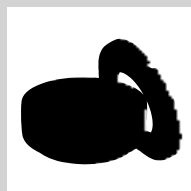



Windaschenbecher „TRAPDOOR“

ashtray
cenicero
cendrier



Deckel hochglanzpoliert, Behälter matt poliert, mit Windschutzdeckel
lid mirror polished, container matt polished, with windcover
con tapa antiviento pulida brillante y contenedor pulido efecto pulido mate
couverture anti-vent brillant, corps poli mat poli maté

	Ø cm	↑ cm	€
00052	12	5,5	9,80



Klappmechanismus
rotary button



Drehaschenbecher „PUSH“

ashtray
cenicero
cendrier



Deckel mit Drehmechanismus, mit Bajonettverschluss
with rotary button, bayonet lock
con botón giratorio, cierre de bayoneta
tourne par pression sur le bouton, verrouillage par baïonnette

	Ø cm	↑ cm	€
00058	9,5	11	11,00



Drehmechanismus
rotary button



Drehaschenbecher „PUSH“

ashtray
cenicero
cendrier giratoire



Deckel mit Drehmechanismus
with rotary button
con botón giratorio
tourne par pression sur le bouton

	Ø cm	↑ cm	Farbe / Colour	€
00054	13,0	10,5		9,40
00056	10,5	11		8,40



Drehmechanismus
rotary button



Windaschenbecher „GLEAM“

ashtray
cenicero
cendrier



	Ø cm	↑ cm	Farbe / Colour	€
83610	10	4,0	■	5,00
83612	12	4,5	■	5,40
83611	10	4,0	■	5,00
83613	12	4,5	■	5,40



Aschenbecher „EMBER“

ashtray
cenicero
cendrier



	Ø cm	↑ cm	Farbe / Colour	€
83616	9,5	4,5	■	2,80



Windaschenbecher „GLOW“

ashtray
cenicero
cendrier



	Ø cm	↑ cm	Farbe / Colour	€
83488	11,5	5	■	6,20
83489	11,5	5	■	6,00



Aschenbecher, 3er Set „KOLME“

ashtray, 3 pcs.
set de 3 cenicero
set de 3 cendriers



	Ø cm	↑ cm	Farbe / Colour	pcs.	€ / set
00576	8	3	■	3	3,20



Aschenbecher „ATLAS“

ashtray
cenicero
cendrier



matt poliert, hochwertige schwere Ausführung
matt polished, high quality, heavy gauge
pulido pulido mate, alta calidad, apilable
poli mat, empilable, belle qualité

	Ø cm	↑ cm	€
00048	8	3	8,40
00050	10	3	10,00



Windaschenbecher „SMOKY“

ashtray
cenicero
cendrier

mit abnehmbarem Deckel
with removable lid
con tapa extraíble
avec couvercle amovible



	Ø cm	↑ cm	Farbe / Colour		€
00586	8,5	11,5		schwarz / black	5,00
00578	8,5	11,5		verzinkt / galvanised	6,00



Standascher „DIABOLO“

standing ashtray
cenicero de pie
cendrier sur pied

für den Innen- und Außenbereich, inklusive 1,5 kg Sand, eine Ascheschale für die Sandbefüllung und ein Metallsieb

for in,- outdoor use, included a bag of sand and a metal sieve
uso en interior o exterior, incluye una bolsa de arena y embudo de metal
usage en intérieur ou extérieur, livré avec un sac de sable et entonnoir métal



	Ø cm	↑ cm	€
00574	40	60	76,00



vielseitig nutzbar
versatile

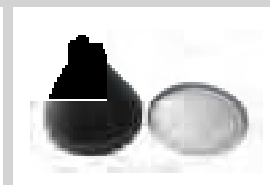

zerlegbar und stapelbar
dismountable and stackable





Kitchen & Servingttools

BANQUET.....	552
CLASSIC.....	554
DISPENSERS & EGG BOXES.....	581
DISPLAY TRAYS.....	582
EASYLIFT.....	558
MEASURING CUPS.....	584
PIZZA.....	588
PROFI.....	561
SPOONS.....	592
SQUEEZE BOTTLES.....	586
STRAINERS.....	578
STOP-TOOLS.....	556
TONGS.....	562
TOOLTIME.....	570
TWEEZERS.....	569
WHISKS.....	577

BANQUET



Die Vorlegeserie BANQUET ist die passende Ergänzung zum Servieren am Buffet. Durch die mattierte Oberfläche und das gebogene Griffende wird BANQUET praktischen und optischen Ansprüchen gerecht.

The series BANQUET is the perfect addition for serving at the buffet. Due to the matt surface and the curved handle, BANQUET meets practical and optical requirements.

La serie BANQUET es la adición perfecta para servir en el buffet. Debido a la superficie mate y al mango curvado, BANQUET cumple con requisitos prácticos y ópticos.

La série BANQUET est l'ajout parfait pour servir au buffet. Grâce à la surface mate et la poignée incurvée, BANQUET répond aux exigences pratiques et optiques.



Salat- / Servierlöffel „BANQUET“ salad spoon / serving spoon cuchara para ensalada / cuchara de servicio cuillère à salade / cuillère de service



	cm	Griff / handle cm	€
00588	6,0 x 5,0	17	5,60
00590	7,5 x 6,0	21	8,00



Salatgabel „BANQUET“ salad fork tenedor de servicio para ensalada fourchette de service pour la salade



	cm	Griff / handle cm	€
00589	6,0 x 5,0	17	5,60
00591	7,5 x 6,0	21	8,00



00589



00591



Schöpflöffel „BANQUET“ ladle cucharón louche



	cm	Griff / handle cm	€
00595	8,5 x 7,5	24	16,00



Chafing Dish Löffel „BANQUET“

serving spoon
cuchara para servir
cuillère de service



	cm	Griff / handle cm		€
00592	11 x 6,5	24		9,40
00593	11 x 6,5	24	geschlitzt / slotted	9,00



00593



Dressinglöffel „BANQUET“

dressing spoon
cuchara de aliño
cuillère à vinaigrette



	cm	Griff / handle cm		€
00594	6 x 4	30		11,50



Pfannenwender „BANQUET“

turner
espátula
spatule



	cm	Griff / handle cm		€
00587	10 x 7,5	21		9,00



Fleischgabel „BANQUET“

meat fork
tenedor de carne
fourchette à viande



	cm	Griff / handle cm		€
00596	8 x 2,5	13		4,90



Serviergabel „BANQUET“

fork
tenedor de servicio
fourchette de service



	cm	Griff / handle cm		€
00597	9 x 4	21		8,40



Tortenheber „BANQUET“

cake lifter
pala de tartas
pelle à gâteau
eine Kante gezahnt
one edge serrated
un borde serrado
denté sur un côté



	cm	Griff / handle cm		€
00598	14 x 6	13		7,00



Servierlöffel „CLASSIC“

serving spoon
cuchara de servicio
cuillère de service



Edelstahl Vintage-Look, ergonomisch profilierter Hohl-Griff

stainless steel vintage look, ergonomic designed handle
acero inoxidable aspecto vintage, asa ergonómica
acier inox look vintage, manche ergonomique

	cm	Griff / handle cm	Farbe / Colour		€
75920	8,0 x 6	21,5		vintage-look	9,30
75921	9,5 x 7	23,5		vintage-look	9,30



Servierlöffel „CLASSIC“

serving spoon
cuchara de servicio
cuillère de service



Edelstahl Vintage-Look, perforiert, Löcher Ø 4 mm, ergonomisch profilierter Hohl-Griff

stainless steel vintage look, perforated, holes Ø 4 mm, ergonomic designed handle
acero inoxidable aspecto vintage, perforado, agujeros Ø 4 mm, asa ergonómica
acier inox look vintage, perforé, trous Ø 4 mm, manche ergonomique

	cm	Griff / handle cm	Farbe / Colour		€
75922	9,5 x 7	23,5		vintage-look	9,30



Suppenkelle „CLASSIC“

soup ladle
cucharón de sopa
louche de service



Edelstahl Vintage-Look, ergonomisch profilierter Hohl-Griff

stainless steel vintage look, ergonomic designed handle
acero inoxidable aspecto vintage, asa ergonómica
acier inox look vintage, manche ergonomique

	Ø cm	Griff / handle cm	Farbe / Colour		€
75923	7	23		vintage-look	10,00
75924	9	24		vintage-look	11,00



Saucengießlöffel „CLASSIC“

sauce / gravy ladle
cucharón de salsa
cuillère à sauce



Edelstahl Vintage-Look, ergonomisch profilierter Hohl-Griff

stainless steel vintage look, ergonomic designed handle
acero inoxidable aspecto vintage, asa ergonómica
acier inox look vintage, manche ergonomique

	cm	Griff / handle cm	Farbe / Colour		€
75925	7 x 5,5	22		vintage-look	8,70



Tortenheber / Tortenmesser „CLASSIC“

cake server / cake knife
servidor de tartas / cuchillo para tartas
pelle à tarte / couteau à tarte



Edelstahl Vintage-Look, mit einer gezahnten Kante, ergonomisch profilierter Hohl-Griff

stainless steel vintage look, one edge serrated, ergonomic designed handle
acero inoxidable aspecto vintage, canto dentado, asa ergonómica
acier inox look vintage, bord microdenté, manche ergonomique

	cm	Griff / handle cm	Farbe / Colour		€
75926	8,0 x 5	10,5		vintage-look	8,60
75927	15,5 x 5	12,0		vintage-look	10,30



Servierlöffel „CLASSIC“

serving spoon
cuchara de servicio
cuillère de service



hochglanzpoliert, perforiert, Löcher Ø 4 mm, ergonomisch profilierter Hohl-Griff
mirror polished, perforated, holes Ø 4 mm, ergonomic designed handle
pulido brillante agujeros de Ø 4 mm, asa ergonómica
brillant, trous Ø 4 mm, manche ergonomique

	cm	Griff / handle cm	€
75903	9,5 x 7	23,5	9,30



Salatlöffel „CLASSIC“

salad spoon
cuchara para ensalada
cuillère à salade



hochglanzpoliert, ergonomisch profilierter Hohl-Griff
mirror polished, ergonomic designed handle
pulido brillante, asa ergonómica
poli brillant, manche ergonomique

	cm	Griff / handle cm	€
75902	8,0 x 6	21,5	9,30
75904	9,5 x 7	23,5	9,30



Suppenkelle „CLASSIC“

soup ladle
cucharón de sopa
louche de service



hochglanzpoliert, ergonomisch profilierter Hohl-Griff
mirror polished, ergonomic designed handle
pulido brillante, asa ergonómica
poli brillant, manche ergonomique

	Ø cm	Griff / handle cm	ml.	€
75907	7	23	60	10,00
75908	9	24	100	11,00



Saucengießlöffel „CLASSIC“

sauce / gravy ladle
cucharón de salsa
cuillère à sauce



hochglanzpoliert, ergonomisch profilierter Hohl-Griff, fugenlos
mirror polished, ergonomic designed handle, seamless
pulido brillante, asa ergonómica, sin soldadura
poli brillant, manche ergonomique, monobloc (sans soudure)

	cm	Griff / handle cm	ml.	€
75906	7 x 5,5	22	20	8,70



Tortenheber „CLASSIC“

cake lifter
pala de tartas
pelle à gâteau



hochglanzpoliert, mit einer gezahnten Kante, ergonomisch profilierter Hohl-Griff
mirror polished, one edge serrated, ergonomic designed handle
pulido brillante, canto dentado, mango ergonómico
poli brillant, bord microdenté, manche ergonomique

	cm	Griff / handle cm	€
75900	8,0 x 5	10,5	8,60
75912	15,5 x 5	12,0	10,30

STOP-TOOLS

Die STOP-Funktion verhindert, dass Gabel oder Löffel in das Gefäß rutschen.

The smart STOP-function prevent forks and spoon not to slip into the vessel.

La función STOP evita que los cubiertos se caigan dentro del recipiente.

La fonction STOP empêche les couverts de glisser dans le récipient.



Servierlöffel

serving spoon
cuchara para servir
cuillère à servir



Materialdicke 2,5 mm, ergonomischer, rutschfester Griff
material thickness: 2,5 mm, ergonomic antislip handle
grosor: 2,5 mm, mango ergonómico antideslizante
épaisseur : 2,5 mm, poignée ergonomique antidérapante

	cm	Griff / handle cm	€
00834	10 x 7,5	17	12,00



Servierlöffel geschlitzt

slotted spoon
cuchara para servir ranurada
cuillère à servir rainurée



Materialdicke 2,5 mm, ergonomischer, rutschfester Griff
material thickness: 2,5 mm, ergonomic antislip handle
grosor: 2,5 mm, mango ergonómico antideslizante
épaisseur : 2,5 mm, poignée ergonomique antidérapante

	cm	Griff / handle cm	€
00833	10 x 7,5	17	12,00



Schöpflöffel

ladle
cucharón
louche



Materialdicke 2,5 mm, ergonomischer, rutschfester Griff
material thickness: 2,5 mm, ergonomic antislip handle
grosor: 2,5 mm, mango ergonómico antideslizante
épaisseur : 2,5 mm, poignée ergonomique antidérapante

	Ø cm	Griff / handle cm	€
00832	9	17	13,00



Fleischgabel

meat fork
tenedor de carne
fourchette à viande



Materialdicke 2,5 mm, ergonomischer, rutschfester Griff
material thickness: 2,5 mm, ergonomic antislip handle
grosor: 2,5 mm, mango ergonómico antideslizante
épaisseur : 2,5 mm, poignée ergonomique antidérapante

	cm	Griff / handle cm	€
00831	10,5 x 4	17	12,00

**Servierlöffel geschlitzt**

slotted spoon

cuchara para servir ranurada

cuillère à servir rainurée

ergonomischer, rutschfester Griff

ergonomic antislip handle

mango ergonómico antideslizante

poignée ergonomique antidérapante



	cm	Griff / handle cm	€
00664	11 x 7	25	6,80

**Servierlöffel**

serving spoon

cuchara para servir

cuillère à servir

ergonomischer, rutschfester Griff

ergonomic antislip handle

mango ergonómico antideslizante

poignée ergonomique antidérapante



	cm	Griff / handle cm	€
00662	11 x 7	25	6,80

**Schöpföffel**

ladle

cucharón

louche

ergonomischer, rutschfester Griff

ergonomic antislip handle

mango ergonómico antideslizante

poignée ergonomique antidérapante



	cm	Griff / handle cm	ml.	€
00670	9 x 8	25	110	7,50

**Wender**

turner

espátula

spatule

ergonomischer, rutschfester Griff

ergonomic antislip handle

mango ergonómico antideslizante

poignée ergonomique antidérapante

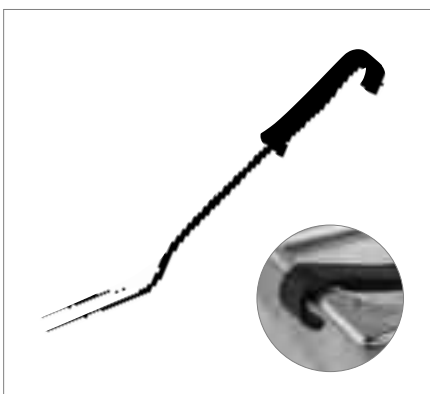

	cm	Griff / handle cm	€
00668	10 x 8	25	7,50

**Fleischgabel**

meat fork

tenedor de carne

fourchette à viande

ergonomischer, rutschfester Griff

ergonomic antislip handle

mango ergonómico antideslizante

poignée ergonomique antidérapante



	cm	Griff / handle cm	€
00666	10 x 3,5	25	6,80

EASYLIFT



Das Profimaterial Polyamid besteht aus Nylon und Fiberglas. Hitzebeständig bis 220°C, extra hochwertige Profi-Qualität, gut geeignet für antihaftbeschichtete Pfannen, ergonomischer Griff.

Polyamide is made of nylon and fiberglass. Heat-resistant up to 220°C, extra high quality, perfect for non-stick-coated pots and pans, ergonomic handle.

Poliamide de nylon y fibra de vidrio. Brevemente al calor hasta 220°, alta calidad profesional, ideal para sartenes antiadherentes, mango ergonómico.

Polyamide de nylon et fibre de verre, haute résistance brièvement à la chaleur jusque 220°C, qualité professionnelle, idéal pour les poêles antiadhérentes, manche ergonomique.

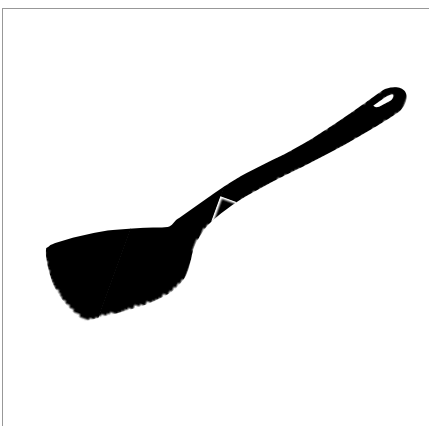

Bratenwender „EASYLIFT“

turner
espátula
spatule



	cm	Griff / handle cm	€
00603	11 x 9,5	23	6,70



Pfannenwender „EASYLIFT“

turner
espátula
spatule



	cm	Griff / handle cm	€
00600	11,5 x 9,5	23	6,60



Pfannenwender „EASYLIFT“

turner
espátula
spatule

	cm	Griff / handle cm	€
88642	13,5 x 9	18	4,80

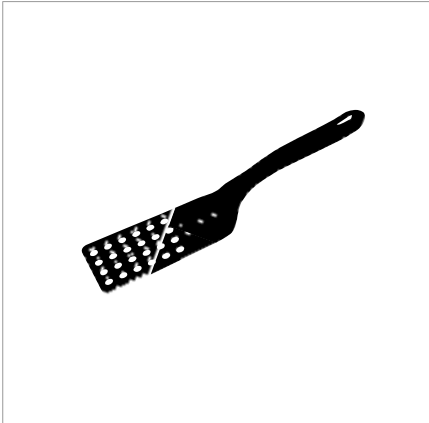

Pfannenwender „EASYLIFT“

turner
espátula
spatule

	cm	Griff / handle cm	€
88640	13 x 6,5	15	4,70

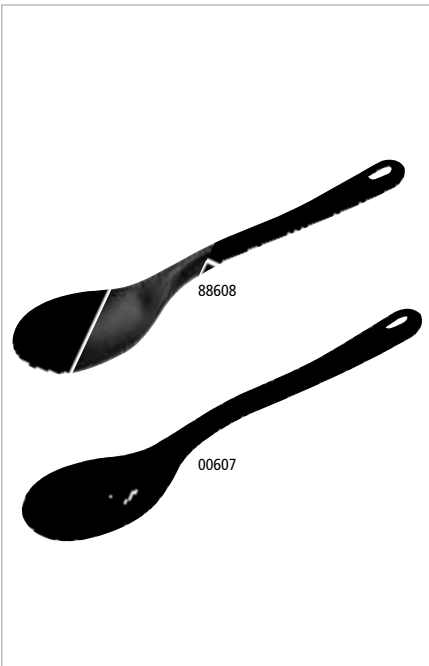

Servierlöffel „EASYLIFT“

serving spoon
cuchara de servicio
cuillère de service

	cm	Griff / handle cm		€
88608	12 x 7	23		6,60
00607	12 x 7	23	perforiert / perforated	6,20



Schaumlöffel „EASYLIFT“

skimmer
espumadera
écumoire

	Ø cm	Griff / handle cm	€
00602	11,5	23	6,70



Schöpflöffel „EASYLIFT“

ladle
cucharón
louche



	Ø cm	Griff / handle cm	ml.	€
00606	9	23	100	6,90



Spaghettizange „EASYLIFT“

spaghetti tongs
pinzas para espaguetis
pince à spaghettis



	cm	Griff / handle cm	€
88637	9 x 9	15	6,70



Toastzange „EASYLIFT“

sandwich tongs
pinzas para sandwich
pince à toasts



	cm	Griff / handle cm	€
00601	11 x 8	18	8,50

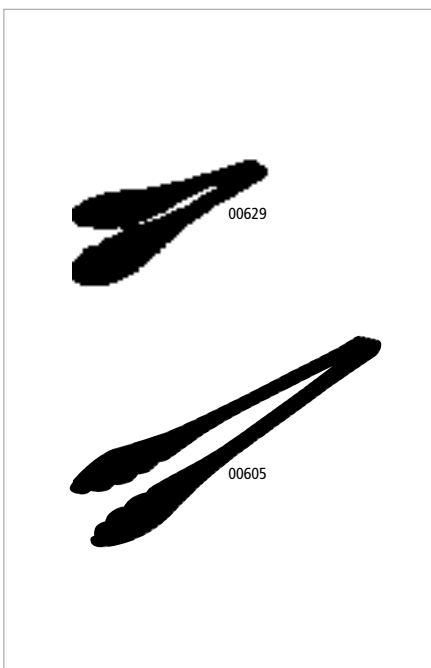

Salatzange „EASYLIFT“

salad tongs
pinzas para ensalada
pince à salade



	cm	Griff / handle cm	€
00629	8 x 5,5	17,5	6,50
00605	10 x 6,0	23,0	6,90

**Schöpflöffel „PROFI“**ladle
cacillo
louche

	Ø cm	Griff / handle cm	ml.	€
00711	6	28	50	12,20
00712	7	30	80	12,60
00713	8	32	125	13,60
00714	9	33	150	15,60
00715	10	35	250	16,30
00716	11	36	300	16,90

**Schaumlöffel „PROFI“**skimmer
espumadera
écumoire

	Ø cm	Griff / handle cm	€
00721	10	34	13,20
00722	12	37	14,10
00723	14	40	15,40

**Wender „PROFI“**turner
espátula
spatule

	cm	Griff / handle cm	€
00730	10 x 11,5	38	15,40

**Servierlöffel „PROFI“**serving spoon
cuchara de servicio
cuillère de service

	cm	Griff / handle cm	€
00672	11 x 7	29	9,20

**Spaghettilöffel „PROFI“**spaghetti spoon
cuchara de espaguetis
cuillère à spaghettis

	cm	Griff / handle cm	€
00673	10 x 7	29	9,90



Universalzange
all-purpose tongs
pinza universal
pince universelle



	cm	→ cm	Farbe / Colour	€
75825	7 x 5	22,5	vintage-look	10,90
75830	7 x 5	25,0	mirror polished	10,80
75831	7 x 5	25,0	gold-look	13,10
75832	7 x 5	25,0	copper-look	13,10

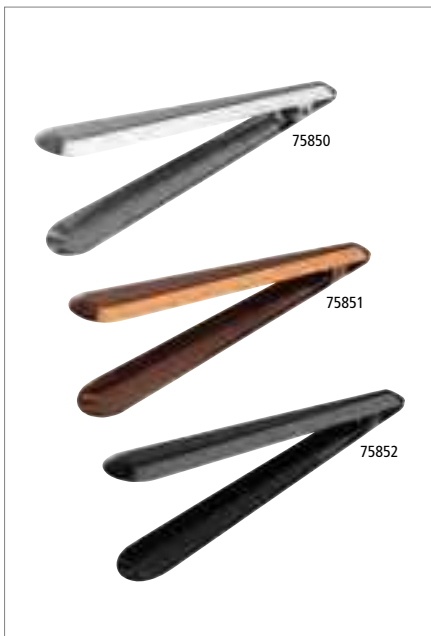

Universalzange
all-purpose tongs
pinza universal
pince universelle



hochglanzpoliert, mit Befestigungsclip
mirror polished, with fastening clip
pulido brillante, con clip de fijación
poli brillant, avec clip de fixation

	→ cm	Farbe / Colour	€
75850	19,5	mirror polished	4,20
75851	19,5	copper-look	4,60
75852	19,5	gunmetal-look	4,60

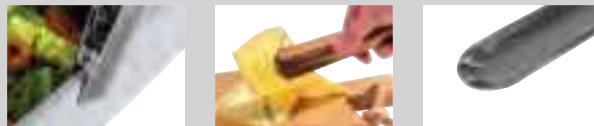

Zange kann an einer Schale befestigt werden
tongs can be attached to a bowl



Eiszange
ice tongs
pinzas para hielo
pinces de la glace



hochglanzpoliert, mit Befestigungsclip
mirror polished, with fastening clip
pulido brillante, con clip de fijación
poli brillant, avec clip de fixation

	→ cm	Farbe / Colour	€
75853	20	mirror polished	4,60
75854	20	copper-look	5,00
75855	20	gunmetal-look	5,00

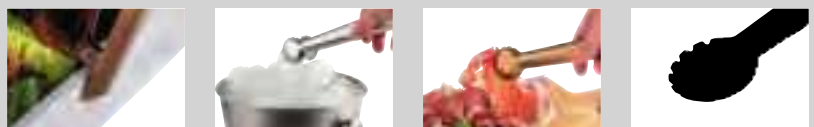

Zange kann an einer Schale befestigt werden
tongs can be attached to a bowl



Universalzange

all-purpose tongs
pinza universal
pince universelle

Edelstahl, Vintage-Look

stainless steel
acero inoxidable
acier inox



	cm	→ cm	Farbe / Colour	€
75824	7 x 5	22,5	 vintage-look	9,00



Vorspeisenzange „BANQUET“

appetizer tongs
pinza para aperitivos
pince à apéritif

Vorderteil poliert, Stiel mattiert

front part: high-shiny, handle: matt-finish
parte delantera pulida, asa mate
partie avant polie, poignée mate



	cm	→ cm	€
75822	4,5 x 3,5	20	8,90



Salatzange

salad tongs
pinza ensalada
pince à salade

hochglanzpoliert, beidseitig geschlitzt / mirror polished, slotted on both side
pulido brillante, agujereada en 2 lados / poli brillant, perforéedes 2 côtés



	cm	→ cm	€
75801	5 x 2	24	6,30



Spaghettizange

spaghetti tongs
pinza espaguetis
pince à spaghettis

hochglanzpoliert, fugenlos

mirror polished, seamless
pulido brillante, sin soldaduras
poli brillant, monobloc



	cm	→ cm	€
75810	6 x 3	19	4,80



Gebäckzange

pastry tongs
pinza para pasteles
pince à gâteaux

hochglanzpoliert, fugenlos, extra schwere Qualität

mirror polished, seamless, extra heavy gauge
pulido brillante, sin soldadura, alta calidad, resistente
poli brillant, monobloc, qualité extra, robuste



	cm	→ cm	€
75807	8,5 x 4	27,5	9,70



Salatzange „TIDLOS“

salad tongs
pinza ensalada
pince à salade

hochglanzpoliert, einseitig geschlitzt
mirror polished, slotted on one side
pulido brillante, agujereada en un lado
poli brillant, perforée d'un seul côté



	cm	→ cm	€
75842	5 x 2	22	6,20



Pastazange „TIDLOS“

pasta tongs
pinza espaguetis
pince à spaghettis

hochglanzpoliert, beidseitig geschlitzt
mirror polished, slotted on both side
pulido brillante, agujereada en 2 lados
poli brillant, perforéedes 2 côtés



	cm	→ cm	€
75843	8 x 5,5	22,5	6,20



Spargelzange „TIDLOS“

asparagus tongs
pinzas para espárragos
pince à asperges

hochglanzpoliert / mirror polished / pulido brillante / poli brillant



	cm	→ cm	€
75844	7 x 11	24,5	6,90



Gebäckzange „TIDLOS“

pastry tongs
pinza para pasteles
pince à gâteaux

hochglanzpoliert / mirror polished / pulido brillante / poli brillant



	cm	→ cm	€
75840	6,5 x 4,5	21	4,40



Servierzange „TIDLOS“

serving tongs
pinza universal
pince universelle

hochglanzpoliert / mirror polished / pulido brillante / poli brillant



	cm	→ cm	€
75841	7 x 4,5	21	5,20



Salatzange

salad serving tongs
pinza de ensalada
pinçe à servir la salade

hochglanzpoliert, einfache Handhabung

mirror polished, convenient handling
pulido brillante, manejo cómodo
poli brillant, manipulation aisée



	cm	→ cm	€
00685	7 x 4,5	25	16,40



Universalzange

all - purpose tongs
pinzas multiusos
pinçe multi-usages

hochglanzpoliert, einfache Handhabung

mirror polished, convenient handling
pulido brillante, manejo cómodo
poli brillant, manipulation aisée



	cm	→ cm	€
00688	7 x 4,5	25	16,40



Brot- und Gebäckzange

bread and pastry tongs
pinza para pan y bollería
pinçe à pain ou viennoiseries

hochglanzpoliert, einfache Handhabung

mirror polished, convenient handling
pulido brillante, manejo cómodo
poli brillant, manipulation aisée



	cm	→ cm	€
00686	7 x 4,5	25	16,40



Brot- und Gebäckzange

bread and pastry tongs
pinza para pan y bollería
pinçe à pain ou viennoiseries

hochglanzpoliert, einfache Handhabung

mirror polished, convenient handling
pulido brillante, manejo cómodo
poli brillant, manipulation aisée



	cm	→ cm	€
00687	7 x 4,5	25	16,40

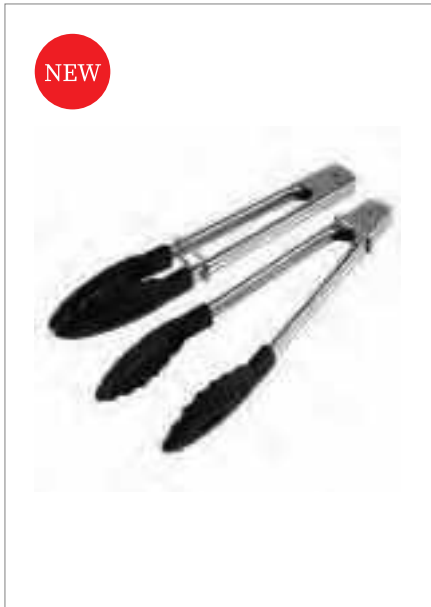

Mini-Universalzange, 2er Set

mini all-purpose tongs, 2 pcs.
mini pinzas multiusos, set de 2
mini pince multi-usages, set de 2



Edelstahl poliert, Greifer aus Polyamid, inklusive Haltering

polished stainless steel, polyamide gripper, including retaining ring
acero inoxidable pulido, pinzas de poliamida, anillo de retención incluido
acier inox poli, pincen en polyamide, anneau de retenue inclus

	→ cm	pcs.	€ / set
75870	18	2	9,00



Universalzange

all - purpose tongs
pinza universal
pince universelle



hochglanzpoliert, einseitig geschlitzt

mirror polished, slotted on one side
pulido brillante, agujereada en un lado
poli brillant, perforée d'un seul côté

	cm	→ cm	€
75800	5 x 2	24	5,00



Allzweckzange

multipurpose tongs
pinza multi-usos
pince universelle multi-usages



hochglänzend, mit Feder und Verschlusschieber, dekorative Greiferform

mirror polished, with spring and retaining clip, decorative gripper form
pulido brillante, con muelle y cierre deslizante, gancho con forma decorativa
poli brillant, avec mécanisme de verrouillage, forme de pince décorative

	cm	→ cm	€
88643	4 x 3	24	3,70
88644	4 x 3	30	4,50
88645	4 x 3	40	4,90



Aufschnitt- / Allzweckzange

sausage tongs
pinza salchichas
pince à saucisses



hochglanzpoliert, fugenlos / mirror polished, seamless / pulido brillante, sin soldadura / poli brillant, monobloc

	cm	→ cm	€
75806	3 x 2,5	16	4,00

**Gebäckzange**

pastry tongs
pinza para pasteles
pince à gâteaux

hochglanzpoliert, perforiert

mirror polished, perforated
pulido brillante, perforado
poli brillant, perforée



	cm	→ cm	€
75804	6,5 x 3	19,5	8,40

**Gebäck- / Tortenzange**

pastry tongs
pinza para pasteles
pince à gâteaux

hochglanzpoliert, fugenlos

mirror polished, seamless
pulido brillante, sin soldadura
poli brillant, monobloc



	cm	→ cm	€
75803	7 x 3,5	17,5	5,40

**Eisportionierer**

ice cream scoop
cuchara para helado
cuillère à glace

hochglanzpoliert, mit Edelstahlfeder (physikalisch bedingt nicht korrosionsbeständig)

mirror polished, spring steel, spring is not stainless
pulido brillante, muelle de acero especial, no resistente al óxido
poli brillant, ressort acier spécial, non résistant à l'oxydation

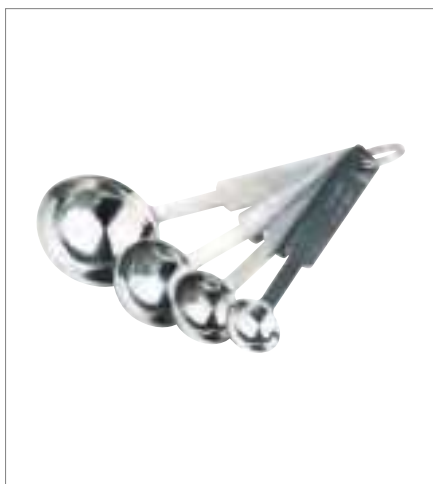

	Ø cm	→ cm	ltr.	€
71006	6,5	23,5	1/12	11,60
71005	6,0	22,5	1/16	11,60
71004	5,5	22,0	1/20	11,60
71003	5,0	22,0	1/24	11,60
71002	5,0	21,5	1/30	11,60
71001	4,5	21,0	1/36	11,60

**Messlöffelsatz**

set measuring spoon
juego de cucharas medidoras
jeu de cuillère à mesure

Löffel hochglanzpoliert, Stiele matt poliert, Skalierung:**1 Esslöffel, 1 Teelöffel, 1/2 Teelöffel, 1/4 Teelöffel**

bowl mirror polished, handles matt polished, measures:
table spoon, tea spoon, 1/2 tea spoon, 1/4 tea spoon

bol medidor brillante, mango mate medidas:

1 cuchara de sopa, 1 cuchara de té, 1/2 cuchara de té, 1/4 cuchara de té
corps brillant, manche mat, mesures:

1 cuillerée à soupe, 1 cuillerée à thé, 1/2 cuillère à thé, 1/4 de cuillère à thé



	cm	€
75600	14 x 4,5	6,70



Universalzange „SPECTRA“

all-purpose tongs
pinzas multiusos
pince multi-usages



Griff matt beschichtet / matt coated handle / mango recubierto de mate / poignée revêtue de mat

	→ cm	Farbe / Colour		€
75860	24		gelb	4,60
75861	24		rot	4,60
75862	24		grün	4,60
75863	24		blau	4,60
75864	24		schwarz	4,60

HACCP Farbkennzeichnung Konzept
HACCP color coding concept



matte Antirutschummatellung
matt anti-slip coating



Universalzange „SPECTRA“

all-purpose tongs
pinzas multiusos
pince multi-usages



Griff matt beschichtet / matt coated handle / mango recubierto de mate / poignée revêtue de mat

	→ cm	Farbe / Colour		€
75865	30		gelb	5,40
75866	30		rot	5,40
75867	30		grün	5,40
75868	30		blau	5,40
75869	30		schwarz	5,40

HACCP Farbkennzeichnung Konzept
HACCP color coding concept



matte Antirutschummatellung
matt anti-slip coating



Pinzettenzange

fine tongs / tweezers
pinza de emplatar
pince à dresser

hochglanzpoliert, geriffelte Grifffläche, schwere Qualität

mirror polished, ribbed handle, heavy gauge
pulido brillante, mango cómodo ranurado, alta calidad
poli brillant, manche rainuré antiglisse, qualité extra



	→ cm	€
75820	16	6,60



Pinzettenzange

fine tongs / tweezers
pinza de emplatar
pince à dresser

hochglanzpoliert, geriffelte Grifffläche, schwere Qualität

mirror polished, ribbed handle, heavy gauge
pulido brillante, mango cómodo ranurado, alta calidad
poli brillant, manche rainuré antiglisse, qualité extra



	→ cm	€
75821	30	9,90



Pinzettenzange

fine tongs / tweezers
pinza de emplatar
pince à dresser

hochglanzpoliert, geriffelte Grifffläche, schwere Qualität

mirror polished, ribbed handle, heavy gauge
pulido brillante, mango cómodo ranurado, alta calidad
poli brillant, manche rainuré antiglisse, qualité extra



	→ cm	€
75809	30	8,40



Pinzettenzange

fine tongs / tweezers
pinza de emplatar
pince à dresser

hochglanzpoliert, geriffelte Grifffläche, abgerundete Spitzen vorne, schwere Qualität

mirror polished, ribbed handle, rounded on the tops, heavy gauge
pulido brillante, mango cómodo ranurado, alta calidad, puntas redondeadas
poli brillant, manche rainuré antiglisse, qualité extra, pointes arrondies



	→ cm	€
75808	14,5	5,50

TOOLTIME



Kugelausstecher - doppelt „TOOLTIME“

melon baller - double
vaciador doble de bola
moule à boule double



zum Formen von Kugeln aus Obst, Gemüse oder Butter, Edelstahl mit geschärften Rändern
to form balls out of fruits, vegetables, butter, etc., stainless steel with sharpened edge
para hacer bolas con frutas, verduras, mantequilla, etc. acero inoxidable con borde afilado
pour faire des boules de fruits, légumes, beurre, etc. inox, bord affûté

	Ø cm	→ cm	€
88810	2,2 + 2,5	16,5	7,50
88811	2,2 + 3,0	17,0	7,60



Fadenschneider / Zester „TOOLTIME“

decorator / zester
cuchillo de decoración cincelador
couteau zesteur



zum Abziehen von feinsten Schalenstreifen, ideal zum Dekorieren von Torten und Desserts
to peel off very fine stripes of paring, these stripes are ideal to decorate desserts, cakes, etc.
para pelar tiras muy finas, ideal para decorar postres, tartas, etc.
pour couper en lanières fines, idéal pour la décoration de gâteaux et desserts, etc.

	Ø cm	→ cm	€
88823	0,2 + 0,5	14,5	4,20



Ziseliermesser „TOOLTIME“

canele / decorating knife
cuchillo de decoración cincelador acanalado
couteau zesteur cannelé



zum Einritzen von Linien und Mustern in hartschaliges Obst und Gemüse, Edelstahl mit geschärften Rändern

to score lines or design in hard fruits and vegetables, stainless steel with sharpened edge
para dibujar líneas en frutas o verduras de piel dura, acero inoxidable con borde afilado
pour découper des lignes et motifs sur fruits et légumes à peau dure ou pour peler les zestes des citrons ou oranges, inox, bord affûté

	→ cm	€
88826	15	4,20



Sparschäler „TOOLTIME“

peeler
pelador
peleur



für Links- und Rechtshänder geeignet, mit zwei starren Klingen aus extra geschärftem + gehärtetem Edelstahl

useable left- and right handed, with 2 inflexible blades made out off sharpened, extra hardened stainless steel

para diestros y zurdos, con 2 cuchillas rígidas inox afiladas y muy resistentes
pour gauchers ou droitiers, 2 lames rigides affûtés en inox extra-résistant

	→ cm	€
88827	17	2,80



Pendelschäler „TOOLTIME“

swivel peeler
pelador reversible
éplucheur droitier/gaucher



für Links- und Rechtshänder, ideal für das Schälen von Tomaten, mit 2 beweglichen Klingen

suitable for right and left handed, ideal to peel tomatoes, with 2 flexibles blades

apto para diestros y zurdos, ideal para pelar tomates, con 2 hojas flexibles

pour gauchers ou droitiers, idéal pour peler les tomates, 2 lames flexibles

	→ cm	€
88850	16,5	4,60



Apfelentkerner „TOOLTIME“

apple corer
descorazonador de manzana
vide-pomme



durch leichtes Drehen kann das Kerngehäuse von Äpfeln, Birnen und anderen Früchten sorgsam herausgeholt werden, Edelstahl mit geschärften Rändern

with a light turn cores of apples, pears and other fruits can be cut off easily, stainless steel with sharpened edge

para descorazonar muy fácilmente manzanas, peras y otras frutas

pour évider facilement les pommes, poires ou autres fruits

	∅ cm	→ cm	€
88836	2,2	21	3,30



Cocktailmesser „TOOLTIME“

bar knife
cuchillo para cóctel
couteau cocktail

mit 2 Zinken zum Aufspießen von Zitrusseiben
with 2 prongs to pick up slices of lemon
con 2 dientes para pinchar las rodajas de limón, etc.
avec 2 dents pour les rondelles de citron et autres décorations



	→ cm	€
88846	21	4,80



Dekoriermesser „TOOLTIME“

decorating knife „cannelé“
cuchillo acanalador
couteau cannelé

gezähnte Klinge aus geschärftem Edelstahl
serrated sharpened blade, stainless steel
hoja de sierra afilada, acero inoxidable
lame inox microdentée



	→ cm	€
88843	19	5,90



Pendelschäler „TOOLTIME“

swivel peeler
pelador lama pivotante
peleur lame pivotante

zum schnellen und sparsamen Schälen von Obst und Gemüse, mit beweglicher Klinge
to peel fruits and vegetables with flexible blade
para pelar frutas y verduras con hoja flexible
pour couper des fruits et légumes avec lame flexible



	→ cm	€
88834	17	5,20



Käsehobel „TOOLTIME“

cheese slicer
rebanador de queso
couteau tranche-fromage

zum Schneiden von dünnen Käsescheiben
to cut thin slices of cheese
para cortar lonchas finas de queso
pour couper de fines tranches de fromage



	→ cm	€
88853	21,5	5,90

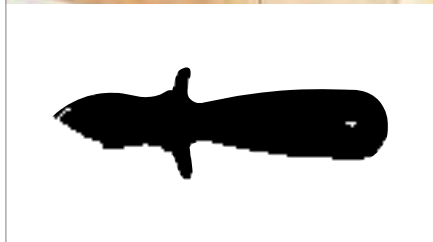

Austernöffner „TOOLTIME“

oyster knife
 abre ostras
 couteau à huîtres



zum einfachen Aufbrechen von Austern, mit Fingerschutz, Edelstahl mit geschärften Rändern
 to open oysters easily, with guard, stainless steel with sharpened edge
 para abrir ostras fácilmente con protección para los dedos, acero inoxidable con punta afilada
 pour ouvrir facilement les huîtres avec protection pour les doigts, inox, pointe affûtée

	→ cm	€
88839	14,5	7,10



Austernmesser „TOOLTIME“

oyster knife
 abre ostras
 couteau à huîtres



Edelstahlklinge zum Einstecken in die Schale, mit Fingerschutz
 stainless steel blade for prick the shell, with finger guard
 para abrir ostras fácilmente con protección para los dedos
 pour ouvrir facilement les huîtres avec protection pour les doigts

	→ cm	€
88840	15	4,10



Pizzaschneider „TOOLTIME“

pizza cutter
 cortador de pizza
 coupe-pizza



ergonomischer Griff
 ergonomic handle
 mango ergonómico
 manche ergonomique

	Ø cm	→ cm	€
88949	10	20	6,70



Pizaroller „TOOLTIME“

pizza cutter
 cortador de pizza
 roulette à pizza



	Ø cm	→ cm	€
88829	6	18,5	4,80



Winkelpalette „TOOLTIME“

turner
espátula
spatule

flexible Edelstahlklinge
flexible blade stainless steel
hoja flexible acero inoxidable
lame inox flexible



	cm	→ cm	€
88935	34,0 x 5	47,5	9,90
88937	24,0 x 4	36,0	7,10
88938	18,5 x 3	32,0	6,40



Winkelpalette „TOOLTIME“

spatula
espátula
spatule

flexible Edelstahlklinge
flexible blade stainless steel
hoja flexible acero inoxidable
lame inox flexible



	cm	→ cm	€
88928	17 x 5	30	6,80



Gebäckpalette „TOOLTIME“

pastry spatuala
paleta pastelera
spatule pâtissière

flexible Edelstahlklinge
flexible blade stainless steel
hoja flexible acero inoxidable
lame inox flexible



	cm	→ cm	€
88932	17 x 7,5	29,5	7,60



Wender „TOOLTIME“

turner
espátula
spatule

flexible Edelstahlklinge
flexible blade stainless steel
hoja flexible acero inoxidable
lame inox flexible



	cm	→ cm	€
88933	15 x 6	27,5	6,10



Wender „TOOLTIME“

turner
espátula
spatule

perforiert, flexible Edelstahlklinge
perforated, flexible blade stainless steel
hoja flexible inox agujereada
lame ajourée inox flexible



	cm	→ cm	€
88940	24,5 x 7,5	37,5	9,40



Wender „TOOLTIME“

turner
espátula
spatule

flexible Edelstahlklinge
flexible blade stainless steel
hoja flexible acero inoxidable
lame inox flexible



	cm	→ cm	€
88939	24 x 7,5	37,5	9,10



Wender „TOOLTIME“

turner
espátula para plancha
spatule

flexible Edelstahlklinge
flexible blade stainless steel
hoja flexible acero inoxidable
lame inox flexible



	cm	→ cm	€
88941	20 x 7,5	33	8,00
88942	15 x 9,0	28	7,90



Spachtel / Fettabstecher „TOOLTIME“

scraper
espátula plancha
spatule coudée spéciale grill

starre Edelstahlklinge
rigid blade stainless steel
hoja rígida de acero inoxidable
lame rigide inox



	cm	→ cm	€
88946	17 x 10,0	30	9,10
88947	15 x 7,5	28	7,60



Spachtel / Schaber „TOOLTIME“

scraper
 espátula plancha
 spatule coudée spéciale grill

starre Edelstahlklinge
 rigid blade stainless steel
 hoja rígida acero inoxidable
 lame inox rigide



	cm	→ cm	€
88929	11 x 10	25	7,60



Aufstrichmesser „TOOLTIME“

sandwich knife
 cuchillo para untar
 couteau à tartiner

flexible Edelstahlklinge
 flexible blade stainless steel
 hoja flexible acero inoxidable
 lame inox flexible



	cm	→ cm	€
88948	8,5 x 3	18,5	2,80



Teigschaber / Abstecher „TOOLTIME“

dough scraper
 corta pasta
 coupe-pâte

starre Edelstahlklinge
 rigid blade stainless steel
 hoja rígida de acero inoxidable
 lame rigide inox



	cm	€
88930	15,5 x 8	5,20

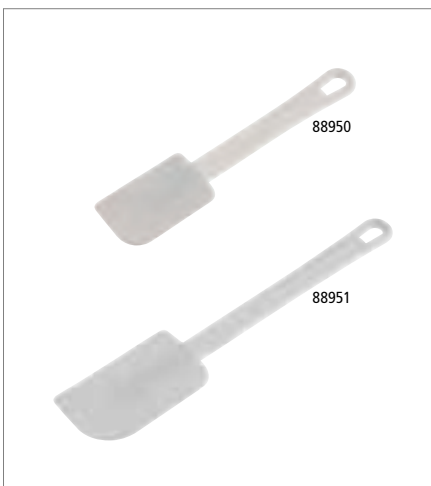

Teigspatel / Stielschaber
 dough spatula / handle scraper
 espátula masa / rascador
 spatule à pâte / raclette

Aufhängeloch
 with hanging hole
 con agujero para colgar
 avec trou de suspension



	→ cm	€
88950	25,5	10,00
88951	35,5	12,00

**Hummerbrecher**

lobster cracker
pinza bogavante
pince à homard



	cm	€
74201	14 x 5,5	8,80

**Eierschneider**

egg cutter
corta huevos
coupe-oeufs

zum Längs- und Querteilen von hart gekochten Eiern

to cut hard-boiled eggs
corta a rodajas un huevo duro
en rondelles

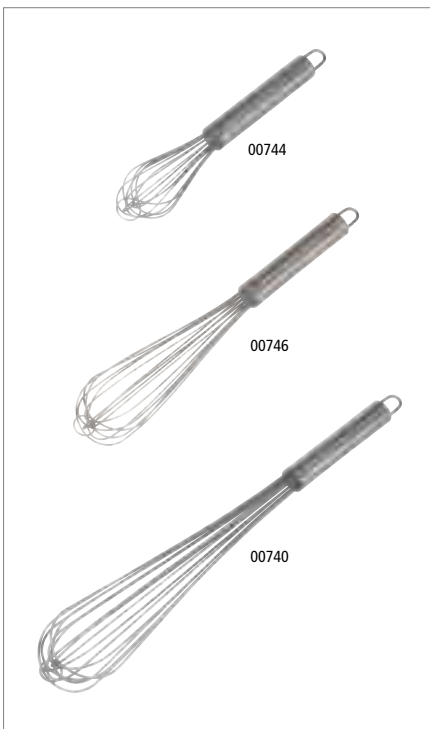

	cm	↑ cm	€
88099	14,5 x 8	2,5	2,50

**Schneebesen**

whisk
batidor
fouet



	Drähte / wires	→ cm	€
00744	8	28	6,60
00745	8	33	6,80
00746	8	38	8,40
00747	8	43	9,50
00740	8	48	10,00

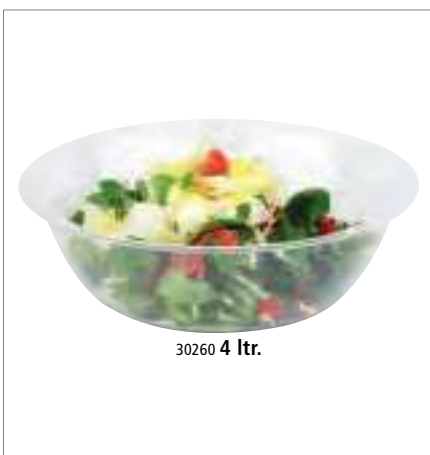

30260 4 ltr.

Schüssel

bowl
ensaladera
saladier
glasklar
crystal clear
cristalina
transparent



	Ø cm	↑ cm	ltr.	€
30260	32,5	10	4	5,10
30263	40,0	12	8	10,40



Saucen- und Fondantrichter

sauce and confectionary funnel
embudo para salsa y confitería
entonnoir à sauce et confiserie



ergonomischer Griff, Maßskalierung innen, mit 3 Düsen Ø 4, 5, 6 mm, inklusive Ständer und Auffangschale

ergonomic handle, scaling inside, with 3 different nozzles Ø 4, 5, 6 mm, including wire rack a. dripping dash

mango ergonómico, escalado interior, con 3 boquillas, Ø 4, 5, 6 mm, incl. pie de alambre y bandeja recoge gotas

manche ergonomique, mise à l'échelle à l'intérieur, 3 douilles de Ø 4, 5 et 6 mm, inclut pied avec ramasse-gouttes

	Ø cm	↑ cm	ltr.	€
77338	21	31,5	1,5	98,00



Anwendungsbeispiel
application example



Maßskalierung innen
scaling inside



Gazespitzsieb

conical strainer with wire gauze
colador chino de malla
chinois renforcé avec maille fine



hochglanzpoliert, mit rundem Hohlgriff, ca. 9 Löcher pro 1 cm²

mirror polished, 9 holes per 1 cm²

pulido brillante, mango hueco, 9 agujeros por 1 cm²

poli brillant, manche creux, 9 trous pour 1 cm²

	Ø cm	↑ cm	Griff / handle cm	€
88717	25	19	24	44,00



Spitzsieb

conical strainer
colador cónico
chinois



mit Lochung Ø 1,5 mm, auch in der Kegelspitze, mit Flachstiel, mit Stützstiel zum Einhängen in den Topfrand

with Ø 1,5 mm holes (including the tip), with flat handle, with supporting hook

con agujeros finos de Ø 1,5 mm (incluida la punta), con mango plano y gancho

perforations fines 1,5 y compris à la pointe, manche plat et crochet

	Ø cm	↑ cm	Griff / handle cm	€
00771	23	18	16,5	26,00



Barsieb

bar strainer
colador de cóctel
tamis cocktail



	Ø cm	↑ cm	Griff / handle cm	€
93318	8,5	5	11,5	4,50





Wasserbadschüssel
 bain marie bailing bowl
 cazo para baño maría
 récipient bain-marie



hochglanzpoliert, mit Drahtgriff Ø 5 mm
 mirror polished, with wire handle Ø 5 mm
 pulido brillante, mango varilla Ø 5 mm
 poli brillante, manche fil épaisseur Ø 5 mm

	Ø cm	↑ cm	Griff / handle cm	ltr.	€
74731	18	9	15	1,5	14,70



Anwendungsbeispiel
 Application Example

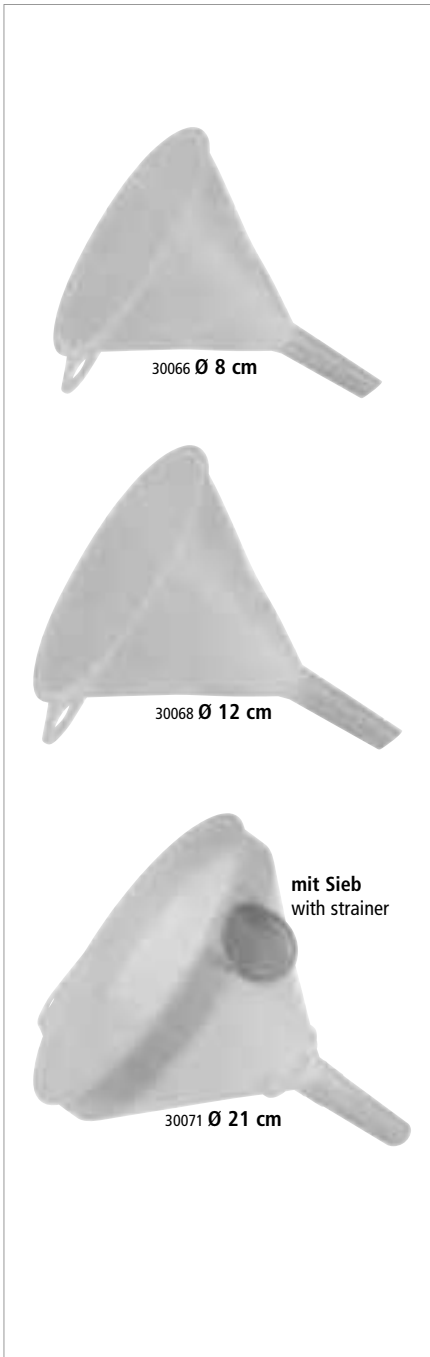

Trichter „PROFI“

funnel
 embudo
 entonnoir
 mit Öse
 with eyelet
 con ojal
 avec œillet



	Ø cm	Ø mm Durchlass		€
30066	8	11		1,30
30068	12	12		2,20
30071	21	20	mit Sieb / incl. strainer	7,60



erleichtert das Einfüllen
 facilitates filling

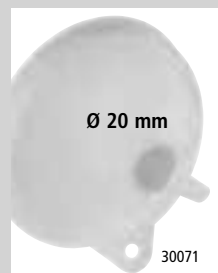

mit einsetzbarem Sieb
 incl. insertable strainer



STRAINERS



Seiher
strainer
colador
passoire



2 Griffe: je 2 cm / 2 handles: each 2 cm / 2 asa: 2 cm cada una / 2 poignées: 2 cm chacune

	Ø cm	↑ cm	Farbe / Colour	€
00786	27,5	12		8,00
00787	27,5	12		8,00



Seiher
strainer
colador
passoire



mit 2 Muschelgriffen / with 2 shell shaped grips / con dos asas / à 2 anses moulées

	Ø cm	↑ cm	€
00780	36	19	12,50



Pommes-Frites-Seiher
chip colander
escurridor de fritos
égouttoir à friture



herausnehmbarer Locheinsatz, mit Handgriff

removable drainer, with handle
fondo de colador desmontable, con asa
fond démontable, avec poignée

	Ø cm	↑ cm	€
00785	39	19	34,00



Salzstreuer
salt shaker
salero
salière



Pommes-Frites Streuer mit Schraubkappe

for french fries, cover to screw
para patatas fritas, tapa de rosca
pour les frites, couvercle à visser

	Ø cm	↑ cm	€
00772	8	17	15,00



Salzstreuer
salt shaker
salero
salière



Pommes-Frites Streuer mit Schraubkappe

for french fries, cover to screw
para patatas fritas, tapa de rosca
pour les frites, couvercle à visser

	Ø cm	↑ cm	€
00779	8	17	9,90



1,7 ltr.

Dosierspender

dosing dispenser
dosificador
distributeur de dosage



Behälter aus Glas, ideal zum Dosieren von Marmelade, Joghurt und Saucen (ohne Stücke / Fruchtfleisch)
glass container, ideal for dosing jam, yoghurt and sauces (without pieces / pulp)
recipiente de cristal, ideal para dosificar mermelada, yogur y salsas (sin trozos / pulpa)
récipient en verre, idéal pour doser la confiture, le yaourt et sauces (sans morceaux / pulpe)

	Ø cm	↑ cm	ltr.	€
93290	13	31	1,7	24,00

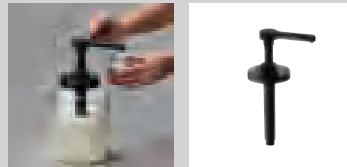

Hubvolumen 15 ml
stroke volume 15 ml



93281

93280
2,6 ltr.

Dosierspender

dispenser
dispensador de salsa
doseur à sauce

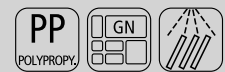

	cm	↑ cm	ltr.	GN	€
93280	17,6 x 16,2	27	2,6	1/6	26,00

Dosierpumpe, Hubvolumen 30 ml
dosing pump / riser tube, swept volume 30 ml
bomba de salsa, sola, cada dosis 30 ml
pompe à sauce, 30 ml par dose



	cm	↑ cm	ltr.	€
93281	12,5 x 4,5	26	0,30	fits to 93280 18,00



Dosierpumpe

dosing pump / riser tube
bomba de salsa, sola
pompe à sauce

Hubvolumen 30 ml / swept volume 30 ml / cada dosis 30 ml / 30 ml par dose



	Ø cm	↑ cm	€
88271	4,5	40	11,10

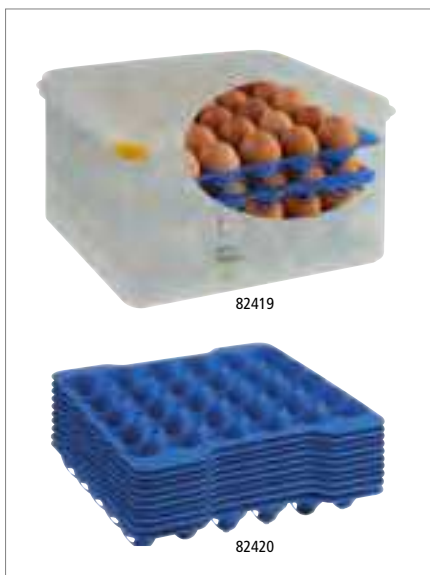

82419

82420

Eier-Box

eggs box
caja para huevos
boîte à oeufs



mit luftdichtem Deckel, für 4 Lagen à 30 Eier, Lieferung inkl. 4 Lagen, Größe Lage: 28 x 28 cm
with airtight cover, capacity: 4 trays of 30 eggs, delivery with 4 trays, size of tray: 28 x 28 cm
capacidad para 4 bandejas de 30 huevos, tapa hermética, se entrega con 4 bandejas, formato bandejas 28 x 28 cm, apto para lavavajillas
pour 4 plateaux de 30 oeufs chacun, apte pour 4 plateaux plats, couvercle hermétique, livré avec 4 plateaux, dimension plateau 28x28 cm, lavable en lave-vaisselle

	cm	↑ cm	GN	€
82419	35,4 x 32,5	20	2/3	39,90

4 Lagen / 4 trays / 4 bandejas / 4 plateaux

	€
82420	12,50

DISPLAY TRAYS



Ausstellblech / Thekenblech

display tray
bandeja pastelera
plaque pâtissière

hitzebeständig bis 230°C

heat-resistant up to 230°C

resistente al calor hasta 230 °C

résistant à la chaleur jusqu'à 230°C



	cm	↑ cm	€
13377	40 x 25	2	13,00
13378	48 x 32	2	15,20
13379	60 x 40	2	20,00



Mehlschaufel „PRO“

scoop

pala

pelle à farine

stehende Schaufel, auch für Flüssigkeiten geeignet

standing scoop, also applicable for liquids

pala, ápto también para líquidos

adaptée pour poudres et liquides



	cm	↑ cm	ltr.	€
00610	25 x 9	4,5	0,25	2,90
00611	31 x 12	5,5	0,5	3,50
00612	35 x 13	6,0	0,7	5,10



Teigspatel / Stielschaber

dough spatula / handle scraper

espátula masa / rascador

spatule à pâte / raclette

Aufhängeloch

with hanging hole

con agujero para colgar

avec trou de suspension



	→ cm	€
88950	25,5	10,00
88951	35,5	12,00



Backform

baking pan
marco pastelero
forme à gateaux

stufenlos verstellbar, aus flexiblem Edelstahl

adjustable, made of flexible stainless steel
ajustable, de acero inoxidable flexible
ajustable, en acier inox flexible



	cm	↑ cm	€
00042	19 x 28 - 34 x 54	5	17,90



Anwendungsbeispiel
application example



Tortenring

cake setting ring
aro de tarta
cercle à gateaux

stufenlos verstellbar

adjustable
ajustables
ajustables



	Ø cm	↑ cm	€
00040	16,5 - 32	7	8,40



Anwendungsbeispiel
application example



Schaumspeisering

mousse ring
aro redondo para semifríos
cercle à mousse rond

matt poliert, fugenlos

matt polished, seamless
pulido mate, sin soldadura
poli mat, sans soudure



	Ø cm	↑ cm	€
00098	6	4,5	3,20
00099	7	4,5	3,70
00092	8	4,5	3,80
00093	10	4,5	5,30
00094	12	4,5	7,00



Schaumspeiseringe, 5er Set

mousse ring, 5 pcs.
juego aros para emplatar o para semifríos
jeu de cercles à mousse inox, ronds

5-teilig: 4 Formen + 1 Verdichter, matt poliert, fugenlos

5 pcs. set: 4 shapes and 1 pusher, matt polished, seamless

juego de 5 piezas: 4 aros redondos y 1 pulsador, para dar forma, satinado sin soldadura

jeu de 5 pièces: 4 cercles et 1 poussoir. Idéal pour dressage sur assiette ou mousse, poli mat, sans soudure



	Ø cm	↑ cm	pcs.	€/ set
00110	6	4,5	5	17,60
00113	8	4,5	5	19,00

MEASURING CUPS



Messbecher „PRO“

measuring cup
jarra graduada
pichet gradué



mit geschlossenem Griff, mit geprägter Maßskalierung außen, l- und ml-Liter-Einteilung
with closed handle, with stamped printed liter and ml scale
con asa cerrada, con escala estampada de litros y ml
avec poignée fermée, avec échelle en litres et ml imprimée et tamponnée

	Ø cm	↑ cm	ltr.	€
30046	9	14,0	0,5	3,40
30047	12	16,5	1,0	4,50
30048	15	20,5	2,0	7,80
30049	17	23,5	3,0	10,00
30057	20	25,5	5,0	12,60



einfaches Eingießen
easy pouring



Messbecher „STACKABLE“

measuring cup
jarra graduada
pichet gradué



mit offenem Griff und geprägter Maßskalierung außen, platzsparend stapelbar

with open handle and embossed dimension scaling on the outside, space-saving stackable
con asa abierta y escala de dimensiones en relieve en el exterior, apilable para ahorrar espacio
avec une poignée ouverte et une échelle de dimensions en relief à l'extérieur, empilable et peu encombrante

	Ø cm	↑ cm	ltr.	€
30059	7	12,0	0,25	2,50
30061	9	14,0	0,5	3,10
30062	12	16,5	1,0	4,10
30063	15	20,5	2,0	7,20



offener Griff einfaches Eingießen stapelbar
open handle easy pouring stackable



Rührbecher mit Deckel „MIXUP“

stirring cup with lid
vaso agitador con tapa
tasse à remuer avec couvercle



inklusive Spritzschutz und geprägter Maßskalierung außen, platzsparend stapelbar

included splash guard with open handle and embossed dimension scaling on the outside, space-saving stackable
protección contra salpicaduras incluida con asa abierta y escala de dimensiones en relieve en el exterior, apilable para ahorrar espacio

protection contre les éclaboussures incluse avec une poignée ouverte et une échelle de dimensions en relief à l'extérieur, empilable et peu encombrante

	Ø cm	↑ cm	ltr.	Farbe / Colour	€
30072	12,5	16	1	french grey	7,90
30058	12,5	16	1	transparent	7,90



Griff mit Daumenmulde mit Silikonring inklusive Spritzschutz
handle with thumb recess with silicone ring inclusive splash guard



Messbecher
graduated jug
jarra graduada
pichet gradué



außen hochglanzpoliert, innen matt poliert, mit Maßskalierung außen
outside mirror polished, inside matt polished, with stamped liter scale
exterior pulido brillante, interior pulido mate con escalado en litros
extérieur poli brillant, intérieur poli mat, graduation en litres

	Ø cm	↑ cm	ltr.	€
30045	10	14	1	13,40



SQUEEZE BOTTLES



Quetschflasche

squeeze bottle
bote dosificador flexible
bouteille verseuse souple

mit Schraubdeckel und Verschlusskappe, ideal für Dressing und Saucen

with tight-screw and cap, ideal for dressing and sauce

con tapa de rosca y tapón, ideal para aliño y salsas

avec couvercle à visser et bouchon de fermeture, idéal pour vinaigrette et sauces



	Ø cm	↑ cm	ltr.	Farbe / Colour	€
93259	8	26,5	1,025		2,30
93260	8	26,5	1,025		2,30
93261	8	26,5	1,025		2,30



große Öffnung
big mouth opening



Quetschflasche

squeeze bottle
bote dosificador flexible
bouteille verseuse souple

mit Schraubdeckel und Verschlusskappe, ideal für Dressing und Saucen

with tight-screw and cap, ideal for dressing and sauce

con tapa de rosca y tapón, ideal para aliño y salsas

avec couvercle à visser et bouchon de fermeture, idéal pour vinaigrette et sauces



	Ø cm	↑ cm	ltr.	Farbe / Colour	€
93155	6,5	24	0,65		1,90
93156	6,5	24	0,65		1,90
93157	6,5	24	0,65		1,90



Quetschflasche, 6er Set

squeeze bottle, 6 pcs.
bote dosificador flexible, set de 6
bouteille verseuse souple, set de 6



mit Schraubdeckel und Verschlusskappe, ideal für Dressing und Saucen

with tight-screw and cap, ideal for dressing and sauce
con tapa de rosca y tapón, ideal para aliño y salsas
avec couvercle à visser et bouchon de fermeture, idéal pour vinaigrette et sauces

	Ø cm	↑ cm	ltr.	Farbe / Colour	pcs.	€ / set
93250	5	18,0	0,26		6	7,40
93251	5	18,0	0,26		6	7,40
93252	5	18,0	0,26		6	7,40
93253	7	20,0	0,49		6	10,20
93254	7	20,0	0,49		6	10,20
93255	7	20,0	0,49		6	10,20
93256	7	26,5	0,76		6	11,60
93257	7	26,5	0,76		6	11,60
93258	7	26,5	0,76		6	11,60



mit Verschlusskappe
with cap



große „Öffnung“
big „mouth opening“



Quetschflasche

squeeze bottle
bote dosificador flexible
bouteille verseuse souple



ideale Größe, um Speiseteller mit Saucen zu verzieren, mit Verschlusskappe

ideal size to garnish plates with sauces, with cap
tamaño ideal para decorar platos con salsas, con tapón
taille idéale pour décorer assiettes avec des sauces, avec bouchon

	Ø cm	↑ cm	ltr.	€
93154	5	16	0,2	1,50
93163	6	21	0,35	2,40



Quetschflasche „MINI“, 4er Set

squeeze bottle, 4 pcs.
bote dosificador flexible, 4 pz.
bouteille verseuse souple, 4 pc.



mit Schraubdeckel und Verschlusskappe, ideal für Dressing und Saucen

with tight-screw and cap, ideal for dressing and sauce
con tapa de rosca y tapón, ideal para aliño y salsas
avec couvercle à visser et bouchon de fermeture, idéal pour vinaigrette et sauces

	Ø cm	↑ cm	ltr.	pcs.	€ / set
93225	3,0	8,5	0,03	4	5,50
93226	3,5	9,5	0,05	4	5,90

PIZZA PANS



9 sizes



Pizzaform

pizza pan
molde de pizza
moule à pizza



Blaublech, nicht beschichtet, lange Lebensdauer, hitzebeständig bis 360 °C
blue steel, without coating, long endurance, heat resistant up to 360 °C
chapa azul, sin revestimiento, larga vida útil, resistente al calor hasta 360 °C
métal, sans revêtement, longue durée de vie, à la chaleur jusqu'à 360 °C

	∅ cm	↑ cm	€
73502	16 - 18	2,5	4,00
73505	22 - 24	2,5	6,70
73506	24 - 26	2,5	7,20
73507	26 - 28	2,5	7,50
73508	28 - 30	2,5	7,90
73509	30 - 32	2,5	8,40
73510	34 - 36	2,5	8,60
73511	38 - 40	2,5	10,40
73513	48 - 50	3,0	15,50



stapelbar
stackable



Pizzaform

pizza pan
molde de pizza
moule à pizza



Blaublech, rechteckig, Rand umgelegt, hitzebeständig bis 360 °C
blue steel baking sheet, rectangular, heat resistant up to 360 °C
chapa azul rectangular, borde plagado, resistente al calor hasta 360 °C
métal, rectangulaire, bord plié, à la chaleur jusqu'à 360 °C

	cm	↑ cm	€
88256	60 x 40	2,5	26,00



Gestell für Pizzaformen

rack for pizza pans
rejilla para pizzas
support pour moules à pizza



**zusammenklappbar für Pizzaformen Ø 28 cm,
Abstand zwischen den Ebenen 5,5 cm**

foldable rack for pizza dishes ø 28 cm,
distance between the levels 5.5 cm
rejilla plegable de para moldes de pizza de Ø 28 cm,
distancia entre los niveles 5,5 cm
support en pliable pour les moules à pizza de Ø 28 cm,
distance entre les niveaux 5,5 cm

	cm	↑ cm	€
73515	26 x 25	26	7,60



backofengeeignet
suitable for oven



Pizzaform für Ø 28 cm
pizza dish for Ø 28 cm

Pizzaform
pizza pan
molde de pizza
moule à pizza



	Ø cm	↑ cm	mm	€
73507	26 / 28	2,5	1	7,50



Pizzaschaufel
pizza peel
pala de pizza
pelle à pizza



	cm	→ cm	€
88080	35 x 30,5	90	39,20
88081	35 x 30,5	130	47,30



Teig- und Pizzaballenbehälter
dough and pizza ball container
recipiente para masa y bolas de pizza
récipient à pâte et boules à pizza



Innenmaß 56,5 x 36,5 cm, H: 8,5 cm
inner dimension 56,5 x 36,5 cm, H: 8,5 cm
medida interior 56,5 x 36,5 cm, H: 8,5 cm
dimension intérieure 56,5 x 36,5 cm, H: 8,5 cm

	cm	↑ cm	ltr.	€
82442 <small>NEW</small>	60 x 40	9	17	14,00
82440	60 x 40	7	13	12,00



stapelbar
stackable

passender Deckel
fitting lid
tapa adecuada
couverture approprié



	cm	↑ cm	€
82441	60 x 40	1	10,00



Mehlschaufel „PRO“

scoop
pala
pelle à farine
stehende Schaufel, auch für Flüssigkeiten geeignet
standing scoop, also applicable for liquids
pala, ápto también para líquidos
adaptée pour poudres et liquides



	cm	↑ cm	ltr.	€
00610	25 x 9	4,5	0,25	2,90
00611	31 x 12	5,5	0,5	3,50
00612	35 x 13	6	0,7	5,10



Teigschaber / Abstecher „TOOLTIME“

dough scraper
corta pasta
coupe-pâte
starre Edelstahlklinge
rigid blade stainless steel
hoja rígida de acero inoxidable
lame rigide inox



	cm	€
88930	15,5 x 8	5,20



Backhandschuhe

baking mittens
manoplas de panadero
gants de boulanger

Leder, gefüttert, Einheitsgröße, mit Stulpen, extrem hitzebeständig bis 250°C
leather, inner lining, one size, with cuffs, extremely heat resistant up to 250°C
cuero interior forrado, talla única, resiste a temperaturas hasta 250°C
cuir intérieur doublé, taille unique, résiste à maxi 250°C

	→ cm	€
88090	45	28,00



Korkuntersetzer

cork mat
salvamanteles
dessous-de-plat liège

ideal für Servier- und Eisenpfannen

ideal for iron pan

ideal para servir en sartenes de chapa

idéal pour présenter les poêles forgées sur table

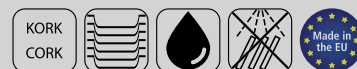

	Ø cm	↑ cm	€
73750	24	2	15,40



Pizzaschneider „TOOLTIME“

pizza cutter
cortador de pizza
coupe-pizza

ergonomischer Griff

ergonomic handle

mango ergonómico

manche ergonomique



	Ø cm	→ cm	€
88949	10	20	6,70



Pizzaroller „TOOLTIME“

pizza cutter
cortador de pizza
roulette à pizza



	Ø cm	→ cm	€
88829	6	18,5	4,80



Salatbesteck „OLIVE“, 2er Set

spoon, 2 pcs.
cuchara, set de 2
cuillère, set de 2

aus Olivenholz
olive wood
madera de olivo
en bois d'olivier



	cm	→ cm	€ / set
00841	9,5 x 8,5	17,0	17,30
00842	7,5 x 6,0	22,5	11,00



Anwendungsbeispiel
application example



Anwendungsbeispiel
application example



Löffel „OLIVE“

spoon
cuchara
cuillère

aus Olivenholz, ideal für Reis, Gemüse...
olive wood, ideal for rice, vegetables...
madera de olivo, ideal para arroz, verduras...
en bois d'olivier, idéal pour le riz, les légumes...



	cm	→ cm	€
00840	9,5 x 8,5	17	16,00



Schaufel „OLIVE“

scoop
pala
pelle

aus Olivenholz, ideal für Gewürze, Körner etc.
olive wood, ideal for spices, grains etc.
madera de olivo, ideal para especias, granos etc.
en bois d'olivier, idéal pour les épices, céréales, etc.



	→ cm	€
01020	13,5	7,40





Löffel „OLIVE“, 2er Set

spoon, 2 pcs.
cuchara, set de 2
cuillère, set de 2

aus Olivenholz, ideal für Gewürze
olive wood, ideal for spices
madera de olivo, ideal para especias
en bois d'olivier, idéal pour les épices



	→ cm	pcs.	€ / set
01018	14	2	6,60



Honiglöffel „OLIVE“

honey spoon
cuchara de miel
cuillère à miel

aus Olivenholz
olive wood
madera de olivo
en bois d'olivier



	→ cm	€
01019	15	4,90



Löffel „ACACIA“

spoon
cuchara
cuillère

aus Akazienholz, ideal für Reis, Gemüse...
acacia wood, ideal for rice, vegetables...
madera de acacia, ideal para arroz, verduras...
bois d'acacia, idéal pour le riz, les légumes...



	cm	→ cm	€
00599	9 x 6,5	23,5	5,50



Löffel

spoon
cuchara
cuillère

Nanmu Holz / nanmu wood / madera de nanmu / bois de nanmu



	cm	→ cm	€
87027	3,5 x 3	10	3,00



DELICATESSEN SPOONS



Feinkost- / Olivenlöffel, 6er Set

delicatessen / olives spoon, 6 pcs.
cuchara gourmet / para aceitunas, set de 6
cuillère gourmet / à olives, set de 6



geloht
perforated
perforadas
perforées

	cm	→ cm	pcs.	Farbe / Colour	€ / set
88598	6 x 9	27	6	■	12,00



Feinkostlöffel, 6er Set

delicatessen spoon, 6 pcs.
cuchara gourmet, set de 6
cuillère gourmet, set de 6



aus Kunststoff
plastic
plástico
plastique

	Ø cm	→ cm	pcs.	Farbe / Colour	€ / set
88627	6	23	6	■	10,00
88628	6	23	6	■	10,00



Dressinglöffel

dressing spoon
cuchara de aliño
cuillère à sauce



aus Kunststoff
plastic
plástico
plastique

	Ø cm	→ cm	ml.	Farbe / Colour	€
88636	6	34	50	■	3,90
88609	6	34	50	■	3,90



Schneidbrettständer
cutting board rack
soporte para tablas
rack pour planches à découper

für 6 Schneidbretter bis 25 mm Stärke
for 6 chopping boards up to 25 mm thickness
para 6 tablas de corte de 25 mm
pour 6 planches de 25 mm



	cm	↑ cm	€
88903	27 x 31	28	31,00



Eiswaffel-Ständer
cornet stand
soporte cucuruchos
support à cornets

matt poliert, mit 4 Löchern, 2 x Ø 31 mm + 2 x Ø 26 mm
matt polished, with 4 holes, 2 x Ø 31 mm + 2 x Ø 26 mm
pulido mate, con 4 agujeros 2 x Ø 31 mm + 2 x Ø 26 mm
poli mat, 4 trous - 2 x Ø 31 mm + 2 x Ø 26 mm



	cm	↑ cm	€
11881	27,5 x 9,5	9	20,90



Eisportionierer
ice cream scoop
cuchara para helado
cuillère à glace

hochglanzpoliert, mit Edelstahlfeder (physikalisch bedingt nicht korrosionsbeständig)
mirror polished, spring steel, spring is not stainless
pulido brillante, muelle de acero especial, no resistente al óxido
poli brillant, ressort acier spécial, non résistant à l'oxydation



	Ø cm	→ cm	ltr.	€
71006	6,5	23,5	1/12	11,60
71005	6,0	22,5	1/16	11,60
71004	5,5	22,0	1/20	11,60
71003	5,0	22,0	1/24	11,60
71002	5,0	21,5	1/30	11,60
71001	4,5	21,0	1/36	11,60



Flambierbrenner
chefs blow torch
soplete de cocina para flambeo
chalumeau de cuisine

mit handelsüblichem Feuerzeuggas auffüllbar, Flamme einstellbar bis ca. 1300° C,
Brenndauer von mindestens 60 Minuten

to be filled with commercial lighter gas, flame adjustable up to approx. 1300° C,
burning time of at least 60 minutes
rellenable con gas de mechero comercial, llama ajustable hasta 1300° C,
tiempo de combustión de al menos 60 minutos
rempli avec gaz pour briquet commercial, flamme réglable jusqu'à 1300° C,
temps de combustion d'au moins 60 minutes



	Ø cm	↑ cm	€
77315	4,5	16,5	33,00



Anwendungsbeispiel
application example



Rezeptionsglocke

ring bell
timbre
sonnette



	∅ cm	↑ cm	€
71400	8,5	6,0	6,20
71433	10,0	6,5	7,80



Bonspieß

bill spike
pinchanotas
pique-bons



Spieße aus flexiblem Kunststoff, mit stumpfen Enden zur Unfallverhütung
spikes made of flexible plastic, with blunt ends to prevent accidents
pinchos de plástico flexible
piques en plastique flexible

	cm	↑ cm	€
88855	9 x 5,5	10,5	3,80



Bonleiste

bill rail
portafichas
barre porte-bons



Bonleiste matt poliert, mit Glaskugel-Greifsystem, zur Wandmontage geeignet, auch mit Magneten nutzbar, inklusive Befestigungsmaterial

bill rail matt polished, with glass ball gripping system, suited for wall fastening, can also be used with magnets, mounting material included

portafichas pulido mate, con sistema de agarre de bolas de cristal, apto para montaje en pared, también se puede utilizar con imanes, material de fijación incluido

barre porte-bons poli mat, avec système de préhension par billes de verre, adapté au montage mural, également utilisable avec des aimants, matériel de fixation inclus

	cm	↑ cm	€
88900	40 x 8	2	17,00
88901	50 x 8	2	18,40
88902	60 x 8	2	20,00



Magnet-Messerhalter

magnetic knife rack
barra magnética para cuchillos
barre aimantée pour couteaux



mit 2 Magnetschienen und Haken, aus massivem Kunststoff, zur Wandmontage geeignet, Lieferung ohne Deko

with 2 magnet racks and hooks, strong plastic, suited for wall fastening

con 2 railes magnéticos y ganchos, plástico macizo, fijación en pared

avec 2 rails aimantés et crochets, plastique robuste, fixation murale

	→ cm	€
88911	45	11,20
88912	60	13,60



einhängbar
hookable

Panierstation, 3-teilig

breeding set, 3 pcs. set
estación de empanado, set de 3
station de panure, set de 3

zum Panieren von Fleisch, Gemüse, Käse etc.

for breading meat, vegetables, cheese etc.

para empanar carne, verduras, queso, etc.

pour paner la viande, les légumes, le fromage etc.



	cm	↑ cm	€ / set
66904	45,5 x 18	2,5	14,00



Zitronenschnitzelpresse

lemon slice squeezer

pinza exprimelimon

pinza presse citron

hochglanzpoliert, zum Auspressen von Zitronenscheiben / mirror polished, to press lemon slices

/ pulido brillante, para rodajas de limón / poli brillante, pour citrons en rondelle



	cm	€
71430	8 x 7	1,50



Zitruspresse

citrus squeezer

exprimidor cítricos

presse-citron

hochglanzpoliert, 2-teilig / mirror polished, 2 pcs. / pulido brillante, 2 piezas / poli brillante, 2 pièces



	Ø cm	↑ cm	ltr.	€
71431	12 / 17	10,5	0,35	13,80



88288

Folien-Abreißvorrichtung

clingfilm tear-off-dispenser

dispensador de film

dérouleur de film

mit Abreißkante / Säge-Messer, für Endlosfolie, als Tischgerät oder Wandgerät verwendbar

with saw, for endless rolls, can be fixed on the wall

con sierra para rollo de film continuo, se puede fijar en la pared

avec lame dentée pour rouleau de film, peut être fixé au mur



	cm	↑ cm		€
88288	34 x 16	9	für Folienbreite 30 cm / for film width 30 cm para film ancho 30 cm / pour film largeur 30 cm	41,00
88287	49 x 16	9	für Folienbreite 45 cm / for film width 45 cm para film ancho 45 cm / pour film largeur 45 cm	46,00



63 cm

30 cm

klappbar
folding

Aufsteller „ACHTUNG RUTSCHGEFAHR“

stand

letrero

panneau



	cm	↑ cm	€
71421	30 x 63	63	8,90





Covers & Accessories

COOLERS.....	.611
COVERS FOR CAKE PLATES.....	.607
GN COVERS.....	.600
LIDS.....	.609
PLATE COVERS.....	.605
ROLLTOP COVERS.....	.602
SUPER DOME.....	.606

GN KUPPELHAUBEN



GN Kuppelhaube

GN cover
GN cúpula
GN cloche bombée

glasklarer Kunststoff, Griff aus Zinkdruckguss

crystal clear plastic, die-cast zinc knob

plástico transparente, asa de zinc fundido a presión

plastique transparente, poignée en zinc moulé sous pression



	cm	↑ cm	GN		€
11021	33 x 28	17	1/2	geschlossen / totally closed cerrada / totement fermée	29,00
11022	33 x 28	17	1/2	mit Front-Ausschnitt / one long side cut out gran apertura frontal grande ouverture frontale	32,00
11026	54 x 33	20	1/1	geschlossen / totally closed cerrada / totement fermée	52,00
11027	54 x 33	20	1/1	mit Front-Ausschnitt / one long side cut out gran apertura frontal grande ouverture frontale	54,00
11028	54 x 33	20	1/1	mit seitlichem Ausschnitt one small side cut out pequeña apertura lateral petite ouverture latérale	54,00





11070 GN 1/1



11071 GN 1/1



11072 GN 1/1



11073 GN 1/2



11074 GN 1/2

GN Kuppelhaube

GN cover

GN cúpula

GN cloche bombée

glasklarer Kunststoff, Griff aus Zinkdruckguss

crystal clear plastic, die-cast zinc knob

plástico transparente, asa de zinc fundido a presión

plastique transparente, poignée en zinc moulé sous pression



	cm	↑ cm	GN		€
11070	54 x 33	20	1/1	geschlossen / totally closed cerrada / totalement fermée	52,00
11071	54 x 33	20	1/1	mit Front-Ausschnitt / one long side cut out gran apertura frontal grande ouverture frontale	54,00
11072	54 x 33	20	1/1	mit seitlichem Ausschnitt one small side cut out pequeña apertura lateral petite ouverture latérale	54,00
11073	33 x 28	17	1/2	geschlossen / totally closed cerrada / totalement fermée	29,00
11074	33 x 28	17	1/2	mit Front-Ausschnitt / one long side cut out gran apertura frontal grande ouverture frontale	32,00



ROLLTOPHAUBEN



GN Rolltophaube
GN rolltop cover
GN campana rolltop
GN cloche rolltop



patentiert, passend für GN-Behälter, -Tablets, etc., leichtgängig auf- und zuklappbar 90°
patented, suitable for GN containers, GN trays, etc. 90° opening
patentada, para cubetas GN, bandejas GN, etc. fácil de abrir y cerrar 90°
brevetée, pour bacs GN, plateaux GN, etc. s'ouvre et se ferme facilement à 90°

	cm	↑ cm	GN	€
11060	53,0 x 32,5	19	1/1	64,00
11061	32,5 x 26,5	15	1/2	59,00

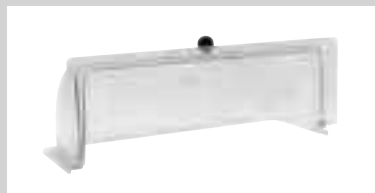

Designgriff
design handle



GN 1/1 Rolltophaube
GN 1/1 rolltop cover
GN 1/1 campana rolltop
GN 1/1 cloche rolltop



patentiert, passend für GN-Behälter, -Tablets, etc., leichtgängig auf- und zuklappbar 90°
patented, suitable for GN containers, GN trays, etc. 90° opening
patentada, para cubetas GN, bandejas GN, etc. fácil de abrir y cerrar 90°
brevetée, pour bacs GN, plateaux GN, etc. s'ouvre et se ferme facilement à 90°

	cm	↑ cm	GN	€
11075	53,0 x 32,5	19	1/1	62,00



GN Rolltophaube
GN rolltop cover
GN campana rolltop
GN cloche rolltop



patentiert, passend für GN-Behälter, -Tablets, etc., leichtgängig auf- und zuklappbar 90°
patented, suitable for GN containers, GN trays, etc. 90° opening
patentada, para cubetas GN, bandejas GN, etc. fácil de abrir y cerrar 90°
brevetée, pour bacs GN, plateaux GN, etc. s'ouvre et se ferme facilement à 90°

	cm	↑ cm	GN	€
11010	53,0 x 32,5	19	1/1	64,00
12010	32,5 x 26,5	15	1/2	59,00

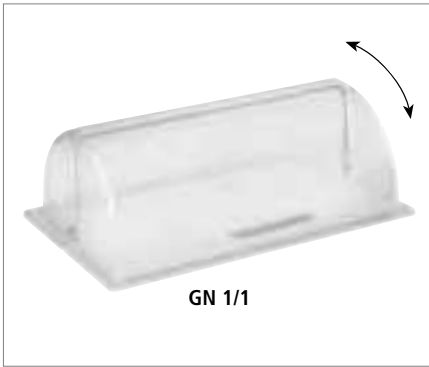

GN 1/1 Rolltophaube „SUNDAY“

GN 1/1 rolltop cover
GN 1/1 campana rolltop
GN 1/1 cloche rolltop



patentiert, passend für GN-Behälter, -Tablets, etc., leichtgängig auf- und zuklappbar 90°
patented, suitable for GN containers, GN trays, etc. 90° opening
patentada, para cubetas GN, bandejas GN, etc. fácil de abrir y cerrar 90°
brevetée, pour bacs GN, plateaux GN, etc. s'ouvre et se ferme facilement à 90°

	cm	↑ cm	GN	€
11016	53,0 x 32,5	19	1/1	64,00



GN 1/1 Rolltophaube

GN 1/1 rolltop cover
GN 1/1 campana abatible
GN 1/1 cloche basculante



patentiert, passend für GN-Behälter, -Tablets, etc., leichtgängig auf- und zuklappbar 90°
patented, suitable for GN containers, GN trays, etc. 90° opening
patentada, para cubetas GN, bandejas GN, etc. fácil de abrir y cerrar 90°
brevetée, pour bacs GN, plateaux GN, etc. s'ouvre et se ferme facilement à 90°

	cm	↑ cm	GN	€
11018	53,0 x 32,5	19	1/1	64,00



Rolltophaube

rolltop cover
campana abatible
cloche basculante



glasklarer Kunststoff, leichtgängig auf- und zuklappen 90°
solid quality, to be opened 90°
plástico transparente, apertura 90°
plastique transparent résistant, ouverture 90°

	Ø cm	↑ cm		€
18389	38	20	verchromter Griff / chrome plated handle pomo cromado / bouton chromé	23,00
18388	38	20	mit verchromtem Kugelgriff / with chrome plated handle con pomo cromado / avec bouton chromé	24,00
18387	38	20	mit vergoldetem Kugelgriff / gold plated handle pomo dorado / bouton doré	24,00
09023	38	20	mit verchromtem Zylindergriff / chrome plated handle pomo cromado / bouton chromé	24,00
18380	50	26	mit verchromtem Zylindergriff / chrome plated handle pomo cromado / bouton chromé	62,00

PROFIHAUBEN

11042
GN 1/1

11041
GN 1/2



GN Abdeckhaube

GN cover
GN cubierta
GN cloche



passend für GN Tablett, glasklarer Kunststoff, nahezu bruchfest

suitable for GN trays, clear plastic, nearly unbreakable

apto para bandejas GN, plástico transparente, muy resistente a la rotura

pour bacs et plateaux GN, plastique transparent, très résistant à la casse

	cm	↑ cm	✂ mm	GN	€
11043	32,5 x 17,6	10,5	3	1/3	17,00
11044	53,0 x 16,2	10,5	3	2/4	23,00

	cm	↑ cm	✂ mm	GN	€
11041	32,5 x 26,5	9,5	3	1/2	23,00
11042	53,0 x 32,5	9,5	3	1/1	32,00



stapelbar
stackable



GN 1/1 Haube „HOCHSTAPLER“

GN 1/1 cover
GN 1/1 campana
GN 1/1 cloche



glasklarer Kunststoff, Tablett fixiert sich auf der Haube - kein Rutschen möglich, nahezu bruchfest

clear plastic, tray fixes itself on the cover and can not slip off, nearly unbreakable

plástico transparente, la bandeja se fija a la tapa para que no se deslice, muy resistente a la rotura

en plastique transparent, le plat se fixe sur le dessous de la cloche pour ne pas glisser, très résistant à la casse

	cm	↑ cm	GN	fits to	€
11305	53,0 x 32,5	9	1/1	11295, 11300	30,00



GN 1/1 Haube

GN 1/1 cover
GN 1/1 campana
GN 1/1 cloche



klappbar, passend für GN 1/1-Behälter, GN 1/1-Tablett, etc., nahezu bruchfest

suitable for GN 1/1 chafing dish, GN 1/1 trays, GN 1/1 pans

plegable, para cubetas GN 1/1, bandejas GN 1/1 etc., muy resistente a la rotura

pliable, pour bacs GN 1/1, plateaux GN 1/1 etc., très résistant à la casse

	cm	↑ cm	GN	€
11013	53,0 x 32,5	6	1/1	29,00

**Frischhaltehaube**cover
campana
cloche

	Ø cm	↑ cm	fits to	€
11055	23	12	00825, 00848, 30148, 30334	6,00

glasklar, schwere stabile Ausführung
clear, heavy stable quality**Frischhaltehaube**cover
campana
cloche

	cm	↑ cm	fits to	€
11056	25 x 12	10	00826, 00849, 30149, 30338, 85099	6,00

glasklar, schwere stabile Ausführung
clear, heavy stable quality**Frischhaltehaube**cover
campana
cloche

	cm	↑ cm	€
06401	29,5 x 13,5	10	4,00
06701	21,6 x 16,2	7	3,00

**Frischhaltehaube**cover
campana
cloche

	cm	↑ cm	€
18621	Ø 18,0	8,5	2,20
18121	35,5 x 24,5	7,5	6,80

SUPER DOME | COVERS



06525 Ø 30 cm

06525

00468

Frischhaltehaube „SUPER DOME“

cover
campana
cloche



schwere, glasklare Qualität

stable, crystal clear quality

muy resistente y transparencia cristalina

haute résistance et transparence

	Ø cm	↑ cm	€
06525	30	40	74,00

passende Servier- Tortenplatten / suitable cake stands / porta pasteles compatibles / présentoirs à gâteaux compatibles

	Ø cm	↑ cm	fits to	Farbe / Colour	€
00468	31	3,5	06525		18,40
33294	33	8,0	06525		74,00
33295	33	16,0	06525		100,00



Servierbeispiel
presentation example



Präsentationsmöglichkeiten
presentation examples



06519

Ø 21cm

06520

Ø 30cm

3 sizes available Ø 21/ 30 / 36 cm

Frischhaltehaube „DOME“

cover
campana
cloche



schwere, glasklare Qualität

stable, crystal clear quality

calidad estable y transparencia cristalina

qualité stable et clarté cristalline

	Ø cm	↑ cm	fits to	€
06519	21	17	33292, 33293	30,00
06520	30	22	00046, 00463, 00468, 00469, 00975, 00998, 15621, 15622, 33294, 33295, 83884, 83890, 83891, 84177, 84943, 84944	37,00
06521	36	27	00816, 33296, 33297	74,00



stapelbar
stackable



Präsentationsmöglichkeiten
presentation examples





06512

Frischhaltehaubecover
campana
cloche**glasklar, schwere stabile Ausführung, stapelbar**clear, heavy stable quality, stackable
transparente, alta estabilidad, apilable
transparente, très stable, empilable

	Ø cm	↑ cm		€
06512	30	11,5	mit verchromtem Griff / with chrom plated handle con botón cromado / avec bouton chromé	8,20
06517	33	12,5	mit verchromtem Griff / with chrom plated handle con botón cromado / avec bouton chromé	9,60



06515

Frischhaltehaubecover
campana
cloche**glasklar, schwere stabile Ausführung, stapelbar**clear, heavy stable quality, stackable
transparente, alta estabilidad, apilable
transparente, très stable, empilable

	Ø cm	↑ cm	€
06510	30	11,5	5,90
06515	33	12,5	7,50

stapelbar
stackable

06501

Frischhaltehaubecover
campana
cloche

	Ø cm	↑ cm	€
06501	30	11,0	4,20
06504	30	9,5	6,40
06506	30	7,0	4,10

**Frischhaltehaube**cover
campana
cloche bombée**glasklar, Griff aus 18/10 Edelstahl, schwere, stabile Ausführung**transparent, handle made of 18/10 stainless steel, heavy stable quality
transparente, mango de acero inoxidable 18/10, alta estabilidad
transparente, manche en acier inoxydable 18/10, anse chromée, très stable

	Ø cm	↑ cm	€
15351	20,5	10	12,00

PLATE COVERS



11051 Ø 22 cm



11052 Ø 24 cm



11053 Ø 28 cm



11054 Ø 28,5 cm

Tellerabdeckhaube
plate cover
cubierta para plato
couvertcle pour assiette



passend für unterschiedliche Tellergrößen

suitable for different plate sizes

aptas para diferentes tamaños de platos

aptes pour différentes tailles d'assiettes

	Ø cm	↑ cm	passend für Tellergrößen / suitable for plate sizes	€
11051	22,0	7,0	Ø 21,5 cm	4,50
11052	24,0	7,5	Ø 22,5 - 23,0 cm	4,80
11053	28,0	6,5	Ø 26,0 - 26,5 cm	6,80
11054	28,5	6,5	Ø 27,0 - 27,5 cm	7,50



Präsentationsmöglichkeit
presentation example



passende Hauben
suitable covers 11051, 11052



Deckel „PURE“ mit Löffelaussparung

cover with notched for spoons

tapa con espacio para la cuchara

couvre-cle avec encoche pour la louche



	cm	↑ cm	fits to	€
83600	19 x 19	1,5	79004, 79005, 83409, 83468, 84244, 85260, 85266	8,20
83601	25 x 25	1,5	83469, 83408, 84245, 84561, 84562, 85261, 85267	10,40



Deckel „FLOAT“ mit Löffelaussparung

cover, with notched for spoons

tapa con espacio para la cuchara

couvre-cle, avec encoche pour la louche



	cm	↑ cm	fits to	€
83921	19 x 19	1,3	83916, 83917	8,40
83922	25 x 25	1,3	83918, 83919	10,60



Deckel „FRIDA“

cover

tapa

couvre-cle



	Ø cm	↑ cm	fits to	€
84963	13	2,5	84605, 84606	3,40



Deckel „FRIDA“

cover

tapa

couvre-cle



	cm	↑ cm	fits to	€
84965	13 x 13,0	2,5	84936, 84937	3,10
84966	17 x 17,0	2,5	84558, 84559	3,40



Schutzdeckel mit Löffelaussparung

cover
tapa
couvercle



glasklar, klappbar, mit 10 Beschriftungsschildern

transparent, with 10 cards for inscription
plástico transparente, con 10 etiquetas para inscripción
plastique transparent, avec 10 étiquettes pour inscription

	Ø cm		€
11868	14,5	mit verchromtem Griff / chrome plated handle botón cromado / bouton chromé	12,00
11878	23,5	mit verchromtem Griff / chrome plated handle botón cromado / bouton chromé	12,60

Schilder, 10er Set / signs, 10 pcs. set / set de 10 cartelitos / set de 10 étiquettes

	fits to	€
11879	11878	5,20



Deckel klappbar mit Löffelaussparung

cover hinged
tapa con bisagra
couvercle avec charnière



glasklar, mit Designer-Griff, verchromt, ohne Beschriftungsschild

clear, with designer handle, chrome plated, without card for inscription
transparente, con pomo de diseño cromado, sin tarjetas para inscripción
transparent, avec bouton chromé de design, sans étiquette pour inscription

	Ø cm	fits to	€
10889	23,5	11817, 11818, 11845, 11847, 11849	12,00



Schale

bowl
cuenco
bol



	Ø cm	↑ cm	ltr.	VE / unit	€ / pc.
11859	6,0	2,5	0,05	36	2,00
11866	7,5	3,5	0,09	36	2,00
11865	14,0	6,5	0,50	6	3,30
11875	23,0	10,5	2,50	6	7,60



Kühlakku
cooler
acumulador de frío
accumulateur de froid



gefüllt mit Kühlflüssigkeit, nicht giftig, einfach im Gefrierfach einfrieren, unbegrenzt wiederverwendbar
freeze it in freezer, non toxic, filled with freezer-liquid, boundless reusable
se enfría en el congelador, no tóxico, se puede reutilizar sin límite
liquide eutectique qui accumule froid une fois dans le congélateur, non toxique, réutilisable sans limites

	Ø cm	↑ cm	Farbe / Colour	€
10777	15,0	2,5	White	5,40
10781	10,5	2,5	White	3,10
10661	10,5	2,0	White	3,40



Kühlakku
cooler
acumulador de frío
accumulateur de froid



	Ø cm	→ cm	Farbe / Colour	€
00615	7,5	11,5	Black	10,50



Kühlakku
cooler
acumulador de frío
accumulateur de froid



gefüllt mit Kühlflüssigkeit, nicht giftig, einfach im Gefrierfach einfrieren, unbegrenzt wiederverwendbar
freeze it in freezer, non toxic, filled with freezer-liquid, boundless reusable
se enfría en el congelador, no tóxico, se puede reutilizar sin límite
liquide eutectique qui accumule froid une fois dans le congélateur, non toxique, réutilisable sans limites

	cm	↑ cm	Farbe / Colour	€
10782	41 x 21,0	2,5	White	16,00
10791	25 x 19,0	2,5	White	8,40
11101	16 x 7,5	2,0	Blue	7,00



Aufsteller „ACHTUNG RUTSCHGEFAHR“
stand
letrero
panneau



	cm	↑ cm	Farbe / Colour	€
71421	30 x 63	63	Yellow	8,90

*Laser-Logo
Individual*

Laserlogo Individual

- perfekte Lasergravuren
- perfectly Laser engravings
- grabado perfecto por láser
- marquage laser parfait

≥ 10
pcs.



DE

- unverwechselbar
- einzigartig
- imagefördernd

Ihre individuelle Lasergravur von APS

Wir bieten Ihnen die Möglichkeit, unsere Produkte mit Ihrem individuellen Logo per Laser zu gravieren - einzigartig, unverwechselbar und bereits ab 10 Stück je Artikel. Die perfekte Beschriftung durch modernste Lasertechnologie ist spülmaschinenfest und somit dauerhaft auf allen Edelstahl- und Naturschieferprodukten, sowie auf versilberten und verchromten Metall-Artikeln umsetzbar. Machen Sie aus Ihren Gastronom-Behältern Ihre ganz persönlichen Unikate und werten Sie Ihre Servierartikel mit Ihrem eigenen Logo auf.

- geringe Mindestbestellmenge von nur 10 Stück
- kurze Lieferzeiten
- Logos bis zu einer Fläche von max. 10 x 10 cm realisierbar

ES

- único
- personalizado
- promotor de imagen

Grabado laser por APS

Podemos grabar su logo y así personalizar los productos APS a partir de mínimo 10 unidades por referencia. Gracias a la novedosa tecnología de grabado por láser, la inscripción es perfecta y resistente al lavavajillas. Se puede aplicar a los artículos en acero inoxidable, pizarra natural, metal cromado y plateado.

- cantidad mínima de solamente 10 unidades
- realización rápida
- tamaño de logos hasta máximo 10 x 10 cm

EN

- distinct
- unique
- image enhancing

Your individualised laser engraving by APS

We offer you the option of having your personalised logo engraved on our products - inimitable, unique, and available for delivery from only 10 pieces per product. The perfect inscription by use of the newest technology is dishwasher-safe and thus can be permanently applied to products made of stainless steel and natural slate, as well as silver-coated and chromed metal articles. Turn your gastronom container into your individual, one of a kind article and enhance your serving items with your own logo.

- minimum order quantity of only 10 pieces
- swift delivery
- feasible logos are those with a maximum size of 10 x 10 cm

FR

- unique
- original
- porteur d'image

Marcage laser par APS

Nous pouvons graver votre logo et ainsi personnaliser les produits APS à partir de 10 pièces par référence. Grâce à une technologie d'avant-garde de marquage par laser, l'inscription est parfaitement reproduite et résistante au lave-vaisselle. Ce type de marquage peut s'appliquer sur l'acier inoxydable, sur l'ardoise naturelle, sur le métal chromé ou argenté.

- quantité minimum de seulement 10 unités
- fabrication rapide
- taille du logo jusque 10 x 10 cm





APS – DIN EN ISO 9001

APS steht für höchste Qualitätsstandards und kontinuierliche Verbesserung.

Wir sind nach der internationalen Norm DIN EN ISO 9001 zertifiziert. Diese Zertifizierung bestätigt unser Engagement für ein effektives Qualitätsmanagement, transparente Abläufe und die stetige Optimierung unserer Prozesse.

APS – DIN EN ISO 9001

APS stands for the highest quality standards and continuous improvement.

We are certified according to the international standard DIN EN ISO 9001. This certification confirms our commitment to effective quality management, transparent procedures and the continuous optimisation of our processes.



APS – BSCI

APS engagiert sich für die Verbesserung von Arbeitsbedingungen.

Wir sind Partner der europäischen Organisation BSCI. Die „Business Social Compliance Initiative“ (BSCI) ist eine Initiative von Unternehmen zur Verbesserung der Arbeitsbedingungen in der globalen Versorgungskette.

APS – BSCI

APS is committed to the improvement of working conditions.

We are a partner of the European organisation BSCI. The 'Business Social Compliance Initiative' (BSCI) is an initiative of companies to improve working conditions in the global supply chain.



APS – Familienfreundliches Unternehmen

APS wurde als „Familienfreundliches Unternehmen“ im Hochsauerlandkreis zertifiziert.

Diese Auszeichnung verdeutlicht unser Engagement für die Vereinbarkeit von Beruf und Familie. Wir bieten flexible Arbeitsbedingungen und unterstützen unsere Mitarbeitenden dabei, Beruf und Privatleben in Einklang zu bringen.

APS – Familienfreundliches Unternehmen

APS has been certified as a family-friendly company in the Hochsauerland district.

This award confirms our commitment to reconciling work and family life. We offer flexible working conditions and support our employees in harmonising work and private life.

APS – Garantierte Qualität

APS-Produkte entsprechen den Richtlinien der Europäischen Kommission. Diese enthalten Bestimmungen für Materialien, welche mit Lebensmitteln in Berührung kommen. Wir arbeiten sehr eng mit Zertifizierungsinstitutionen und Prüflaboren zusammen und können somit die Lebensmittelsicherheit (LFGB Regulation) der APS-Artikel garantieren.

APS – Guaranteed quality

APS products comply with directives of the European Commission. This contains provisions for materials which come into contact with foodstuffs. We work very closely together with certification institutions and testing laboratories and are therefore able to guarantee the compatibility with foodstuffs (German LFGB regulation) of APS products.



Icon-Index



neuer Artikel
new item



Made in Germany



Made in the EU



GN-Größen
GN norm



spülmaschinengeeignet
dishwasher-proof



nicht spülmaschinen-geeignet
not dishwasher-proof



feucht abwaschbar
wet washable



mikrowellengeeignet
microwave-proof



nicht mikrowellen-geeignet
not microwave-proof



nicht für Backofen
not for baking oven



keine direkte Hitze
not direct heat



max. 40°C



kühlbar
for cooling



Antirutsch-Füßchen
non-slip feet



stapelbar
stackable



bruchsicher
shatter-proof



für Induktionsplatten
for induction use



360° drehbar
360° rotatable



Eigenmontage
self assembly



**nicht für Lebens-
mittelkontakt**
not food safe

Function-Index



RGB
Die RGB-Funktion ermöglicht anpassbare Lichtfarben in Rot, Grün und Blau für eine personalisierte Beleuchtung.

RGB
The RGB function allows customizable light colors through red, green, and blue, providing personalized illumination.



CCT
Die CCT-Funktion ermöglicht die Anpassung der Farbtemperatur, was eine variable Lichtstimmung von warmweiß zu kaltweiß ermöglicht.

CCT
The CCT function allows the colour temperature to be adjusted, enabling a variable lighting mood from warm white to cool white.



3-Stufen Dimmbar
Die 3-Stufen Dimmbarkeit bietet eine einfache Anpassung der Helligkeit in drei verschiedenen Stufen.

3-step dimmable
The 3-step dimming enables simple adjustment of the brightness in three different levels.



Fernbedienung
Die Fernbedienung ermöglicht die gleichzeitige Steuerung mehrerer Leuchten und bequeme Anpassung von Einstellungen aus der Ferne.

Remote control
The remote control enables simultaneous control of several lights and convenient adjustment of settings from a distance.



IP54
Der IP54-Standard kennzeichnet die Staub- und Spritzwasserbeständigkeit, was den Einsatz der Leuchten im Freien ermöglicht.

IP54
The IP54 standard indicates resistance to dust and splash water, allowing the lights to be used outdoors.



Leuchtdauer minimal
Großer Akku – geringer Verbrauch: Gibt die kürzeste Leuchtdauer bei maximaler Helligkeit an.

Minimum light duration
Large battery – low consumption: Indicates the shortest light duration at maximum brightness.



Leuchtdauer maximal
Großer Akku – geringer Verbrauch: Gibt die längste Leuchtdauer bei minimaler Helligkeit an.

Maximum light duration
Large battery – low consumption: Indicates the longest light duration at minimum brightness.



Ladedauer
Hohe Akkukapazität – effiziente Nutzung: Gibt die erforderliche Ladedauer für eine vollständige Aufladung an.

Charging time
High battery capacity – efficient use: Indicates the charging time required for a full charge.

Material-Index Metalle

material index metals



Material	Welding	Oil	Microwave	Dishwasher	Cold	Induction	Temp. Range
ALU ALUMINIUM Aluminium aluminium	—	✓	—	✓	✓	—	-20 +250 °C
BLAUBLECH BLUE STEEL Blaublech blue steel	—	✓	—	✓	✓	—	-20 +360 °C
EDELSTAHL STAINLESS INOX 18/10 Edelstahl 18/10 stainless steel 18/10	✓	✓	—	✓	✓	—	-20 +400 °C
EDELSTAHL STAINLESS INOX 18/8 Edelstahl 18/8 stainless steel 18/8	✓	✓	—	✓	✓	—	-20 +400 °C
EDELSTAHL STAINLESS INOX Edelstahl (unspezifisch) stainless steel (unspecific)	✓	✓	—	✓	✓	—	-20 +400 °C
EDELSTAHL STAINLESS INOX 18/0 Edelstahl 18/0 stainless steel 18/0	✓	✓	—	✓	✓	✓	-20 +400 °C
FE EISEN Eisen iron	—	✓	—	✓	✓	✓	-20 +400 °C
GUSS ZINK Gusseisen Zink cast iron zinc	—	✓	—	✓	✓	✓	-20 +400 °C
GUSSEISEN EMAILLIERT Gusseisen emailliert cast iron enamelled	—	✓	—	✓	✓	✓	-20 +400 °C
METALL Stahl steel	—	✓	—	—	✓	—	-20 +400 °C
METALL VERCHROMT verchromter Stahl chrome plated steel	—	✓	—	—	✓	—	-20 +400 °C

Material-Index Kunststoffe

material index plastics



Material	Description	Heat	Water	Microwave	Cold	Impact	BPA Free	Temp. Range
ABS KUNSTSTOFF	ABS - Acrylnitril-Butadien-Styrol ABS - acrylonitrile butadiene styrene	✓	✓	—	✓	✓	✓	+100 °C
ACRYL ACRYLIC	ACRYL - künstliches Harz ACRYL - artificial resin	—	✓	—	✓	✓	✓	-40 +50 °C
EPP EXPANDIERTES POLYPROPYLEN	EPP - expandiertes Polypropylen EPP - expanded polypropylene	✓	✓	—	✓	✓	✓	-40 +75 °C
EVA KUNSTSTOFF	EVA - Ethylenvinylacetat EVA - ethylene vinyl acetate	—	✓	—	✓	✓	✓	+60 °C
FIBER GLASS	GFK - glasfaserverstärkter Kunststoff GFK - glass fibre reinforced plastic	✓	✓	—	✓	✓	✓	+100 °C
original APS melamine	MF - Melamin MF - melamine	✓	✓	—	✓	✓	✓	-30 +70 °C
MS KUNSTSTOFF	MS - Kunststoff MS - plastic	—	✓	—	✓	✓	✓	+70 °C
PA POLYAMID	PA - Polyamid PA - polyamide	✓	✓	—	✓	✓	✓	+220 °C
PC POLYCARB.	PC - Polycarbonat PC - polycarbonate	✓	✓	✓	✓	✓	—	-40 +100 °C
PE POLYETHYL.	PE - Polyethylen PE - polyethylene	✓	✓	—	✓	✓	✓	-30 +120 °C
PET KUNSTSTOFF	PET - Polyethylenterephthalat PET - Polyethylene terephthalate	✓	✓	—	✓	✓	✓	-30 +55 °C
PP POLYPROPY.	PP - Polypropylen PP - polypropylene	✓	✓	✓	✓	✓	✓	-40 +75 °C
PS POLYSTYROL	PS - Polystyrol PS - polystyrene	✓	✓	—	✓	✓	✓	+70 °C
PVC KUNSTSTOFF	PVC - Polyvinylchlorid PVC - polyvinyl chloride	—	✓	—	✓	✓	✓	-50 +60 °C
SAN KUNSTSTOFF	SAN - Styrol-Acrylnitril SAN - styrene acrylonitrile	✓	✓	—	✓	✓	✓	+100 °C
SILIKON SILICON	Silikon silicone	✓	✓	✓	✓	✓	✓	-70 +180 °C
TR TRITAN	Tritan® Tritan®	✓	✓	—	✓	✓	✓	-30 +95 °C

Material -Index

BETON
CONCRETE

Beton

Werkstoff Beton, coole Optik; handgefertigt
Pflege:
nicht spülmaschineneeignet

Concrete

Concrete material, cool look; handmade
care:
not dishwasher safe

MARMOR
MARBLE

Marmor

Werkstoff Marmor, edle Optik; Naturstein
Pflege:
nicht spülmaschineneeignet

Marble

Marble material, elegant look; natural stone
care:
not dishwasher safe

PORZELLAN
PORCELAIN

Porzellan

hitzebeständig bis ca. +220 °C
Pflege:
spülmaschineneeignet

Porcelain

heat-resistant up to approx. +220 °C
care:
dishwasher safe

SCHIEFER
SLATE

Schiefer

Naturschiefer versiegelt
Pflege:
nicht spülmaschineneeignet

Slate

Natural slate sealed
care:
not dishwasher safe

GLAS
GLASS

Glas

hygienisch, geschmacksneutral, langlebig, mikrowelleneeignet
Pflege:
spülmaschineneeignet

Glass

hygienic, tasteless, durable, suitable for microwaves
care:
dishwasher safe

BAMBUS
BAMBOO

Bambus

lebensmittelecht; nicht spülmaschineneeignet; naturbedingte Abweichung in Form, Farbe, Maserung und Größe; Abweichungen stellen keinen Mangel dar

Pflege:

Vor dem ersten und nach jedem Gebrauch gründlich mit heißem Wasser und Spülmittel reinigen und nicht längere Zeit im Wasser liegen lassen. Anschließend gut abtrocknen und aufrecht trocknen lassen.

Bamboo

food-safe; not dishwasher-safe; natural deviations in shape, color, grain in shape, color, grain and size; deviations do not constitute a defect constitute a defect

care:

Clean thoroughly with hot water and washing-up liquid before the first and after each use and do not leave in water for a long time. for a long time. Then dry well and leave to dry upright.

HOLZ
WOOD

Holz

lebensmittelecht; nicht spülmaschineneeignet; naturbedingte Abweichung in Form, Farbe, Maserung und Größe; Abweichungen stellen keinen Mangel dar

Pflege:

Vor dem ersten und nach jedem Gebrauch gründlich mit heißem Wasser und Spülmittel reinigen und nicht längere Zeit im Wasser liegen lassen. Anschließend gut abtrocknen und aufrecht trocknen lassen.

Ihr Holzprodukt pflegen Sie in regelmäßigem Abstand mit etwas geschmacksneutralem und handelsüblichem Speiseöl.

Wood

food-safe; not dishwasher-safe; natural deviations in shape, color, grain in shape, color, grain and size; deviations do not constitute a defect constitute a defect

care:

Clean thoroughly with hot water and washing-up liquid before the first and after each use and do not leave in water for a long time. for a long time. Then dry well and leave to dry upright.

Care for your wooden product at regular intervals with a little tasteless and commercially available cooking oil.

1		10515	7	517	10766	3	130	11013	7	604	11542	2	44	11780	8	92	
10300	9	324, 338, 532	10516	4	517	10769	4	132	11016	8	74, 603	11543	9	44	11781	5	92, 105
10301	6	324, 338, 532	10517	1	517	10770	0	132	11018	2	34, 35, 397, 603	11546	0	40	11795	2	114
10302	3	324, 338, 532	10525	6	152, 516	10771	7	133	11020	5	147	11547	7	40	11805	8	107
10303	0	324, 338, 532	10526	3	516	10775	5	132	11021	2	49, 600	11555	2	398	11807	2	107
10305	4	325, 531	10527	0	516	10776	2	132	11022	9	600	11556	9	49	11810	2	47
10306	1	325, 531	10534	8	516	10777	9	45, 46, 47, 123, 611	11026	7	49, 398, 600	11557	6	66	11811	9	46, 47
10307	8	325, 531	10535	5	516	10778	6	109	11027	4	398, 402, 600	11558	3	66	11812	6	46, 47
10318	4	339, 533	10536	2	516	10781	6	611	11028	1	398, 600	11563	7	137, 525	11813	3	46
10319	1	339, 533	10540	9	518	10782	3	39, 140, 611	11040	0	147	11572	9	49	11815	7	47
10320	7	339, 533	10541	6	518	10788	5	127	11041	0	147, 196, 239, 600, 604	11573	6	49	11816	4	46, 47
10321	4	339, 533	10542	3	518	10789	2	127	11042	7	147, 196, 239, 402, 600, 604	11574	3	137, 525	11817	1	46, 610
10322	1	529	10543	0	518	10791	5	39, 40, 41, 44, 611	11043	4	147, 196, 239, 604	11575	0	137, 525	11818	8	46, 610
10323	8	529	10544	7	518	10792	2	130, 474	11044	1	67, 147, 196, 239, 604	11576	7	137, 525	11840	9	106
10325	2	529	10560	7	515	10795	3	126	11051	9	60, 608	11595	8	111, 112	11841	6	106
10326	9	529	10561	4	515	10796	0	126	11052	6	60, 608	11596	5	112	11845	4	45, 610
10327	6	529	10562	1	515	10800	4	122	11053	3	608	11597	2	112	11846	1	46, 47
10328	3	528	10563	8	515	10801	1	123	11054	0	608	11598	9	112	11847	8	47, 610
10329	0	528	10564	5	515	10802	8	121	11055	7	152, 537, 605	11599	6	112	11848	5	46, 47
10330	6	528	10565	2	514	10803	5	123	11056	4	63, 152, 241, 417, 537, 605	11616	0	38	11849	2	47, 610
10331	3	528	10566	9	514	10804	2	123	11060	1	73, 602	11617	7	38	11859	1	115, 610
10332	0	528	10567	6	514	10807	3	123	11061	8	73, 602	11619	1	140	11865	2	113, 610
10334	4	528	10568	3	514	10808	0	123	11065	0	147	11620	7	36, 38	11866	9	610
10335	1	528	10569	0	514	10809	7	123	11070	0	398, 402, 413, 601	11621	4	36, 37, 38	11868	3	46, 47, 113, 610
10336	8	528	10570	6	514	10812	7	123	11071	7	398, 402, 412, 413, 601	11622	1	37	11875	1	45, 112, 610
10350	4	528	10571	3	514	10814	1	123	11072	4	398, 402, 413, 601	11623	8	36	11878	2	45, 46, 47, 112, 610
10351	1	528	10572	0	514	10818	9	119	11073	1	72, 413, 601	11625	2	320	11879	9	348, 610
10355	9	529	10573	7	514	10830	1	127	11074	8	413, 601	11626	9	36, 38	11881	2	595
10360	3	529	10574	4	514	10833	2	127	11075	5	39, 40, 72, 140, 602	11627	6	36, 38	11884	3	81
10361	0	529	10585	0	515	10836	3	30, 126	11100	0	39, 147	11628	3	37	11885	0	81
10362	7	529	10586	7	515	10837	0	30, 126	11101	1	42, 43, 45, 611	11629	0	36	11885	0	81
10380	1	530	10587	4	515	10838	7	30, 126	11107	1	72, 413, 601	11645	0	39, 140	11887	4	51
10381	8	530	10588	1	515	10839	4	30, 126	11074	8	413, 601	11649	8	320	11888	1	51
10400	6	117, 119	10589	8	515	10840	0	127	11075	5	39, 40, 72, 140, 602	11650	4	320	11889	8	51
10403	7	117, 119	10661	1	46, 47, 611	10841	7	118, 119	11110	3	147	11651	1	320	11891	1	51
10404	4	117	10663	5	127	10849	3	117, 118, 119	11119	6	33, 262, 263	11671	9	139, 447	11901	7	435
10405	1	117	10668	0	109	10850	9	127	11150	9	146	11672	6	139, 447	11910	9	435
10409	9	120	10691	8	131	10851	6	119, 125	11155	4	146	11675	7	433	11915	4	435
10410	5	120	10692	5	131	10855	4	119	11244	5	441	11683	2	433	11916	1	435
10411	2	120	10693	2	131	10870	7	30, 121	11295	7	146, 604	11711	2	31	11917	8	435
10415	0	120	10695	6	131, 486	10871	4	30, 121	11300	8	146, 604	11712	9	31	11921	5	352
10416	7	120	10700	7	122	10872	1	30, 121	11305	3	146, 604	11719	8	37	11922	2	352
10417	4	120	10701	4	123	10873	8	30, 121	11411	1	76	11720	4	92	11930	7	354
10418	1	120	10703	8	123	10889	9	610	11414	2	76	11721	1	36	11931	4	354
10422	8	125	10704	5	123	10907	0	123	11444	9	76	11722	8	36	11940	6	467
10424	2	124, 125	10707	6	123	10910	0	138	11446	3	76	11723	5	36	11944	4	97, 386, 387, 460
10426	6	124, 125	10708	3	123	10911	7	138	11455	5	76	11724	2	36	11945	1	97, 386, 387, 460
10427	3	124	10709	0	123	10912	4	138	11495	1	110, 113	11726	6	292, 320	11946	8	97, 460
10428	0	124, 125	10710	6	123	10913	1	138	11496	8	113	11727	3	174, 292, 320	11947	5	97, 460
10430	3	125	10711	3	123	10914	8	138	11497	5	113	11728	0	75	11948	2	94, 463
10435	8	124	10712	0	123	10915	5	139	11498	2	113	11729	7	75	11949	9	94, 463
10440	2	126	10713	7	123	10916	2	139	11499	9	113	11747	1	352	11950	5	467
10450	1	118, 119	10714	4	123	10917	9	139	11503	3	39	11748	8	352	11951	2	94, 463
10451	8	118, 119	10715	1	123	10921	6	138	11505	7	39	11750	1	105, 351	11952	9	94, 463
10452	5	118, 119	10716	8	123	10922	3	138	11522	4	111	11752	5	93, 350, 421	11954	3	96, 462
10460	0	117, 119	10718	2	120	10923	0	138	11523	1	110, 111	11753	2	93, 350, 421	11955	0	29, 96, 97, 460, 462
10500	3	517	10718	2	120	10924	7	138	11524	8	110	11754	9	93, 350, 421	11960	4	96, 462
10501	0	124, 125, 517	10720	5	122	10924	7	138	11526	2	110	11755	6	351	11964	2	96, 462
10502	7	517	10721	2	130	10924	7	138	11527	9	110	11756	5	91	11965	9	94, 463
10503	4	517	10722	9	130	10924	7	138	11529	3	111	11767	9	91	11966	6	94, 394, 463
10503	4	517	10725	0	21, 129	10990	2	136, 524	11540	8	41	11770	9	91	11969	7	51
10504	1	517	10726	7	21, 129	10991	9	136, 298, 524	11541	5	41	11771	6	91	11970	3	107
10505	8	120	10727	4	21, 129	10992	6	136, 524				11775	4	137, 525	11971	0	109
10506	5	290, 519	10727	4	21, 129	10993	3	137, 525				11776	1	137, 525	11973	4	109
10510	2	516	10738	0	21, 128, 474	10994	0	137, 298, 525				11778	5	92	11975	8	107
10510	2	516	10739	7	128, 474	10995	7	136, 524									
10511	9	516	10748	9	133	10996	4	136, 524									
10512	6	516	10749	6	133	11000	0	147									
10513	3	517	10750	2	127	11010	6	39, 40, 41, 397, 602									
10514	0	517	10764	9	130												

11977	2	386, 387, 461	12940	5	32, 33, 35	14981	6	28	16007	1	522, 523	18387	2	44, 397, 603	30240	2	418
11978	9	457	12941	2	32	14987	8	29, 108	16008	8	523	18388	9	44, 45, 252, 397, 603	30250	1	418
11979	6	461	12990	0	487	14990	8	28	16009	5	522	18389	6	34, 397, 603	30260	0	577
11980	2	115	13122	4	155	14995	3	29	16010	1	522	18621	7	605	30263	1	577
11998	7	95, 464	13377	8	582	15215	1	247	16011	8	522				30276	1	419
11999	4	95, 464	13378	5	582	15216	8	247	16012	5	447, 523				30277	8	419
12000	0	147	13379	2	582	15217	5	247	16013	2	447, 523	3			30279	2	401
12010	5	602	13380	8	150, 298	15331	8	420	16014	9	447, 523	30000	2	104	30280	8	401
12065	5	147	13381	5	150, 298	15332	5	420	16015	6	523	30001	9	104	30281	5	401
12100	0	147	13382	2	155	15334	9	420	16016	3	522, 523	30002	6	104	30282	2	401
12224	6	434	13385	3	155	15335	6	420	16017	0	523	30003	3	104	30283	9	401
12225	3	434	13622	9	155	15336	3	420	17000	1	369	30010	1	53	30285	3	401
12232	1	48, 434	13965	7	108	15337	0	420	17001	8	369	30011	8	53	30286	0	401
12233	8	433	13966	4	31	15351	6	607	17002	5	369	30013	2	53	30299	0	403
12235	2	434	13987	9	29, 108	15400	1	226	17003	2	377	30014	9	53	30310	2	419
12236	9	433	13990	9	28	15401	8	226	17004	9	377	30015	6	52	30328	7	473
12243	7	441	13995	4	29	15402	5	226	17005	6	377	30016	3	52	30329	4	37
12244	4	441	14000	4	15	15403	2	226	17006	3	379	30017	0	52	30331	7	37
12245	1	432	14001	1	15, 16	15404	9	226	17007	0	381	30018	7	52	30332	4	473
12249	9	432, 433	14002	8	15, 16	15416	2	226	17008	7	369	30019	4	52	30333	1	486
12250	5	88, 436	14003	5	15	15417	9	226	17009	4	369	30020	0	101	30334	8	62, 605
12265	9	53, 55, 56, 440	14004	2	15, 16, 17	15418	6	226	17010	0	369	30021	7	101	30335	5	60, 417
12266	6	53, 56, 440	14005	9	15, 16	15419	3	226	17011	7	369	30024	8	53	30336	2	63, 241, 417
12272	7	23, 89, 438	14006	6	15	15420	9	226	17020	9	386, 387	30045	3	585	30337	9	63, 413
12275	8	23, 89, 438	14007	3	15	15421	6	226	17021	6	386, 387	30046	0	584	30338	6	63, 605
12276	5	23, 89, 438	14008	0	15	15424	7	224	17022	3	386, 387	30047	7	584	30339	3	62
12285	7	439	14009	7	15	15425	4	224	17024	7	386, 387	30048	4	584	30340	9	405
12287	1	139, 447	14010	3	19	15449	0	225	17025	4	21, 129, 371	30049	1	584	30341	6	405
12291	8	428, 429, 439	14011	0	19	15450	6	225	17026	1	21, 129, 371	30057	6	584	30345	4	405
12292	5	439	14012	7	19	15451	3	225	17027	8	21, 129, 371	30058	3	585	30346	1	405
12294	9	439	14013	4	22	15452	0	225	17028	5	371	30059	0	585	30347	8	405
12295	6	23, 88, 89, 424, 426, 427, 428, 429, 431, 436, 438, 439	14014	1	22	15453	7	225	17029	2	371	30061	3	585	30348	5	405
12296	3	427, 439	14015	8	20, 116, 119	15454	4	225	17030	8	371	30062	0	585	30350	8	405
12299	4	439	14016	5	20, 116, 119	15455	1	225	17035	3	375	30063	7	585	30351	5	405
12300	7	432	14017	6	21, 128	15456	8	225	17036	0	375	30066	8	579	30355	3	404
12310	6	441	14019	2	19	15457	5	225	17037	7	375	30068	2	579	30356	0	173, 294, 404
12315	1	446	14020	2	19	15458	2	225	17038	4	375	30071	2	579	30360	7	405
12316	8	446	14021	9	16	15459	5	225	17039	1	375	30072	9	585	30361	4	405
12322	9	430	14022	6	17	15460	5	225	17045	2	367	30108	5	328, 539	30370	6	405
12323	6	430	14023	3	21, 129	15461	2	224	17050	6	363	30110	8	328, 539	30371	3	405
12324	3	428, 431	14025	7	20, 116, 119	15462	9	224	17051	3	363	30111	5	152, 300, 536	30380	5	406
12325	0	431	14030	1	18, 26, 384	15467	4	224	17052	0	361	30112	2	152, 300, 536	30385	0	406
12329	8	86, 87, 437	14031	8	18	15473	5	226	17053	7	361	30113	9	152, 300, 536	30390	4	406
12330	4	86, 87, 437	14032	5	18	15474	2	226	17060	5	365	30114	6	153, 537	30395	9	406
12335	9	86, 87, 437	14033	2	18	15475	9	226	17070	4	373	30115	3	152, 300, 536	30396	6	406
12336	6	86, 87, 437	14034	9	18	15477	3	226	17071	1	373	30116	0	152, 300, 301, 536	30410	9	412
12337	3	86, 87, 437	14035	6	18	15485	8	226	17072	8	373	30117	7	152, 300, 301, 536	30411	6	412
12338	0	86, 87, 437	14036	3	16	15504	6	225	17073	5	373	30118	4	153, 536	30412	3	413
12339	7	23, 86, 87, 89, 437, 438	14037	0	16	15505	3	225	17074	2	373	30119	1	153, 536	30413	0	413
12342	7	86, 87, 437	14038	7	17	15506	0	23, 50, 89, 225, 438	17075	9	373	3018	4	153, 536	30414	7	412
12343	4	86, 87, 437	14039	4	17	15513	8	100, 226	17090	2	25, 26, 383, 384	30108	5	328, 539	30415	4	412
12350	2	432	14040	0	17	15514	5	100, 226	17091	9	26, 27, 384, 385	30110	8	328, 539	30416	1	412
12352	6	425	14041	7	16	15620	3	67	17092	6	26, 27, 384, 385	30111	5	152, 300, 536	30417	8	412
12353	3	425	14042	4	16	15621	0	67, 606	17099	2	25, 26, 383, 384	30112	2	152, 300, 536	30418	5	412
12354	0	425	14050	9	23, 89, 438	15622	7	67, 606	17099	6	26, 27, 384, 385	30113	9	152, 300, 536	30418	5	412
12360	1	434	14060	8	22, 167, 301	15623	4	67	17099	3	26, 27, 384, 385	30133	7	151, 298, 538	30420	8	408
12366	3	425, 428	14061	5	22, 167, 301	15920	4	323	17099	3	26, 27, 384, 385	30134	4	151, 298	30421	5	408
12396	0	429	14090	5	20, 90, 321	15921	1	322	17094	0	26, 27, 384, 385	30148	1	152, 537, 605	30422	2	408
12397	7	425, 429	14091	2	20, 90, 321	15922	8	322	17100	8	359	30149	8	152, 537, 605	30423	9	408
12398	4	429	14092	9	17, 90	15925	9	322	17101	5	359	30200	6	418	30424	6	408
12399	1	429	14940	3	32, 33	15926	6	322	17102	2	359	30206	8	416	30425	3	410
12403	5	428, 431	14941	0	32	16000	2	522	17110	7	357	30207	5	416	30426	0	410
12404	2	427	14953	3	35	16001	9	522	17111	4	357	30208	2	416	30427	7	410
12484	4	427	14954	0	35	16002	6	522	17112	1	357	30209	9	64, 407, 416	30428	4	410
			14956	4	35	16003	3	447, 523	17922	6	33	30210	5	418	30429	1	410
			14965	6	108	16004	0	447, 523	18121	2	605	30211	2	64, 407, 413, 416	30430	7	414
			14966	3	31	16005	7	447, 523	18380	3	603	30220	4	418	30431	4	414
			14970	0	35	16006	4	523				30230	3	418	30435	2	414
			14980	9	28										30436	9	414

30437	6	414	33302	4	58, 100	36115	7	470, 472, 473	40226	3	395	40460	1	306	40581	3	314
30438	3	414	33303	1	59, 100	36116	4	472	40227	0	394	40461	8	305, 306	40582	0	314
30439	0	414	33304	8	58, 59, 100	36117	1	470, 472	40228	7	395	40462	5	305, 306	40583	7	314
30440	6	404	33305	5	73, 100	36118	8	472	40229	4	394	40463	2	306	40600	1	272
30441	3	404	33306	2	98	36120	1	474	40230	0	395	40464	9	306	40601	8	143, 167, 272
30450	5	404	33307	9	98	36121	8	474	40240	9	395	40470	0	305	40602	5	272
30451	2	404	35065	6	440	36125	6	283, 482	40242	3	110, 395	40472	4	305	40603	2	143, 272
30452	9	411	35343	5	440	36126	3	482	40243	0	110, 394	40474	8	305	40604	9	276
30453	6	411	35711	2	328	36127	0	283, 482	40244	7	395	40476	2	305	40605	6	273
30454	3	411	35720	4	327	36128	7	481	40245	4	394	40478	6	305	40606	3	273
30455	0	411	35730	3	327	36129	4	480	40246	1	395	40480	9	305	40607	0	273
30470	3	409	35734	1	327	36130	0	134, 475	40247	8	394	40482	3	309	40610	0	272
30471	0	409	35912	3	328	36131	7	105, 478	40249	2	394	40485	4	307	40611	7	272
30472	7	409	36003	7	490	36140	9	56, 77, 481	40260	7	395	40486	1	341, 534	40612	4	272
30473	4	409	36004	4	490	36150	8	478	40262	1	395	40487	8	341, 535	40613	1	272
30480	2	65, 403, 407	36006	8	488	36233	8	327	40263	8	395	40490	8	341, 534	40616	2	273
30500	7	54	36010	5	494	36323	6	327	40264	5	395	40494	6	341, 534	40617	9	273
30501	4	54	36011	2	494	38202	2	148	40270	6	395	40498	4	534	40618	6	273
30502	1	54	36013	6	489				40272	0	395	40499	1	534	40620	9	272
30503	8	55	36015	0	489	4			40274	4	395	40501	1	319	40621	6	272
30504	5	55	36016	7	489	40007	8	353, 399	40276	8	395	40503	5	319	40622	3	272
30505	2	54	36017	4	490	40009	2	353, 399	40290	4	34, 111, 394	40504	2	173, 294, 318	40623	0	272
30506	9	54	36020	4	471	40010	8	353, 399	40291	1	34, 111, 394	40505	9	318	40624	7	272
30507	6	55	36021	1	471	40011	5	353, 399	40292	8	34, 394	40506	6	340, 534	40625	4	143, 272, 273
30508	3	55	36025	9	471	40012	2	353, 399	40293	5	34, 37, 394	40507	3	319	40626	1	272
30509	0	55	36026	6	470	40013	9	353, 399	40294	2	34, 397	40509	7	340, 534	40627	8	272
30510	6	55	36028	0	301, 470, 472, 473	40019	5	150	40295	9	34, 397	40510	3	341, 535	40628	5	272
33206	5	64	36030	3	480	40130	3	353, 399	40296	6	393	40511	0	307	40629	2	272
33207	2	64	36032	7	483	40131	0	353, 399	40297	3	393	40512	7	307, 501	40630	8	276
33208	9	60	36033	4	488	40132	7	396	40299	7	403	40516	5	321, 513, 533	40631	5	276
33209	6	60, 608	36034	1	483	40135	8	396	40310	9	304	40517	2	321, 513, 533	40632	2	284
33211	9	61	36037	2	488	40137	2	396	40311	6	304	40535	6	311	40636	0	284
33212	6	61	36038	9	480	40139	6	396	40312	3	304	40536	3	311	40638	4	284
33214	0	61	36044	0	476	40140	2	396	40313	0	304	40538	7	313	40642	1	271
33215	7	61	36045	7	476	40144	0	66, 396	40320	8	304	40539	4	313	40643	8	271
33216	4	61	36046	4	476	40148	8	396	40330	7	309	40540	0	316	40644	5	271
33217	1	61	36048	8	477	40149	5	397	40331	4	309	40541	7	316	40645	2	284
33220	1	61, 608	36052	5	477	40150	1	397, 398	40333	8	309	40543	1	317	40646	9	284
33232	4	66	36053	2	477	40152	5	396	40340	6	400	40544	8	318	40647	6	284
33238	6	61	36054	9	477	40153	2	397	40341	3	400	40545	5	318	40654	4	274
33246	1	114, 289	36055	6	471	40159	4	396	40342	0	400	40546	2	311	40655	1	151, 274, 298, 538
33248	5	61	36056	3	483	40179	2	399	40343	7	400	40547	9	311	40656	8	151, 274, 298, 538
33249	2	99	36057	0	477	40182	2	399	40344	4	400	40549	3	315	40657	5	274
33250	8	99	36062	4	483	40185	3	276	40345	1	400	40550	9	315	40658	2	274
33251	5	99	36063	1	483	40186	0	271	40410	6	303	40551	6	315	40659	9	274
33252	2	99	36066	2	471	40187	7	271	40411	3	303	40552	3	315	40660	5	271
33255	3	101	36068	6	473	40188	4	271	40412	0	303	40553	0	75, 316	40661	2	285
33256	0	101	36069	3	473	40190	7	419	40414	4	308	40554	7	75, 316	40662	9	285
33260	7	99	36074	7	481	40191	4	396	40415	1	304	40555	4	173, 292, 308, 311	40663	6	285
33261	4	99	36075	4	486	40192	1	396	40416	8	312	40556	1	173, 292, 294, 308, 311	40664	3	285
33262	1	99	36087	7	477	40193	8	396	40417	5	312	40557	8	313	40665	0	285
33269	0	99, 165	36090	7	105, 479	40194	5	396	40418	2	312	40558	5	313	40666	7	285
33270	6	99, 119, 165	36095	2	135, 475	40195	2	396	40435	9	302	40561	5	317	40667	4	285, 322
33271	3	99, 165	36096	9	135, 475	40196	9	396	40436	6	302	40562	2	317	40668	1	285, 322
33272	0	99	36099	0	73, 479	40198	3	398	40437	3	302	40563	9	317	40669	8	285
33273	7	99	36100	3	135, 475	40204	1	326	40438	0	302	40570	7	310	40670	4	143, 151, 173, 274, 298, 538
33280	5	101	36101	0	135, 475	40205	8	326	40439	7	302	40571	4	310	40676	6	95, 277, 464
33281	2	101	36102	7	487	40206	5	326	40440	3	304	40572	1	310	40680	3	277
33282	9	100, 235, 299	36103	4	487	40207	2	327	40441	0	304	40573	8	310	40681	0	277
33288	1	49	36104	1	479	40208	9	326	40442	7	302	40574	5	310	40685	8	174, 276, 293
33292	8	162, 606	36105	8	479	40212	6	402	40445	8	307	40575	2	310	40686	5	174, 276, 292
33293	5	162, 606	36106	5	135, 474	40214	0	402	40446	5	307	40576	9	310	40690	2	275
33294	2	162, 164, 606	36107	2	135, 474	40216	4	402	40450	2	304	40577	6	310	40691	9	275
33295	9	162, 164, 606	36108	9	135, 474	40220	1	395	40453	3	309	40578	3	312	40692	6	275
33296	6	162, 606	36109	6	135, 474	40222	5	395	40454	0	309	40579	0	312	40693	3	275
33297	3	162, 164, 606	36111	9	135, 474	40223	2	394	40455	7	306	40580	6	314	40694	0	275
33300	0	58	36112	6	135, 474	40224	9	395	40457	1	306						
33301	7	59				40225	6	394	40458	8	306						

40695	7	275	50603	9	392	60536	7	337	71529	5	342	75923	7	554	81104	1	449
40700	8	282	50605	3	392	60540	4	334	71531	8	344	75924	4	554	81106	5	449
40701	5	282	50606	0	392	60541	1	334	73502	6	588	75925	1	554	81108	9	449
40702	2	282	50607	7	60,392	60542	8	333	73505	7	588	75926	8	554	81109	6	449
40703	9	282	50608	4	392	60551	0	336	73506	4	588	75927	5	554	81116	4	441
40704	6	282	50612	1	392	60552	7	336	73507	1	588,589	75930	5	290	81117	1	452
40705	3	282	50620	6	393	60580	0	330	73508	8	588	77315	8	595	81118	8	452
40706	0	283	50621	3	393	60581	7	330	73509	5	588	77338	7	578	81191	1	451
40707	7	283	50622	0	393	60582	4	330	73510	1	588	79000	1	176	81195	9	451
40708	4	283	50623	7	393	60583	1	331	73511	8	588	79001	8	176	81198	0	457
40709	1	283	50624	4	393	60584	8	331	73513	2	588	79002	5	176	81199	7	457
40710	7	273,283	50625	1	393	60585	5	331	73515	6	589	79003	2	176	81200	0	449
40711	4	273,283	50626	8	393	60586	2	331	73750	1	591	79004	9	176,609	81201	7	449
40720	6	279	50627	5	393	61190	0	150	74201	7	577	79005	6	176,609	81202	4	449
40721	3	279	50630	5	392	61280	8	150	74731	9	579	79006	3	179,459	81204	8	449
40722	0	279,283	50631	2	392	61400	0	150	74750	0	535	79007	0	179,459	81206	2	449
40723	7	279,283	50644	2	402	65060	2	329	75600	7	567	79008	7	176	81208	6	449
40724	4	278	50702	9	391	66900	0	467	75800	1	566	79009	4	176	81209	3	449
40725	1	278	50707	4	391	66901	7	467	75801	8	563	79010	0	178	81292	5	451
40726	8	278,283	50710	4	390	66902	4	467	75803	2	567	79011	7	178	81295	6	451
40727	5	278,283	50712	8	390	66904	8	597	75804	9	567	79012	4	178	81296	3	457
40728	2	279	50722	7	391	66905	5	526	75805	6	491	79013	1	178	81300	7	449
40729	9	166,278,297	50800	2	392	66906	2	526	75806	3	566	79014	8	177	81301	4	449
40730	5	270	50801	9	392	66907	9	527	75807	0	563	79015	5	177	81302	1	449
40731	2	270	50802	6	392	66908	6	527	75808	7	569	79016	2	177	81304	5	449
40732	9	270	50803	3	392	66909	3	527	75809	4	569	79017	9	177	81306	9	449
40733	6	270	50805	7	392	66911	6	520	75810	0	563	79018	6	177	81308	3	449
40734	3	270	50806	4	392	66912	3	520	75820	9	491,569	79019	3	177	81391	5	451
40735	0	270	50807	1	50,392	66913	0	520	75821	6	491,569	79020	9	177	81395	3	451
40736	7	270	50808	8	392	66915	4	520	75822	3	563	79021	6	177	81400	4	449
40737	4	270	50815	6	392	66916	1	520	75824	7	563	79022	3	176	81401	1	449
40738	1	270	50817	0	392	66917	8	520	75825	4	562	79023	0	176	81402	8	449
40740	4	271	50823	1	392	66940	6	446,519	75830	8	562	79024	7	177	81404	2	449
40741	1	271	50905	4	390	7			75831	5	562	79025	4	177	81406	6	449
40742	8	271	50908	5	390	71001	6	567,595	75832	2	562	79026	1	177	81408	0	449
40770	1	57,415	50910	8	390	71002	3	567,595	75840	7	564	79027	8	177	81492	9	451
40771	8	57,415	50913	9	390	71003	0	567,595	75841	4	564	79028	5	177	81495	0	451
40772	5	57,415	50915	3	390	71004	7	567,595	75842	1	564	79029	2	177	81502	5	449
40773	2	57,415	50918	4	390	71005	4	567,595	75843	8	564	79030	8	179,459	81504	9	449
40774	9	57,415				71006	1	567,595	75844	5	564	79031	5	179,459	81506	3	449
40775	6	57,415	6			71400	7	539,596	75850	6	562	79032	2	179,459	81591	9	451
40776	3	57,415	60002	7	335	71421	2	597,611	75851	3	562	79033	9	179,459	81595	7	451
40780	0	268	60012	6	336	71430	4	495,597	75852	0	562	79034	6	179,459	81602	2	449
40781	7	268	60014	0	334	71431	1	495,597	75853	7	491,562	79035	3	179,459	81604	6	449
40782	4	268	60015	7	336	71433	5	539,596	75854	4	491,562	79036	0	179,459	81606	0	449
40783	1	269	60019	5	336	71441	0	402,461	75855	1	491,562	79037	7	179,459	81608	4	449
40784	8	269	60037	9	332	71460	1	347	75860	5	568	79038	4	178	81611	4	450,529
40785	5	269	60038	6	332	71461	8	347	75861	2	568	79039	1	178	81692	3	451
40786	2	269	60040	9	333	71470	0	348	75862	9	568	79040	7	178	81695	4	451
40790	9	281	60041	6	335	71471	7	348	75863	6	568	79041	4	178	81700	5	449
40791	6	281	60042	3	333	71477	7	348	75864	3	568	79042	1	175	81701	2	449
40792	3	281	60044	7	337	71490	8	18,37,79, 135,170,344, 348,475	75865	0	568	79044	5	175	81702	9	449
40793	0	281	60045	4	337	71492	2	345	75866	7	568	79046	9	175	81704	3	449
40794	7	281	60046	1	337	71493	9	345	75867	4	568	79553	2	66	81706	7	449
40795	4	281	60270	0	150	71494	6	345	75868	1	568	8			81707	4	449
40800	5	355	60310	3	150	71495	3	343	75869	8	568	80023	6	452	81791	3	451
40801	2	355	60503	9	332	71496	3	343	75870	4	80,566	80024	3	452	81795	1	451
40802	9	355	60508	4	333	71510	3	347	75900	8	555	80025	0	452	81796	8	457
5			60510	7	333	71512	7	347	75902	2	555	80026	7	452	81800	2	449
50002	0	66	60511	4	333	71513	4	347	75903	9	555	80027	4	452	81801	9	449
50205	5	391	60512	1	334	71516	5	347	75904	6	555	80028	1	452	81802	6	449
50210	9	391	60521	3	335	71520	2	344	75906	0	555	80029	8	452	81804	0	449
50305	2	391	60522	0	334	71521	9	342	75907	7	555	81000	6	449	81806	4	449
50400	4	391	60524	4	335	71522	6	342	75908	4	555	81095	2	449	81850	7	450
50600	8	392	60525	1	335	71523	3	342	75912	1	555	81100	3	449	81891	0	451
50601	5	392	60526	8	336	71527	1	342	75920	6	554	81101	0	449	81895	8	451
50602	2	392	60527	5	335	71528	8	342	75921	3	554	81102	7	449	81901	6	450
			60530	5	334				75922	0	554				81902	3	450

81903	0	450	82116	3	453	82330	3	289	83500	9	48, 245	83799	7	250	83962	5	251
81904	7	450	82117	0	453	82331	0	289	83514	6	245	83801	7	259, 465	83971	7	240
81905	4	450	82118	7	453	82338	9	289	83592	4	244	83803	1	259, 465	83980	9	240
81906	1	450	82119	4	453	82345	7	287, 288	83597	9	244	83828	4	262, 263	83981	6	241
81907	8	450	82120	0	453	82346	4	287, 288, 289	83600	6	176, 246, 609	83830	7	263	83992	2	241
81908	5	450	82122	4	453	82347	1	287, 288, 289	83601	3	176, 233, 246, 609	83842	0	261	83994	6	241
81909	2	450	82123	1	453	82350	1	174, 288, 293	83610	5	548	83843	7	261	84018	8	258, 280
81910	8	450	82128	6	453	82352	5	287	83611	2	548	83848	2	264, 323	84020	1	259
81911	5	450	82129	3	453	82354	9	288	83612	9	548	83849	9	264, 323	84021	8	259
81996	2	452	82130	9	453	82355	6	33, 457	83613	6	548	83851	2	264, 323	84035	5	259
81997	9	452	82132	3	453	82356	3	33, 457	83615	0	70	83867	3	77	84040	9	253
81998	6	452	82134	7	453	82357	0	33, 457	83616	7	548	83868	0	77	84041	6	253
81999	3	452	82136	1	453	82359	4	174, 288, 293	83648	8	261	83869	7	245, 252	84042	3	253
82001	2	265, 455, 458	82137	8	453	82360	0	289	83649	5	261	83878	9	262	84043	0	253
82003	6	455	82138	5	453	82362	4	289	83696	9	254	83879	6	262	84045	4	161, 541
82004	3	455	82140	8	453	82370	9	288	83697	6	254	83880	2	115, 254	84046	1	33, 247
82005	0	455	82142	2	453	82371	6	288	83698	3	254	83881	9	254	84047	8	33, 35, 247
82006	7	455	82150	7	453	82394	5	288	83699	0	254	83884	0	164, 245, 606	84048	5	33, 247
82007	4	455	82151	4	453	82395	2	288	83700	3	254	83887	1	260	84100	0	214
82008	1	455	82159	0	453	82419	5	466, 581	83701	0	254	83888	8	260	84101	7	214
82009	8	455	82200	9	456	82420	1	466, 581	83702	7	45, 254	83889	5	260	84103	1	216
82010	4	455	82210	8	428, 431	82440	9	466, 590	83703	4	45, 254	83890	1	163, 164, 252, 606	84104	8	216
82011	1	455	82211	5	87, 437	82441	6	466, 590	83704	1	254	83891	8	163, 164, 252, 606	84105	5	216
82012	8	455	82212	2	87, 437	82442	3	466, 590	83705	8	254	83892	5	163, 252	84106	2	216
82013	5	265, 455, 458	82215	3	428, 431	83310	4	77	83712	6	210	83893	2	163, 252	84107	9	215
82014	2	455	82250	4	80	83311	1	77	83716	4	211	83897	0	259, 465	84108	6	215
82016	6	455	82251	1	80, 566	83401	9	244	83718	8	212	83900	7	248	84109	3	215
82017	3	455	82252	8	80	83402	6	244	83720	1	212	83901	4	248	84110	9	215
82018	0	455	82253	5	80	83403	3	142, 244	83721	8	211	83902	1	248	84111	6	215
82019	7	265, 455, 458	82255	9	79	83405	7	244	83722	5	212	83903	8	248	84112	3	215
82020	3	455	82256	6	79	83406	4	244	83723	2	211	83904	5	248	84113	0	215
82022	7	455	82257	3	79	83407	1	244	83724	9	212	83905	2	248	84115	4	215
82023	4	455	82265	8	79	83408	8	176, 245, 246, 609	83725	6	211	83906	9	248	84116	1	215
82028	9	455	82266	5	79	83409	5	176, 245, 246, 609	83726	3	212	83907	6	248	84117	8	216
82029	6	265, 455, 458	82267	2	79	83410	1	245	83727	0	211	83908	3	248	84118	5	216
82030	2	455	82268	9	78	83414	9	245	83728	7	212	83909	0	248	84119	2	216
82032	6	455	82269	6	78	83415	6	245	83730	0	212	83910	6	249	84125	3	220
82034	0	455	82270	2	456	83416	0	142, 244	83732	4	212	83911	3	249	84128	4	220, 260
82036	4	455	82271	9	456	83417	7	244	83735	5	211	83912	0	249, 262, 263	84130	7	221
82037	1	265, 455, 458	82272	6	456	83418	7	244	83739	3	211	83913	7	249, 263	84131	4	221
82038	8	455	82273	3	456	83419	4	245	83740	9	213	83914	4	249	84133	8	221
82040	1	455	82274	0	441, 456	83433	0	142, 244	83742	3	213	83915	1	249	84134	5	221
82042	5	455	82275	7	456	83434	7	244	83744	7	213	83916	8	249, 609	84135	2	221
82050	0	455	82276	4	456	83450	7	245	83748	5	110, 265, 458	83917	5	249, 609	84158	1	220, 260
82051	7	455	82277	1	456	83451	4	245	83749	2	110, 265, 458	83918	2	48, 249, 609	84161	1	230
82059	3	455	82278	8	456	83452	1	245	83750	8	265, 458	83919	9	249, 609	84170	3	230
82064	7	454	82279	5	456	83453	8	245	83751	5	265, 458	83921	2	249, 609	84171	0	230
82065	4	454	82280	1	456	83454	5	245	83752	2	265, 458	83922	9	249, 609	84172	7	230
82066	1	454	82281	8	456	83455	2	245	83753	9	110, 111, 265, 458	83923	6	249	84174	1	215
82068	5	454	82300	6	456	83466	8	245	83754	6	265, 458	83924	3	249	84177	2	164, 243, 606
82069	2	454	82301	3	456	83467	5	245	83755	3	265, 458	83925	0	249	84178	9	243
82070	8	454	82305	1	286	83468	2	176, 245, 246, 609	83756	0	265, 458	83926	7	249	84179	6	243
82072	2	454	82306	8	456	83469	9	176, 245, 246, 609	83757	7	110, 111, 265, 458	83929	8	210	84180	2	239
82073	9	454	82307	5	286, 288	83479	8	244	83758	4	265, 458	83932	8	212	84181	9	239
82074	6	454	82308	2	286, 288	83480	4	142, 244	83759	1	111, 265, 458	83933	5	212	84182	6	239
82076	0	454	82309	9	286, 288	83481	1	244	83777	5	255, 280	83935	9	212	84185	7	38, 239
82077	7	454	82310	5	114, 143, 174, 287, 288, 289, 292, 320	83482	8	244	83780	5	255, 280	83941	0	213	84186	4	38, 239
82078	4	454	82312	9	114, 143, 287, 288, 289	83486	6	261	83781	2	255, 276, 280	83946	5	213	84187	1	239
82081	4	454	82314	3	114, 143, 174, 287, 288, 289, 292, 320	83487	3	261	83782	9	255, 280	83947	2	213	84188	8	38, 239
82101	9	453	82316	7	62, 143, 288, 292	83488	0	548	83783	6	255, 280	83949	6	213	84189	5	38, 239
82104	0	453	82318	1	288	83489	7	548	83785	0	250	83955	7	240	84200	7	250
82106	4	453	82319	8	288	83490	3	244	83787	4	250	83956	4	240	84205	2	238
82108	8	453	82328	0	80, 108	83491	0	244	83788	1	98, 250	83957	1	240	84206	9	238
82110	1	453				83492	7	244	83789	8	250	83958	8	240	84207	6	238
82112	5	453				83498	9	247	83790	4	250	83960	1	251	84209	0	238
82113	2	453				83499	6	247	83798	0	255, 280	83961	8	251	84215	1	255
82114	9	453													84216	8	255
															84217	5	221, 258

84220	5	255	84472	8	256, 280	84675	3	209	84912	9	219	85083	5	193	85295	2	264, 323
84221	2	254	84490	2	231	84676	0	209	84920	4	236	85092	7	188	85296	9	264, 323
84230	4	251	84491	9	231	84677	7	209	84921	1	236	85093	4	188	85300	3	202
84231	1	251	84492	6	231	84678	4	209	84922	8	236	85097	2	187	85301	0	202
84239	7	241, 246	84509	1	194	84680	7	206	84923	5	236	85098	9	187	85302	7	202
84244	1	176, 241, 246, 609	84510	7	194	84681	4	206	84924	2	236	85099	6	63, 241, 605	85303	4	202
84245	8	176, 241, 246, 609	84511	4	194	84682	1	206	84925	9	236	85100	9	204	85304	1	202
84251	9	153, 537	84512	1	194	84683	8	206	84926	6	237	85101	6	204	85305	8	203
84253	3	153, 537	84514	5	194	84684	5	207	84927	3	236, 237	85103	0	204	85306	5	203
84257	1	242	84515	2	194	84685	2	207	84928	0	236, 237	85104	7	204	85307	2	203
84258	8	242	84517	6	194	84686	9	206	84929	7	236, 237	85105	4	204	85308	9	203
84259	5	242	84519	0	196	84687	6	207	84930	3	234	85107	8	204	85309	6	203
84295	3	255	84520	6	196	84688	3	207	84931	0	234, 237	85108	5	204	85310	2	203
84300	4	265, 458	84521	3	196	84689	0	207	84932	7	234	85109	2	98, 204	85311	9	203
84301	1	265, 458	84522	0	196	84690	6	207	84933	4	234, 237	85111	5	204	85312	6	203
84302	8	265, 458	84523	7	195	84691	3	207	84934	1	234	85120	7	204, 205	85320	1	197
84303	5	265, 458	84524	4	195	84692	0	207	84935	8	234, 237	85121	4	205	85321	8	197
84304	2	110, 265, 458	84525	1	195	84693	7	207	84936	5	233, 609	85124	5	205	85322	5	197
84305	9	110, 265, 458	84526	8	195	84694	4	207	84937	2	233, 609	85125	2	205	85323	2	197
84306	6	265, 458	84528	2	195	84729	3	216	84943	3	236, 237, 606	85128	3	205	85324	9	197
84307	3	265, 458	84529	9	195, 511	84730	9	216	84944	0	236, 237, 606	85129	0	205	85330	0	185
84308	0	265, 458	84530	5	195, 511	84731	6	214	84948	8	233	85132	0	205	85331	7	185
84309	7	265, 458	84555	8	232	84732	3	214	84950	1	231	85133	7	205	85332	4	185
84310	3	110, 265, 458	84556	5	232	84733	0	214	84951	8	231	85150	4	221	85333	1	185
84311	0	110, 265, 458	84558	9	233, 609	84750	7	256	84958	7	231	85151	1	221	85334	8	185
84329	5	217	84559	6	233, 609	84775	0	258	84959	4	231, 233	85200	6	200	85335	5	185
84331	8	217	84561	9	176, 233, 609	84776	7	258	84963	1	234, 609	85201	3	200	85336	2	184
84335	6	217	84562	6	176, 233, 609	84777	4	258	84965	5	233, 609	85202	0	200	85337	9	184
84337	0	217	84564	0	232	84778	1	258	84966	2	233, 609	85203	7	200	85338	6	184
84348	6	211	84565	7	232	84779	8	258	85021	7	198	85204	4	200	85400	0	190
84349	3	211	84567	1	222	84780	4	258	85024	8	198	85205	1	200	85401	7	190
84351	6	211	84568	8	222	84781	1	258	85025	5	198	85206	8	200	85402	4	190
84353	0	211	84569	5	223	84782	8	258	85026	2	198	85207	5	200	85403	1	190
84355	4	210	84570	1	223	84783	5	258	85027	9	198	85208	2	200	85404	8	190
84365	3	227	84571	8	223	84785	9	250	85028	6	198	85211	2	235	85405	5	190
84366	0	227	84572	5	223	84806	1	201	85029	3	199	85225	9	71, 538	85406	2	190
84377	6	227	84573	2	223	84807	8	201	85030	9	199	85230	3	100, 235, 299	85407	9	191
84378	3	227	84574	9	223	84808	5	201	85036	1	199	85231	0	100, 235, 299	85408	6	191
84379	0	227	84575	6	222	84815	3	201	85037	8	199	85232	7	119	85409	3	191
84380	6	227	84576	3	222	84816	0	201	85038	5	199	85233	4	119	85410	9	191
84381	3	227	84577	0	223	84819	1	201	85040	8	253	85240	2	256, 279	85411	6	192
84400	1	229	84578	7	223	84820	7	228	85041	5	253	85241	9	256, 279	85412	3	192
84401	8	229	84579	4	223	84821	4	228	85042	2	253	85242	6	256, 279	85413	0	192
84402	5	229	84580	0	223	84824	5	229	85043	9	253	85243	3	256, 279	85414	7	191
84403	2	229	84581	7	223	84825	2	228	85055	2	199	85244	0	256, 279	85415	4	191
84404	9	229	84582	4	223	84826	9	228	85056	9	199	85250	1	253	85416	1	192
84424	7	245	84583	1	232	84827	6	228	85057	6	199	85251	8	253	85417	8	192
84425	4	245	84584	8	232	84828	3	228	85060	6	188	85252	5	253	85418	5	192
84426	1	245	84586	2	232	84829	0	228	85061	3	187	85260	0	176, 246, 609	85419	2	192
84427	8	245	84587	9	232	84830	6	229	85062	0	188	85261	7	176, 246, 609	85500	7	182
84434	6	243	84589	3	232	84831	3	229	85063	7	186	85266	2	176, 246, 609	85501	4	182
84444	5	257	84590	9	232	84835	1	229	85064	4	186	85267	9	176, 246, 609	85502	1	182
84445	2	257	84592	3	233	84836	8	98, 229	85065	1	186	85270	9	189	85503	8	182
84446	9	257	84593	0	233	84837	5	229	85066	8	186	85271	6	189	85504	5	182
84448	3	257	84605	0	234, 609	84860	3	77	85067	5	48, 186	85272	3	189	85505	2	182
84449	0	257	84606	7	234, 609	84863	4	77	85068	2	48, 186	85273	0	189	85506	9	182
84450	6	257	84607	4	234	84900	6	218	85069	9	187	85274	7	188	85507	6	183
84452	0	257	84608	1	234	84901	3	218	85070	5	187	85275	4	186	85508	3	183
84454	4	257	84609	8	234	84902	0	218	85071	2	188	85276	1	189	85509	0	183
84455	1	262	84610	4	234	84903	7	218	85072	9	188	85277	8	189	85510	6	183
84456	8	257	84611	1	234	84904	4	218	85073	6	186	85278	5	189	85511	3	183
84458	2	257	84612	8	234	84905	1	219	85074	3	187	85279	2	189	87027	7	193, 593
84460	5	261	84613	5	234	84906	8	219	85075	0	187	85280	8	186	88080	1	589
84462	9	250	84614	2	234	84907	5	219	85076	7	188	85281	5	186	88081	8	589
84470	4	256, 280	84671	5	208	84908	2	60, 219	85077	4	188	85282	2	189	88090	0	591
84471	1	256, 280	84672	2	208	84909	9	219	85080	4	62, 193, 292	85283	9	187	88099	3	577
			84673	9	208	84910	5	219	85081	1	62, 193, 292	85290	7	230	88256	0	588
			84674	6	209	84911	2	219	85082	8	193	85291	4	230	88271	3	581

88285	0	457	88939	2	575	93204	3	492, 512	93362	0	498
88287	4	597	88940	8	575	93211	1	494	93364	4	513
88288	1	597	88941	5	575	93212	8	494	93365	1	513
88300	0	82, 442	88942	2	575	93214	2	495	93366	8	494
88301	7	82, 442	88946	0	575	93220	3	489	93367	5	506
88302	4	83, 443	88947	7	575	93225	8	587	93371	2	512
88303	1	83, 85, 443, 445	88948	4	576	93226	5	587	93372	9	512
88304	8	83, 443	88949	1	573, 591	93250	0	587	93373	6	512
88305	5	83, 85, 443, 445	88950	7	576, 582	93251	7	587	93374	3	512
88306	2	84, 444	88951	4	576, 582	93252	4	587	93375	0	509
88307	9	84, 444	88990	3	68	93253	1	587	93377	4	485
88308	6	84, 85, 444, 445	9			93254	8	587	93383	5	505
88309	3	84, 444	90902	1	42	93255	5	587	93384	2	505
88310	9	85, 445	93034	6	500	93256	2	587	93385	9	505
88311	6	85, 445	93091	9	134, 486	93257	9	587	93386	6	505
88312	3	82, 85, 442, 445	93101	5	500	93258	6	587	93390	3	505
88313	0	83, 443	93102	2	504	93259	3	586	93391	0	505
88314	7	83, 443	93105	3	134, 486	93260	9	586	93392	7	505
88315	4	84, 85, 444, 445	93110	7	504	93261	6	586	93393	4	505
88316	1	84, 444	93111	4	504	93280	7	581	93394	1	505
88317	8	85, 445	93112	1	497	93281	4	581	93395	8	505
88320	8	85, 445	93116	9	497	93290	6	115, 581	93398	9	513
88598	1	594	93120	6	497	93300	2	499	93399	6	513
88608	7	559	93121	3	497	93301	9	485	93400	9	513
88609	4	594	93122	0	485	93302	6	485	98120	1	48
88627	8	594	93125	1	485	93303	3	503			
88628	5	594	93129	9	500	93306	4	502			
88636	0	594	93134	3	500	93307	1	502			
88637	7	560	93138	1	492, 493	93310	1	507			
88640	7	559	93139	8	492	93311	8	506			
88642	1	559	93140	4	493	93312	5	499			
88643	8	566	93141	1	500	93313	2	499			
88644	5	566	93144	2	501	93318	7	502, 578			
88645	2	566	93145	9	501	93321	7	95, 464			
88717	6	578	93146	6	501	93322	4	507			
88810	4	570	93147	3	501	93323	1	506			
88811	1	570	93148	0	501	93324	8	496			
88823	4	570	93148	0	501	93325	5	493			
88826	5	571	93153	4	500	93326	2	494			
88827	2	571	93154	1	587	93327	9	511			
88829	6	573, 591	93155	8	586	93328	6	511			
88834	0	572	93156	5	586	93329	3	511			
88836	4	571	93157	2	586	93330	9	470			
88839	5	573	93160	2	504	93331	6	508			
88840	1	573	93161	9	504	93332	3	508			
88843	2	502, 572	93163	3	587	93333	0	508			
88846	3	502, 572	93164	0	496	93334	7	509			
88850	0	571	93165	7	496	93335	4	509			
88853	1	572	93166	4	503	93336	1	510			
88855	5	596	93167	1	503	93337	8	510			
88900	2	596	93168	8	503	93338	5	510			
88901	9	596	93169	5	503	93345	3	151, 507			
88902	6	596	93170	1	484	93346	0	506			
88903	3	595	93171	8	502	93347	7	499			
88911	8	596	93173	2	503	93348	4	499			
88912	5	596	93174	9	503	93349	1	499			
88928	6	574	93175	6	503	93350	7	493			
88929	3	576	93176	3	502	93351	4	496			
88930	9	576, 590	93179	4	492	93352	1	496			
88932	3	574	93180	0	498	93353	8	496			
88933	0	574	93181	7	498	93354	5	496			
88935	4	574	93182	4	498	93355	2	496			
88937	8	574	93189	3	495	93356	9	497			
88938	5	574	93191	6	490	93357	6	497			
			93192	3	490	93358	3	498			
			93200	5	489	93359	0	308, 501			
			93201	2	493	93360	6	498			
			93203	6	492	93361	3	498			



DE Impressum

Herausgeber: Assheuer + Pott GmbH & Co. KG, Talweg 11, 59846 Sundern, Tel. +49 2933 97350, info@aps-germany.de, www.aps-germany.de

Gestaltung: Assheuer + Pott GmbH & Co. KG - Druck: Fromm + Rasch GmbH & Co. KG, Breiter Gang 10-16, 49074 Osnabrück

Wir behalten uns das Recht vor, die angegebenen Spezifikationen jederzeit zu ändern. Irrtum, Druckfehler und technische Änderungen vorbehalten. Artikelbeschreibungen sowie Abbildungen und Fotodarstellungen sind ohne Gewähr. Alle Angebote ohne Dekoration. Alle Preise verstehen sich unverbindlich (UVP) in Euro zuzüglich der gesetzlichen Mehrwertsteuer.

© 2025 - Die Vervielfältigung dieses Kataloges - auch wenn partial - muss ausschließlich von der Assheuer + Pott GmbH & Co. KG genehmigt werden.

Bildnachweis: Niklas Thiemann Fotodesign · Stoll GmbH – Studio für Fotografie · ZENITH Werbung & Fotografie GmbH & Co. KG · iStock · Envato Elements Pty Ltd. ·

Media Impression GmbH · MPB-Schnücker · track by track GmbH · stock.adobe.com · CASA-Fotoatelier für Werbung GmbH & Co. KG

EN Imprint

Editor: Assheuer + Pott GmbH & Co. KG, Talweg 11, 59846 Sundern, Germany, Tel. +49 2933 97350, info@aps-germany.de, www.aps-germany.de

Design: Assheuer + Pott GmbH & Co. KG - Print: Fromm + Rasch GmbH & Co. KG, Breiter Gang 10-16, 49074 Osnabrück, Germany

We reserve the right to alter at any time the specifications stated without notice. Errors, printing error and technical changes reserved. Item description as well as images and illustrations are without guaranty. All offers are without decoration. All prices are without commitment (RRP) in Euro and exclude the legal VAT prescribed by law.

© 2025 - This catalogue may not be reproduced in whole or in part unless specific prior written authorization of Assheuer + Pott GmbH & Co. KG.

Picture credits: Niklas Thiemann Fotodesign · Stoll GmbH – Studio für Fotografie · ZENITH Werbung & Fotografie GmbH & Co. KG · iStock · Envato Elements Pty Ltd. ·

Media Impression GmbH · MPB-Schnücker · track by track GmbH · stock.adobe.com · CASA-Fotoatelier für Werbung GmbH & Co. KG



no. 3800



buffet | tabletop | bar

Assheuer + Pott GmbH & Co. KG
Talweg 11, 59846 Sundern / Germany

[aps-germany.de](https://www.aps-germany.de)

CATALOGUE no. 51

