



DEGRENE
PARIS

Since 1948



2024

Plus de 75 ans après sa création, la Maison DEGRENNE, fabricant français d'arts de la table premium, est toujours une entreprise familiale gérée par la famille SPRUCH.

Les 4 frères de la famille : Antoine, Marc-Alain, Benjamin et Thomas, s'engagent tous les jours pour développer et réinventer cette Maison française.

La Maison DEGRENNE perpétue, transmet et revisite les savoir-faire de ses artisans dans ses trois Manufactures : à Vire en Normandie pour les couverts et la platerie, en acier inoxydable et en métal argenté, à Limoges pour la porcelaine fine extra blanche et en Hongrie pour la porcelaine de couleur.

Dans ses Manufactures, DEGRENNE associe le meilleur des deux mondes : l'artisanat et l'industrie, en réinventant des gestes artisanaux et en les adaptant à un process industriel de moyennes séries.

Les savoir-faire des artisans orfèvres et porcelainiers des Manufactures DEGRENNE sont reconnus et sélectionnés par les plus exigeants : les plus beaux hôtels et restaurants, de Paris à New-York City en passant par Séoul, les Maisons de Luxe les plus prestigieuses, les grandes compagnies aériennes.

La famille SPRUCH et toutes les équipes de la Maison DEGRENNE sont fiers de vous accompagner et de vous proposer dans ce catalogue ses collections de couverts, platerie, vaisselle et verrerie, qui marient qualité, intemporalité, design et usage. Ses collections DEGRENNE, toutes au service des Chefs, sont pensées et réalisées pour vous inspirer et pour mettre en valeur vos plus belles créations.

More than 75 years after its creation, the DEGRENNE House, a French manufacturer of premium tableware, remains a family-run business managed by the SPRUCH family.

The four brothers of the family : Antoine, Marc-Alain, Benjamin and Thomas commit themselves every day to developing and reinventing this French Maison.

DEGRENNE perpetuates, transmits, and revisits the expertise of its craftsmen in its three Manufactures: in Vire, Normandy, for cutlery and silverware in stainless steel and silver-plated metal in Limoges for extra-white fine porcelain and in Hungary for colored porcelain.

In its Manufactures, DEGRENNE combines the best of both worlds : craftsmanship and industry, reinventing artisanal gestures and adapting them to a medium-scale industrial process.

The know-how of the goldsmiths and porcelain makers in the DEGRENNE Manufactures is recognized and selected by the most demanding clientele : the finest hotels and restaurants from Paris to New York City to Seoul, as well as the most prestigious Luxury Houses and major airlines.

The SPRUCH family and all the teams at DEGRENNE are proud to accompany and present in this catalog their collections of cutlery, silverware, tableware, and glassware, which blend quality, timelessness, design, and functionality. DEGRENNE collections, all at the service of chefs, are designed and created to inspire you and showcase your most beautiful creations.

PARTENAIRES
D'
EXCELLENCE
PARTNERS OF EXCELLENCE





L S N O U S

F O N T

C O N F I A N C E

THEY TRUST US

LE FOUQUET'S
SOCIETE DES BAINS DE MER
LUTETIA
WALDORF ASTORIA
PENINSULA
PLAZA
ELEVEN MADISON PARK
BELLAGIO
MARRIOTT / STARWOOD /
SHERATON
FOUR SEASONS
HILTON WORLDWIDE
FAIRMONT / RAFFLES HOTELS
SWISSOTEL
W HOTELS

ACCOR HOTELS
PULLMAN
SOFITEL / BARRIÈRE
M GALLERY / MAMA SHELTER
NOVOTEL
MERCURE
IBIS

INTERCONTINENTAL
RITZ CARLTON

LOUVRE HOTELS
GOLDEN TULIP
CAMPANILE
KYRIAD

LA VAISSELLE/DINNERWARE

ARTY CREATION	40-41
BAHIA	52-57
BLUE SHADES	42-43
BORÉAL	36-37
BORÉAL SATIN	38-39
BRUME	58-59
COCOTTES	48-51
ÉCLIPSE	30-31
GALON OR	26-27
GALON PLATINE	24-25
GRAPHIQUE CLASSIQUE	34-35
L	16-19
L COUTURE	10-11
L FRAGMENT	12-13
L PERLES DE ROSÉE	14-15
MODULO	44-47
MODULO NATURE	60-63
REMINISCENCE	28-29
SD ONE	20-21
SD ONE OR	20-21
SUPERNATURE	22-23
SUPERNATURE OR	22-23

LA CAFÉTERIE/TEATIME

API	78
EMPILÉO CAFÉTERIE	72-73
GRAPHIQUE CLASSIQUE	78
L	76
L COUTURE	76
L FRAGMENT	76
L PERLES DE ROSÉE	76
MODULO NATURE	80
NEWPORT	78
SALAM	64-69
SALAM MONOCHROME	70-71
SALAM THÉ	74-75
SD ONE	76

LE COUVERT/FLATWARE

CLASSIQUE	
ABSOLU	128-129
BLOIS	144-147
BLOIS CONTRASTE	148-149
CONFIDENCE	269
COUTEAUX STEAK	154-155
FLORENCIA	160
LAGUIOLE	132-133
LUTÈCE	269
LE PHIL	142-143
MARQUISE	161
MIKADO MIROIR	150-151
MIKADO VINTAGE	152-153
MILADY	136-137
MIRAGE	158
MIRAGE LES ESSENCES	158
NEUILLY	138-139
NORMANDY	130-131
PETIT GOURMET	268-270
PIÈCES COMPLÉMENTAIRES	162-163
VERLAINE	164-165
VIEUX PARIS SATINÉ	156-157

DESIGN

AQUATIC MIROIR	108-109
ASTRÉE CISELÉ	120-121
COUTURE	110-111
FUSE MIROIR	104-105
FUSE MARTELÉ	106-107
GUEST CUIVRE	100-101
GUEST MIROIR	96-97
GUEST STAR	98-99
GUEST VINTAGE	102-103
L'EMPREINTE	86-87
L'E STARCK®	94-95
MIRAGE	122-123
NORWAY	124-125
ONDE MIROIR	116-117
ONDE GOLD	118-119
OVATION	114-115
SOLSTICE	92-93
SUPERNATURE	112-113
XY MIROIR	88-89
XY BLACK MIROIR	90-91

LA PLATERIE/HOLLOWARE

NEWPORT ACCESSOIRES	178
NEWPORT BAR	176
NEWPORT CAFÉTERIE	174
NEWPORT PLATEAUX CUBIQUE	171
NEWPORT PLATEAUX MIROIR	170
NEWPORT SERVICE À TABLE	172
NORMANDY	170

LE VERRE/GLASSWARE

ALLURE	182-183
ANYTIME	186-187
CARAFES - DÉCANTEURS	198-199
DOMAINE	184-185
EMPILÉO	192-193
HYPNOTIC JAUGÉ	187
GALATÉE	184-185
MONTMARTRE	186-187
MONTMARTRE JAUGÉ	187
MUSE	182-183
NEWPORT TWIST	188-191

GOBELETS/GLASSES

ALLEGRO	196-197
ALLURE	183
COSMOPOLITAIN	194
DOLCE	195
LOOP	194
INSTANT	195
MAMBO	197
MUSE	183
NEWPORT TWIST	191
ROC	195

LE BUFFET EVENTO

ACCESSOIRES	220-221
CHAFING DISHES	204-207
DISTRIBUTEURS À CÉRÉALES	213
MODULES FROIDS	208-211
PIÈCES DÉTACHÉES	224-225
PLAN	222-223
PLANCHES LES ESSENCES	218-219
SUPPORTS À FIL RECTANGULAIRES	214-216
SUPPORTS À FIL RONDS	216-217
URNES À JUS DE FRUITS	212



VITAL	228-229
GLORIA	230-231
UNISSET	232-233
AMAZONE	234-235
CASSIOPEE	236-237
UNI	238-243



C
O L L E C T I O N S
R A N G E S





A
V A I S S E L L E
DINNERWARE

DEGRENNÉ travaille les formes et les matières en portant une attention particulière aux attentes des chefs, tant esthétiques que dans l'usage. Pour faire de la table un moment dédié aux plaisirs gastronomiques, du plus simple au plus élaboré, DEGRENNÉ imagine des collections uniques qui incarnent l'excellence et qui peuvent être associées entre elles. En jouant sur les combinaisons, les contrastes, les formes, les couleurs et les matières, chaque met trouve harmonieusement sa place à table, avec élégance et sobriété. Matières nobles, lignes épurées, épousez tous les savoir-faire DEGRENNÉ lorsque vous dressez votre table.

DEGRENNÉ develops shapes and materials, while paying careful attention to chefs' practical usage and aesthetic requirements. DEGRENNÉ designs unique collections that are the very embodiment of excellence and can also be combined, in order to make dining a moment of culinary pleasure, from the simplest to the most elaborate pleasures. Each dish harmoniously finds its rightful place on the table, with simplicity and elegance, thanks to the combinations, contrasts, shapes, colours and materials employed by DEGRENNÉ. Capitalize on DEGRENNÉ's extensive expertise when setting your table : we offer sleek lines and the finest materials.





PORCELAINE DE LIMOGES ET EXCELLENCE

LIMOGES PORCELAIN AND EXCELLENCE

Alliez élégance et sobriété grâce à des matières nobles et des formes aux lignes épurées. D'une blancheur et d'une opalescence remarquables, la Porcelaine de Limoges est symbole d'excellence et de pureté.

Combine elegance and simplicity by harnessing the finest materials and sleek lines. Stunning white and milkily iridescent Limoges porcelain is the epitome of excellence and purity.



Découvrez les coulisses de notre manufacture à Limoges
Discover our factory in Limoges



BLANC
WHITE



IVOIRE
IVORY



ASSIETTE PLATE 237398
ROUND DINNER PLATE
W/WIDE RIM

EXT : 32 CM - 12 IN^{5/8}
INT : 19,5 CM - 7 IN^{11/16}

237399
EXT : 28 CM - 11 IN
INT : 17 CM - 6 IN^{11/16}

237400
EXT : 24 CM - 9 IN^{7/16}
INT : 15 CM - 5 IN^{7/8}

239328
EXT : 32 CM - 12 IN^{5/8}
INT : 19,5 CM - 7 IN^{11/16}

239326
EXT : 28 CM - 11 IN
INT : 17 CM - 6 IN^{11/16}

239327
EXT : 24 CM - 9 IN^{7/16}
INT : 15 CM - 5 IN^{7/8}



Compatible avec les assiettes cocottes
Compatible with the casserole plates
P 50-51 ●●●●●



CLOCHE VERRE BOROSILICATE
DOME GLASS
COVER **204043**
17X9 CM
6 IN^{11/16} X 3 IN^{9/16}

BOUCHON PORCELAINE
PORCELAIN LID
206504
5,2 CM - 2 IN^{1/16}



ASSIETTE GOURMET 237402
ROUND SHALLOW BOWL
W/WIDE RIM

EXT : 30 CM - 11 IN^{13/16}
INT : 14 CM - 5 IN^{1/2}

237403
EXT : 28 CM - 11 IN
INT : 11,5 CM - 4 IN^{1/2}



239311
EXT : 30 CM - 11 IN^{13/16}
INT : 14 CM - 5 IN^{1/2}

239330
EXT : 28 CM - 11 IN
INT : 11,5 CM - 4 IN^{1/2}



Compatible avec les bols cocottes
Compatible with the round casseroles
P 50-51 ●●●●●



CLOCHE INOX
DOME STAINLESS STEEL
COVER **182614**
24 CM - Ø 9 IN^{7/16}

182301
14,8 CM - Ø 5 IN^{13/16}



ASSIETTE À PAIN 237401
ROUND BREAD & BUTTER PLATE
W/WIDE RIM

EXT : 14 CM - 5 IN^{1/2}
INT : 9,5 CM - 3 IN^{3/4}



239329
EXT : 14 CM - 5 IN^{1/2}
INT : 9,5 CM - 3 IN^{3/4}



TASSE ESPRESSO 227828
10 CL - 3 OZ^{3/8}
DEMITASSE CUP 5,7 CM - 2 IN^{1/4}

SOUCOUPE ESPRESSO 237404
12,6 CM
DEMITASSE SAUCER Ø 4 IN^{15/16}



TASSE LUNGO 227829
25 CL - 8 OZ^{2/16}
COFFEE/TEA CUP 8,5 CM - 3 IN^{3/8}

SOUCOUPE LUNGO 237405
15,8 CM - Ø 6 IN^{1/4}
COFFEE/TEA SAUCER



L COUTURE

Finedining

Haute Porcelaine de Limoges

High Limoges Porcelain

MADE IN FRANCE



BLANC
WHITE



ASSIETTE PLATE 227843

ROUND EXT : 32 CM - 12 IN^{5/8}
DINNER PLATE INT : 19,5 CM - 7 IN^{11/16}
W/WIDE RIM

227844

EXT : 28 CM - 11 IN
INT : 17 CM - 6 IN^{11/16}

227845

EXT : 24 CM - 9 IN^{7/16}
INT : 15 CM - 5 IN^{7/8}

NEW
NOIR
BLACK



245599

EXT : 32 CM - 12 IN^{5/8}
INT : 19,5 CM - 7 IN^{11/16}

245601

EXT : 28 CM - 11 IN
INT : 17 CM - 6 IN^{11/16}

245603

EXT : 24 CM - 9 IN^{7/16}
INT : 15 CM - 5 IN^{7/8}



Compatible avec les assiettes cocottes
Compatible with the casserole plates

P 50-51 ●●●●●



CLOCHE VERRE BOROSILICATE

DOME GLASS

COVER **204043**

17X9 CM

6 IN^{11/16} X 3 IN^{9/16}

BOUCHON PORCELAINE

PORCELAIN LID

206504

5,2 CM - 2 IN^{1/16}



ASSIETTE 227847

GOURMET EXT : 30 CM - 11 IN^{13/16}

ROUND INT : 14 CM - 5 IN^{1/2}

SHALLOW BOWL

W/WIDE RIM

227848

EXT : 28 CM - 11 IN
INT : 11,5 CM - 4 IN^{1/2}



245607

EXT : 30 CM - 11 IN^{13/16}

INT : 14 CM - 5 IN^{1/2}

Compatible avec les bols cocottes

Compatible with the round casseroles

P 50-51 ●●●●●

Compatible avec les assiettes cocottes

Compatible with the casserole plates

P 50-51 ●●●●●



CLOCHE INOX

DOME STAINLESS STEEL

COVER **182614**

24 CM - Ø 9 IN^{7/16}

182301

14,8 CM - Ø 5 IN^{13/16}



ASSIETTE À PAIN 227846

ROUND BREAD EXT : 14 CM - 5 IN^{1/2}

& BUTTER PLATE INT : 9,5 CM - 3 IN^{3/4}

W/WIDE RIM



TASSE 227828

ESPRESSO 10 CL - 3 OZ^{3/8}

DEMITASSE CUP 5,7 CM - 2 IN^{1/4}

SOUCOUPE 227849

ESPRESSO 12,6 CM

DEMITASSE Ø 4 IN^{15/16}

SAUCER



TASSE 227829

LUNGO 25 CL - 8 OZ^{7/16}

COFFEE/TEA 8,5 CM - 3 IN^{3/8}

CUP

227849

SOUCOUPE 15,8 CM - Ø 6 IN^{1/4}

LUNGO

COFFEE/TEA

SAUCER



L FRAGMENT

Finedining

Haute Porcelaine de Limoges
High Limoges Porcelain

MADE IN FRANCE



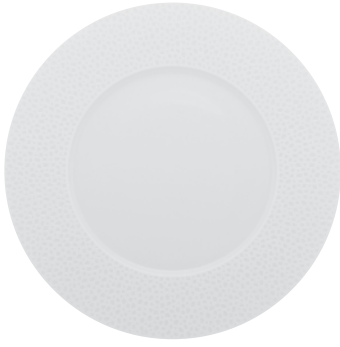

ASSIETTE PLATE 233922
 ROUND EXT : 32 CM - 12 IN^{5/8}
 DINNER PLATE INT : 19,5 CM - 7 IN^{11/16}
 W/WIDE RIM

233923
 EXT : 28 CM - 11 IN
 INT : 17 CM - 6 IN^{11/16}

233924
 EXT : 24 CM - 9 IN^{7/16}
 INT : 15 CM - 5 IN^{7/8}



Compatible avec les assiettes cocottes
 Compatible with the casserole plates
 P 50-51 ●●●●●



CLOCHE VERRE BOROSILICATE
 DOME GLASS
 COVER **204043**
 17X9 CM
 6 IN^{11/16} X 3 IN^{9/16}

BOUCHON PORCELAINE
 PORCELAIN LID
206504
 5,2 CM - 2 IN^{1/16}



ASSIETTE 233926
GOURMET EXT : 30 CM - 11 IN^{13/16}
 ROUND INT : 14 CM - 5 IN^{1/2}
 SHALLOW BOWL
 W/WIDE RIM

233927
 EXT : 28 CM - 11 IN
 INT : 11,5 CM - 4 IN^{1/2}



Compatible avec les bols cocottes
 Compatible with the round casseroles
 P 50-51 ●●●●●

Compatible avec les assiettes cocottes
 Compatible with the casserole plates
 P 50-51 ●●●●●



CLOCHE INOX
 DOME STAINLESS STEEL
 COVER **182614**
 24 CM - Ø 9 IN^{7/16}

182301
 14,8 CM - Ø 5 IN^{13/16}



ASSIETTE À PAIN 233925
 ROUND BREAD EXT : 14 CM - 5 IN^{1/2}
 & BUTTER PLATE INT : 9,5 CM - 3 IN^{3/4}
 W/WIDE RIM



TASSE 227828
ESPRESSO 10 CL - 3 OZ^{3/8}
 DEMITASSE CUP 5,7 CM - 2 IN^{1/4}

SOUCOUPE 233928
ESPRESSO 12,6 CM
 DEMITASSE Ø 4 IN^{15/16}
 SAUCER



TASSE 227829
LUNGO 25 CL - 8 OZ^{7/16}
 COFFEE/TEA 8,5 CM - 3 IN^{3/8}
 CUP

233929
SOUCOUPE 15,8 CM - Ø 6 IN^{1/4}
LUNGO
 COFFEE/TEA
 SAUCER



L PERLES DE ROSÉE

Finedining
Haute Porcelaine de Limoges
High Limoges Porcelain

MADE IN FRANCE





ASSIETTE PLATE 227822
 ROUND EXT : 32 CM - 12 IN^{5/8}
 DINNER PLATE INT : 19,5 CM - 7 IN^{11/16}
 W/WIDE RIM

227823
 EXT : 28 CM - 11 IN
 INT : 17 CM - 6 IN^{11/16}

227824
 EXT : 24 CM - 9 IN^{7/16}
 INT : 15 CM - 5 IN^{7/8}



Compatible avec les assiettes cocottes
 Compatible with the casserole plates
 P 50-51 ●●●●●



CLOCHE VERRE BOROSILICATE
 DOME GLASS
 COVER **204043**
 17X9 CM
 6 IN^{11/16} X 3 IN^{9/16}

BOUCHON PORCELAINE
 PORCELAIN LID
206504
 5,2 CM - 2 IN^{1/16}



ASSIETTE 227826
GOURMET EXT : 30 CM - 11 IN^{13/16}
 ROUND INT : 14 CM - 5 IN^{1/2}
 SHALLOW BOWL
 W/WIDE RIM

227827
 EXT : 28 CM - 11 IN
 INT : 11,5 CM - 4 IN^{1/2}



Compatible avec les bols cocottes
 Compatible with the round casseroles
 P 50-51 ●●●●●

Compatible avec les assiettes cocottes
 Compatible with the casserole plates
 P 50-51 ●●●●●



CLOCHE INOX
 DOME STAINLESS STEEL
 COVER **182614**
 24 CM - Ø 9 IN^{7/16}

182301
 14,8 CM - Ø 5 IN^{13/16}



ASSIETTE À PAIN 227825
 ROUND BREAD EXT : 14 CM - 5 IN^{1/2}
 & BUTTER PLATE INT : 9,5 CM - 3 IN^{3/4}
 W/WIDE RIM



TASSE 227828
ESPRESSO 10 CL - 3 OZ^{3/8}
 DEMITASSE CUP 5,7 CM - 2 IN^{1/4}

SOUCOUPE 227831
ESPRESSO 12,6 CM
 DEMITASSE Ø 4 IN^{15/16}
 SAUCER



TASSE 227829
LUNGO 25 CL - 8 OZ^{7/16}
 COFFEE/TEA CUP 8,5 CM - 3 IN^{3/8}

SOUCOUPE
LUNGO 227832
 COFFEE/TEA 15,8 CM - Ø 6 IN^{1/4}
 SAUCER



L

Finedining
Haute Porcelaine de Limoges
High Limoges Porcelain





ASSIETTE CREUSE 232576
CALOTTE EXT : 18,5 CM - 7 IN^{5/16}
 ROUND
 CEREAL PLATE



PLAT À TARTE 227839
 PIE/PIZZA 31,5 CM
 PLATE, 12 IN^{13/32}
 FLAT



PLAT ROND 227840
CREUX 30,5 CM
 ROUND 12 IN^{1/64}
 DEEP DISH



PLAT OVALE 227837
 OVAL DISH 36,5 X 26,5 CM
 14 IN^{3/8} X 10 IN^{7/16}

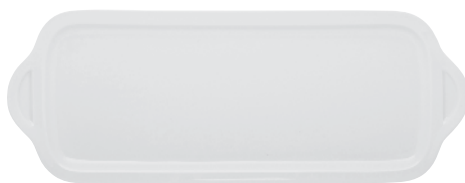

PLAT À CAKE 227838
RECTANGULAIRE 35 X 15 CM
 RECTANGULAR 13 IN^{25/32} X 5 IN^{1/16}
 DISH CAKE



SALADIER 227841
 SALAD BOWL 25 CM - 9 IN^{13/16}

NEW



VERSEUSE 245885
 SAUCE JUG 13 CM - 4 IN^{3/8}



COUPELLE 227842
 SMALL BOWL 13,5 CM - 5 IN^{5/16}



THÉIÈRE 227834
 TEA POT 1L - 33 OZ^{13/16}
 H 15,7 CM Ø 12,4 CM
 H 6 IN^{3/16} Ø 4 IN^{7/8}



SUCRIER 227836
 SUGAR BOWL 30 CL - 10 OZ^{1/8}
 H 10,8 CM - Ø 9,2 CM
 H 4 IN^{1/4} - Ø 3 IN^{5/8}



CRÉMIER 227835
 CREAM JUG 16 CL - 5 OZ^{7/16}
 H 8,5 CM Ø 6,7 CM
 H 3 IN^{3/8} Ø 2 IN^{5/8}



L

Finedining

Haute Porcelaine de Limoges
High Limoges Porcelain

MADE IN FRANCE



SD ONE BLANC
WHITE



ASSIETTE PLATE 241052
ROUND DINNER PLATE 32 CM - 12 IN^{5/8}
W/WIDE RIM

241050
27 CM - 10 IN^{5/8}

241051
21,5 CM - 8 IN^{7/16}

242916
14 CM - 5 IN^{1/2}

SD ONE OR
GOLD



242547
32 CM - 12 IN^{5/8}

241053
27 CM - 10 IN^{5/8}

241054
21,5 CM - 8 IN^{7/16}



ASSIETTE COUPE 241048
SHALLOW COUPE 25 CM - 9 IN^{13/16}
BOWL, LARGE

241049
SHALLOW COUPE 19 CM - 7 IN^{1/2}
BOWL, MEDIUM



BOL 241143
BOWL 14 CM - 5 IN^{1/2}
55 CL - 18 OZ^{5/8}



TASSE ESPRESSO 242910
ESPRESSO CUP H 6,3 CM - 2 IN^{1/2}
Ø 6 CM - 2 IN^{3/8}
7 CL - 2 OZ^{3/8}



TASSE THÉ/CAFÉ 242912
TEA/COFFEE CUP H 8 CM - 3 IN^{1/8}
Ø 7,8 CM - 3 IN^{1/16}
15 CL - 5 OZ^{1/16}

SOUCOUPE 242914
SAUCER Ø 14 CM - 5 IN^{1/2}

SD ONE

Finedining
Haute Porcelaine de Limoges
High Limoges Porcelain

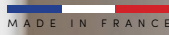

SUPERNATURE



ASSIETTE PLATE 242906
ROUND DINNER PLATE 32 CM - 12 IN^{5/8}

242330
27 CM - 10 IN^{5/8}

242331
21,5 CM - 8 IN^{7/16}

SUPERNATURE OR



ASSIETTE PLATE 244121
ROUND DINNER PLATE 27 CM - 10 IN^{5/8}



ASSIETTE À PAIN 242907
ROUND BREAD PLATE 14 CM - 5 IN^{1/2}



ASSIETTE DESSERT 244120
ROUND DESSERT PLATE 21,5 CM - 8 IN^{7/16}

Compatible avec l'assiette coupe
de la collection SD ONE
Compatible with the plates
of SD ONE collection



ASSIETTE COUPE 241048
SHALLOW COUPE 25 CM - 9 IN^{13/16}
BOWL, LARGE

SHALLOW COUPE 241049
BOWL, MEDIUM 19 CM - 7 IN^{1/2}

SUPERNATURE

Finedining
Haute Porcelaine de Limoges
High Limoges Porcelain

MADE IN FRANCE



GALON PLATINE
PLATINIUM



ASSIETTE PLATE 190054
ROUND DINNER PLATE 32 CM - 12 IN^{5/8}

190050
26,5 CM - 10 IN^{5/8}

190051
21,5 CM - 8 IN^{7/16}



PLAT OVALE 190069
OVAL DISH 36,5 X 26,5 CM - 14 IN^{3/8} X 10 IN^{7/16}



PLAT ROND PLAT 190068
ROUND CAKE/
PIE DISH 31,5 CM - 12 IN^{3/8}



ASSIETTE CREUSE 190052
CALOTTE RONDE 19 CM - 7 IN^{1/2}
ROUND
CEREAL PLATE



SALADIER 190071
SALAD BOWL 26 CM - 10 IN^{1/4}



ASSIETTE CREUSE 190053
À AILE RONDE 22,5 CM - 8 IN^{7/8}
ROUND
CEREAL PLATE



COUPELLE 190070
ROUND 13,5 CM - 5 IN^{5/16}
SMALL BOWL



TASSE À CAFÉ 203238
COFFEE CUP 10 CL - 3 OZ^{3/8}



TASSE À THÉ 203240
COFFEE/TEA CUP 20 CL - 6 OZ^{3/4}



TASSE DÉJEUNER 203242
BREAKFAST CUP 40 CL - 13 OZ^{1/2}

SOUCOUBE À CAFÉ 203239
COFFEE SAUCER 12,5 CM - Ø 4 IN^{15/16}

SOUCOUBE À THÉ 203241
COFFEE/TEA SAUCER 15 CM - Ø 5 IN^{7/8}

SOUCOUBE DÉJEUNER 203243
BREAKFAST SAUCER 19 CM - 7 IN^{1/2}



THÉIÈRE 203245
COFFEE/TEA POT 1 L - 33 OZ^{13/16}



SUCRIER 203250
SUGAR BOWL 15 CL - 5 OZ^{1/16}



GALON PLATINE

Finedining
Haute Porcelaine de Limoges
High Limoges Porcelain

MADE IN FRANCE

GALON OR
GOLD



ASSIETTE PLATE 241089
ROUND DINNER PLATE 32 CM - 12 IN^{5/8}

241090
26,5 CM - 10 IN^{5/8}

241091
21,5 CM - 8 IN^{7/16}



PLAT OVALE 241095
OVAL DISH 36,5 X 26,5 CM - 14 IN^{3/8} X 10 IN^{7/16}



PLAT ROND PLAT 241096
ROUND CAKE/
PIE DISH 31,5 CM - 12 IN^{3/8}



ASSIETTE À PAIN 227886
ROUND BREAD PLATE 14 CM - 5 IN^{1/2}
NEW



ASSIETTE CREUSE 241092
CALOTTE RONDE 19 CM - 7 IN^{1/2}
ROUND
CEREAL PLATE



SALADIER 241098
SALAD BOWL 26 CM - 10 IN^{1/4}



ASSIETTE CREUSE 241097
À AILE RONDE 22,5 CM - 8 IN^{7/8}
ROUND
CEREAL PLATE



COUPELLE 241099
ROUND 13,5 CM - 5 IN^{5/16}
SMALL BOWL



TASSE À CAFÉ 241093
COFFEE CUP 10 CL - 3 OZ^{3/8}



TASSE À THÉ 241104
COFFEE/TEA CUP 20 CL - 6 OZ^{3/4}



TASSE DÉJEUNER 241102
BREAKFAST CUP 40 CL - 13 OZ^{1/2}

SOUCOUPE À CAFÉ 241094
COFFEE SAUCER 12,5 CM - Ø 4 IN^{15/16}

SOUCOUPE À THÉ 241105
COFFEE/TEA SAUCER 15 CM - Ø 5 IN^{7/8}

SOUCOUPE DÉJEUNER 241103
BREAKFAST SAUCER 19 CM - 7 IN^{1/2}



THÉIÈRE 241100
COFFEE/TEA POT 1 L - 33 OZ^{13/16}



SUCRIER 241101
SUGAR BOWL 15 CL - 5 OZ^{1/16}



GALON OR

Finedining
Haute Porcelaine de Limoges
High Limoges Porcelain





ASSIETTE PLATE 244638
ROUND DINNER PLATE 26 CM - 10 IN^{1/4}

244636
21,5 CM - 8 IN^{7/16}



ASSIETTE COUPE 244640
RONDE 19 CM - 7 IN^{1/2}
ROUND COUPE PLATE



REMINISCENCE

Finedining
Haute Porcelaine de Limoges
High Limoges Porcelain

MADE IN FRANCE





ASSIETTE PLATE 234605
DINNER PLATE EXT : 32 CM - 12 IN^{5/8}
INT : 19 CM - 7 IN^{1/2}

234612
EXT : 30 CM - 11 IN^{13/16}
INT : 18 CM - 7 IN^{1/16}

234607
EXT : 26,5 CM - 10 IN^{7/16}
INT : 17 CM - 6 IN^{11/16}

234608
EXT : 21,5 CM - 8 IN^{7/16}
INT : 13 CM - 5 IN^{1/8}

234611
EXT : 18,5 CM - 7 IN^{5/16}
INT : 11 CM - 4 IN^{5/16}

234603
EXT : 16 CM - 6 IN^{5/16}
INT : 10 CM - 3 IN^{15/16}



ASSIETTE CREUSE 234609
CALOTTE EXT : 19 CM - 7 IN^{1/2}
CEREAL PLATE INT : 12 CM - 4 IN^{3/4}

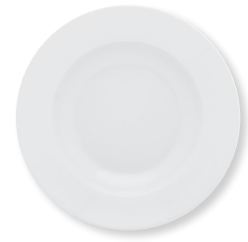

ASSIETTE CREUSE 234610
BORD À AILE EXT : 22,5 CM - 8 IN^{7/8}
ROUND DEEP PLATE INT : 13 CM - 5 IN^{1/8}



BOL À SALADE 234604
AVEC BORD À AILE 17,5 CM - 6 IN^{7/8}
SALAD BOWL WITH RIM



PLAT OVALE 234606
OVAL DISH 36,5 X 26,5 CM - 14 IN^{3/8} X 10 IN^{7/16}

ECLIPSE

Alldaydining

Porcelaine

Porcelain

MADE IN FRANCE







A
C É R A M I Q U E
CERAMIC

En porcelaine ou en grès, des iconiques COCOTTES BAHIA jusqu'à nos assiettes BLUE SHADES, nos collections de céramiques se déclinent en une multitude de formats et de couleurs et s'adaptent à vos besoins pour dresser vos tables du quotidien ou des grandes occasions.

In porcelain or stoneware, from the iconic COCOTTES BAHIA to our BLUE SHADES plates, our ceramic collections are available in a multitude of formats and colors and adapt to your needs to set your tables for everyday life or special occasions.

BLANC
WHITE



ASSIETTE PLATE 245447
 ROUND EXT : 32,5 CM - 12 IN^{13/16}
 DINNER PLATE INT : 20 CM - 7 IN^{7/8}
 W/WIDE RIM

245449
 EXT : 28,5 CM - 11 IN^{1/4}
 INT : 17 CM - 6 IN^{11/16}

245451
 EXT : 22,5 CM - 8 IN^{7/8}
 INT : 15 CM - 5 IN^{7/8}



Compatible avec les assiettes cocottes
 Compatible with the casserole plates

P 50-51 ●●●●●



CLOCHE VERRE BOROSILICATE
 DOME GLASS
 COVER **204043**
 17X9 CM
 6 IN^{11/16} X 3 IN^{9/16}

BOUCHON PORCELAINE
 PORCELAIN LID
206504
 5,2 CM - 2 IN^{1/16}



ASSIETTE GOURMET 245457
OVALE GRAND BASSIN EXT : 32 X 27 CM - 12 IN^{5/8} X 10 IN^{5/8}
 SHALLOW BOWL INT : 14,5 CM - 5 IN^{5/16}
 W/WIDE OVAL RIM 27 CL - 9 OZ^{1/8}



Compatible avec les bols cocottes
 Compatible with the round casseroles

P 50-51 ●●●●●



CLOCHE INOX
 DOME STAINLESS STEEL
 COVER **182614**
 24 CM - Ø 9 IN^{7/16}

ASSIETTE GOURMET 245455
OVALE PETIT BASSIN EXT : 30 X 26 CM - 11 IN^{13/16} X 10 IN^{1/4}
 SHALLOW BOWL INT : 13,5 CM - 5 IN^{5/16}
 W/WIDE OVAL RIM 17 CL - 5 OZ^{3/4}

Compatible avec les bols biseautés cocottes
 Compatible with the slanted rim bowls

P 50-51 ●●●●●

182301
 14,8 CM - Ø 5 IN^{13/16}



ASSIETTE 245741
À PÂTES/SOUBE EXT : 29,5 CM - 11 IN^{5/8}
 ROUND SOUP/PASTA INT : 17 CM - 6 IN^{11/16}
 BOWL W/WIDE RIM



ASSIETTE À PAIN 245453
 ROUND BREAD EXT : 15 CM - 9 IN^{1/8}
 & BUTTER PLATE INT : 9,5 CM - 3 IN^{3/4}
 W/WIDE RIM



GRAPHIQUE CLASSIQUE

Finedining

Porcelaine
Porcelain

MADE IN EUROPE

NEW





ASSIETTE PLATE 186770
RONDE 32,5 CM
 ROUND 12 IN^{13/16}
 DINNER PLATE
 W/WIDE RIM **186765**
 28 CM
 11 IN

186767
 22,5 CM
 8 IN^{7/8}



ASSIETTE PLATE 207134
OVALE EXT : 31 X 26,5 CM
 OVAL 12 IN^{3/16} X 10 IN^{7/16}
 DINNER PLATE INT : 18 CM - 7 IN^{1/16}
 W/WIDE RIM



ASSIETTE 207140
À PÂTES/SOUBE EXT : 29,5 CM - 11 IN^{5/8}
 ROUND SOUP/PASTA INT : 17 CM - 6 IN^{11/16}
 BOWL W/WIDE RIM



ASSIETTE CALOTTE 207136
OVALE EXT : 23,5 X 20 CM
 OVAL SHALLOW BOWL, INT : 9 IN^{1/4} X 7 IN^{7/8}
 COUPE



ASSIETTE À PAIN 187263
 ROUND 15 CM
 BREAD PLATE 5 IN^{7/8}
 W/WIDE RIM



ASSIETTE GOURMET 204040
OVALE GRAND BASSIN EXT : 32 X 27 CM - 12 IN^{5/8} X 10 IN^{5/8}
 SHALLOW BOWL INT : 14,5 CM - 5 IN^{5/16}
 W/WIDE OVAL RIM 27 CL - 9 OZ^{1/8}



Compatible avec les bols cocottes
 Compatible with the round casseroles
 P 50-51 ●●●●●



CLOCHE INOX
 DOME STAINLESS STEEL
 COVER **182614**
 24 CM - Ø 9 IN^{7/16}

ASSIETTE GOURMET 207138
OVALE PETIT BASSIN EXT : 30 X 26 CM - 11 IN^{13/16} X 10 IN^{1/4}
 SHALLOW BOWL INT : 13,5 CM - 5 IN^{5/16}
 W/WIDE OVAL RIM 17 CL - 5 OZ^{3/4}

Compatible avec les bols biseautés cocottes
 Compatible with the slanted rim bowls
 P 50-51 ●●●●●

182301
 14,8 CM - Ø 5 IN^{13/16}



ASSIETTE GOURMET 207141
OVALE BASSIN PLAT EXT : 30 X 26 CM - 11 IN^{13/16} X 10 IN^{1/4}
 OVAL PLATE W/WIDE INT : 12 CM - 4 IN^{3/4}
 + RIM, FLAT



Compatible avec les bols cocottes
 Compatible with the round casseroles
 P 50-51 ●●●●●



CLOCHE VERRE BOROSILICATE
 DOME GLASS
 COVER **204043**
 17X9 CM
 6 IN^{11/16} X 3 IN^{9/16}

BOUCHON PORCELAINE
 PORCELAIN LID
206504
 5,2 CM - 2 IN^{1/16}



BORÉAL

Finedining

Porcelaine

Porcelain

MADE IN EUROPE



BLANC
WHITE

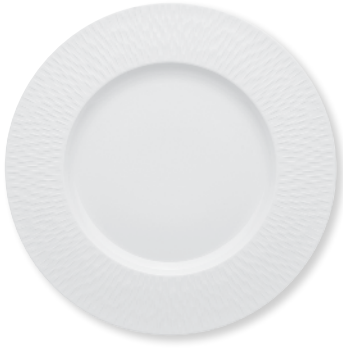

ASSIETTE PLATE 193319
DINNER PLATE EXT : 33 CM - 13 IN
W/WIDE RIM INT : 20 CM - 7 IN^{7/8}

193318
EXT : 28,5 CM - 11 IN^{1/4}
INT : 18,5 CM - 7 IN^{5/16}

193320
EXT : 22,5 CM - 8 IN^{7/8}
INT : 14,5 CM - 5 IN^{11/16}



ASSIETTE 223954
À PÂTES/SOUBE EXT : 29 CM - 11 IN^{7/16}
ROUND SOUP/PASTA INT : 16 CM - 6 IN^{5/16}
BOWL W/WIDE RIM



ASSIETTE GOURMET 207769
OVALE GRAND BASSIN EXT : 32 X 27 CM - 12 IN^{5/8} X 10 IN^{5/8}
SHALLOW BOWL INT : 14,5 CM - 5 IN^{5/16}
W/WIDE OVAL RIM 27 CL - 9 OZ^{1/8}

ASSIETTE GOURMET 193324
OVALE PETIT BASSIN EXT : 30 X 26 CM - 11 IN^{13/16} X 10 IN^{1/4}
SHALLOW BOWL INT : 13,5 CM - 5 IN^{5/16}
W/WIDE OVAL RIM 17 CL - 5 OZ^{3/4}



ASSIETTE À PAIN 202470
ROUND BREAD EXT : 15 CM - 5 IN^{7/8}
& BUTTER PLATE
W/WIDE RIM



Compatible avec les bols cocottes
Compatible with the round casseroles
P 50-51 ●●●●●

Compatible avec les bols biseautés cocottes
Compatible with the slanted rim bowls
P 50-51 ●●●●●



CLOCHE INOX
DOME STAINLESS STEEL
COVER **182614**
24 CM - Ø 9 IN^{7/16}

182301
14,8 CM - Ø 5 IN^{13/16}



CLOCHE VERRE BOROSILICATE
DOME GLASS
COVER **204043**
17X9 CM
6 IN^{11/16} X 3 IN^{9/16}

BOUCHON PORCELAINE
PORCELAIN LID
206504
5,2 CM - 2 IN^{1/16}



BORÉAL SATIN

Finedining

Porcelaine

Porcelain

MADE IN EUROPE



L'abus d'alcool est dangereux pour la santé
Alcohol abuse is dangerous for your health

BLANC
WHITE

NOIR
BLACK



SKYLINE

ASSIETTE PLATE
ROUND DINNER PLATE

239210
29 CM - 11 IN ^{7/16}

239214
29 CM - 11 IN ^{7/16}

240505
20 CM - 7 IN ^{7/8}

240509
20 CM - 7 IN ^{7/8}



CIRCLE

239211
29 CM - 11 IN ^{7/16}

239215
29 CM - 11 IN ^{7/16}

240506
20 CM - 7 IN ^{7/8}

240510
20 CM - 7 IN ^{7/8}



BRUSH

239209
29 CM - 11 IN ^{7/16}

239213
29 CM - 11 IN ^{7/16}

240504
20 CM - 7 IN ^{7/8}

240508
20 CM - 7 IN ^{7/8}

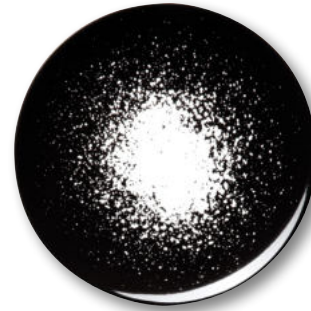

SPLASH

239208
29 CM - 11 IN ^{7/16}

239212
29 CM - 11 IN ^{7/16}

240503
20 CM - 7 IN ^{7/8}

240507
20 CM - 7 IN ^{7/8}



ARTY CREATION

Finedining

Porcelaine

Porcelain

MADE IN EUROPE



BLUE SHADES HALO
BLUE SHADES HALO



ASSIETTE PLATE 240242
ROUND DINNER PLATE EXT : 29 CM - 11 IN ⁷/₁₆

240243
EXT : 26 CM - 10 IN ¹/₄

240244
EXT : 23 CM - 9 IN ¹/₁₆

BLUE SHADES AQUARELLE
BLUE SHADES WATERCOLOR

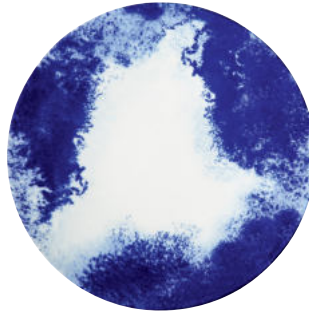

239661
EXT : 26 CM - 10 IN ¹/₄

239662
EXT : 23 CM - 9 IN ¹/₁₆



BOL COCOTTE 239658
+ ASSIETTE/COUVERCLE 14 CM - 5 IN ¹/₂ - 50 CL - 16 OZ ¹⁵/₁₆
ROUND CASSEROLE +**240245**
+ ROUND PLATE 12,5 CM - 4 IN ¹⁵/₁₆
CASSEROLE LID



BOL COCOTTE 239659
ROUND CASSEROLE 17,5 CM - 6 IN ⁷/₈
140 CL - 47 OZ ⁵/₁₆



BOL BISEAUTÉ COCOTTE 239660
SLANTED RIM BOWL 7,5 CM - 2 IN ¹⁵/₁₆
7 CL - 2 OZ ³/₈



BOL À DÉJEUNER 239657
BREAKFAST BOWL 14 CM - 5 IN ¹/₂
55 CL - 18 OZ ⁵/₈



BLUE SHADES

Finedining

Porcelaine

Porcelain

MADE IN EUROPE



ROND ROUND



ASSIETTE PLATE 207120
DINNER
COUPE PLATE
32 CM - 12 IN^{5/8}

207112
29 CM - 11 IN^{7/16}

207113
26 CM - 10 IN^{1/4}

207111
20 CM - 7 IN^{7/8}

207119
15 CM - 5 IN^{7/8}



ASSIETTE 207114
CREUSE/
CALOTTE
20 CM - 7 IN^{7/8}
ROUND
SHALLOW
BOWL



BOL 142722
DEEP
BOWL
28 CM - 11 IN
CONTENANCE : 2,5 L
CAPACITY : 84 OZ^{9/16}
H : 12 CM - 4 IN^{3/4}



GRIS PERLE
LIGHT GREY

230142
24 CM - 9 IN^{7/16}
CONTENANCE : 2 L
CAPACITY : 67 OZ^{5/8}
H : 11 CM - 4 IN^{1/4}



COUPE 136535
SHALLOW
BOWL,
FOOTED
24 CM - 9 IN^{7/16}
H : 11 CM - 4 IN^{1/4}

136530
8 CM - 3 IN^{1/8}
H : 2,5 CM - 1 IN

136529
24 CM - 9 IN^{7/16}
CONTENANCE : 2 L
CAPACITY : 67 OZ^{5/8}
H : 11 CM - 4 IN^{1/4}

230141
20 CM - 7 IN^{7/8}
CONTENANCE : 1,30 L
CAPACITY : 43 OZ^{15/16}
H : 9,5 CM - 3 IN^{3/4}

136511
20 CM - 7 IN^{7/8}
CONTENANCE : 1,30 L
CAPACITY : 43 OZ^{15/16}
H : 9,5 CM - 3 IN^{3/4}

230140
16 CM - 6 IN^{5/16}
CONTENANCE : 67 CL
CAPACITY : 22 OZ^{5/8}
H : 7,5 CM - 2 IN^{15/16}

136528
16 CM - 6 IN^{5/16}
CONTENANCE : 67 CL
CAPACITY : 22 OZ^{5/8}
H : 7,5 CM - 2 IN^{15/16}



230139
14 CM - 5 IN^{1/2}
CONTENANCE : 55 CL
CAPACITY : 18 OZ^{5/8}
H : 8 CM - 2 IN^{11/16}

154245
14 CM - 5 IN^{1/2}
CONTENANCE : 55 CL
CAPACITY : 18 OZ^{5/8}
H : 8 CM - 2 IN^{11/16}

136510
12 CM - 4 IN^{3/4}
CONTENANCE : 27 CL
CAPACITY : 9 OZ^{1/8}
H : 5,5 CM - 2 IN^{3/16}



136509
8 CM - 3 IN^{1/8}
CONTENANCE : 25 CL
CAPACITY : 9 OZ^{13/16}
H : 4,5 CM - 1 IN^{3/4}

ACCESSOIRES ACCESSORIES



PRÉSENTOIR 209382
À GÂTEAUX
ROUND
APP/PIZZA/
PRESENTATION
STAND
32 CM - 12 IN^{5/8}
H : 10,5 CM - 4 IN^{1/4}

209381
25 CM - 9 IN^{13/16}
H : 8,5 CM - 2 IN^{3/16}



CLOCHE 239771
EVENTO
VERRE
Ø 28 CM - 11 IN

239770
EVENTO
DOME
COVER
Ø 23 CM - 9 IN^{1/8}

239769
Ø 16 CM - 6 IN^{5/16}



PLAT À TARTE 136524
PIE/PIZZA
PLATE,
FLAT
32 CM - 12 IN^{5/8}



COFFRET 182915
SALIÈRE/
POIVRIÈRE
SALT & PEPPER
CRUET



MODULO

Finedining

Porcelaine

Porcelain

MADE IN EUROPE



CARRÉ SQUARE



ASSIETTE PLATE **207118**
SQUARE 28 CM - 11 IN
COUPE PLATE

207115
24 CM - 9 IN^{7/16}

207117
20 CM - 7 IN^{7/8}

207123
14 CM - 5 IN^{1/2}



COUPE **136502**
SQUARE BOWL,
FOOTED COUPE 12 CM - 4 IN^{3/4}
H : 3,5 CM - 1 IN^{3/8}

136503
8 CM - 3 IN^{1/8}
H : 2,5 CM - 1 IN

RECTANGLE RECTANGULAR



ASSIETTE PLATE **181485**
DINNER 34 X 26 CM
COUPE PLATE 13 IN^{3/8} X 10 IN^{1/4}

207122
30 X 22 CM
11 IN^{13/16} X 8 IN^{11/16}

207110
26 X 18 CM
10 IN^{1/4} X 7 IN^{1/16}



PLAT **207754**
RECTANGULAIRE 40 X 16 CM
RECTANGULAR DISH, 15 IN^{3/4} X 6 IN^{5/16}
COUPE LARGE

207753
20 X 12 CM
7 IN^{7/8} X 4 IN^{3/4}

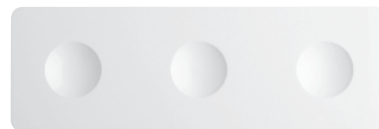

SUPPORT **161036**
PLATEAU 30,5 X 10 CM
TRAY STAND, 12 IN X 3 IN^{15/16}
3 PLACES

NEWCOOK MODULO



RAMEQUIN **162015**
RAMEKIN 9,5 CM - 3 IN^{3/4}



ASSIETTE **162011**
À CRÈME 14 CM - 5 IN^{1/2}
BRÛLÉE
«CRÈME BRÛLÉE»
DISH

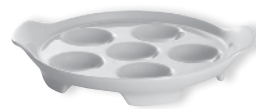

PLAT **164138**
À ESCARGOTS 16,6 X 11,2 CM -
6 PLACES 6 IN^{9/16} X 4 IN^{7/16}
SNAIL TRAY
6 SPACES





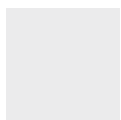

**BLANC
WHITE**
Porcelaine - Porcelain

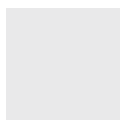

**BLANC SABLÉ
SANDY WHITE**
Porcelaine - Porcelain



**ONYX
BLACK ONYX**
Grés - Stoneware



**BLEU
AZUL**
Grés - Stoneware



**ROSE NUDE
PINK NUDE**
Porcelaine - Porcelain



**DUNE
BEIGE DUNE**
Grés - Stoneware



**BLEU DE ROCHE
BLUE STONE**
Grés - Stoneware

COCOTTES

Finedining
Porcelaine - Grès
Porcelain - Stoneware

MADE IN EUROPE



BLANC
WHITE
Porcelaine - Porcelain

BLANC SABLÉ
SANDY WHITE
Porcelaine - Porcelain

ONYX
BLACK ONYX
Grés - Stoneware
NEW

BLEU
AZUL
Grés - Stoneware

ROSE NUDE
PINK NUDE
Porcelaine - Porcelain

**ASSIETTE
COCOTTE (1)**
CASSEROLE
PLATE
22 CM - 8 IN^{11/16}
100 CL - 33 OZ^{13/16}



234342



234345



243821



234339

**ASSIETTE
COCOTTE (2)**
CASSEROLE
PLATE
18 CM - 7 IN^{7/16}
70 CL - 23 OZ^{11/16}



235064



235065



243830



235063

**BOL
COCOTTE**
ROUND
CASSEROLE
17,5 CM - 6 IN^{7/8}
140 CL - 47 OZ^{5/16}



234341



234344



243803



234338

**BOL
COCOTTE (3)**
ROUND
CASSEROLE
14 CM - 5 IN^{1/2}
50 CL - 16 OZ^{15/16}



209383



209720



236555



230821



243777

**ASSIETTE
COUVERCLE**
ROUND
PLATE/
CASSEROLE
LID
12,5 CM - 4 IN^{15/16}



209384



209384



236556



230820



243780

NEW
18 CM - 7 IN^{7/16}



245378



245378

**BOL BISEAUTÉ
COCOTTE**
SLANTED
RIM BOWL
16 CM - 6 IN^{5/16}
100 CL - 33 OZ^{13/16}



234340



234343



243821



234337

**BOL BISEAUTÉ
COCOTTE(4)**
SLANTED
RIM BOWL
12 CM - 4 IN^{3/4}
30 CL - 10 OZ^{1/8}



186849



211893



236554



230822



243786

**BOL BISEAUTÉ
COCOTTE**
SLANTED
RIM BOWL
7,3 CM - 2 IN^{7/8}
7 CL - 2 OZ^{3/8}



211891



211892



236553



230823



243783



(1) Compatible avec les assiettes de présentation
Compatible with the presentation plates



(2) Compatible avec les assiettes plates 28 cm
Compatible with the dinner plates 11 in

DUNE
BEIGE DUNE
Grés - Stoneware

BLEU DE ROCHE
BLUE STONE
Grés - Stoneware

ARGILE VERTE
GREEN CLAY
Grés - Stoneware

BASALTE
BROWN BASALT
Grés - Stoneware



NEW
243815



NEW
234339



NEW
243824



NEW
235063



NEW
243797



NEW
234338



230927



230972



230958



230944



230928



230973



230959



230945

EMPILABLE - STACKABLE



230926



230971



230957



230943



230925



230970



230956



230942



(3) Compatible avec les assiettes gourmet 30/32 cm
Compatible with the round shallow bowls 11 in^{13/15}/12 in^{5/8}



(4) Compatible avec les assiettes gourmet 28/30 cm
Compatible with the round shallow bowls 11 in/11 in^{13/16}





BLEU DE ROCHE
BLUE STONE
Grés - Stoneware



ARGILE VERTE
GREEN CLAY
Grés - Stoneware

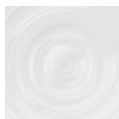

PIERRE DE LUNE
MOONSTONE
Porcelaine - Porcelain



ONYX
BLACK ONYX
Grés - Stoneware



BASALTE
BROWN BASALT
Grés - Stoneware



DUNE
BEIGE DUNE
Grés - Stoneware

BAHIA

Alldaydining
Porcelaine - Grès
Porcelain - Stoneware

MADE IN EUROPE



PIERRE DE LUNE
MOONSTONE
Porcelaine - Porcelain



ASSIETTE **239318**
PLATE EXT : 29 CM - 11 IN^{7/16}
ROUND INT : 25,5 CM - 10 IN^{1/16}
DINNER PLATE

239317
EXT : 26 CM - 10 IN^{1/4}
INT : 22 CM - 8 IN^{11/16}

239316
EXT : 23 CM - 9 IN^{1/16}
INT : 19,5 CM - 7 IN^{11/16}

DUNE
BEIGE DUNE
Grès - Stoneware



230921
EXT : 29 CM - 11 IN^{7/16}
INT : 25,5 CM - 10 IN^{1/16}

230920
EXT : 26 CM - 10 IN^{1/4}
INT : 22 CM - 8 IN^{11/16}

230919
EXT : 23 CM - 9 IN^{1/16}
INT : 19,5 CM - 7 IN^{11/16}

BLEU DE ROCHE
BLUE STONE
Grès - Stoneware



230966
EXT : 29 CM - 11 IN^{7/16}
INT : 25,5 CM - 10 IN^{1/16}

230965
EXT : 26 CM - 10 IN^{1/4}
INT : 22 CM - 8 IN^{11/16}

230964
EXT : 23 CM - 9 IN^{1/16}
INT : 19,5 CM - 7 IN^{11/16}



ASSIETTE **239315**
À PAIN EXT : 14 CM - 5 IN^{1/2}
ROUND INT : 10 CM - 3 IN^{15/16}
BREAD PLATE



230918
EXT : 14 CM - 5 IN^{1/2}
INT : 10 CM - 3 IN^{15/16}



230963
EXT : 14 CM - 5 IN^{1/2}
INT : 10 CM - 3 IN^{15/16}



ASSIETTE **239319**
CREUSE 45 CL - 15 OZ^{3/16}
ROUND EXT : 20 CM - 7 IN^{7/8}
CEREAL PLATE INT : 16,5 CM - 6 IN^{1/2}



230922
45 CL - 15 OZ^{3/16}
EXT : 20 CM - 7 IN^{7/8}
INT : 16,5 CM - 6 IN^{1/2}



230967
45 CL - 15 OZ^{3/16}
EXT : 20 CM - 7 IN^{7/8}
INT : 16,5 CM - 6 IN^{1/2}



ASSIETTE **209384**
COUVERCLE 12,5 CM - 4 IN^{15/16}
ROUND PLATE/
CASSEROLE LID



230928
12,5 CM - 4 IN^{15/16}



230973
12,5 CM - 4 IN^{15/16}



BOL COCOTTE **209720**
ROUND 50 CL - 16 OZ^{15/16}
CASSEROLE 14 CM - 5 IN^{1/2}



230927
50 CL - 16 OZ^{15/16}
14 CM - 5 IN^{1/2}



230972
50 CL - 16 OZ^{15/16}
14 CM - 5 IN^{1/2}



BOL **211893** **211892**
BISEAUTÉ 30 CL - 10 OZ^{1/8} 7 CL - 2 OZ^{3/8}
COCOTTE 12 CM - 4 IN^{3/4} 7,3 CM - 2 IN^{7/8}
SLANTED
RIM BOWL



230926 **230925**
30 CL - 10 OZ^{1/8} 7 CL - 2 OZ^{3/8}
12 CM - 4 IN^{3/4} 7,3 CM - 2 IN^{7/8}



230971 **230970**
30 CL - 10 OZ^{1/8} 7 CL - 2 OZ^{3/8}
12 CM - 4 IN^{3/4} 7,3 CM - 2 IN^{7/8}



ASSIETTE **239321**
GOURMET GRAND BASSIN
ROUND W/WIDE ROUND RIM
GOURMET EXT : 26 CM - 10 IN^{1/4}
PLATE INT : 14 CM - 5 IN^{1/2}

239320
PETIT BASSIN
W/WIDE ROUND RIM
EXT : 23 CM - 9 IN^{1/16}
INT : 11,5 CM - 4 IN^{1/2}



230924
GRAND BASSIN
W/WIDE ROUND RIM
EXT : 26 CM - 10 IN^{1/4}
INT : 14 CM - 5 IN^{1/2}

230923
PETIT BASSIN
W/WIDE ROUND RIM
EXT : 23 CM - 9 IN^{1/16}
INT : 11,5 CM - 4 IN^{1/2}



230969
GRAND BASSIN
W/WIDE ROUND RIM
EXT : 26 CM - 10 IN^{1/4}
INT : 14 CM - 5 IN^{1/2}

230968
PETIT BASSIN
W/WIDE ROUND RIM
EXT : 23 CM - 9 IN^{1/16}
INT : 11,5 CM - 4 IN^{1/2}

BASALTE
BROWN BASALT
Grés - Stoneware



230938
EXT : 29 CM - 11 IN^{7/16}
INT : 25,5 CM - 10 IN^{1/16}

230937
EXT : 26 CM - 10 IN^{1/4}
INT : 22 CM - 8 IN^{11/16}

230936
EXT : 23 CM - 9 IN^{1/16}
INT : 19,5 CM - 7 IN^{11/16}



230935
EXT : 14 CM - 5 IN^{1/2}
INT : 10 CM - 3 IN^{15/16}



230939
45 CL - 15 OZ^{3/16}
EXT : 20 CM - 7 IN^{7/8}
INT : 16,5 CM - 6 IN^{1/2}



230945
12,5 CM - 4 IN^{15/16}



230944
50 CL - 16 OZ^{15/16}
14 CM - 5 IN^{1/2}



230943 **230942**
30 CL - 10 OZ^{1/8} 7 CL - 2 OZ^{3/8}
12 CM - 4 IN^{3/4} 7,3 CM - 2 IN^{7/8}



230941
GRAND BASSIN
W/WIDE ROUND RIM
EXT : 26 CM - 10 IN^{1/4}
INT : 14 CM - 5 IN^{1/2}

230940
PETIT BASSIN
W/WIDE ROUND RIM
EXT : 23 CM - 9 IN^{1/16}
INT : 11,5 CM - 4 IN^{1/2}

ARGILE VERTE
GREEN CLAY
Grés - Stoneware



230952
EXT : 29 CM - 11 IN^{7/16}
INT : 25,5 CM - 10 IN^{1/16}

230951
EXT : 26 CM - 10 IN^{1/4}
INT : 22 CM - 8 IN^{11/16}

230950
EXT : 23 CM - 9 IN^{1/16}
INT : 19,5 CM - 7 IN^{11/16}



230949
EXT : 14 CM - 5 IN^{1/2}
INT : 10 CM - 3 IN^{15/16}



230953
45 CL - 15 OZ^{3/16}
EXT : 20 CM - 7 IN^{7/8}
INT : 16,5 CM - 6 IN^{1/2}



230959
12,5 CM - 4 IN^{15/16}



230958
50 CL - 16 OZ^{15/16}
14 CM - 5 IN^{1/2}



230957 **230956**
30 CL - 10 OZ^{1/8} 7 CL - 2 OZ^{3/8}
12 CM - 4 IN^{3/4} 7,3 CM - 2 IN^{7/8}



230955
GRAND BASSIN
W/WIDE ROUND RIM
EXT : 26 CM - 10 IN^{1/4}
INT : 14 CM - 5 IN^{1/2}

230954
PETIT BASSIN
W/WIDE ROUND RIM
EXT : 23 CM - 9 IN^{1/16}
INT : 11,5 CM - 4 IN^{1/2}

ONYX
BLACK ONYX
Grés - Stoneware



236549
EXT : 29 CM - 11 IN^{7/16}
INT : 25,5 CM - 10 IN^{1/16}

236548
EXT : 26 CM - 10 IN^{1/4}
INT : 22 CM - 8 IN^{11/16}

236547
EXT : 23 CM - 9 IN^{1/16}
INT : 19,5 CM - 7 IN^{11/16}



236546
EXT : 14 CM - 5 IN^{1/2}
INT : 10 CM - 3 IN^{15/16}



236550
45 CL - 15 OZ^{3/16}
EXT : 20 CM - 7 IN^{7/8}
INT : 16,5 CM - 6 IN^{1/2}



236556
12,5 CM - 4 IN^{15/16}



236555
50 CL - 16 OZ^{15/16}
14 CM - 5 IN^{1/2}



236554 **236553**
30 CL - 10 OZ^{1/8} 7 CL - 2 OZ^{3/8}
12 CM - 4 IN^{3/4} 7,3 CM - 2 IN^{7/8}



236552
GRAND BASSIN
W/WIDE ROUND RIM
EXT : 26 CM - 10 IN^{1/4}
INT : 14 CM - 5 IN^{1/2}

236551
PETIT BASSIN
W/WIDE ROUND RIM
EXT : 23 CM - 9 IN^{1/16}
INT : 11,5 CM - 4 IN^{1/2}



ASSIETTE COUVERCLE
ROUND PLATE/CASSEROLE LID

BOL COCOTTE
ROUND CASSEROLE

ASSIETTE GOURMET
GRAND BASSIN
ROUND GOURMET PLATE
W/WIDE ROUND RIM



ASSIETTE GOURMET
PETIT BASSIN
ROUND GOURMET PLATE
W/WIDE ROUND RIM

BOL BISEAUTÉ COCOTTE
SLANTED RIM BOWL



ACCESSOIRES ACCESSORIES

PIERRE DE LUNE
MOONSTONE
Porcelaine - Porcelain

DUNE
BEIGE DUNE
Grés - Stoneware

BLEU DE ROCHE
BLUE STONE
Grés - Stoneware

ONYX
BLACK ONYX
Grés - Stoneware

VERT ARGILE
GREEN CLAY
Grés - Stoneware



SALADIER 239325
BOWL 28 CM - 11 IN



235223
28 CM - 11 IN



235222
28 CM - 11 IN



240499
28 CM - 11 IN



PLANCHE 242054
RECTANGULAIRE 35 x 21 CM
RECTANGULAR 13 IN^{3/4} x 8 IN^{1/4}
BOARD



242056
35 x 21 CM
13 IN^{3/4} x 8 IN^{1/4}



242052
35 x 21 CM
13 IN^{3/4} x 8 IN^{1/4}



237206
25 X 13,5 CM
9 IN^{13/16} X 5 IN^{5/16}



234949
25 X 13,5 CM
9 IN^{13/16} X 5 IN^{5/16}

234948
25 X 13,5 CM
9 IN^{13/16} X 5 IN^{5/16}

234950
25 X 13,5 CM
9 IN^{13/16} X 5 IN^{5/16}



PLANCHE 242055
RONDE 29 CM - 11 IN^{7/16}
ROUND
BOARD



242057
29 CM - 11 IN^{7/16}

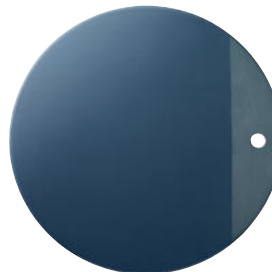

242053
29 CM - 11 IN^{7/16}

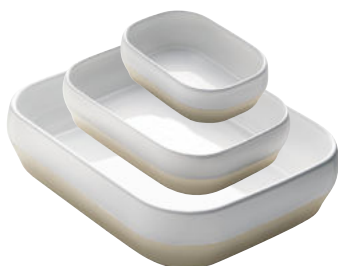

PLAT 241835
GRAND 31,8 x 25 x 7,4 CM
MODÈLE 12 IN^{1/2} x 9 IN^{13/16} x 2 IN^{15/16}
LARGE DISH

PLAT 241834
MOYEN 22,8 x 16,2 x 5,4 CM
MODÈLE 9 IN x 6 IN^{3/8} x 2 IN^{1/8}
MEDIUM DISH

PLAT 241833
PETIT 15,5 x 10,7 x 4,4 CM
MODÈLE 6 IN^{7/8} x 4 IN^{3/16} x 1 IN^{3/4}
SMALL DISH



237595
31,8 x 25 x 7,4 CM
12 IN^{1/2} x 9 IN^{13/16} x 2 IN^{15/16}

237594
22,8 x 16,2 x 5,4 CM
9 IN x 6 IN^{3/8} x 2 IN^{1/8}

237593
15,5 x 10,7 x 4,4 CM
6 IN^{7/8} x 4 IN^{3/16} x 1 IN^{3/4}





ROSÉE
PINK

SABLE
SAND

LAIT
WHITE MILK
NEW

TAUPE
TAUPE



ASSIETTE 241267
PLATE 26 CM - 10 IN^{1/4}

241275
26 CM - 10 IN^{1/4}

244749
26 CM - 10 IN^{1/4}

241271
26 CM - 10 IN^{1/4}

ROUND
DINNER
PLATE

241268
20 CM - 7 IN^{7/8}

241276
20 CM - 7 IN^{7/8}

244751
20 CM - 7 IN^{7/8}

241272
20 CM - 7 IN^{7/8}



BOL 241269
BOWL 20 CM - 7 IN^{7/8}
88 CL - 29 OZ^{3/4}

241277
20 CM - 7 IN^{7/8}
88 CL - 29 OZ^{3/4}

244753
20 CM - 7 IN^{7/8}
88 CL - 29 OZ^{3/4}

241273
20 CM - 7 IN^{7/8}
88 CL - 29 OZ^{3/4}



COUPELLE 241270
SMALL 12,5 CM - 4 IN^{5/16}
BOWL 23 CL - 7 OZ^{3/4}

241278
12,5 CM - 4 IN^{5/16}
23 CL - 7 OZ^{3/4}

244755
12,5 CM - 4 IN^{5/16}
23 CL - 7 OZ^{3/4}

241274
12,5 CM - 4 IN^{5/16}
23 CL - 7 OZ^{3/4}



BRUME

Alldaydining

Grès

Stoneware

MADE IN EUROPE





KAOLIN
KAOLIN



TERRE D'OMBRE
TAUPE



PIERRE DE LAVE
LAVA STONE



JADE
GREEN JADE

MODULO NATURE

Alldaydining

Grès
Stoneware



PIERRE DE LAVE
LAVA STONE

KAOLIN
KAOLIN

JADE
JADE GREEN
NEW

TERRE D'OMBRE
TAUPE



ASSIETTE 194455
PLATE 31,5 CM - 12 IN^{3/8}

184088
31,5 CM - 12 IN^{3/8}

235681
31,5 CM - 12 IN^{3/8}

184101
31,5 CM - 12 IN^{3/8}

ROUND
DINNER PLATE

194454
28 CM - 11 IN

184077
28 CM - 11 IN

235682
28 CM - 11 IN

184090
28 CM - 11 IN

194453
21 CM - 8 IN^{1/4}

184078
21 CM - 8 IN^{1/4}

235683
21 CM - 8 IN^{1/4}

184091
21 CM - 8 IN^{1/4}

230092
16 CM - 6 IN^{5/16}

209092
16 CM - 6 IN^{5/16}

235685
16 CM - 6 IN^{5/16}

209093
16 CM - 6 IN^{5/16}



ASSIETTE 194452
CALOTTE 21 CM - 8 IN^{1/4}

184079
21 CM - 8 IN^{1/4}

235684
21 CM - 8 IN^{1/4}

184092
21 CM - 8 IN^{1/4}

SALAD/
CEREAL PLATE



COUPE 194457
CALOTTE 17,7 CM - 6 IN^{15/16}
H 5,5 CM - 2 IN^{3/16}

184086
17,7 CM - 6 IN^{15/16}
H 5,5 CM - 2 IN^{3/16}

235687
17,7 CM - 6 IN^{15/16}
H 5,5 CM - 2 IN^{3/16}

184099
17,7 CM - 6 IN^{15/16}
H 5,5 CM - 2 IN^{3/16}

SALAD/
CEREAL PLATE
DEEP



COUPE RONDE 234455
ROUND 25 CM - 9 IN^{13/16}
COUPE BOWL

234449
25 CM - 9 IN^{13/16}

235688
25 CM - 9 IN^{13/16}

234451
25 CM - 9 IN^{13/16}

Disponible 2ème trimestre
Available second quarter



PIERRE DE LAVE
LAVA STONE

KAOLIN
KAOLIN

JADE
JADE GREEN
NEW

TERRE D'OMBRE
TAUPE



SALADIER 194462
SALAD BOWL 24 CM - 9 IN^{7/16}
H 8 CM - 3 IN^{3/16}



184087
24 CM - 9 IN^{7/16}
H 8 CM - 3 IN^{3/16}



235689
24 CM - 9 IN^{7/16}
H 8 CM - 3 IN^{3/16}



184100
24 CM - 9 IN^{7/16}
H 8 CM - 3 IN^{3/16}



BOL À DÉJEUNER 194456
SOUP/ 14 CM - 5 IN^{1/2}
BREAKFAST BOWL 58 CL - 19 OZ^{5/8}



184084
14 CM - 5 IN^{1/2}
58 CL - 19 OZ^{5/8}



246064
14 CM - 5 IN^{1/2}
58 CL - 19 OZ^{5/8}
Disponible 2ème trimestre
Available second quarter



184097
14 CM - 5 IN^{1/2}
58 CL - 19 OZ^{5/8}



COUPELLE 194458
SMALL 10 CM - 3 IN^{15/16}
BOWL/CUP H 6 CM - 2 IN^{3/8}



184085
10 CM - 3 IN^{15/16}
H 6 CM - 2 IN^{3/8}



235686
10 CM - 3 IN^{15/16}
H 6 CM - 2 IN^{3/8}



184098
10 CM - 3 IN^{15/16}
H 6 CM - 2 IN^{3/8}

CAFÉTERIE COFFEEWARE



TASSE À CAFÉ 194459
DEMITASSE CUP 11,5 CL - 3 OZ^{7/8}



184081
11,5 CL - 3 OZ^{7/8}



235690
11,5 CL - 3 OZ^{7/8}



184094
11,5 CL - 3 OZ^{7/8}

SOUCOUPE À CAFÉ 194460
DEMITASSE SAUCER 12,5 CM - Ø 4 IN^{15/16}

184082
12,5 CM - Ø 4 IN^{15/16}

235691
12,5 CM - Ø 4 IN^{15/16}

184095
12,5 CM - Ø 4 IN^{15/16}

TASSE À THÉ 230093
TEA CUP 25 CL - 8 OZ^{7/16}

230163
25 CL - 8 OZ^{7/16}

235692
25 CL - 8 OZ^{7/16}

230165
25 CL - 8 OZ^{7/16}

SOUCOUPE À THÉ 230094
DEMITASSE/TEA SAUCER 15 CM - Ø 5 IN^{7/8}

230164
15 CM - Ø 5 IN^{7/8}

235693
15 CM - Ø 5 IN^{7/8}

230166
15 CM - Ø 5 IN^{7/8}



MUG 194461
MUG 33 CL - 11 OZ^{3/16}



184083
33 CL - 11 OZ^{3/16}



184096
33 CL - 11 OZ^{3/16}





CAFÉTERIE
TEATIME

Le thé et le café sont des univers où le plaisir des sens est décuplé par le plaisir esthétique. Pour rendre ces instants de dégustation uniques, DEGRENNE propose une large sélection de tasses et accessoires. Collection iconique de la marque depuis 1953, redécouvrez SALAM et réunissez tous les éléments pour maîtriser l'Art du Thé.

Drinking tea and coffee is a sensory delight heightened by the sheer aesthetic pleasure of the experience. DEGRENNE offers a wide range of cups and accessories to make tea and coffee drinking a unique experience. An iconic DEGRENNE collection since 1953 - why not seize the opportunity to rediscover SALAM and gather together the essentials needed to be skilled in the art of tea.

BLANCHE
WHITE

Cloche aluminium zinc - Zinc aluminium lid



216416

6 TASSES - 6 CUPS
100 CL - 33 OZ^{13/16}

216412

4 TASSES - 4 CUPS
70 CL - 23 OZ^{1/16}

BLANCHE
WHITE

Cloche aluminium bronze - Bronze aluminium lid



216415

6 TASSES - 6 CUPS
100 CL - 33 OZ^{13/16}

216411

4 TASSES - 4 CUPS
70 CL - 23 OZ^{1/16}

BLANCHE
WHITE

Cloche aluminium bleue - Blue aluminium lid



225359

6 TASSES - 6 CUPS
100 CL - 33 OZ^{13/16}

225358

4 TASSES - 4 CUPS
70 CL - 23 OZ^{1/16}

BLANCHE
WHITE

Cloche inox dorée - Gold stainless steel lid



234217*

6 TASSES - 6 CUPS
100 CL - 33 OZ^{13/16}

234216*

4 TASSES - 4 CUPS
70 CL - 23 OZ^{1/16}

*Sur délai - With delay

NOIRE
BLACK

Cloche aluminium émeraude
Emerald aluminium lid



240138

6 TASSES - 6 CUPS
100 CL - 33 OZ^{13/16}

240125

4 TASSES - 4 CUPS
70 CL - 23 OZ^{1/16}

NOIRE
BLACK

Cloche aluminium bronze
Bronze aluminium lid



237415

6 TASSES - 6 CUPS
100 CL - 33 OZ^{13/16}

237414

4 TASSES - 4 CUPS
70 CL - 23 OZ^{1/16}

BLANCHE
WHITE

Cloche aluminium rouge pomme d'amour
Red aluminium lid candy apple



238934

6 TASSES - 6 CUPS
100 CL - 33 OZ^{13/16}

NOIRE
BLACK

Cloche aluminium rouge pomme d'amour
Red aluminium lid candy apple



238935

6 TASSES - 6 CUPS
100 CL - 33 OZ^{13/16}

ROSE
PINK

Cloche aluminium zinc
Zinc aluminium lid



236268

6 TASSES - 6 CUPS
100 CL - 33 OZ^{13/16}

236267

4 TASSES - 4 CUPS
70 CL - 23 OZ^{1/16}

OR
GOLD

Cloche blanche - White lid
Corps en porcelaine de Limoges
Limoges porcelain body



243794

4 TASSES - 4 CUPS
70 CL - 23 OZ^{1/16}

SALAM

Alldaydining
C ramique
Ceramic

MADE IN FRANCE



BLANCHE
WHITE

Cloche inox miroir - Mirror stainless steel lid



THÉIÈRE 211990
TEA POT 8 TASSES - 8 CUPS
130 CL - 43 OZ^{15/16}

211989
6 TASSES - 6 CUPS
100 CL - 33 OZ^{13/16}

211988
4 TASSES - 4 CUPS
70 CL - 23 OZ^{1/16}

211987
2 TASSES - 2 CUPS
35 CL - 11 OZ^{13/16}

NOIRE
BLACK

Cloche inox brossée - Brushed stainless steel lid



211994
8 TASSES - 8 CUPS
130 CL - 43 OZ^{15/16}

211993
6 TASSES - 6 CUPS
100 CL - 33 OZ^{13/16}

211992
4 TASSES - 4 CUPS
70 CL - 23 OZ^{1/16}

211991
2 TASSES - 2 CUPS
35 CL - 11 OZ^{13/16}

NOIRE
BLACK

Cloche aluminium noire mat - Black aluminium lid



216414
6 TASSES - 6 CUPS
100 CL - 33 OZ^{13/16}

216410
4 TASSES - 4 CUPS
70 CL - 23 OZ^{1/16}

243214
2 TASSES - 2 CUPS
35 CL - 11 OZ^{13/16}

ACCESSOIRES ACCESSORIES

BLANCHE
WHITE



CORPS 189949
THÉIÈRE 8 TASSES - 8 CUPS
TEA POT 130 CL - 43 OZ^{15/16}

189948
6 TASSES - 6 CUPS
100 CL - 33 OZ^{13/16}

189947
4 TASSES - 4 CUPS
70 CL - 23 OZ^{1/16}

189946
2 TASSES - 2 CUPS
35 CL - 11 OZ^{13/16}

NOIRE
BLACK



150447
8 TASSES - 8 CUPS
130 CL - 43 OZ^{15/16}

150456
6 TASSES - 6 CUPS
100 CL - 33 OZ^{13/16}

150455
4 TASSES - 4 CUPS
70 CL - 23 OZ^{1/16}

150450
2 TASSES - 2 CUPS
35 CL - 11 OZ^{13/16}



FEUTRE 217133
NOIR 8 TASSES - 8 CUPS
ISOLANT
BLACK
TEA POT
FELT 217132
6 TASSES - 6 CUPS

217131
4 TASSES - 4 CUPS

217130
2 TASSES - 2 CUPS



BOUCHON 205136
THÉIÈRE 6/8 TASSES - 6/8 CUPS
TEA POT LID

205135
2/4 TASSES - 2/4 CUPS



210576
6/8 TASSES - 6/8 CUPS

210575
2/4 TASSES - 2/4 CUPS



INFUSEUR 240331
STAINLESS
STEEL
FILTER 240330
4 TASSES - 4 CUPS



SUCRIER 187276
SUGAR
BOWL 28 CL - 9 OZ^{7/16}



CORPS 187283
SUCRIER
SUGAR
BOWL
WITHOUT
LID



150475 **150469**
28 CL - 9 OZ^{7/16}



150485
15 CL - 5 OZ^{1/16}

CRÉMIER 187277
CREAMER, JUG 15 CL - 5 OZ^{1/16}



SALAM

Alldaydining
C ramique
Ceramic

MADE IN FRANCE



MONOCHROME BLANC
MONOCHROME WHITE
Cloche inox blanche - White stainless steel lid



242322
6 TASSES - 6 CUPS
100 CL - 33 OZ^{13/16}

242321
4 TASSES - 4 CUPS
70 CL - 23 OZ^{1/16}

MONOCHROME BLEU GOURMET
MONOCHROME GOURMET BLUE
Cloche inox bleue - Blue stainless steel lid



242324
6 TASSES - 6 CUPS
100 CL - 33 OZ^{13/16}

242323
4 TASSES - 4 CUPS
70 CL - 23 OZ^{1/16}

MONOCHROME ROSE NUDE
MONOCHROME PINK NUDE
Cloche inox rose nude - Pink nude stainless steel lid



242326
6 TASSES - 6 CUPS
100 CL - 33 OZ^{13/16}

242325
4 TASSES - 4 CUPS
70 CL - 23 OZ^{1/16}

MONOCHROME VERT AMANDE
MONOCHROME ALMOND GREEN
Cloche inox vert amande - Almond green stainless steel lid



242328
6 TASSES - 6 CUPS
100 CL - 33 OZ^{13/16}

242327
4 TASSES - 4 CUPS
70 CL - 23 OZ^{1/16}



SALAM MONOCHROME

Alldaydining

C ramique

Ceramic

MADE IN FRANCE



BLANC
WHITE
Porcelaine - Porcelain



TASSE ESPRESSO 242636
ESPRESSO CUP 10 CL - 3 OZ^{3/8}

BLEU GOURMET
GOURMET BLUE
Grès - Stoneware



242640
10 CL - 3 OZ^{3/8}

ROSE NUDE
PINK NUDE
Grès - Stoneware



242642
10 CL - 3 OZ^{3/8}

VERT AMANDE
ALMOND GREEN
Grès - Stoneware



242638
10 CL - 3 OZ^{3/8}



TASSE À THÉ 242628
CAPPUCCINO 25 CL - 8 OZ^{29/64}
TEA AND
CAPPUCCINO CUP



242632
25 CL - 8 OZ^{29/64}



242634
25 CL - 8 OZ^{29/64}



242630
25 CL - 8 OZ^{29/64}



TASSE À DÉJEUNER 242620
BREAKFAST CUP 39 CL - 13 OZ^{3/16}



242624
39 CL - 13 OZ^{3/16}



242626
39 CL - 13 OZ^{3/16}



242622
39 CL - 13 OZ^{3/16}



SOUCOUPE 242644
CÉRAMIQUE 15 CM - 5 IN^{7/8}
CERAMIC SAUCER



242648
15 CM - 5 IN^{7/8}



242650
15 CM - 5 IN^{7/8}



242646
15 CM - 5 IN^{7/8}

INOX
STAINLESS STEEL



SOUCOUPE 242652
INOX 15 CM - 5 IN^{7/8}
STAINLESS
STEEL SAUCER



EMPILEO CAFETERIE

Alldaydining
C ramique
Ceramic

MADE IN EUROPE 



BLANC
WHITE



TASSE À CAFÉ 210946
COFFEE/TEA POT 11 CL - 3 OZ^{3/4}



SOUCOUPE CAFÉ/THÉ 210950
DEMITASSE 16 CM - 6 IN^{5/16}
COFFEE/TEA SAUCER



TASSE À THÉ 210947
COFFEE/TEA POT 25 CL - 8 OZ^{7/16}

**SOUCOUPE DÉJEUNER/
MUG 210951**
BREAKFAST MUG 18 CM - 7 IN^{1/16}
SAUCER



TASSE À DÉJEUNER 210948
BREAKFAST CUP 42 CL - 14 OZ^{3/16}



MUG À THÉ 210949
TEA MUG 38 CL - 12 OZ^{7/8}



SALAM THÉ

Alldaydining

Porcelaine

Porcelain

MADE IN EUROPE



L



TASSE ESPRESSO 227828
DEMITASSE CUP 10 CL - 3 OZ^{3/8} - 5,7 CM - 2 IN^{1/4}

SOUCOUBE ESPRESSO 227831
DEMITASSE SAUCER 12,6 CM - Ø 4 IN^{15/16}



TASSE LUNGO 227829
COFFEE/TEA CUP 25 CL - 8 OZ^{7/16} - 8,5 CM - 3 IN^{3/8}

SOUCOUBE LUNGO 227832
COFFEE/TEA SAUCER 15,8 CM - Ø 6 IN^{1/4}

L COUTURE



TASSE ESPRESSO 227828
DEMITASSE CUP 10 CL - 3 OZ^{3/8} - 5,7 CM - 2 IN^{1/4}

SOUCOUBE ESPRESSO 237404
DEMITASSE SAUCER 12,6 CM - Ø 4 IN^{15/16}



TASSE LUNGO 227829
COFFEE/TEA CUP 25 CL - 8 OZ^{7/16} - 8,5 CM - 3 IN^{3/8}

SOUCOUBE LUNGO 237405
COFFEE/TEA SAUCER 15,8 CM - Ø 6 IN^{1/4}

L FRAGMENT

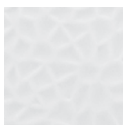

TASSE ESPRESSO 227828
DEMITASSE CUP 10 CL - 3 OZ^{3/8} - 5,7 CM - 2 IN^{1/4}

SOUCOUBE ESPRESSO 227849
DEMITASSE SAUCER 12,6 CM - Ø 4 IN^{15/16}



TASSE LUNGO 227829
COFFEE/TEA CUP 25 CL - 8 OZ^{7/16} - 8,5 CM - 3 IN^{3/8}

SOUCOUBE LUNGO 227850
COFFEE/TEA SAUCER 15,8 CM - Ø 6 IN^{1/4}

L PERLES DE ROSÉE

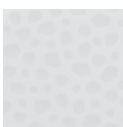

TASSE ESPRESSO 227828
DEMITASSE CUP 10 CL - 3 OZ^{3/8} - 5,7 CM - 2 IN^{1/4}

SOUCOUBE ESPRESSO 233928
DEMITASSE SAUCER 12,6 CM - Ø 4 IN^{15/16}



TASSE LUNGO 227829
COFFEE/TEA CUP 25 CL - 8 OZ^{7/16} - 8,5 CM - 3 IN^{3/8}

SOUCOUBE LUNGO 233929
COFFEE/TEA SAUCER 15,8 CM - Ø 6 IN^{1/4}

SD ONE



TASSE ESPRESSO 242910
ESPRESSO CUP H 6,3 CM - 2 IN^{1/2}
Ø 6 CM - 2 IN^{3/8}
7 CL - 2 OZ^{3/8}



TASSE THÉ/CAFÉ 242912
TEA/COFFEE CUP H 8 CM - 3 IN^{1/8}
Ø 7,8 CM - 3 IN^{11/16}
15 CL - 5 OZ^{1/16}

SOUCOUBE 242914
SAUCER Ø 14 CM - 5 IN^{1/2}





NEWPORT



TASSE ESPRESSO 207756
DEMITASSE CUP 10 CL - 3 OZ^{3/8}



TASSE LUNGO 207757
COFFEE/TEA CUP 20 CL - 6 OZ^{3/4}



TASSE DÉJEUNER 207758
BREAKFAST CUP 40 CL - 13 OZ^{1/2}

SOUCOUPE ESPRESSO 207759
DEMITASSE SAUCER 12,5 CM - Ø 4 IN^{5/16}

SOUCOUPE LUNGO 207760
COFFEE/TEA SAUCER 15,8 CM - Ø 5 IN^{7/8}

SOUCOUPE DÉJEUNER 207761
BREAKFAST SAUCER 18 CM - 7 IN^{7/16}



VERSEUSE 207764
COFFEE/TEA POT 80 CL - 27 OZ^{1/16}



CRÉMIER 207762
CREAM JUG 10 CL - 3 OZ^{3/8}



COUVERCLES VERSEUSES 210912
LIDS FOR TEA POTS 8,4 CM - 3 IN^{5/16}
80 CL - 27 OZ^{1/16}



207763
40 CL - 13 OZ^{1/2}

210911
6,6 CM - 2 IN^{5/8}
40 CL - 13 OZ^{1/2}

GRAPHIQUE CLASSIQUE NEW

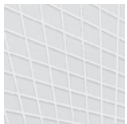

TASSE ESPRESSO 207756
DEMITASSE CUP 10 CL - 3 OZ^{3/8}



TASSE LUNGO 207757
COFFEE/TEA CUP 20 CL - 6 OZ^{3/4}

SOUCOUPE ESPRESSO 223406
DEMITASSE SAUCER 12,6 CM - Ø 4 IN^{15/16}

SOUCOUPE LUNGO 223407
COFFEE/TEA SAUCER 15 CM - Ø 5 IN^{7/8}

API



ASSIETTE PLATE RECTANGLE 207131
6 COMPARTIMENTS 27 X 18 CM
RECTANGULAR DINNER PLATE 10 IN^{5/8} X 7 IN^{1/16}
6 COMPARTMENTS



SOUCOUPE 207133
RECTANGULAIRE 27 X 9 CM
RECTANGULAR 10 IN^{5/8} X 3 IN^{9/16}
PLATE/SAUCER

SMOOS

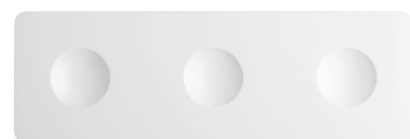

SUPPORT 161036
PLATEAU 30,5 X 10 CM
TRAY STAND, 12 IN X 3 IN^{15/16}
3 PLACES





PIERRE DE LAVE
LAVA STONE

KAOLIN
KAOLIN

TERRE D'OMBRE
TAUPE



TASSE À CAFÉ 194459
DEMITASSE CUP 11,5 CL - 3 OZ^{7/8}

SOUCOUE À CAFÉ 194460
DEMITASSE SAUCER 12,5 CM - Ø 4 IN^{15/16}

TASSE À THÉ 230093
TEA CUP 25 CL - 8 OZ^{7/16}

SOUCOUE À THÉ 230094
DEMITASSE/TEA SAUCER 15 CM - Ø 5 IN^{7/8}



184081
11,5 CL - 3 OZ^{7/8}

184082
12,5 CM - Ø 4 IN^{15/16}

230163
25 CL - 8 OZ^{7/16}

230164
15 CM - Ø 5 IN^{7/8}



184094
11,5 CL - 3 OZ^{7/8}

184095
12,5 CM - Ø 4 IN^{15/16}

230165
25 CL - 8 OZ^{7/16}

230166
15 CM - Ø 5 IN^{7/8}



MUG 194461
MUG 33 CL - 11 OZ^{3/16}



184083
33 CL - 11 OZ^{3/16}



184096
33 CL - 11 OZ^{3/16}



MODULO NATURE

Alldaydining

Grès

Stoneware





DEGRENE
PARIS
MADE IN FRANCE



LES COUVERTS FLATWARE

Les ateliers DEGRENNE donnent forme aux majestueuses bobines d'acier inoxydable et transforment la matière brute en couverts. Les couverts DEGRENNE bénéficient d'un savoir-faire unique et se caractérisent par une ergonomie et une résistance exceptionnelle.

Faciles d'entretien, ils répondent aux critères les plus exigeants de qualité, de fonctionnalité et d'esthétique. La qualité du design et le soin apporté aux finitions font de chacun de nos couverts de véritables pièces d'orfèvre de style classique ou contemporain. Créé en collaboration avec des chefs ou en laissant libre cours à l'imagination de nos designers, aux lignes sobres ou plus élaborées, chaque modèle DEGRENNE trouve sa place à table.

DEGRENNE'S workshops shape the impressive reels of stainless steel and transform the raw material into cutlery. We use our unique expertise to create our cutlery, which is characterized by being extraordinarily easy to use and sturdy. DEGRENNE cutlery is easy to look after and meets the most stringent quality, functionality and appearance criteria. The design quality and painstaking finishes make each of our items of cutlery true pieces of classic or contemporary silverware. DEGRENNE cutlery is designed in partnership with chefs or by giving our designers free rein. Some items have simple lines, while others are more elaborate, but every DEGRENNE design takes pride of place on a table.

Découvrez les coulisses de notre
manufacture à Vire

Discover our factory in Vire







LES
COUVERTS
DESIGN
DESIGN FLATWARE



241006
FOURCHETTE DE TABLE
 TABLE FORK
 20,6 CM - 8 IN^{1/2}



241010
COUTEAU DE TABLE MONOBLOC LAME SCIE
 TABLE KNIFE SOLID HANDLE SERRATED
 23,9 CM - 9 IN^{7/16}



241004
CUILLÈRE DE TABLE
 TABLE/PASTA SPOON
 20,7 CM - 8 IN^{1/8}



241032
CUILLÈRE À SOUPE ANGLAISE
 BOUILLON SPOON, ROUND
 17,4 CM - 6 IN^{7/8}



241008
CUILLÈRE À CAFÉ
 COFFEE/TEA SPOON
 14,2 CM - 5 IN^{9/16}



241012
CUILLÈRE À DESSERT
 DESSERT/SOUP SPOON, OVAL
 18,6 CM - 7 IN^{5/16}



241014
FOURCHETTE À DESSERT
 DESSERT/SALAD FORK
 18,5 CM - 7 IN^{5/16}



241016
COUTEAU À DESSERT MONOBLOC LAME UNIE
 DESSERT KNIFE SOLID HANDLE
 21,5 CM - 8 IN^{7/16}



241018
CUILLÈRE À MOKA
 DEMI TASSE SPOON
 11,2 CM - 4 IN^{7/16}



241026
FOURCHETTE À POISSON
 FISH FORK
 18,5 CM - 7 IN^{5/16}



241028
COUTEAU À POISSON
 FISH KNIFE
 20,6 CM - 8 IN^{1/8}



241030
COUTEAU À BEURRE MONOBLOC
 BUTTER KNIFE SOLID HANDLE
 18,6 CM - 7 IN^{5/16}



241020
CUILLÈRE DE SERVICE
 SERVING SPOON
 26,1 CM - 10 IN^{1/4}



241021
FOURCHETTE DE SERVICE
 SERVING FORK
 26 CM - 10 IN^{1/4}





205559
FOURCHETTE DE TABLE
TABLE FORK
21,3 CM - 8 IN^{3/8}



193776
COUTEAU DE TABLE
MONOBLOC LAME SCIE
TABLE KNIFE SOLID HANDLE SERRATED
23,3 CM - 9 IN^{3/16}



205560
CUILLÈRE DE TABLE
TABLE/PASTA SPOON
20,5 CM - 8 IN^{1/16}



205561
CUILLÈRE À SOUPE ANGLAISE
BOUILLON SPOON, ROUND
18,5 CM - 7 IN^{5/16}



205567
CUILLÈRE GOURMANDE
DESSERT /SOUP SPOON, OVAL
18,6 CM - 7 IN^{5/16}



205566
FOURCHETTE GOURMANDE
DESSERT/SALAD FORK
18,6 CM - 7 IN^{5/16}



181111
COUTEAU À DESSERT
MONOBLOC LAME UNIE
DESSERT KNIFE SOLID HANDLE
20,6 CM - 8 IN^{1/8}



181112
TARTINEUR
BUTTER SPREADER
16 CM - 6 IN^{5/16}



205563
FOURCHETTE À POISSON
FISH FORK
20 CM - 7 IN^{7/8}



205564
SPATULE GOURMET
GOURMET SPATULA
20,2 CM - 7 IN^{15/16}



205565
FOURCHETTE GOURMET
GOURMET FORK
20 CM - 7 IN^{7/8}



205562
CUILLÈRE À CAFÉ
COFFEE/TEA SPOON
14,3 CM - 5 IN^{5/8}



181109
CUILLÈRE À MOKA
DEMI TASSE SPOON
11 CM - 4 IN^{5/16}



190018
CUILLÈRE À SODA
ICED TEA SPOON
19 CM - 7 IN^{1/2}



181119
FOURCHETTE MISE EN BOUCHE
COCKTAIL FORK
15,5 CM - 6 IN^{1/8}



181120
SPATULE MISE EN BOUCHE
COCKTAIL SPATULA
15,5 CM - 6 IN^{1/8}



181121
CUILLÈRE MISE EN BOUCHE
COCKTAIL SPOON
11,6 CM - 4 IN^{9/16}



190424
FOURCHETTE À HÙITRES
OYSTER FORK
14,1 CM - 5 IN^{3/16}



181114
FOURCHETTE DE SERVICE
SERVING FORK
26 CM - 10 IN^{1/4}



181113
CUILLÈRE DE SERVICE
SERVING SPOON
26 CM - 10 IN^{1/4}



181122
SPATULE DE SERVICE
SERVING SPATULA
25 CM - 9 IN^{13/16}



189999
SERVICE À SALADE
SALAD SERVING SET
30 CM - 11 IN^{13/16}



153193
LOUCHE
SOUP LADLE
29,7 CM - 11 IN^{11/16}



154606
LOUCHE À SAUCE
SAUCE LADLE
18,5 CM - 7 IN^{5/16}

Possibilité de personnalisation
Bespoke options available

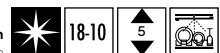

XY

Finedining

MADE IN FRANCE





205568
FOURCHETTE DE TABLE
TABLE FORK
21,3 CM - 8 IN^{3/8}



195028
COUTEAU DE TABLE
MONOBLOC LAME SCIE
TABLE KNIFE SOLID HANDLE SERRATED
23,3 CM - 9 IN^{3/16}



205569
CUILLÈRE DE TABLE
TABLE/PASTA SPOON
20,5 CM - 8 IN^{1/16}



200483
CUILLÈRE À SOUPE ANGLAISE
BOUILLON SPOON, ROUND
18,5 CM - 7 IN^{5/16}



205575
CUILLÈRE GOURMANDE
DESSERT/SOUP SPOON, OVAL
18,6 CM - 7 IN^{5/16}



205574
FOURCHETTE GOURMANDE
DESSERT/SALAD FORK
18,6 CM - 7 IN^{5/16}



195031
COUTEAU À DESSERT
MONOBLOC LAME UNIE
DESSERT KNIFE SOLID HANDLE
20,6 CM - 8 IN^{1/8}



195036
TARTINEUR
BUTTER SPREADER
16 CM - 6 IN^{5/16}



205571
FOURCHETTE À POISSON
FISH FORK
20 CM - 7 IN^{7/8}



205572
SPATULE GOURMET
GOURMET SPATULA
20,2 CM - 7 IN^{15/16}



205573
FOURCHETTE GOURMET
GOURMET FORK
20 CM - 7 IN^{7/8}



205570
CUILLÈRE À CAFÉ
COFFEE/TEA SPOON
14,3 CM - 5 IN^{5/8}



195034
CUILLÈRE À MOKA
DEMI TASSE SPOON
11 CM - 4 IN^{9/16}



196674
CUILLÈRE À SODA
ICED TEA SPOON
19 CM - 7 IN^{1/2}



195039
FOURCHETTE MISE EN BOUCHE
COCKTAIL FORK
15,5 CM - 6 IN^{1/8}



195042
SPATULE MISE EN BOUCHE
COCKTAIL SPATULA
15,5 CM - 6 IN^{1/8}



195041
CUILLÈRE MISE EN BOUCHE
COCKTAIL SPOON
11,6 CM - 4 IN^{9/16}



196014
FOURCHETTE À HÙÎTRES
OYSTER FORK
14,1 CM - 5 IN^{3/16}



199773
FOURCHETTE DE SERVICE
SERVING FORK
26 CM - 10 IN^{1/4}



199774
CUILLÈRE DE SERVICE
SERVING SPOON
26 CM - 10 IN^{1/4}



199769
SPATULE DE SERVICE
SERVING SPATULA
25 CM - 9 IN^{13/16}



199771
SERVICE À SALADE
SALAD SERVING SET
30 CM - 11 IN^{13/16}



XY BLACK MIROIR

Finedining

MADE IN FRANCE





205540
FOURCHETTE DE TABLE
TABLE FORK
20,9 CM - 8 IN^{3/16}



205544
FOURCHETTE À POISSON
FISH FORK
18,4 CM - 7 IN^{1/4}



159484
COUTEAU DE TABLE
MONOBLOC LAME SCIE
TABLE KNIFE SOLID HANDLE SERRATED
23,2 CM - 9 IN^{1/8}



205545
COUTEAU À POISSON/GOURMET
GOURMET FISH KNIFE
20,7 CM - 8 IN^{5/8}



208624
COUTEAU DE TABLE
MONOBLOC LAME SCIE
TABLE KNIFE SOLID HANDLE SERRATED
23 CM - 9 IN^{1/8}



205543
CUILLÈRE À CAFÉ
COFFEE/TEA SPOON
14 CM - 5 IN^{1/2}



235481
COUTEAU DE TABLE
MONOBLOC LAME SCIE
TABLE KNIFE SOLID HANDLE SERRATED
23,7 CM - 9 IN^{5/16}



159512
CUILLÈRE À MOKA
DEMI TASSE SPOON
11,1 CM - 4 IN^{3/8}



159451
COUTEAU À STEAK
MONOBLOC LAME SCIE
STEAK KNIFE SOLID HANDLE SERRATED
23,5 CM - 9 IN^{1/4}



190018
CUILLÈRE À SODA
ICED TEA SPOON
19 CM - 7 IN^{1/2}



235482
COUTEAU DESSERT
MONOBLOC LAME UNIE
DESSERT KNIFE SOLID HANDLE
21,3 CM - 8 IN^{3/8}



205548
FOURCHETTE À GÂTEAUX/COCKTAIL
PASTRY/COCKTAIL FORK
14,3 CM - 5 IN^{5/8}



205541
CUILLÈRE DE TABLE
TABLE/PASTA SPOON
20,9 CM - 8 IN^{1/4}



159501
FOURCHETTE DE SERVICE
SERVING FORK
26 CM - 10 IN^{1/4}



205547
CUILLÈRE À DESSERT
DESSERT/SOUP SPOON, OVAL
18,4 CM - 7 IN^{1/4}



159500
CUILLÈRE DE SERVICE
SERVING SPOON
26 CM - 10 IN^{1/4}



205546
FOURCHETTE À DESSERT
DESSERT/SALAD FORK
18,4 CM - 7 IN^{1/4}



153193
LOUCHE
SOUP LADLE
29,7 CM - 11 IN^{11/16}



159492
COUTEAU À DESSERT
MONOBLOC LAME UNIE
DESSERT KNIFE SOLID HANDLE
20,4 CM - 8 IN^{1/16}



154606
CUILLÈRE À SAUCE
SAUCE SPOON
18,5 CM - 7 IN^{5/16}



208625
COUTEAU À DESSERT
MONOBLOC LAME SCIE
DESSERT KNIFE SOLID HANDLE
SERRATED
20,7 CM - 8 IN^{1/8}



181112
TARTINEUR
BUTTER SPREADER
16 CM - 6 IN^{5/16}

SOLSTICE

Alldaydining

MADE IN FRANCE





239122
FOURCHETTE DE TABLE
TABLE FORK
20,5 CM - 8 IN^{17/16}



233013
COUTEAU DE TABLE
MONOBLOC À BOUT POINTU
LAME SCIE
TABLE KNIFE SOLID HANDLE POINTED
BLADE SERRATED
23,3 CM - 9 IN^{3/16}



233014 - *239124
COUTEAU DE TABLE
MONOBLOC À BOUT ROND
LAME SCIE
TABLE KNIFE SOLID HANDLE ROUNDED
BLADE SERRATED
23,3 CM - 9 IN^{3/16}



233012 - *239121
CUILLÈRE DE TABLE
TABLE/PASTA SPOON
20,5 CM - 8 IN^{17/16}



233022
CUILLÈRE À SOUPE ANGLAISE
BOUILLON SPOON, ROUND
18,5 CM - 7 IN^{5/16}



239128
CUILLÈRE À DESSERT
DESSERT/SOUP SPOON, OVAL
18,5 CM - 7 IN^{5/16}



233017 - *239127
FOURCHETTE À DESSERT
DESSERT/SALAD FORK
18,5 CM - 7 IN^{5/16}



233019 - *239129
COUTEAU À DESSERT
MONOBLOC À BOUT ROND
LAME UNIE
DESSERT KNIFE SOLID HANDLE
ROUNDED BLADE
20,9 CM - 8 IN¹⁴



239133
COUTEAU À BEURRE
MONOBLOC LAME UNIE
BUTTER KNIFE SOLID HANDLE
17,5 CM - 6 IN^{7/8}



233021 - *239131
CUILLÈRE GOURMET
GOURMET SPOON
18,5 CM - 7 IN^{5/16}



239125
CUILLÈRE À CAFÉ
COFFEE/TEA SPOON
13,9 CM - 5 IN^{1/2}



239126
CUILLÈRE À MOKA
DEMI TASSE SPOON
11,7 CM - 4 IN^{5/8}



239134
FOURCHETTE DE SERVICE
SERVING FORK
26,3 CM - 10 IN^{3/8}



239135
CUILLÈRE DE SERVICE
SERVING SPOON
26,3 CM - 10 IN^{3/8}

L'E STARCK®

Alldaydining

MADE IN FRANCE





197507
FOURCHETTE DE TABLE
TABLE FORK
21,3 CM - 8 IN^{3/8}



197509
COUTEAU DE TABLE MONOBLOC LAME SCIE
TABLE KNIFE SOLID HANDLE SERRATED
23,2 CM - 9 IN^{3/8}



235481
COUTEAU DE TABLE MONOBLOC LAME SCIE
TABLE KNIFE SOLID HANDLE SERRATED
23,7 CM - 9 IN^{5/16}



197521
COUTEAU À STEAK MONOBLOC LAME SCIE
STEAK KNIFE SOLID HANDLE SERRATED
23,2 CM - 9 IN^{3/8}



197506
CUILLÈRE DE TABLE
TABLE/PASTA SPOON
21,6 CM - 8 IN^{1/2}



197518
CUILLÈRE À SOUPE ANGLAISE
BOUILLON SPOON, ROUND
18,5 CM - 7 IN^{5/16}



197512
CUILLÈRE À DESSERT
DESSERT/SOUP SPOON, OVAL
19,5 CM - 7 IN^{11/16}



197511
FOURCHETTE À DESSERT
DESSERT/SALAD FORK
19,2 CM - 7 IN^{9/16}



210629
COUTEAU À DESSERT MONOBLOC LAME SCIE
DESSERT KNIFE SOLID HANDLE SERRATED
20,9 CM - 8 IN^{3/16}



235482
COUTEAU À DESSERT MONOBLOC LAME UNIE
DESSERT KNIFE SOLID HANDLE
21,3 CM - 8 IN^{3/8}



197520
COUTEAU À BEURRE MONOBLOC LAME UNIE
BUTTER KNIFE SOLID HANDLE
19,3 CM - 7 IN^{5/8}



181112
TARTINEUR
BUTTER SPREADER
16 CM - 6 IN^{5/16}



197514
FOURCHETTE À POISSON
FISH FORK
19,2 CM - 7 IN^{9/16}



197515
COUTEAU À POISSON/GOURMET
GOURMET FISH KNIFE
21,3 CM - 8 IN^{3/8}



197508
CUILLÈRE À CAFÉ
COFFEE/TEA SPOON
14,3 CM - 5 IN^{5/8}



197510
CUILLÈRE À MOKA
DEMI TASSE SPOON
11,7 CM - 4 IN^{5/8}



190018
CUILLÈRE À SODA
ICED TEA SPOON
19 CM - 7 IN^{1/2}



197516
FOURCHETTE À GÂTEAUX/COCKTAIL
PASTRY/COCKTAIL FORK
13,9 CM - 5 IN^{1/2}



190424
FOURCHETTE À HÙITRES
OYSTER FORK
14,1 CM - 5 IN^{9/16}



197522
FOURCHETTE DE SERVICE
SERVING FORK
26,6 CM - 10 IN^{1/2}



197523
CUILLÈRE DE SERVICE
SERVING SPOON
27 CM - 10 IN^{5/8}



197525
SERVICE À SALADE
SALAD SERVING SET
30 CM - 11 IN^{13/16}



197527
PELLE À TARTE MONOBLOC
PASTRY SERVER SOLID HANDLE
25,1 CM - 9 IN^{7/8}



153193
LOUCHE
SOUP LADLE
29,7 CM - 11 IN^{11/16}



154606
CUILLÈRE À SAUCE
SAUCE LADLE
18,5 CM - 7 IN^{3/16}

Possibilité de personnalisation
Bespoke options available

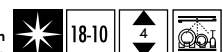

GUEST MIROIR

Finedining





223482
FOURCHETTE DE TABLE
TABLE FORK
21,3 CM - 8 IN^{3/8}



202995
COUPEAU DE TABLE
MONOBLOC LAME SCIE
TABLE KNIFE SOLID HANDLE SERRATED
23,2 CM - 9 IN^{1/8}



203017
COUPEAU À STEAK
MONOBLOC LAME SCIE
STEAK KNIFE SOLID HANDLE SERRATED
23,2 CM - 9 IN^{1/8}



223481
CUILLÈRE DE TABLE
TABLE/PASTA SPOON
21,6 CM - 8 IN^{1/2}



223491
CUILLÈRE À SOUPE ANGLAISE
BOUILLON SPOON, ROUND
18,5 CM - 7 IN^{5/16}



223486
CUILLÈRE À DESSERT
DESSERT/SOUP SPOON, OVAL
19,5 CM - 7 IN^{11/16}



223485
FOURCHETTE À DESSERT
DESSERT/SALAD FORK
19,2 CM - 7 IN^{9/16}



210630
COUPEAU À DESSERT
MONOBLOC LAME SCIE
DESSERT KNIFE SOLID HANDLE
SERRATED
20,9 CM - 8 IN^{3/16}



203016
COUPEAU À BEURRE
MONOBLOC LAME UNIE
BUTTER KNIFE SOLID HANDLE
19,3 CM - 7 IN^{5/8}



223487
FOURCHETTE À POISSON
FISH FORK
19,2 CM - 7 IN^{9/16}



223488
COUPEAU À POISSON/GOURMET
GOURMET FISH KNIFE
21,3 CM - 8 IN^{3/8}



223483
CUILLÈRE À CAFÉ
COFFEE/TEA SPOON
14,3 CM - 5 IN^{5/8}



223484
CUILLÈRE À MOKA
DEMI TASSE SPOON
11,7 CM - 4 IN^{5/8}



223492
CUILLÈRE À SODA
ICED TEA SPOON
18,9 CM - 7 IN^{7/16}



223489
FOURCHETTE À GÂTEAUX/COCKTAIL
PASTRY/COCKTAIL FORK
13,9 CM - 5 IN^{1/2}



223493
FOURCHETTE DE SERVICE
SERVING FORK
26,6 CM - 10 IN^{1/2}



223494
CUILLÈRE DE SERVICE
SERVING SPOON
27 CM - 10 IN^{5/8}



223497
PELLE À TARTE MONOBLOC
PASTRY SERVER SOLID HANDLE
25,1 CM - 9 IN^{7/8}

GUEST STAR

Finedining



GUEST CUIVRE COPPER



230848
FOURCHETTE DE TABLE
TABLE FORK
21,3 CM - 8 IN^{3/8}



230850
COUPEAU DE TABLE
MONOBLOC LAME SCIE
TABLE KNIFE SOLID HANDLE SERRATED
23,2 CM - 9 IN^{1/8}



230849
CUILLÈRE DE TABLE
TABLE/PASTA SPOON
21,6 CM - 8 IN^{1/2}



230854
CUILLÈRE À DESSERT
DESSERT/SOUP SPOON, OVAL
19,5 CM - 7 IN^{11/16}



230853
FOURCHETTE À DESSERT
DESSERT/SALAD FORK
19,2 CM - 7 IN^{9/16}



230855
COUPEAU À DESSERT
MONOBLOC LAME SCIE
DESSERT KNIFE SOLID HANDLE
SERRATED
20,9 CM - 8 IN^{3/16}



230851
CUILLÈRE À CAFÉ
COFFEE/TEA SPOON
14,3 CM - 5 IN^{5/8}



230852
CUILLÈRE À MOKA
DEMI TASSE SPOON
11,7 CM - 4 IN^{5/8}



GUEST CUIVRE

Finedining





217139
FOURCHETTE DE TABLE
 TABLE FORK
 21,3 CM - 8 IN^{3/8}



217140
COUTEAU DE TABLE
MONOBLOC LAME SCIE
 TABLE KNIFE SOLID HANDLE SERRATED
 23,2 CM - 9 IN^{1/8}



230339
COUTEAU À STEAK
MONOBLOC LAME SCIE
 STEAK KNIFE SOLID HANDLE SERRATED
 23,2 CM - 9 IN^{1/8}



217141
CUILLÈRE DE TABLE
 TABLE/PASTA SPOON
 21,6 CM - 8 IN^{1/2}



217143
CUILLÈRE À DESSERT
 DESSERT/SOUP SPOON, OVAL
 19,5 CM - 7 IN^{11/16}



217144
FOURCHETTE À DESSERT
 DESSERT/SALAD FORK
 19,2 CM - 7 IN^{9/16}



217145
COUTEAU À DESSERT
MONOBLOC LAME SCIE
 DESSERT KNIFE SOLID HANDLE
 SERRATED
 20,9 CM - 8 IN^{3/16}



217142
CUILLÈRE À CAFÉ
 COFFEE/TEA SPOON
 14,3 CM - 5 IN^{5/8}



217146
CUILLÈRE À MOKA
 DEMI TASSE SPOON
 11,7 CM - 4 IN^{5/8}

GUEST VINTAGE

Finedining





236700
FOURCHETTE DE TABLE
 TABLE FORK
 21,5 CM - 8 IN^{7/16}



236702
COUTEAU DE TABLE
MONOBLOC LAME SCIE
 TABLE KNIFE SOLID HANDLE SERRATED
 21,5 CM - 8 IN^{7/16}



111970
COUTEAU DE TABLE
MONOBLOC LAME SCIE
 TABLE KNIFE SOLID HANDLE SERRATED
 23 CM - 9 IN^{1/16}



236701
CUILLÈRE DE TABLE
 TABLE/PASTA SPOON
 21,5 CM - 8 IN^{7/16}



236726
CUILLÈRE À SOUPE ANGLAISE
 BOUILLON SPOON, ROUND
 18,5 CM - 7 IN^{5/16}



236721
CUILLÈRE À DESSERT
 DESSERT/SOUP SPOON, OVAL
 19,1 CM - 7 IN^{1/2}



236719
FOURCHETTE À DESSERT
 DESSERT/SALAD FORK
 19,1 CM - 7 IN^{1/2}



236720
COUTEAU À DESSERT
MONOBLOC LAME UNIE
 DESSERT KNIFE SOLID HANDLE
 19,2 CM - 7 IN^{9/16}



236727
TARTINEUR
 BUTTER SPREADER
 16,5 CM - 6 IN^{1/2}



181112
TARTINEUR
 BUTTER SPREADER
 16 CM - 6 IN^{5/16}



236703
CUILLÈRE À CAFÉ
 COFFEE/TEA SPOON
 15 CM - 5 IN^{7/8}



236722
CUILLÈRE À MOKA
 DEMI TASSE SPOON
 11 CM - 4 IN^{9/16}



236724
FOURCHETTE DE SERVICE
 SERVING FORK
 26 CM - 10 IN^{1/4}



236723
CUILLÈRE DE SERVICE
 SERVING SPOON
 26 CM - 10 IN^{1/4}

FUSE

Finedining



FUSE MARTELÉ HAMMERED



236790
FOURCHETTE DE TABLE
TABLE FORK
21,5 CM - 8 IN^{7/16}



236791
COUPEAU DE TABLE
MONOBLOC LAME SCIE
TABLE KNIFE SOLID HANDLE SERRATED
21,5 CM - 8 IN^{7/16}



236789
CUILLÈRE DE TABLE
TABLE/PASTA SPOON
21,5 CM - 8 IN^{7/16}



236802
CUILLÈRE À SOUPE ANGLAISE
BOUILLON SPOON, ROUND
18,5 CM - 7 IN^{5/16}



236796
CUILLÈRE À DESSERT
DESSERT/SOUP SPOON, OVAL
19,1 CM - 7 IN^{1/2}



236794
FOURCHETTE À DESSERT
DESSERT/SALAD FORK
19,1 CM - 7 IN^{1/2}



236795
COUPEAU À DESSERT
MONOBLOC LAME UNIE
DESSERT KNIFE SOLID HANDLE
19,2 CM - 7 IN^{9/16}



236804
TARTINEUR
BUTTER SPREADER
16,5 CM - 6 IN^{1/2}



236798
CUILLÈRE À CAFÉ
COFFEE/TEA SPOON
15 CM - 5 IN^{7/8}



236797
CUILLÈRE À MOKA
DEMI TASSE SPOON
11 CM - 4 IN^{5/16}



236806
PIC APÉRO
COCKTAIL PICK
15 CM - 5 IN^{1/8}



236805
FOURCHETTE/PIQUE À
ESCARGOTS/COCKTAIL
COCKTAIL, SNAIL FORK
15 CM - 5 IN^{7/8}



236800
FOURCHETTE DE SERVICE
SERVING FORK
26 CM - 10 IN^{1/4}



236799
CUILLÈRE DE SERVICE
SERVING SPOON
26 CM - 10 IN^{1/4}

FUSE MARTELÉ

Finedining





126355
FOURCHETTE DE TABLE
TABLE FORK
20,1 CM - 7 IN^{5/16}



210731
COUTEAU DE TABLE
MONOBLOC LAME SCIE
TABLE KNIFE SOLID HANDLE SERRATED
23,5 CM - 9 IN^{1/4}



126352
CUILLÈRE DE TABLE
TABLE/PASTA SPOON
20,3 CM - 8 IN



140855
CUILLÈRE À SOUPE ANGLAISE
BOUILLON SPOON, ROUND
17,9 CM - 7 IN^{7/16}



126368
CUILLÈRE À DESSERT
DESSERT/SOUP SPOON, OVAL
17,8 CM - 7 IN



126371
FOURCHETTE À DESSERT
DESSERT/SALAD FORK
17,7 CM - 6 IN^{5/16}



210732
COUTEAU À DESSERT
MONOBLOC LAME UNIE
DESSERT KNIFE SOLID HANDLE
20,7 CM - 8 IN^{1/8}



189971
COUTEAU À BEURRE
MONOBLOC LAME UNIE
BUTTER KNIFE SOLID HANDLE
18,9 CM - 7 IN^{7/16}



126377
FOURCHETTE À POISSON
FISH FORK
17,7 CM - 6 IN^{5/16}



181181
COUTEAU À POISSON/
GOURMET
GOURMET FISH KNIFE
20,1 CM - 7 IN^{5/16}



126358
CUILLÈRE À CAFÉ
COFFEE/TEA SPOON
13,7 CM - 5 IN^{3/8}



140852
CUILLÈRE À MOKA
DEMI TASSE SPOON
11 CM - 4 IN^{5/16}



189973
CUILLÈRE À SODA
ICED TEA SPOON
19 CM - 7 IN^{1/2}



126383
FOURCHETTE À GÂTEAUX
COCKTAIL
PASTRY/COCKTAIL FORK
13,7 CM - 5 IN^{3/8}



189974
FOURCHETTE À HUÎTRES
OYSTER FORK
14,1 CM - 5 IN^{9/16}



231218
FOURCHETTE DE SERVICE
SERVING FORK
26,6 CM - 10 IN^{1/2}



231219
CUILLÈRE DE SERVICE
SERVING SPOON
26,6 CM - 10 IN^{1/2}



231221
PELLE À TARTE MONOBLOC
PASTRY SERVER SOLID HANDLE
25,2 CM - 9 IN^{5/16}



231220
LOUCHE
SOUP LADLE
29 CM - 11 IN^{7/16}

AQUATIC

Alldaydining

MADE IN FRANCE





239410
FOURCHETTE DE TABLE
 TABLE FORK
 20,1 CM - 7 IN^{15/16}



239411
COUTEAU DE TABLE
MANCHE ORFÈVRE LAME UNIE
 HOLLOW HANDLE TABLE KNIFE
 23,5 CM - 9 IN^{1/4}



239412
CUILLÈRE DE TABLE
 TABLE/PASTA SPOON
 20,3 CM - 8 IN



239416
CUILLÈRE À DESSERT
 DESSERT/SOUP SPOON, OVAL
 17,8 CM - 7 IN



239414
FOURCHETTE À DESSERT
 DESSERT/SALAD FORK
 17,7 CM - 6 IN^{5/16}



239415
COUTEAU À DESSERT
MANCHE ORFÈVRE LAME UNIE
 DESSERT KNIFE HOLLOW HANDLE
 21,1 CM - 8 IN^{5/16}



239418
FOURCHETTE À POISSON
 FISH FORK
 17,7 CM - 6 IN^{15/16}



239419
COUTEAU À POISSON/
GOURMET
 GOURMET FISH KNIFE
 20,1 CM - 7 IN^{15/16}



239413
CUILLÈRE À CAFÉ
 COFFEE/TEA SPOON
 13,7 CM - 5 IN^{3/8}



239417
CUILLÈRE À MOKA
 COFFEE/TEA SPOON
 11 CM - 4 IN^{5/16}

COUTURE

Alldaydining

MADE IN FRANCE





242668
FOURCHETTE DE TABLE
TABLE FORK
20,1 CM - 7 IN^{15/16}



242674
COUTEAU DE TABLE
MONOBLOC LAME SCIE
SOLID HANDLE TABLE KNIFE SERRATED
23,5 CM - 9 IN^{1/4}



242665
CUILLÈRE DE TABLE
TABLE/PASTA SPOON
20,3 CM - 8 IN



242689
CUILLÈRE À SOUPE ANGLAISE
BOUILLON SPOON, ROUND
17,9 CM - 7 IN^{1/16}



242677
CUILLÈRE À DESSERT
DESSERT/SOUP SPOON, OVAL
17,8 CM - 7 IN



242680
FOURCHETTE À DESSERT
DESSERT/SALAD FORK
17,7 CM - 6 IN^{5/16}



242683
COUTEAU À DESSERT
MONOBLOC LAME UNIE
DESSERT KNIFE SOLID HANDLE
20,7 CM - 8 IN^{1/8}



242705
COUTEAU À BEURRE MONOBLOC
BUTTER KNIFE SOLID HANDLE
18,9 CM - 7 IN^{7/16}



242671
CUILLÈRE À CAFÉ
COFFEE/TEA SPOON
13,7 CM - 5 IN^{3/8}



242686
CUILLÈRE À MOKA
COFFEE/TEA SPOON
11 CM - 4 IN^{5/16}

SUPERNATURE

Alldaydining

MADE IN FRANCE





163598
FOURCHETTE DE TABLE
TABLE FORK
20,2 CM - 7 IN^{15/16}



111970
COUTEAU DE TABLE
MONOBLOC LAME SCIE
TABLE KNIFE SOLID HANDLE SERRATED
23 CM - 9 IN^{7/16}



163597
CUILLÈRE DE TABLE
TABLE/PASTA SPOON
20,4 CM - 8 IN



163602
CUILLÈRE À DESSERT
DESSERT/SOUP SPOON, OVAL
18,5 CM - 7 IN^{1/4}



163603
FOURCHETTE À DESSERT
DESSERT/SALAD FORK
18,5 CM - 7 IN^{1/4}



111076
COUTEAU À DESSERT
MONOBLOC LAME UNIE
DESSERT KNIFE SOLID HANDLE
20,4 CM - 8 IN



181112
TARTINEUR
BUTTER SPREADER
16 CM - 6 IN^{5/16}



163599
CUILLÈRE À CAFÉ
COFFEE/TEA SPOON
14,1 CM - 5 IN^{9/16}

OVATION

Finedining

NEW





**235927
FOURCHETTE DE TABLE**

TABLE FORK
19,9 CM - 7 IN^{13/16}



**235930
COUTEAU DE TABLE
MONOBLOC LAME SCIE**

TABLE KNIFE SOLID HANDLE SERRATED
23,2 CM - 9 IN^{1/8}



**235928
CUILLÈRE DE TABLE**

TABLE/PASTA SPOON
19,9 CM - 7 IN^{13/16}



**235938
CUILLÈRE À SOUPE ANGLAISE**

BOUILLON SPOON, ROUND
18,4 CM - 7 IN^{1/4}



**235934
CUILLÈRE À DESSERT**

DESSERT/SOUP SPOON, OVAL
18,4 CM - 7 IN^{1/4}



**235933
FOURCHETTE À DESSERT**

DESSERT/SALAD FORK
18,4 CM - 7 IN^{1/4}



**235935
COUTEAU À DESSERT
MONOBLOC LAME SCIE**

DESSERT KNIFE SOLID HANDLE
SERRATED
20,9 CM - 8 IN^{3/16}



**235939
COUTEAU À BEURRE
MONOBLOC LAME UNIE**

BUTTER KNIFE SOLID HANDLE
16,5 CM - 6 IN^{1/2}



**235929
CUILLÈRE À CAFÉ**

COFFEE/TEA SPOON
13,9 CM - 5 IN^{1/2}



**235932
CUILLÈRE À MOKA**

DEMI TASSE SPOON
10,9 CM - 4 IN^{5/16}



**235937
FOURCHETTE À GÂTEAUX/
COCKTAIL**

PASTRY/COCKTAIL FORK
14,1 CM - 5 IN^{9/16}



**231218
FOURCHETTE DE SERVICE**

SERVING FORK
26,6 CM - 10 IN^{1/2}



**231219
CUILLÈRE DE SERVICE**

SERVING SPOON
26,6 CM - 10 IN^{1/2}



**231221
PELLE À TARTE MONOBLOC**

PASTRY SERVER SOLID HANDLE
25,2 CM - 9 IN^{15/16}



**231220
LOUCHE**

SOUP LADLE
29 CM - 11 IN^{7/16}

Possibilité de personnalisation
Bespoke options available



ONDE

Finedining





236968
FOURCHETTE DE TABLE
 TABLE FORK
 19,9 CM - 7 IN^{13/16}



239336
COUTEAU DE TABLE
MONOBLOC LAME SCIE
 TABLE KNIFE SOLID HANDLE SERRATED
 23,2 CM - 9 IN^{1/8}



236970
CUILLÈRE DE TABLE
 TABLE/PASTA SPOON
 19,9 CM - 7 IN^{13/16}



236976
CUILLÈRE À SOUPE ANGLAISE
 BOUILLON SPOON, ROUND
 18,4 CM - 7 IN^{1/4}



236971
CUILLÈRE À DESSERT
 DESSERT/SOUP SPOON, OVAL
 18,4 CM - 7 IN^{1/4}



236972
FOURCHETTE À DESSERT
 DESSERT/SALAD FORK
 18,4 CM - 7 IN^{1/4}



239337
COUTEAU À DESSERT
MONOBLOC LAME SCIE
 DESSERT KNIFE SOLID HANDLE
 SERRATED
 20,9 CM - 8 IN^{3/16}



236978
COUTEAU À BEURRE
MONOBLOC LAME UNIE
 BUTTER KNIFE SOLID HANDLE
 16,5 CM - 6 IN^{1/2}



236974
CUILLÈRE À CAFÉ
 COFFEE/TEA SPOON
 13,9 CM - 5 IN^{1/2}



236975
CUILLÈRE À MOKA
 DEMI TASSE SPOON
 10,9 CM - 4 IN^{3/16}



236977
FOURCHETTE À COCKTAIL/
ESCARGOTS
 SNAIL/COCKTAIL FORK
 14,1 CM - 5 IN^{9/16}



236981
FOURCHETTE DE SERVICE
 SERVING FORK
 26,6 CM - 10 IN^{1/2}



236982
CUILLÈRE DE SERVICE
 SERVING SPOON
 26,6 CM - 10 IN^{1/2}



237180
PELLE À TARTE MONOBLOC
 PASTRY SERVER SOLID HANDLE
 25,2 CM - 9 IN^{15/16}

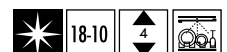

ONDE GOLD

Finedining





153998
FOURCHETTE DE TABLE
TABLE FORK
20,7 CM - 8 IN^{1/8}



154002
COUTEAU DE TABLE MONOBLOC LAME SCIE
TABLE KNIFE SOLID HANDLE SERRATED
23,5 CM - 9 IN^{1/4}



199761
COUTEAU À STEAK
STEAK TABLE
22,8 CM - 9 IN



153996
CUILLÈRE DE TABLE
TABLE/PASTA SPOON
20,7 CM - 8 IN^{7/8}



190015
CUILLÈRE À SOUPE ANGLAISE
BOUILLON SPOON, ROUND
18,3 CM - 7 IN^{3/16}



154571
CUILLÈRE À DESSERT
DESSERT/SOUP SPOON, OVAL
18,6 CM - 7 IN^{5/16}



154574
FOURCHETTE À DESSERT
DESSERT/SALAD FORK
18,6 CM - 7 IN^{5/16}



154555
COUTEAU À DESSERT MONOBLOC LAME SCIE
DESSERT KNIFE SOLID HANDLE SERRATED
21,1 CM - 8 IN^{5/16}



154580
COUTEAU À BEURRE MONOBLOC LAME UNIE
BUTTER KNIFE SOLID HANDLE
19,4 CM - 7 IN^{5/8}



154558
FOURCHETTE À POISSON
FISH FORK
18,6 CM - 7 IN^{5/16}



154561
COUTEAU À POISSON/ GOURMET
GOURMET FISH KNIFE
21,1 CM - 8 IN^{5/16}



154001
CUILLÈRE À CAFÉ
COFFEE/TEA SPOON
14,1 CM - 5 IN^{3/16}



154577
CUILLÈRE À MOKA
DEMI TASSE SPOON
11,1 CM - 4 IN^{3/8}



190016
CUILLÈRE À SODA
ICED TEA SPOON
19 CM - 7 IN^{1/2}



154547
FOURCHETTE À GÂTEAUX COCKTAIL
PASTRY/COCKTAIL FORK
13,9 CM - 5 IN^{1/2}



154563
FOURCHETTE DE SERVICE
SERVING FORK
26,6 CM - 10 IN^{1/2}



154562
CUILLÈRE DE SERVICE
SERVING SPOON
27 CM - 10 IN^{5/8}



154566
SERVICE À SALADE
SALAD SERVING SET
30 CM - 11 IN^{5/16}



154552
PELLE À TARTE MONOBLOC
PASTRY SERVER SOLID HANDLE
25,1 CM - 9 IN^{7/8}



154550
LOUCHE
SOUP LADLE
29,7 CM - 11 IN^{11/16}

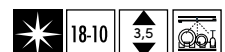

ASTRÉE CISELÉ

Alldaydining





226167
FOURCHETTE DE TABLE
 TABLE FORK
 21 CM - 8 IN^{1/4}



226176
COUTEAU DE TABLE
MONOBLOC LAME SCIE
 TABLE KNIFE SOLID HANDLE SERRATED
 22,8 CM - 9 IN



226168
CUILLÈRE DE TABLE
 TABLE/PASTA SPOON
 21 CM - 8 IN^{1/4}



226172
CUILLÈRE À DESSERT
 DESSERT/SOUP SPOON, OVAL
 18,9 CM - 7 IN^{7/16}



226171
FOURCHETTE À DESSERT
 DESSERT/SALAD FORK
 18,9 CM - 7 IN^{7/16}



226178
COUTEAU À DESSERT
MONOBLOC LAME UNIE
 DESSERT KNIFE SOLID HANDLE
 20,5 CM - 8 IN^{1/16}



226171
FOURCHETTE À POISSON
 FISH FORK
 18,9 CM - 7 IN^{7/16}



226169
CUILLÈRE À CAFÉ
 COFFEE/TEA SPOON
 14,5 CM - 5 IN^{11/16}



226170
CUILLÈRE À MOKA
 DEMI TASSE SPOON
 11,6 CM - 4 IN^{9/16}



226175
CUILLÈRE À SODA
 ICED TEA SPOON
 19 CM - 7 IN^{1/2}



226174
FOURCHETTE À GÂTEAUX/
COCKTAIL
 PASTRY/COCKTAIL FORK
 14,5 CM - 5 IN^{11/16}



181112
TARTINEUR
 BUTTER SPREADER
 16 CM - 6 IN^{5/16}

MIRAGE

Alldaydining

MADE IN FRANCE





111894
FOURCHETTE DE TABLE
 TABLE FORK
 20,4 CM - 8 IN^{1/16}



111921
COUTEAU DE TABLE
MONOBLOC LAME SCIE
 TABLE KNIFE SOLID HANDLE SERRATED
 23 CM - 9 IN^{1/16}



111891
CUILLÈRE DE TABLE
 TABLE/PASTA SPOON
 20,4 CM - 8 IN^{1/16}



111904
CUILLÈRE À DESSERT
 DESSERT/SOUP SPOON, OVAL
 18 CM - 7 IN^{1/16}



111907
FOURCHETTE À DESSERT
 DESSERT/SALAD FORK
 18 CM - 7 IN^{1/16}



210631
COUTEAU À DESSERT
MONOBLOC LAME SCIE
 DESSERT KNIFE SOLID HANDLE
 SERRATED
 20,3 CM - 8 IN



181112
TARTINEUR
 BUTTER SPREADER
 16 CM - 6 IN^{5/16}



111897
CUILLÈRE À CAFÉ
 COFFEE/TEA SPOON
 13,6 CM - 5 IN^{3/8}



114437
CUILLÈRE À MOKA
 DEMI TASSE SPOON
 11 CM - 4 IN^{5/16}

NORWAY

Alldaydining

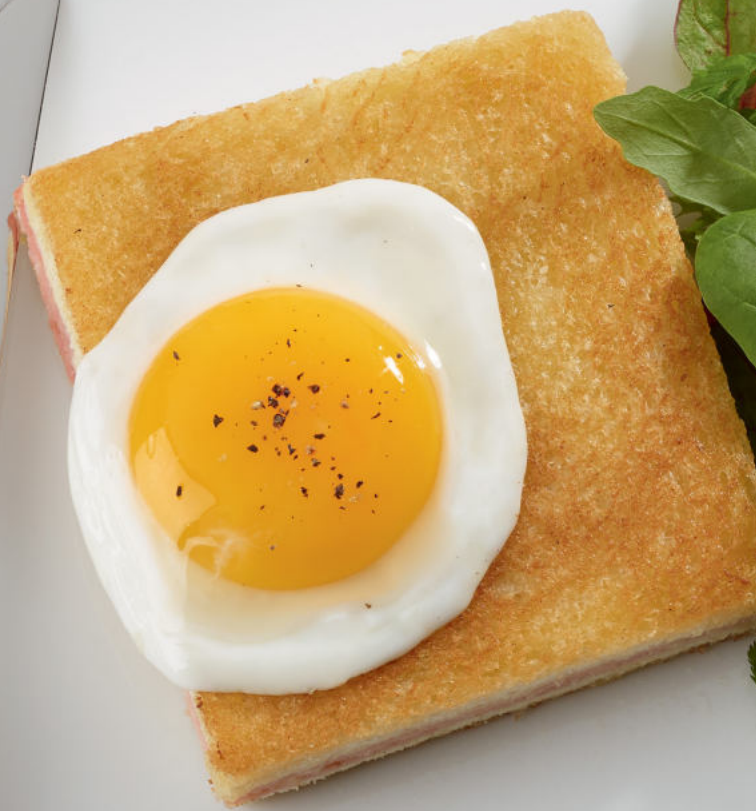





LES
COUVERTS
CLASSIQUES
CLASSICAL FLATWARE



126556
FOURCHETTE DE TABLE
TABLE FORK
20,2 CM - 7 IN^{15/16}



126559
CUILLÈRE À CAFÉ
COFFEE/TEA SPOON
13,9 CM - 5 IN^{1/2}



126565
COUTEAU DE TABLE
MANCHE ORFÈVRE LAME UNIE
TABLE KNIFE HOLLOW HANDLE
23 CM - 9 IN^{1/16}



155452
CUILLÈRE À MOKA
DEMI TASSE SPOON
11,1 CM - 4 IN^{3/8}



130332
COUTEAU DE TABLE
MANCHE ORFÈVRE LAME SCIE
TABLE KNIFE HOLLOW HANDLE SERRATED
23 CM - 9 IN^{1/16}



126591
FOURCHETTE DE SERVICE
SERVING FORK
24,8 CM - 9 IN^{3/4}



126553
CUILLÈRE DE TABLE
TABLE/PASTA SPOON
20,5 CM - 8 IN^{1/16}



126589
CUILLÈRE DE SERVICE
SERVING SPOON
25 CM - 9 IN^{13/16}



155528
CUILLÈRE À SOUPE ANGLAISE
BOUILLON SPOON, ROUND
17,5 CM - 6 IN^{7/8}



126587
PELLE À TARTE
MANCHE ORFÈVRE
PASTRY SERVER HOLLOW HANDLE
24 CM - 9 IN^{7/16}



126569
CUILLÈRE À DESSERT
DESSERT/SOUP SPOON, OVAL
18 CM - 7 IN^{1/16}



126572
FOURCHETTE À DESSERT
DESSERT/SALAD FORK
18 CM - 7 IN^{1/16}



126575
COUTEAU À DESSERT
MANCHE ORFÈVRE LAME UNIE
DESSERT KNIFE HOLLOW HANDLE
20,5 CM - 8 IN^{1/16}



154828
COUTEAU À BEURRE
MANCHE ORFÈVRE LAME UNIE
BUTTER KNIFE HOLLOW HANDLE
18,8 CM - 7 IN^{3/8}



126578
FOURCHETTE À POISSON
FISH FORK
18 CM - 7 IN^{1/16}



126581
COUTEAU À POISSON
FISH KNIFE
20,1 CM - 7 IN^{15/16}

ABSOLU

Finedining





232963
FOURCHETTE DE TABLE
 TABLE FORK
 20,3 CM - 8 IN



232966
COUTEAU DE TABLE
MONOBLOC LAME SCIE
 TABLE KNIFE SOLID HANDLE SERRATED
 24 CM - 9 IN^{7/16}



232964
CUILLÈRE DE TABLE
 TABLE/PASTA SPOON
 20,3 CM - 8 IN



234654
CUILLÈRE À SOUPE ANGLAISE
 BOUILLON SPOON
 17,6 CM - 6 IN^{15/16}



234659
CUILLÈRE À DESSERT
 DESSERT/SOUP SPOON, OVAL
 18,2 CM - 7 IN^{3/16}



234655
CUILLÈRE GOURMET
 GOURMET SPOON
 18,2 CM - 7 IN^{3/16}



234656
FOURCHETTE À DESSERT/POISSON
 DESSERT/SALAD/FISH FORK
 18,3 CM - 7 IN^{3/16}

234657
COUTEAU À POISSON/SPATULE GOURMET
MONOBLOC LAME UNIE
 FISH KNIFE/GOURMET SPATULA
 20,5 CM - 8 IN^{1/16}



234657
COUTEAU À DESSERT
MONOBLOC LAME UNIE
 DESSERT KNIFE SOLID HANDLE
 21,5 CM - 8 IN^{7/16}



234658
COUTEAU À BEURRE
MONOBLOC LAME UNIE
 BUTTER KNIFE SOLID HANDLE
 18,5 CM - 7 IN^{5/16}



232965
CUILLÈRE À CAFÉ
 COFFEE/TEA SPOON
 14 CM - 5 IN^{1/2}



234660
CUILLÈRE À MOKA
 DEMI TASSE SPOON
 11,1 CM - 4 IN^{3/8}



234661
FOURCHETTE À GÂTEAUX/COCKTAIL
 PASTRY/COCKTAIL FORK
 14 CM - 5 IN^{1/2}

Possibilité de personnalisation
 Bespoke options available



NORMANDY

Finedining

MADE IN FRANCE





126077
FOURCHETTE DE TABLE
TABLE FORK
20,8 CM - 8 IN^{3/16}



190643
COUTEAU DE TABLE
MONOBLOC LOURD
MANCHE DROIT LAME SCIE
TABLE KNIFE HEAVY SOLID HANDLE SERRATED
24,6 CM - 9 IN^{11/16}



130140
COUTEAU DE TABLE
MANCHE ORFÈVRE DROIT LAME SCIE
TABLE KNIFE HOLLOW HANDLE SERRATED
24,6 CM - 9 IN^{11/16}



127654
COUTEAU À STEAK
MANCHE ORFÈVRE DROIT LAME SCIE
STEAK KNIFE HOLLOW HANDLE SERRATED
23,9 CM - 9 IN^{7/16}



126074
CUILLÈRE DE TABLE
TABLE/PASTA SPOON
20,8 CM - 8 IN^{3/16}



126090
CUILLÈRE À DESSERT
DESSERT/SOUP SPOON, OVAL
18 CM - 7 IN^{1/16}



126093
FOURCHETTE À DESSERT
DESSERT/SALAD FORK
17,8 CM - 7 IN



190644
COUTEAU À DESSERT
MONOBLOC LOURD MANCHE
DROIT LAME SCIE
DESSERT KNIFE HEAVY SOLID HANDLE
SERRATED
20,5 CM - 8 IN^{1/16}



126096
COUTEAU À DESSERT
MANCHE ORFÈVRE LAME UNIE
DESSERT KNIFE HOLLOW HANDLE
20,5 CM - 8 IN^{1/16}



190417
COUTEAU À BEURRE
MONOBLOC LOURD MANCHE
DROIT LAME UNIE
BUTTER KNIFE HEAVY SOLID HANDLE
18,7 CM - 7 IN^{3/8}



129344
COUTEAU À BEURRE
MANCHE DROIT LAME UNIE
BUTTER KNIFE SOLID HANDLE
18,7 CM - 7 IN^{3/8}



126099
FOURCHETTE À POISSON
FISH FORK
17,7 CM - 6 IN^{5/16}



126102
COUTEAU À POISSON
FISH KNIFE
19,9 CM - 7 IN^{13/16}



126080
CUILLÈRE À CAFÉ
COFFEE/TEA SPOON
14 CM - 5 IN^{1/2}



126105
CUILLÈRE À MOKA
DEMI TASSE SPOON
11 CM - 4 IN^{5/16}



126108
FOURCHETTE À GÂTEAUX/COCKTAIL
PASTRY/COCKTAIL FORK
13,8 CM - 5 IN^{7/16}



190418
FOURCHETTE À HÛÎTRES
OYSTER FORK
13 CM - 5 IN^{1/8}

PIÈCES DE SERVICE
SERVING PIECES

VERLAINE
P. 140

FLORENCIA

Finedining

MADE IN FRANCE

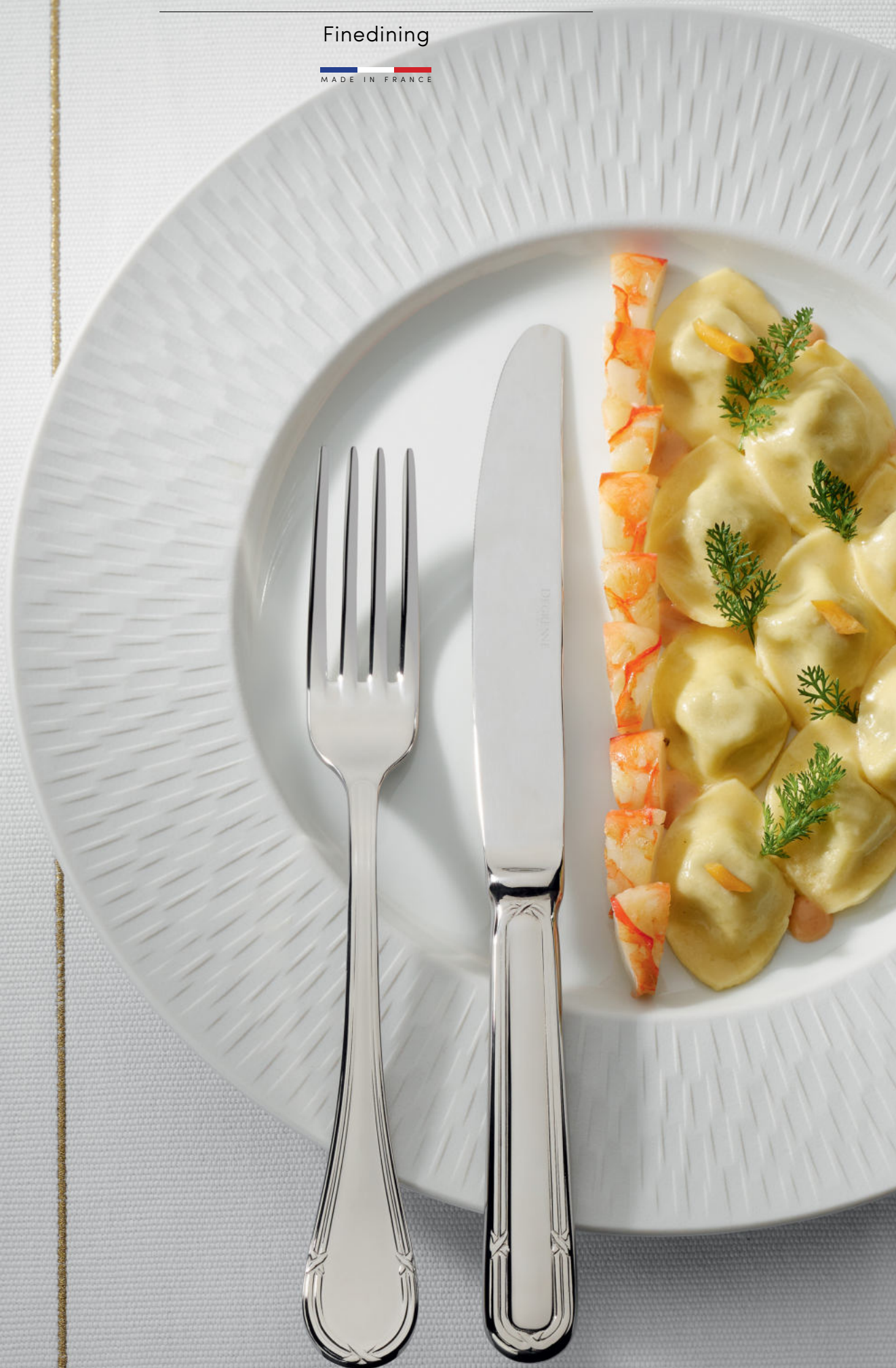



182968
FOURCHETTE DE TABLE
TABLE FORK
20,8 CM - 8 IN^{3/16}



182970
COUTEAU DE TABLE
MANCHE ORFÈVRE LAME SCIE
TABLE KNIFE HOLLOW HANDLE SERRATED
24,6 CM - 9 IN^{17/16}



186278
COUTEAU À STEAK
MANCHE ORFÈVRE LAME SCIE
STEAK KNIFE HOLLOW HANDLE SERRATED
23,9 CM - 9 IN^{7/16}



182967
CUILLÈRE DE TABLE
TABLE/PASTA SPOON
20,8 CM - 8 IN^{3/16}



186276
CUILLÈRE À SOUPE ANGLAISE
BOUILLON SPOON, ROUND
17,4 CM - 6 IN^{7/8}



182974
CUILLÈRE À DESSERT
DESSERT/SOUP SPOON, OVAL
18 CM - 7 IN^{1/16}



182975
FOURCHETTE À DESSERT
DESSERT/SALAD FORK
17,8 CM - 7 IN



182971
COUTEAU À DESSERT
MANCHE ORFÈVRE LAME UNIE
DESSERT KNIFE HOLLOW HANDLE
20,5 CM - 8 IN^{1/16}



186279
COUTEAU À BEURRE
MANCHE ORFÈVRE LAME UNIE
BUTTER KNIFE HOLLOW HANDLE
18,7 CM - 7 IN^{3/8}



182972
FOURCHETTE À POISSON
FISH FORK
17,7 CM - 6 IN^{15/16}



182973
COUTEAU À POISSON
FISH KNIFE
19,9 CM - 7 IN^{13/16}



182969
CUILLÈRE À CAFÉ
COFFEE/TEA SPOON
14 CM - 5 IN^{1/2}



182976
CUILLÈRE À MOKA
DEMI TASSE SPOON
11 CM - 4 IN^{5/16}



186274
FOURCHETTE À GÂTEAUX/
COCKTAIL
PASTRY/COCKTAIL FORK
13,8 CM - 5 IN^{7/16}



190681
FOURCHETTE À HÙÎTRES
OYSTER FORK
13 CM - 5 IN^{1/8}

PIÈCES DE SERVICE
SERVING PIECES

VERLAINE
P. 140

Possibilité de personnalisation
Bespoke options available

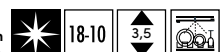

MARQUISE

Finedining

MADE IN FRANCE





127442
FOURCHETTE DE TABLE
TABLE FORK
20,8 CM - 8 IN^{3/16}



226580
COUTEAU À BEURRE
MONOBLOC LOURD
LAME UNIE
BUTTER KNIFE HEAVY SOLID HANDLE
19 CM - 7 IN^{1/2}



226578
COUTEAU DE TABLE
MONOBLOC LOURD LAME SCIE
TABLE KNIFE HEAVY SOLID HANDLE SERRATED
24,6 CM - 9 IN^{1/16}



122769
COUTEAU À BEURRE
MANCHE ORFÈVRE LAME UNIE
BUTTER KNIFE HOLLOW HANDLE
18,7 CM - 7 IN^{3/8}



139158
COUTEAU DE TABLE
MANCHE ORFÈVRE LAME SCIE
TABLE KNIFE HOLLOW HANDLE SERRATED
24,6 CM - 9 IN^{1/16}



127473
FOURCHETTE À POISSON
FISH FORK
17,7 CM - 6 IN^{15/16}



128841
COUTEAU À STEAK
MANCHE ORFÈVRE LAME SCIE
STEAK KNIFE HOLLOW HANDLE SERRATED
23,9 CM - 9 IN^{7/16}



127477
COUTEAU À POISSON
FISH KNIFE
19,9 CM - 7 IN^{13/16}



127439
CUILLÈRE DE TABLE
TABLE/PASTA SPOON
20,8 CM - 8 IN^{3/16}



130542
CUILLÈRE À SAUCE GOURMET
GOURMET/SAUCE SPOON
17,9 CM - 7 IN^{1/16}



127464
CUILLÈRE À DESSERT
DESSERT/SOUP SPOON, OVAL
18 CM - 7 IN^{1/16}



127455
CUILLÈRE À CAFÉ
COFFEE/TEA SPOON
14 CM - 5 IN^{1/2}



127467
FOURCHETTE À DESSERT
DESSERT/SALAD FORK
17,8 CM - 7 IN



127479
CUILLÈRE À MOKA
DEMI TASSE SPOON
11 CM - 4 IN^{5/16}



226579
COUTEAU À DESSERT
MONOBLOC LOURD LAME UNIE
DESSERT KNIFE HEAVY SOLID HANDLE
21,1 CM - 8 IN^{5/16}



127482
FOURCHETTE À GÂTEAUX/
COCKTAIL
PASTRY/COCKTAIL FORK
13,8 CM - 5 IN^{7/16}



127470
COUTEAU À DESSERT
MANCHE ORFÈVRE LAME UNIE
DESSERT KNIFE HOLLOW HANDLE
20,5 CM - 8 IN^{1/16}



130266
FOURCHETTE À HUÎTRES
OYSTER FORK
13 CM - 5 IN^{1/8}

PIÈCES DE SERVICE
SERVING PIECES

VERLAINE
P. 140

MILADY

Finedining

MADE IN FRANCE





105278
FOURCHETTE DE TABLE
 TABLE FORK
 20,8 CM - 8 IN^{3/16}



105274
COUTEAU DE TABLE
MANCHE ORFÈVRE LAME SCIE
 TABLE KNIFE HOLLOW HANDLE SERRATED
 24,6 CM - 9 IN^{11/16}



105310
CUILLÈRE DE TABLE
 TABLE/PASTA SPOON
 20,8 CM - 8 IN^{3/16}



105294
CUILLÈRE À DESSERT
 DESSERT/SOUP SPOON, OVAL
 CUCHARA DE POSTRE
 18 CM - 7 IN^{1/16}



105290
FOURCHETTE À DESSERT
 DESSERT/SALAD FORK
 17,8 CM - 7 IN



105305
COUTEAU À DESSERT
MANCHE ORFÈVRE LAME UNIE
 DESSERT KNIFE HOLLOW HANDLE
 20,5 CM - 8 IN^{1/16}



105303
CUILLÈRE À CAFÉ
 COFFEE/TEA SPOON
 14 CM - 5 IN^{1/2}



105293
CUILLÈRE À MOKA
 DEMI TASSE SPOON
 11 CM - 4 IN^{5/16}

PIÈCES DE SERVICE
 SERVING PIECES

VERLAINE
P. 140

NEUILLY

Finedining

MADE IN FRANCE





105831
FOURCHETTE DE TABLE
TABLE FORK
20,8 CM - 8 IN^{3/16}



182460
COUTEAU DE TABLE
MONOBLOC LOURD LAME SCIE
TABLE KNIFE HEAVY SOLID HANDLE
SERRATED
24,6 CM - 9 IN^{11/16}



105886
COUTEAU DE TABLE
MANCHE ORFÈVRE DROIT LAME UNIE
TABLE KNIFE HOLLOW HANDLE
24,6 CM - 9 IN^{11/16}



105860
COUTEAU DE TABLE
MANCHE ORFÈVRE DROIT LAME SCIE
TABLE KNIFE HOLLOW HANDLE SERRATED
24,6 CM - 9 IN^{11/16}



105801
COUTEAU À STEAK
MANCHE ORFÈVRE LAME SCIE
STEAK KNIFE HOLLOW HANDLE SERRATED
23,9 CM - 9 IN^{7/16}



105798
CUILLÈRE DE TABLE
TABLE/PASTA SPOON
20,8 CM - 8 IN^{3/16}



105908
CUILLÈRE À SOUPE ANGLAISE
BOUILLON SPOON, ROUND
17,2 CM - 6 IN^{3/4}



105861
CUILLÈRE À DESSERT
DESSERT/SOUP SPOON, OVAL
18 CM - 7 IN^{1/16}



105885
FOURCHETTE À DESSERT
DESSERT/SALAD FORK
17,8 CM - 7 IN



182463
COUTEAU À DESSERT
MONOBLOC LOURD LAME UNIE
DESSERT KNIFE HEAVY SOLID HANDLE
21,1 CM - 8 IN^{5/16}



105832
COUTEAU À DESSERT
MANCHE ORFÈVRE
LAME UNIE
DESSERT KNIFE HOLLOW HANDLE
20,5 CM - 8 IN^{1/16}



190420
COUTEAU À BEURRE
MONOBLOC LOURD
LAME UNIE
BUTTER KNIFE HEAVY SOLID HANDLE
19 CM - 7 IN^{1/2}



003332
COUTEAU À BEURRE
MANCHE ORFÈVRE
LAME UNIE
BUTTER KNIFE HOLLOW HANDLE
18,7 CM - 7 IN^{3/8}



105888
FOURCHETTE À POISSON
FISH FORK
17,8 CM - 7 IN



105797
COUTEAU À POISSON
FISH KNIFE
19,7 CM - 7 IN^{3/4}



105910
CUILLÈRE À SAUCE GOURMET
GOURMET/SAUCE SPOON
17,9 CM - 7 IN^{11/16}



105833
CUILLÈRE À CAFÉ
COFFEE/TEA SPOON
14 CM - 5 IN^{1/2}



109471
CUILLÈRE À MOKA
DEMI TASSE SPOON
11 CM - 4 IN^{5/16}



105800
CUILLÈRE À SODA
ICED TEA SPOON
18,2 CM - 7 IN^{3/16}



105795
FOURCHETTE À GÂTEAUX/
COCKTAIL
PASTRY/COCKTAIL FORK
13,8 CM - 5 IN^{7/16}



105907
FOURCHETTE À HUÎTRES
OYSTER FORK
12,9 CM - 5 IN^{11/16}



132782
FOURCHETTE À ESCARGOTS
SNAIL FORK
13,5 CM - 5 IN^{5/16}



003390
COUTEAU À FROMAGES
MANCHE ORFÈVRE LAME UNIE
CHEESE KNIFE HOLLOW HANDLE
19,3 CM - 7 IN^{5/8}



002185
FOURCHETTE DE SERVICE
SERVING FORK
24,8 CM - 9 IN^{3/4}



002186
CUILLÈRE DE SERVICE
SERVING SPOON
25 CM - 9 IN^{13/16}



040646
SERVICE À SALADE
SALADE SERVING SET
25,8 CM - 10 IN^{3/16}



083340
PELLE À TARTE MONOBLOC
PASTRY SERVER SOLID HANDLE
24,9 CM - 9 IN^{13/16}



097717
LOUCHE
SOUP LADLE
29,8 CM - 11 IN^{3/4}



002179
LOUCHE À SAUCE
SAUCE LADLE
15,7 CM - 6 IN^{3/16}

Possibilité de personnalisation
Bespoke options available

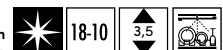

VERLAINE

Finedining

MADE IN FRANCE





105021
FOURCHETTE DE TABLE
TABLE FORK
20,9 CM - 8 IN^{3/16}



190415
COUTEAU DE TABLE
MONOBLOC LOURD LAME SCIE
TABLE KNIFE HEAVY SOLID HANDLE SERRATED
24,8 CM - 9 IN^{3/4}



105006
COUTEAU DE TABLE
MANCHE ORFÈVRE LAME SCIE
TABLE KNIFE HOLLOW HANDLE SERRATED
24,7 CM - 9 IN^{3/4}



122746
COUTEAU À STEAK
MANCHE ORFÈVRE LAME SCIE
STEAK KNIFE HOLLOW HANDLE SERRATED
23,8 CM - 9 IN^{3/8}



104988
CUILLÈRE DE TABLE
TABLE/PASTA SPOON
21,1 CM - 8 IN^{5/16}



104985
CUILLÈRE À DESSERT
DESSERT/SOUP SPOON, OVAL
18 CM - 7 IN^{1/16}



105013
FOURCHETTE À DESSERT
DESSERT/SALAD FORK
17,9 CM - 7 IN^{1/16}



190416
COUTEAU À DESSERT
MONOBLOC LOURD LAME UNIE
DESSERT KNIFE HEAVY SOLID HANDLE
21,3 CM - 8 IN^{3/8}



104989
COUTEAU À DESSERT
MANCHE ORFÈVRE LAME UNIE
DESSERT KNIFE HOLLOW HANDLE
20,6 CM - 8 IN^{1/8}



190414
COUTEAU À BEURRE
MONOBLOC LOURD
LAME UNIE
BUTTER KNIFE HEAVY SOLID HANDLE
19,7 CM - 7 IN^{3/4}



016394
COUTEAU À BEURRE
MANCHE ORFÈVRE LAME UNIE
BUTTER KNIFE HOLLOW HANDLE
18,9 CM - 7 IN^{7/16}



104994
FOURCHETTE À POISSON
FISH FORK
17,9 CM - 7 IN^{1/16}



104995
COUTEAU À POISSON
FISH KNIFE
20 CM - 7 IN^{7/8}



104986
CUILLÈRE À CAFÉ
COFFEE/TEA SPOON
14,1 CM - 5 IN^{9/16}



104993
CUILLÈRE À MOKA
DEMI TASSE SPOON
11,2 CM - 4 IN^{7/16}



105012
FOURCHETTE À GÂTEAUX/
COCKTAIL
PASTRY/COCKTAIL FORK
13,9 CM - 5 IN^{1/2}

LUTÈCE

Finedining

MADE IN FRANCE





104485
FOURCHETTE DE TABLE
 TABLE FORK
 20,8 CM - 8 IN^{3/16}



182466
COUTEAU DE TABLE
MONOBLOC LOURD LAME SCIE
 TABLE KNIFE HEAVY SOLID HANDLE
 SERRATED
 24,6 CM - 9 IN^{1/16}



161390
COUTEAU DE TABLE
MANCHE ORFÈVRE DROIT LAME UNIE
 TABLE KNIFE HOLLOW HANDLE
 24,6 CM - 9 IN^{1/16}



161391
COUTEAU DE TABLE
MANCHE ORFÈVRE LAME SCIE
 TABLE KNIFE HOLLOW HANDLE SERRATED
 24,6 CM - 9 IN^{1/16}



122759
COUTEAU À STEAK
MANCHE ORFÈVRE LAME SCIE
 STEAK KNIFE HOLLOW HANDLE SERRATED
 23,9 CM - 9 IN^{7/16}



104526
CUILLÈRE DE TABLE
 TABLE/PASTA SPOON
 20,8 CM - 8 IN^{3/16}



104448
CUILLÈRE À SOUPE ANGLAISE
 BOUILLON SPOON, ROUND
 17,2 CM - 6 IN^{3/4}



104484
CUILLÈRE À DESSERT
 DESSERT/SOUP SPOON, OVAL
 18 CM - 7 IN^{1/16}



104543
FOURCHETTE À DESSERT
 DESSERT/SALAD FORK
 17,8 CM - 7 IN



182467
COUTEAU À DESSERT
MONOBLOC LOURD LAME UNIE
 DESSERT KNIFE HEAVY SOLID HANDLE
 20,5 CM - 8 IN^{1/16}



161394
COUTEAU À DESSERT
MANCHE ORFÈVRE LAME UNIE
 DESSERT KNIFE HOLLOW HANDLE
 20,5 CM - 8 IN^{1/16}



190419
COUTEAU À BEURRE
MONOBLOC LOURD LAME UNIE
 BUTTER KNIFE HEAVY SOLID HANDLE
 18,7 CM - 7 IN^{3/8}



122760
COUTEAU À BEURRE
MANCHE ORFÈVRE LAME UNIE
 BUTTER KNIFE HOLLOW HANDLE
 18,7 CM - 7 IN^{3/8}

BLOIS

Finedining

MADE IN FRANCE





104507
FOURCHETTE POISSON
FISH FORK
17,8 CM - 7 IN



104508
COUTEAU POISSON
FISH KNIFE
19,7 CM - 7 IN^{3/4}



145451
CUILLÈRE À SAUCE GOURMET
GOURMET/SAUCE SPOON
17,9 CM - 7 IN^{7/16}



104561
CUILLÈRE À CAFÉ
COFFEE/TEA SPOON
14 CM - 5 IN^{1/2}



109465
CUILLÈRE À MOKA
DEMI TASSE SPOON
11 CM - 4 IN^{5/16}



124259
CUILLÈRE À SODA
ICED TEA SPOON
18,2 CM - 7 IN^{3/16}



104480
**FOURCHETTE À GÂTEAUX/
COCKTAIL**
PASTRY/COCKTAIL FORK
13,8 CM - 5 IN^{7/16}



104463
FOURCHETTE À HUITRES
OYSTER FORK
12,9 CM - 5 IN^{1/16}



189208
COUTEAU À FROMAGE
MANCHE ORFÈVRE LAME UNIE
CHEESE KNIFE HOLLOW HANDLE
19,3 CM - 7 IN^{5/8}



195757
FOURCHETTE DE SERVICE
SERVING FORK
24,8 CM - 9 IN^{3/4}



195755
CUILLÈRE DE SERVICE
SERVING SPOON
25 CM - 9 IN^{13/16}



195757
FOURCHETTE À DÉCOUPER
CARVING FORK
24,8 CM - 9 IN^{3/4}



189511
COUTEAU À DÉCOUPER
MANCHE ORFÈVRE LAME UNIE
CARVING KNIFE HOLLOW HANDLE
28,7 CM - 11 IN^{5/16}



195750
SERVICE À SALADE
SALADE SERVING SET
25,7 CM - 10 IN^{1/8}



195753
PELLE À TARTE MONOBLOC
PASTRY SERVER SOLID HANDLE
24,9 CM - 9 IN^{13/16}



195762
LOUCHE
SOUP LADLE
29,8 CM - 11 IN^{3/4}



195759
LOUCHE À SAUCE
SAUCE LADLE
15,7 CM - 6 IN^{3/16}

BLOIS

Finedining

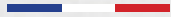
MADE IN FRANCE





241290
FOURCHETTE DE TABLE
 TABLE FORK
 20,8 CM - 8 IN^{3/16}



241296
COUTEAU DE TABLE
MONOBLOC LAME SCIE
 TABLE KNIFE SOLID HANDLE SERRATED
 24,6 CM - 9 IN^{11/16}



241287
CUILLÈRE DE TABLE
 TABLE/PASTA SPOON
 20,8 CM - 8 IN^{3/16}



243296
CUILLÈRE À SOUPE ANGLAISE
 BOUILLON SPOON, ROUND
 17,2 CM - 6 IN^{3/4}



243294
CUILLÈRE À DESSERT
 DESSERT/SOUP SPOON, OVAL
 18 CM - 7 IN^{7/16}



243293
FOURCHETTE À DESSERT
 DESSERT/SALAD FORK
 17,8 CM - 7 IN



243295
COUTEAU À DESSERT
MONOBLOC LAME UNIE
 DESSERT KNIFE SOLID HANDLE
 20,5 CM - 8 IN^{7/16}



243299
COUTEAU À BEURRE
MONOBLOC LAME UNIE
 BUTTER KNIFE SOLID HANDLE
 18,7 CM - 7 IN^{3/8}



243297
FOURCHETTE POISSON
 FISH FORK
 17,7 CM - 6 IN^{15/16}



243298
COUTEAU POISSON
 FISH KNIFE
 19,9 CM - 7 IN^{13/16}



241293
CUILLÈRE À CAFÉ
 COFFEE/TEA SPOON
 14 CM - 5 IN^{1/2}



243301
FOURCHETTE DE SERVICE
 SERVING FORK
 24,8 CM - 9 IN^{3/4}



243300
CUILLÈRE DE SERVICE
 SERVING SPOON
 25 CM - 9 IN^{13/16}



BLOIS CONTRASTE

Finedining

MADE IN FRANCE





141089
FOURCHETTE DE TABLE
TABLE FORK
20,3 CM - 8 IN



103550
CUILLÈRE À CAFÉ
COFFEE/TEA SPOON
13,5 CM - 5 IN^{5/16}



113017
COUTEAU DE TABLE
MONOBLOC LOURD
LAME SCIE
TABLE KNIFE HEAVY SOLID HANDLE
SERRATED
24,4 CM - 9 IN^{5/8}



109465
CUILLÈRE À MOKA
DEMI TASSE SPOON
11 CM - 4 IN^{5/16}



160427
COUTEAU À STEAK
MONOBLOC LAME SCIE
STEAK KNIFE SOLID HANDLE
SERRATED
23,2 CM - 9 IN^{1/8}



124259
CUILLÈRE À SODA
ICED TEA SPOON
18,2 CM - 7 IN^{3/16}



141086
CUILLÈRE DE TABLE
TABLE/PASTA SPOON
20,4 CM - 8 IN^{1/16}



104480
FOURCHETTE À GÂTEAUX/
COCKTAIL
PASTRY/COCKTAIL FORK
15 CM - 5 IN^{7/8}



104448
CUILLÈRE À SOUPE ANGLAISE
BOUILLON SPOON, ROUND
17,2 CM - 6 IN^{3/4}



104463
FOURCHETTE À HÙITRES
OYSTER FORK
12,9 CM - 5 IN^{1/16}



108236
CUILLÈRE À DESSERT
DESSERT/SOUP SPOON, OVAL
17,9 CM - 7 IN^{1/16}



195757
FOURCHETTE DE SERVICE
SERVING FORK
24,8 CM - 9 IN^{3/4}



108238
FOURCHETTE À DESSERT
DESSERT/SALAD FORK
17,8 CM - 7 IN



195755
CUILLÈRE DE SERVICE
SERVING SPOON
25 CM - 9 IN^{13/16}



113019
COUTEAU À DESSERT
MONOBLOC LOURD
LAME UNIE
DESSERT KNIFE HEAVY SOLID HANDLE
21 CM - 8 IN^{1/4}



195750
SERVICE À SALADE
SALAD SERVING SET
25,7 CM - 10 IN^{1/8}



189971
COUTEAU À BEURRE
MONOBLOC LAME UNIE
BUTTER KNIFE SOLID HANDLE
18,9 CM - 7 IN^{7/16}



195753
PELLE À TARTE MONOBLOC
PASTRY SERVER SOLID HANDLE
24,9 CM - 9 IN^{13/16}



104507
FOURCHETTE POISSON
FISH FORK
17,8 CM - 7 IN



195762
LOUCHE
SOUP LADLE
29,8 CM - 11 IN^{3/4}



104508
COUTEAU POISSON
FISH KNIFE
19,7 CM - 7 IN^{3/4}



195759
LOUCHE À SAUCE
SAUCE LADLE
15,7 CM - 6 IN^{3/16}

MIKADO

Alldaydining





230285
FOURCHETTE DE TABLE
 TABLE FORK
 20,3 CM - 8 IN



230287
COUTEAU DE TABLE
MONOBLOC LOURD LAME SCIE
 TABLE KNIFE HEAVY SOLID HANDLE SERRATED
 24,4 CM - 9 IN^{5/8}



230293
COUTEAU À STEAK
MONOBLOC LAME SCIE
 STEAK KNIFE SOLID HANDLE SERRATED
 23,2 CM - 9 IN^{7/8}



230286
CUILLÈRE DE TABLE
 TABLE/PASTA SPOON
 20,4 CM - 8 IN^{1/16}



230291
CUILLÈRE À DESSERT
 DESSERT/SOUP SPOON, OVAL
 17,9 CM - 7 IN^{1/16}



230290
FOURCHETTE À DESSERT
 DESSERT/SALAD FORK
 17,8 CM - 7 IN



230292
COUTEAU À DESSERT
MONOBLOC LOURD LAME UNIE
 DESSERT KNIFE HEAVY SOLID HANDLE
 21 CM - 8 IN^{1/4}



230288
CUILLÈRE À CAFÉ
 COFFEE/TEA SPOON
 13,5 CM - 5 IN^{5/16}



230289
CUILLÈRE À MOKA
 DEMI TASSE SPOON
 11 CM - 4 IN^{5/16}

MIKADO VINTAGE

Alldaydining





141094
FOURCHETTE DE TABLE
TABLE FORK
20,3 CM - 8 IN



103857
COUTEAU DE TABLE MONOBLOC LAME SCIE
TABLE KNIFE SOLID HANDLE SERRATED
23,7 CM - 9 IN^{5/16}



160433
COUTEAU À STEAK MONOBLOC LAME SCIE
STEAK KNIFE SOLID HANDLE SERRATED
23,6 CM - 9 IN^{5/16}



141092
CUILLÈRE DE TABLE
TABLE/PASTA SPOON
20,4 CM - 8 IN^{1/16}



105908
CUILLÈRE À SOUPE ANGLAISE
BOUILLON SPOON, ROUND
17,2 CM - 6 IN^{3/4}



108232
CUILLÈRE À DESSERT
DESSERT/SOUP SPOON, OVAL
17,9 CM - 7 IN^{1/16}



108234
FOURCHETTE À DESSERT
DESSERT/SALAD FORK
17,8 CM - 7 IN



210628
COUTEAU À DESSERT MONOBLOC LAME SCIE
DESSERT KNIFE SOLID HANDLE
20,6 CM - 8 IN^{1/8}



103564
CUILLÈRE À CAFÉ
COFFEE/TEA SPOON
13,5 CM - 5 IN^{5/16}



109471
CUILLÈRE À MOKA
DEMI TASSE SPOON
11 CM - 4 IN^{1/16}



105800
CUILLÈRE À SODA
ICED TEA SPOON
18,2 CM - 7 IN^{3/16}



132782
FOURCHETTE À ESCARGOTS
SNAIL FORK
13,5 CM - 5 IN^{5/16}



002185
FOURCHETTE DE SERVICE
SERVING FORK
24,8 CM - 9 IN^{3/4}



002186
CUILLÈRE DE SERVICE
SERVING SPOON
25 CM - 9 IN^{13/16}



040646
SERVICE À SALADE
SALAD SERVING SET
25,8 CM - 10 IN^{3/16}



083340
PELLE À TARTE MONOBLOC
PASTRY SERVER SOLID HANDLE
24,9 CM - 9 IN^{13/16}



097717
LOUCHE
SOUP LADLE
29,8 CM - 11 IN^{3/4}



002179
LOUCHE À SAUCE
SAUCE LADLE
15,7 CM - 6 IN^{3/16}

CONFIDENCE

Alldaydining





105804
FOURCHETTE DE TABLE
TABLE FORK
21 CM - 8 IN^{1/4}



105892
COUTEAU DE TABLE
MONOBLOC LAME SCIE
TABLE KNIFE SOLID HANDLE
SERRATED
25 CM - 9 IN^{13/16}



160424
COUTEAU À STEAK
MONOBLOC LAME SCIE
STEAK KNIFE SOLID HANDLE SERRATED
23,2 CM - 9 IN^{1/8}



105911
CUILLÈRE DE TABLE
TABLE/PASTA SPOON
21 CM - 8 IN^{1/4}



105863
CUILLÈRE À DESSERT
DESSERT/SOUP SPOON, OVAL
18 CM - 7 IN^{1/16}



105890
FOURCHETTE À DESSERT
DESSERT/SALAD FORK
18 CM - 7 IN^{1/16}



210626
COUTEAU À DESSERT
MONOBLOC LAME SCIE
DESSERT KNIFE SOLID HANDLE SERRATED
20,7 CM - 8 IN^{1/8}



105837
FOURCHETTE À POISSON
FISH FORK
18 CM - 7 IN^{1/16}



105912
COUTEAU À POISSON
FISH KNIFE
20 CM - 7 IN^{7/8}



105838
CUILLÈRE À CAFÉ
COFFEE/TEA SPOON
14,1 CM - 5 IN^{9/16}



105891
CUILLÈRE À MOKA
DEMI TASSE SPOON
11 CM - 4 IN^{9/16}



105805
FOURCHETTE À GÂTEAUX/
COCKTAIL
PASTRY/COCKTAIL FORK
13,9 CM - 5 IN^{1/2}



105803
FOURCHETTE À HÙÎTRES
OYSTER FORK
13,2 CM - 5 IN^{3/16}



000490
FOURCHETTE DE SERVICE
SERVING FORK
24,6 CM - 9 IN^{11/16}



000491
CUILLÈRE DE SERVICE
SERVING SPOON
24,9 CM - 9 IN^{12/16}

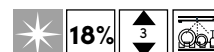

VIEUX PARIS

Alldaydining



MIRAGE LES ESSENCES



243524
COUTEAU À STEAK MANCHE OLIVIER
STEAK KNIFE OLIVE WOOD HANDLE
23 CM - 9 IN^{1/16}



243528
COUTEAU À STEAK MANCHE PICANA
STEAK KNIFE PICANA HANDLE
23 CM - 9 IN^{1/16}



243525
COUTEAU À STEAK MANCHE ÉBÈNE
STEAK KNIFE EBONY HANDLE
23 CM - 9 IN^{1/16}

MIRAGE



226261
COUTEAU DE TABLE/ STEAK LAME UNIE ANTHRACITE
BLACK TABLE STEAK KNIFE
23 CM - 9 IN^{1/16}



226263
COUTEAU DE TABLE/ STEAK LAME UNIE BLANC
WHITE TABLE STEAK KNIFE
23 CM - 9 IN^{1/16}

COUTEAUX STEAK

Alldaydining

MADE IN FRANCE



COUTEAUX STEAK

Alldaydining

MIROIR - MIRROR



199761
COUTEAU À STEAK MONOBLOC LAME SCIE ASTREE CISELE
ASTREE CISELÉ STEAK KNIFE SERRATED
22,8 CM - 9 IN



122759
COUTEAU À STEAK MANCHE ORFEVRE LAME SCIE BLOIS  **MADE IN FRANCE**
BLOIS STEAK KNIFE HOLLOW HANDLE SERRATED
23,9 CM - 9 IN^{7/16}



160433
COUTEAU À STEAK MONOBLOC LAME SCIE CONFIDENCE
CONFIDENCE STEAK KNIFE SOLID HANDLE SERRATED
23,6 CM - 9 IN^{5/16}



159451
COUTEAU À STEAK MONOBLOC LAME SCIE GOURMET
GOURMET STEAK KNIFE SOLID HANDLE SERRATED
23,5 CM - 9 IN^{1/4}



197521
COUTEAU À STEAK MONOBLOC LAME SCIE GUEST  **MADE IN FRANCE**
GUEST STEAK KNIFE SOLID HANDLE SERRATED
23,2 CM - 9 IN^{7/8}



203017
COUTEAU À STEAK MONOBLOC LAME SCIE GUEST STAR  **MADE IN FRANCE**
GUEST STAR STEAK KNIFE SOLID HANDLE SERRATED
23,2 CM - 9 IN^{1/8}



230339
COUTEAU À STEAK MONOBLOC LAME SCIE GUEST VINTAGE
GUEST VINTAGE STEAK KNIFE SOLID HANDLE SERRATED
23,2 CM - 9 IN^{7/8}



230293
COUTEAU À STEAK MONOBLOC LAME SCIE MIKADO VINTAGE
MIKADO VINTAGE STEAK KNIFE SOLID HANDLE SERRATED
23,2 CM - 9 IN^{7/8}



105801
COUTEAU À STEAK MANCHE ORFEVRE LAME SCIE VERLAINE  **MADE IN FRANCE**
VERLAINE STEAK KNIFE HOLLOW HANDLE SERRATED
23,9 CM - 9 IN^{7/16}



160424
COUTEAU À STEAK MANCHE DROIT LAME CRANTEE VIEUX PARIS  **MADE IN FRANCE**
VIEUX PARIS STEAK KNIFE SERRATED
23,2 CM - 9 IN^{1/8}



181107
COUTEAU À STEAK MONOBLOC LAME UNIE XY  **MADE IN FRANCE**
XY STEAK KNIFE SOLID HANDLE
23,3 CM - 9 IN^{3/16}

LE PHIL

Finedining

MADE IN FRANCE

NEW





*** 207257**
FOURCHETTE À DESSERT
DESSERT/SALAD FORK
16,5 CM - 6 IN^{1/2}



*** 207259**
COUTEAU À DESSERT
MONOBLOC LAME UNIE
DESSERT KNIFE SOLID HANDLE
17,7 CM - 6 IN^{15/16}



*** 207258**
CUILLÈRE À DESSERT
DESSERT/SOUP SPOON, OVAL
16,5 CM - 6 IN^{1/2}



*** 207256**
CUILLÈRE À CAFÉ
COFFEE/TEA SPOON
13,2 CM - 5 IN^{3/16}

PETIT GOURMET

Alldaydining





190018
CUILLÈRE À SODA
ICED TEA SPOON
19 CM - 7 IN^{1/2}



189973
CUILLÈRE À SODA
ICED TEA SPOON
19 CM - 7 IN^{1/2}



226175
CUILLÈRE À SODA
ICED TEA SPOON
19 CM - 7 IN^{1/2}



162724
CUILLÈRE À AGRUMES
CITRUS FRUITS SPOON
15,3 CM - 6 IN



190424
FOURCHETTE À HUÎTRES
OYSTER FORK
14,1 CM - 5 IN^{3/16}



189974
FOURCHETTE À HUÎTRES
OYSTER FORK
14,1 CM - 5 IN^{3/16}



162728
FOURCHETTE/PIQUE À ESCARGOTS/COCKTAIL
COCKTAIL, SNAIL FORK
10,8 CM - 4 IN^{1/4}



162730
CURETTE À CRUSTACÉS
SEAFOOD SCRAPER
19,1 CM - 7 IN^{1/2}



189971
COUTEAU À BEURRE MONOBLOC LAME UNIE
BUTTER KNIFE SOLID HANDLE
18,9 CM - 7 IN^{7/16}



159451
COUTEAU À STEAK MONOBLOC LAME SCIE
STEAK KNIFE SOLID HANDLE SERRATED
23,5 CM - 9 IN^{1/4}



181112
TARTINEUR
BUTTER SPREADER
16 CM - 6 IN^{5/16}



197522
FOURCHETTE DE SERVICE
SERVING FORK
26,6 CM - 10 IN^{1/2}



197523
CUILLÈRE DE SERVICE
SERVING SPOON
27 CM - 10 IN^{5/16}



197525
SERVICE À SALADE
SALAD SERVING SET
30 CM - 11 IN^{13/16}



197527
PELLE À TARTE MONOBLOC
PASTRY SERVER SOLID HANDLE
25,1 CM - 9 IN^{7/8}



153193
LOUCHE
SOUP LADLE
28,8 CM - 11 IN^{5/16}



154606
CUILLÈRE À SAUCE
SAUCE LADLE
18,5 CM - 7 IN^{5/16}



184492
PINCE À CRUSTACÉ
SEAFOOD CRACKER
16,5 CM - 6 IN^{1/2}

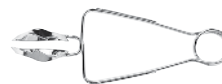

004013
PINCE À ESCARGOTS
SNAIL TONG
16 CM - 6 IN^{5/16}



204498
PINCE À PAIN
BREAD TONG
23 CM - 9 IN^{1/16}



204496
CISEAUX À GÂTEAUX
PASTRY CISSORS/TONG
20 CM - 7 IN^{7/8}



204499
PINCE À SERVIR
SERVING TONG
29,5 CM - 11 IN^{5/16}

PIÈCES COMPLÉMENTAIRES

Alldaydining

VERLAINE



**105795
FOURCHETTE À GÂTEAUX/
COCKTAIL**
PASTRY/COCKTAIL FORK
13,8 CM - 5 IN^{7/16}



**105907
FOURCHETTE
À HUITRES**
OYSTER FORK
12,9 CM - 5 IN^{1/16}



**132782
FOURCHETTE
À ESCARGOTS**
SNAIL FORK



**002185
FOURCHETTE
DE SERVICE**
SERVING FORK
24,8 CM - 9 IN^{3/4}



**002186
CUILLÈRE
DE SERVICE**
SERVING SPOON
25 CM - 9 IN^{13/16}



**040646
SERVICE
À SALADE**
SALADE SERVING SET
25,8 CM - 10 IN^{3/16}



**083340
PELLE À TARTE
MONOBLOC**
PASTRY SERVER
SOLID HANDLE
24,9 CM - 9 IN^{13/16}



**097717
LOUCHE**
SOUP LADLE
29,8 CM - 11 IN^{3/4}



**002179
LOUCHE À SAUCE**
SAUCE LADLE
15,7 CM - 6 IN^{3/16}

BLOIS



**104480
FOURCHETTE À GÂTEAUX/
COCKTAIL**
PASTRY/COCKTAIL FORK
13,8 CM - 5 IN^{7/16}



**104463
FOURCHETTE À HUITRES**
OYSTER FORK
12,9 CM - 5 IN^{1/16}



**195757
FOURCHETTE DE SERVICE**
SERVING FORK
24,8 CM - 9 IN^{3/4}



**195755
CUILLÈRE DE SERVICE**
SERVING SPOON
25 CM - 9 IN^{13/16}



**195757
FOURCHETTE À DÉCOUPER**
CARVING FORK
24,8 CM - 9 IN^{3/4}



**189511
COUTEAU À DÉCOUPER
MANCHE ORFÈVRE LAME UNIE**
CARVING KNIFE HOLLOW HANDLE
28,7 CM - 11 IN^{5/16}



**195750
SERVICE À SALADE**
SALADE SERVING SET
25,7 CM - 10 IN^{1/8}



**195753
PELLE À TARTE MONOBLOC**
PASTRY SERVER SOLID HANDLE
24,9 CM - 9 IN^{13/16}



**195762
LOUCHE**
SOUP LADLE
29,8 CM - 11 IN^{3/4}



**195759
LOUCHE À SAUCE**
SAUCE LADLE
15,7 CM - 6 IN^{3/16}

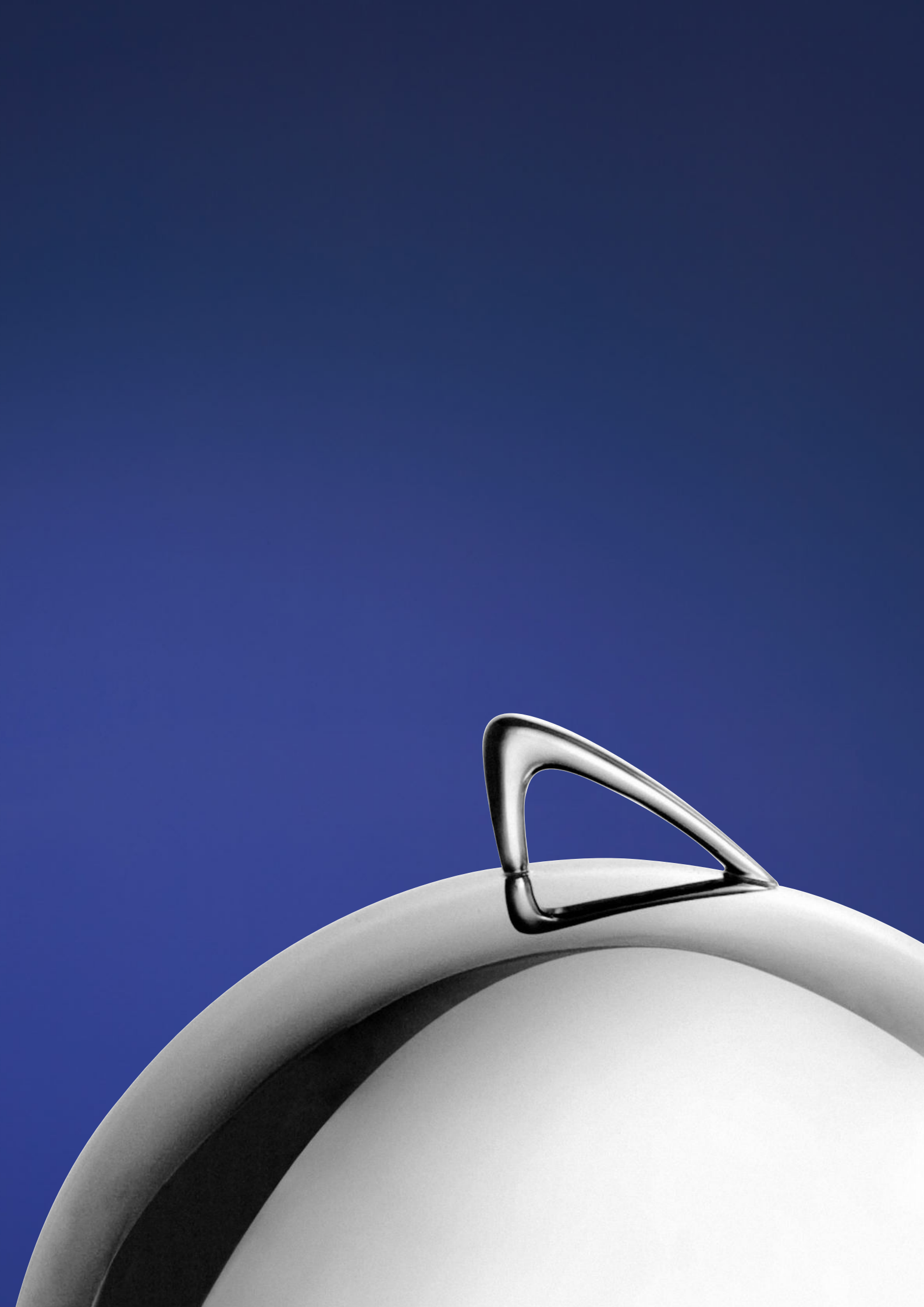



A
P L A T E R I E
H O L L O W A R E

A travers des objets en acier dédiés à la table, au service et à la dégustation, DEGRENNE exprime à travers ses collections de platerie toute la richesse de son métier d'orfèvre.

DEGRENNE expresses its highly-varied metal-working expertise through steel products designed for the table, service and tasting and appreciating.



NEWPORT PLATEAUX

Finedining

MADE IN FRANCE

DEGRENNE
PARIS

NEWPORT

PLATEAUX EMPILABLES STACKABLE SERVING TRAYS



**PLATEAUX
RECTANGULAIRES
AVEC ANSES**
RECTANGULAR
SERVING TRAYS
WITH HANDLES

★ **238953**
☞ **238963**
EXT : 77 X 55 CM - 30 IN^{5/16} X 21 IN^{5/8}
INT : 68,5 X 46,5 CM - 26 IN^{15/16} X 18 IN^{5/16}

★ **238954**
☞ **238964**
GASTRONORM 2/1
EXT : 65 X 53 CM - 25 IN^{9/16} X 20 IN^{7/8}
INT : 56,5 X 44,5 CM - 22 IN^{1/4} X 17 IN^{1/2}

★ **238955**
☞ **238965**
EXT : 60 X 40 CM - 23 IN^{5/8} X 15 IN^{3/4}
INT : 51,5 X 31,5 CM - 20 IN^{1/4} X 12 IN^{3/8}



PLATEAU ROND
ROUND TRAY

★ **185024**
☞ **186457**
EXT : 42 CM - 16 IN^{9/16}
INT : 35,1 CM - 13 IN^{13/16}



**PLATEAUX
RECTANGULAIRES
SANS ANSES**
RECTANGULAR
SERVING TRAYS
WITHOUT HANDLES

★ **238962**
☞ **238970**
GASTRONORM 1/1
EXT : 53 X 32,5 CM - 20 IN^{7/8} X 12 IN^{13/16}
INT : 46,5 X 26 CM - 18 IN^{5/16} X 10 IN^{1/4}

★ **185020**
☞ **238971**
EXT : 40 X 27 CM - 15 IN^{3/4} X 10 IN^{5/8}
INT : 33,5 X 20,5 CM - 13 IN^{3/16} X 8 IN^{1/16}

★ **238960**
☞ **238972**
GASTRONORM 1/2
EXT : 32,5 X 26,5 CM - 12 IN^{13/16} X 10 IN^{7/16}
INT : 26 X 20 CM - 10 IN^{1/4} X 7 IN^{7/8}

★ **227767**
☞ **227768**
EXT : 22 X 14 CM - 8 IN^{11/16} X 5 IN^{1/2}
INT : 20 X 12 CM - 7 IN^{7/8} X 4 IN^{3/4}

NORMANDY



**PLATEAU
RECTANGULAIRE
SANS ANSES**
RECTANGULAR
SERVING TRAY
WITHOUT HANDLES

★ **232972**
INT : 26 X 18 CM - 10 IN^{1/4} X 7 IN^{1/16}
EXT : 23 X 15 CM - 9 IN^{1/16} X 5 IN^{7/8}

NEWPORT CUBIQUE

PLATEAUX EMPILABLES STACKABLE SERVING TRAYS



**PLATEAUX
RECTANGULAIRES
AVEC ANSES**
RECTANGULAR
SERVING TRAYS
WITH HANDLES

211886
238989
GASTRONORM 2/1
EXT : 65 X 53 CM - 25 IN^{9/16} X 20 IN^{7/8}
INT : 56,5 X 44,5 CM - 22 IN^{1/4} X 17 IN^{1/2}

211887
238990
EXT : 60 X 40 CM - 23 IN^{5/8} X 15 IN^{3/4}
INT : 51,5 X 31,5 CM - 20 IN^{1/4} X 12 IN^{3/8}



**PLATEAUX
RECTANGULAIRES
SANS ANSES**
RECTANGULAR
SERVING TRAYS
WITHOUT HANDLES

238990
213859
GASTRONORM 1/2
EXT : 32,5 X 26,5 CM - 12 IN^{13/16} X 10 IN^{7/16}
INT : 26 X 20 CM - 10 IN^{1/4} X 7 IN^{7/8}

211889
213860
EXT : 22 X 14 CM - 8 IN^{11/16} X 5 IN^{1/2}
INT : 20 X 12 CM - 7 IN^{7/8} X 4 IN^{3/4}



**DESSOUS DE
BOUTEILLE**
BOTTLE
COASTER

230872
230874
13,5 CM - 5 IN^{5/16}



PLATS OVALES
OVAL DISHES

■ 238958

■ 238968

EXT : 46 X 31 CM - 18 IN^{1/8} X 12 IN^{3/16}
INT : 25,9 X 13,9 CM - 10 IN^{3/16} X 5 IN^{1/2}

■ 238957

■ 238967

EXT : 41 X 28 CM - 16 IN^{1/8} X 11 IN
INT : 28,7 X 15,6 CM - 11 IN^{5/16} X 6 IN^{1/8}

■ 238956

■ 238966

EXT : 38 X 25 CM - 14 IN^{15/16} X 9 IN^{13/16}
INT : 26,6 X 16,3 CM - 10 IN^{1/2} X 6 IN^{7/16}



PLAT À POISSON
FISH DISH

■ 238959

■ 238969

INT : 60 X 27 CM - 23 IN^{15/8} X 10 IN^{5/8}
EXT : 46,3 X 14,3 CM - 18 IN^{1/4} X 5 IN^{5/8}



SAUCIÈRE
SAUCE BOAT

■ 186198

■ 186456

19 X 7,6 CM - 20 CL
7 IN^{1/2} X 3 IN - 6 OZ^{3/4}



BEURRIER
BUTTER DISH

■ 185307

■ 186455

Ø 7,6 X 7 CM - 3 IN^{15/8} X 2 IN^{3/4}



PORTE SUCRE
CENTRE DE TABLE
SUGAR HOLDER/TABLE

■ 211397

Ø 6,4 X H 6 CM - Ø 2 IN^{1/2} X H 2 IN^{3/8}



SOCLE BEURRIER
PORCELAINE
BUTTER DISH
BASE PORCELAIN

190255

Ø 9 X 7,6 CM - 3 IN X 2 IN^{3/4}

NEWPORT TABLE

Finedining

MADE IN FRANCE





VERSEUSES
COFFEE/TEA POTS

★ **213850**
☞ **219563**
1,5 L - 18,1 CM X H 22,4 CM
50 OZ^{3/4} - 7 IN^{1/8} X H 8 IN^{3/16}

★ **213851**
☞ **219564**
70 CL - 14,8 CM X H 14,6 CM
23 OZ^{11/16} - 5 IN^{13/16} X H 5 IN^{3/4}

★ **213852**
☞ **219565**
35 CL - 12,9 CM X H 9,3 CM
11 OZ^{13/16} - 5 IN^{1/16} X H 3 IN^{11/16}



PICHET
JUG

★ **213849**
☞ **219561**
2 L - 18,1 CM X H 23 CM
67 OZ^{5/8} - 7 IN^{1/8} X H 9 IN^{1/16}



POTS ISOTHERMES
INSULATED POTS

★ **213846**
☞ **219557**
1,2 L - 18,1 CM X H 22,7 CM
40 OZ^{9/16} - 7 IN^{1/8} X H 8 IN^{15/16}

★ **213847**
☞ **219558**
70 CL - 15,6 CM X H 19,2 CM
23 OZ^{11/16} - 6 IN^{1/8} X H 7 IN^{9/16}

★ **213848**
☞ **219559**
30 CL - 13,4 CM X H 12,7 CM
40 OZ - 5 IN^{1/4} X H 5 IN



CRÉMIERS
CREAM JUGS

★ **213853**
☞ **219566**
35 CL - 12,9 CM X H 9 CM
11 OZ^{13/16} - 5 IN^{1/16} X H 3 IN^{9/16}

★ **213854**
☞ **219567**
15 CL - 9 CM X H 9 CM
5 OZ^{1/16} - 3 IN^{9/16} X H 3 IN^{9/16}



SUCRIER
SUGAR BOWL

★ **182341**
☞ **184612**
35 CL
11 OZ^{13/16}



NEWPORT
P. 78



NEWPORT CAFÈTERIE

Finedining

MADE IN FRANCE





SEAU À CHAMPAGNE * 184180
2 BOUTEILLES 188895
 CHAMPAGNE BUCKET Ø 24 X H 25,5 CM
 2 BOTTLES Ø 9 IN^{7/16} X H 10 IN^{1/16}

SEAU À CHAMPAGNE * 186030
1 BOUTEILLE 188894
 CHAMPAGNE BUCKET Ø 20 X H 22,5 CM
 1 BOTTLE Ø 7 IN^{7/8} X H 8 IN^{2/8}



SEAU À GLACE * 184181
AVEC COUVERCLE 188896
 ICE BUCKET Ø 15 X H 16 CM
 WITH LID Ø 5 IN^{7/8} X H 6 IN^{5/16}



RAFRAICHISSEUR * 237501
DROIT DOUBLE PAROI Ø 13,9 X H 19,8 CM
 CURVED DOUBLE Ø 5 IN^{7/8} X H 7 IN^{13/16}
 WALL WINE COOLER

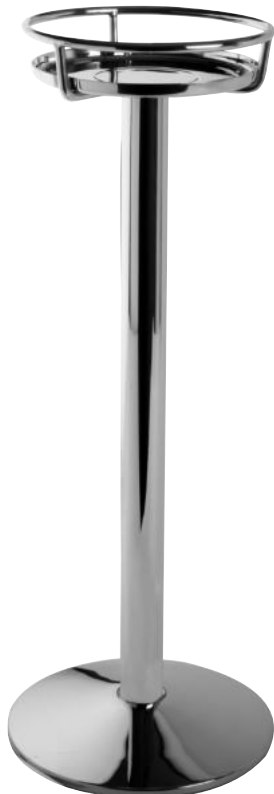

PORTE SEAU * 185607
À CHAMPAGNE 188893
(1 OU 2 BOUTEILLES) H 63,5 CM - 25 IN
 CHAMPAGNE
 BUCKET STAND
 (1 OR 2 BOTTLES)



DESSOUS DE BOUTEILLE * 234320
 BOTTLE COASTER 9,5 CM - 3 IN^{3/4}
NEWPORT LOUNGE



PINCE À GLACE * 004014
 ICE TONG 16 CM
 6 IN^{5/16}

NEWPORT BAR

Alldaydining

MADE IN FRANCE





CLOCHE ASSIETTE
DOME COVER

INOX
STAINLESS STEEL

★ 182614
☞ 184477
Ø 24 CM - 9 IN^{7/16}

★ 182301
☞ 184476
Ø 14,8 CM - 5 IN^{13/16}



INOX
STAINLESS STEEL

★ 044113
☞ 101512
Ø 26 CM - 10 IN^{1/4}

★ 044112
☞ 101510
22 CM - 8 IN^{7/8}



CLOCHE EVENTO
VERRE

239771
Ø 28 CM - 11 IN

239770
Ø 23 CM - 9 IN^{1/6}

239769
Ø 16 CM - 6 IN^{5/16}



VERRE BOROSILICATE
GLASS

204043
17 X 9 CM - 6 IN^{11/16} X 3 IN^{9/16}

206504
BOUCHON PORCELAINE
PORCELAIN LID
5,2 CM - 2 IN^{1/16}



CORBEILLE RONDE À PAIN
ROUND BREAD BASKET

★ 128910
☞ 131114
Ø 17,5 X H 6 CM
Ø 6 IN^{7/8} X H 2 IN^{3/8}

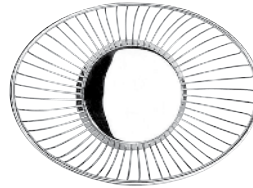

CORBEILLE OVALE À PAIN
OVAL BREAD BASKET

★ 128912
☞ 131117
Ø 24 X 17 CM - H 7,5 CM
Ø 9 IN^{7/16} X 6 IN^{11/16} - H 2 IN^{15/16}

★ 128911
☞ 131118
Ø 20 X 15 CM - H 6 CM
Ø 7 IN^{7/8} X 5 IN^{7/8} - H 2 IN^{3/8}



VERRINE SEL/POIVRE AIMANTÉE
SALT & PEPPER CELLAR W/MAGNET

216920
216919
4,1 X 6,7 CM
1 IN^{5/8} X 2 IN^{5/8}

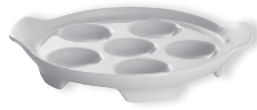

PLAT À ESCARGOTS PORCELAINE
SNAIL TONG PORCELAIN

164138
Ø 16,6 CM - 6 IN^{5/16}



ENSEMBLE SEL/POIVRE AIMANTÉE
SALT & PEPPER CELLAR W/MAGNET

216922
8,5 X 10,6 CM
3 IN^{3/8} X 4 IN^{3/16}



PINCE À ESCARGOTS
SNAIL TONG

★ 004013
16 CM - 6 IN^{5/16}



CISEAUX À GÂTEAUX
PASTRY SCISSORS/TONG

★ 204496
☞ 101494
20 CM - 7 IN^{7/8}



PINCE À PAIN BREAD TONG

★ 204498
☞ 101492
23 CM - 9 IN^{1/16}



PINCE À CRUSTACÉS
SEAFOOD/CRAKER

★ 184492
16,5 CM - 6 IN^{1/2}



PINCE À SERVIR SERVING TONG

★ 204499
☞ 184355
29,5 CM - 11 IN^{5/8}



NEWPORT ACCESSOIRES

Alldaydining

MADE IN FRANCE







LES
VERRES
GLASSWARE

Les collections de verres DEGRENNE invitent au partage et à la dégustation. Leurs qualités esthétiques ainsi que leur résistance exceptionnelle, garantissent une utilisation en toute occasion. Pour compléter harmonieusement la table, les verres de couleur DEGRENNE, teintés dans la masse, offrent une esthétique et une qualité à l'épreuve du temps et des lavages au lave-vaisselle.

DEGRENNE'S glassware collections are an invitation to socialize and enjoy a drink. Our glassware's looks and exceptional sturdiness mean that is suitable for any occasion. DEGRENNE's integrally dyed glasses are a harmonious addition to the dining table and offer looks and quality that withstand the test of time and repeated washing in the dishwasher.

ALLURE

Finedining



FLÛTE 242793
À CHAMPAGNE 26,1 CL - 8 OZ^{53/64}
 CHAMPAGNE Ø 7,25 X H 24,5 CM
 FLUTE Ø 2 IN^{55/64} X H 9 IN^{41/64}



VERRE 242792
À PIED 40,5 CL - 13 OZ^{11/16}
 STEMMED Ø 8,3 X H 24,5 CM
 GLASS Ø 3 IN^{17/64} X H 9 IN^{41/64}



VERRE 242791
À PIED 57 CL - 19 OZ^{9/32}
 STEMMED Ø 9,6 X H 25 CM
 GLASS Ø 3 IN^{25/32} X H 9 IN^{27/32}



VERRE 242790
À BORDEAUX 64,5 CL - 21 OZ^{13/16}
 BORDEAUX Ø 10,2 X H 25,5 CM
 GLASS Ø 4 IN^{1/64} X H 10 IN^{3/64}



FLÛTE 184551
À CHAMPAGNE 19 CL - 6 OZ^{7/16}
 CHAMPAGNE Ø 6,3 X H 22,4 CM
 FLUTE Ø 2 IN^{1/2} X H 8 IN^{13/16}



VERRE 184549
À VIN BLANC 28 CL - 9 OZ^{7/16}
 WHITE WINE Ø 7,4 X H 20,8 CM
 GLASS Ø 2 IN^{15/16} X H 8 IN^{3/16}



VERRE 184548
À VIN ROUGE 35 CL - 11 OZ^{13/16}
 RED WINE Ø 8 X H 21,4 CM
 GLASS Ø 3 IN^{1/8} X H 8 IN^{7/16}



VERRE 184547
À EAU 45 CL - 15 OZ^{3/16}
 WATER Ø 8,4 X H 22,5 CM
 GLASS Ø 3 IN^{5/16} X H 8 IN^{1/16}





VERRE 242789
À BOURGOGNE 71 CL - 24 OZ^{1/64}
 BURGUNDY Ø 11,6 X H 24,5 CM
 GLASS Ø 4 IN^{9/16} X H 9 IN^{41/64}



GOBELET 242795
HAUT 47 CL - 15 OZ^{57/64}
 HIGH Ø 9,15 X H 10,85 CM
 TUMBLER Ø 3 IN^{39/64} X H 4 IN^{17/64}



GOBELET 242794
BAS 39 CL - 13 OZ^{3/16}
 LOW Ø 7 X H 14,4 CM
 TUMBLER Ø 2 IN^{3/4} X H 5 IN^{43/64}

MUSE

Finedining



VERRE 184550
À BORDEAUX 64,5 CL - 21 OZ^{13/16}
 BORDEAUX Ø 9,5 X H 23,8 CM
 GLASS Ø 3 IN^{3/4} X H 9 IN^{3/8}



VERRE 210812
À BOURGOGNE 70 CL - 23 OZ^{11/16}
 BURGUNDY Ø 10,5 X H 23,1 CM
 GLASS Ø 4 IN^{1/8} X H 9 IN^{1/8}



GOBELET 184555
HAUT 36 CL - 12 OZ^{3/16}
 HIGH Ø 6,8 X H 14,2 CM
 TUMBLER Ø 2 IN^{11/16} X H 5 IN^{9/16}



GOBELET 184554
BAS 33 CL - 11 OZ^{3/16}
 LOW Ø 8 X H 10,2 CM
 TUMBLER Ø 3 IN^{1/8} X H 4 IN

184553
 23 CL - 7 OZ^{3/4}
 Ø 7,6 X H 9,2 CM
 Ø 3 IN X H 3 IN^{5/8}

DOMAINE

Alldaydining



FLÛTE 184566
À CHAMPAGNE 19 CL - 6 OZ^{7/16}
CHAMPAGNE Ø 5,3 X H 21,9 CM
FLUTE Ø 2 IN^{1/16} X H 8 IN^{5/8}



VERRE 184563
À VIN BLANC 28 CL - 9 OZ^{7/16}
WHITE WINE Ø 7,3 X H 21,2 CM
GLASS Ø 2 IN^{7/8} X H 8 IN^{3/8}



VERRE 184562
À VIN ROUGE 37 CL - 12 OZ^{1/2}
RED WINE Ø 7,7 X H 21,4 CM
GLASS Ø 3 IN^{1/16} X H 8 IN^{7/16}

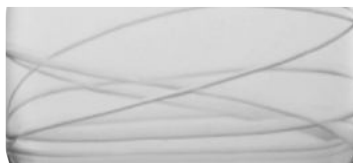

Décor taillé dans le verre
Cut-glass design



GOBELET 190538
TUMBLER 47 CL - 15 OZ^{7/8}
Ø 8,5 X H 12,1 CM
Ø 3 IN^{3/8} X H 4 IN^{3/4}





VERRE 184561
À EAU 49,5 CL - 16 OZ^{3/4}
WATER Ø 8,6 X H 22,7 CM
GLASS Ø 3 IN^{3/8} X H 8 IN^{15/16}



VERRE 184564
À BORDEAUX 65 CL - 22 OZ
BORDEAUX Ø 9,4 X H 23,9 CM
GLASS Ø 3 IN^{11/16} X H 9 IN^{7/16}



VERRE 184565
À BOURGOGNE 75 CL - 25 OZ^{3/8}
BURGUNDY Ø 10,7 X H 22,5 CM
GLASS Ø 4 IN^{3/16} X H 8 IN^{7/8}

GALATEE

Finedining



FLÛTE 184556
À CHAMPAGNE 20 CL - 6 OZ^{3/4}
CHAMPAGNE Ø 6,7 X H 21,2 CM
FLUTE Ø 2 IN^{5/8} X H 8 IN^{3/8}



VERRE 190537
À VIN 35 CL - 11 OZ^{13/16}
WINE GLASS Ø 7,8 X H 19,6 CM
Ø 3 IN^{1/16} X H 7 IN^{11/16}



VERRE À EAU 190536
WATER GLASS 45 CL - 15 OZ^{3/16}
Ø 8,4 X H 20,5 CM
Ø 3 IN^{5/16} X H 8 IN^{1/16}

MONTMARTRE

Alldaydining



FLÛTE 184580
À CHAMPAGNE 21 CL - 7 OZ^{1/8}
CHAMPAGNE Ø 7 X H 21 CM
FLUTE Ø 2 IN^{3/4} X H 8 IN^{1/4}



VERRE 184577
À VIN BLANC 25 CL - 8 OZ^{7/16}
WHITE WINE Ø 7,5 X H 18,4 CM
GLASS Ø 2 IN^{15/16} X H 7 IN^{1/4}



VERRE 184576
À VIN ROUGE 32 CL - 10 OZ^{13/16}
RED WINE Ø 7,8 X H 19,8 CM
GLASS Ø 3 IN^{1/16} X H 7 IN^{13/16}



FLÛTE 184567
À CHAMPAGNE 15 CL - 5 OZ^{1/16}
CHAMPAGNE Ø 6,3 X H 19,3 CM
FLUTE Ø 2 IN^{1/2} X H 7 IN^{5/8}



VERRE 184597
À CHAMPAGNE 21 CL - 7 OZ^{1/8}
CHAMPAGNE Ø 6,8 X H 20,5 CM
GLASS Ø 2 IN^{11/16} X H 8 IN^{1/16}



COUPE 210281
À CHAMPAGNE 23 CL - 7 OZ^{3/4}
CHAMPAGNE Ø 9,5 X H 14,7 CM
GLASS Ø 3 IN^{3/4} X H 5 IN^{13/16}





VERRE 184575
À EAU 42 CL - 14 OZ^{3/16}
 WATER GLASS Ø 8,7 X H 20,5 CM
 Ø 3 IN^{7/16} X H 8 IN^{1/16}



VERRE 184579
À BOURGOGNE 58 CL - 19 OZ^{5/8}
 BURGUNDY GLASS Ø 10 X H 20 CM
 Ø 3 IN^{5/16} X H 7 IN^{7/8}

MONTMARTRE
 JAUGÉ



VERRE 208481
À VIN ROUGE 32 CL - 10 OZ^{13/16}
AVEC Ø 7,8 X H 19,8 CM
DOUBLE JAUGE Ø 3 IN^{1/16} X H 7 IN^{13/16}
 RED WINE GLASS
 WITH 2 GAUGES

Avec double jauge
 With 2 gauges

• 14 CL - 4 OZ^{3/4}
 • 12,5 CL - 4 OZ^{1/4}

HYPNOTIC
 JAUGÉ



213816
 36,5 CL - 13 OZ
 Ø 8,2 X H 22 CM
 Ø 3 IN^{1/4} X H 8 IN^{11/16}

ANYTIME

Alldaydining



VERRE 195628
À MARTINI 25 CL - 8 OZ^{7/16}
 MARTINI GLASS Ø 10,6 X H 16,8 CM
 Ø 4 IN^{3/16} X H 6 IN^{5/8}



VERRE 184570
À COGNAC 61 CL - 20 OZ^{5/8}
 COGNAC Ø 10,4 X H 15,5 CM
 GLASS Ø 4 IN^{1/8} X H 6 IN^{1/8}



NEWPORT TWIST

Finedining

MADE IN EUROPE 

NEW





FLÛTE 244051
À CHAMPAGNE 21 CL - 8 OZ^{1/4}
 CHAMPAGNE Ø 6,3 X H 22,4 CM
 FLUTE Ø 2 IN^{1/2} X H 8 IN^{13/16}



VERRE 244059
À VIN 36 CL - 12 OZ^{3/16}
 WINE GLASS Ø 8 X H 22,5 CM
 Ø 3 IN^{1/8} X H 8 IN^{7/8}



VERRE 244057
À EAU 47 CL - 15 OZ^{7/8}
 WHITE WINE Ø 9,3 X H 24 CM
 GLASS Ø 3 IN^{11/16} X H 9 IN^{7/16}



COUPE À GLACE/ 244053
COCKTAIL 28 CL - 11 OZ
 COCKTAIL/ICE Ø 8 X H 21,4 CM
 CUP GLASS Ø 3 IN^{1/8} X H 8 IN^{7/16}



CARAFE 244910
 CARAFE 100 CL - 33 OZ^{13/16}
 Ø 8,8 X H 28,3 CM
 Ø 3 IN^{7/16} X H 11 IN^{1/8}



244910 **NEW**
 100 CL - 33 OZ^{13/16}
 Ø 8,8 X H 28,3 CM
 Ø 3 IN^{7/16} X H 11 IN^{1/8}



NEWPORT TWIST

Finedining

MADE IN EUROPE

NEW



VERRE 244049
À MARTINI 21 CL - 8 OZ^{1/4}
MARTINI GLASS Ø 7,4 X H 20,8 CM
Ø 2 IN^{15/16} X H 8 IN^{1/16}



VERRE 244055
À LIQUEUR 7,5 CL - 2 OZ^{15/16}
BURGUNDY GLASS Ø 6,3 X H 22,4 CM
Ø 2 IN^{1/2} X H 8 IN^{15/16}



VERRINE 244047
APÉRITIF 27 CL - 10 OZ^{5/8}
VERRINE Ø 7,4 X H 20,8 CM
APPETIZER Ø 2 IN^{15/16} X H 8 IN^{1/16}



GOBELET 244061
HAUT 37 CL - 12 OZ^{1/2}
HIGH Ø 6,5 X H 16 CM
DRINK Ø 2 IN^{9/16} X H 6 IN^{5/16}



COFFRET SET WHISKY 241875
2 VERRES + CARAFE 21 CL - 7 OZ^{1/8}
EMPILABLES 31,9 CM
2 GLASSES & CARAFE 12 IN^{9/16}
STACKABLE SET



CARAFE 242961
CARAFE 25 CL - 8 OZ^{7/16}
18 CM
7 IN^{1/16}



GOBELET 242959
BAS 25 CL - 8 OZ^{7/16}
SHORT Ø 7,4
DRINK Ø 2 IN^{15/16}

TRANSPARENT
TRANSPARENT



VERRE 234149
À PIED 26 CL - 8 OZ^{3/4}
STEMMED Ø 7,9 X H 11,1 CM
GLASS Ø 3 IN^{1/8} X H 4 IN^{3/8}

BLEU
BLUE



236287
26 CL - 8 OZ^{3/4}
Ø 7,9 X H 11,1 CM
Ø 3 IN^{1/8} X H 4 IN^{3/8}

VERT
GREEN



242553
26 CL - 8 OZ^{3/4}
Ø 7,9 X H 11,1 CM
Ø 3 IN^{1/8} X H 4 IN^{3/8}

GRIS
GREY



242555
26 CL - 8 OZ^{3/4}
Ø 7,9 X H 11,1 CM
Ø 3 IN^{1/8} X H 4 IN^{3/8}



GOBELET 234150
TUMBLER 26 CL - 8 OZ^{3/4}
Ø 7,1 X H 9,1 CM
Ø 2 IN^{13/16} X H 3 IN^{9/16}



236289
26 CL - 8 OZ^{3/4}
Ø 7,1 X H 9,1 CM
Ø 2 IN^{13/16} X H 3 IN^{9/16}



242552
26 CL - 8 OZ^{3/4}
Ø 7,1 X H 9,1 CM
Ø 2 IN^{13/16} X H 3 IN^{9/16}



242554
26 CL - 8 OZ^{3/4}
Ø 7,1 X H 9,1 CM
Ø 2 IN^{13/16} X H 3 IN^{9/16}



CARAFE 234148
EMPILEO 75 CL - 25 OZ^{3/8}
PITCHER Ø 9,1 X H 24 CM
Ø 3 IN^{9/16} X H 4 IN^{3/8}



236288
75 CL - 25 OZ^{3/8}
Ø 9,1 X H 24 CM
Ø 3 IN^{9/16} X H 4 IN^{3/8}



• **VERRE SOUFFLÉ BOUCHE**
TEINTÉ DANS LA MASSE
HAND-BLOWN INTEGRALLY
DYED GLASS



• **EMPILABILITÉ**
STACKABLE



EMPILEO

Alldaydining



L'abus d'alcool est dangereux pour la santé
Alcohol abuse is dangerous for your health

LOOP

Alldaydining



GOBELET 184601
HAUT 39 CL - 13 OZ^{13/16}
HIGH Ø 6,6 X H 14,5 CM
TUMBLER Ø 2 IN^{5/8} X H 5 IN^{11/16}



GOBELET 184600
BAS 35 CL - 11 OZ^{13/16}
LOW Ø 7,9 X H 9,1 CM
TUMBLER Ø 3 IN^{1/8} X H 3 IN^{9/16}



GOBELET BAS/ 184598
VERRINE 19 CL - 6 OZ^{7/16}
LOW TUMBLER/ APPETIZER GLASS
Ø 6,7 X H 8,1 CM
Ø 2 IN^{5/8} X H 3 IN^{3/16}



COSMOPOLITAIN

Alldaydining



GOBELET 184589
HAUT 35 CL - 11 OZ^{13/16}
HIGH Ø 6,5 X H 14,4 CM
TUMBLER Ø 2 IN^{9/16} X H 5 IN^{11/16}



GOBELET 184588
HAUT 29 CL - 9 OZ^{13/16}
HIGH Ø 7 X H 10,7 CM
TUMBLER Ø 2 IN^{3/4} X H 4 IN^{3/16}



GOBELET 189774
BAS 42 CL - 14 OZ^{3/16}
LOW Ø 8,5 X H 10,6 CM
TUMBLER Ø 3 IN^{3/8} X H 4 IN^{3/16}



GOBELET 184586
BAS 32 CL - 10 OZ^{13/16}
LOW Ø 8 X H 9,4 CM
TUMBLER Ø 3 IN^{1/8} X H 3 IN^{11/16}



INSTANT

Alldaydining

MADE IN EUROPE 



GOBELET 243491
TUMBLER 18 CL - 6 OZ^{1/16}
Ø 6 X H 8,2 CM
Ø 2 IN^{3/8} X H 3 IN^{3/4}



243493
26,5 CL - 8 OZ^{15/16}
Ø 6 X H 11,3 CM
Ø 2 IN^{3/8} X H 4 IN^{7/8}



243495
32 CL - 10 OZ^{13/16}
Ø 6 X H 13,7 CM
Ø 2 IN^{3/8} X H 5 IN^{3/8}



243497
40 CL - 13 OZ^{1/2}
Ø 6 X H 16,5 CM
Ø 2 IN^{3/8} X H 6 IN^{1/2}



DOLCE

Finedining



VERRES SOUFLÉS BOUCHE TEINTÉS DANS LA MASSE
HAND-BLOWN INTEGRALLY DYED GLASSES

MADE IN EUROPE 



GOBELET 169851
HAUT 57 CL - 19 OZ^{1/4}
HIGH Ø 6,7 X H 11,5 CM
TUMBLER Ø 2 IN^{5/8} X H 4 IN^{1/2}



GOBELET 169852
BAS 43 CL - 14 OZ^{9/16}
LOW Ø 6,1 X H 10 CM
TUMBLER Ø 2 IN^{3/8} X H 3 IN^{15/16}



ROC

Alldaydining



VERRES SOUFLÉS BOUCHE
HAND-BLOWN GLASSES



VERRE 236340
À PIED 27 CL - 9 OZ^{1/8}
STEMMED Ø 7,2 X H 11,5 CM
GLASS Ø 2 IN^{13/16} X H 4 IN^{1/2}



GOBELET 236338
BAS 18 CL - 7 OZ^{1/16}
LOW Ø 7,2 X H 6,5 CM
TUMBLER Ø 2 IN^{13/16} X H 2 IN^{9/16}



GOBELET 236339
HAUT 45 CL - 15 OZ^{3/16}
HIGH Ø 7,2 X H 14 CM
TUMBLER Ø 2 IN^{13/16} X H 5 IN^{1/2}





• **VERRE SOUFFLÉ BOUCHE**
TEINTÉ DANS LA MASSE
HAND-BLOWN INTEGRALLY
DYED GLASS

ROUGE
RED



GOBELET **225516**
TUMBLER 29 CL - 9 OZ^{13/16}
Ø 7,2 X H 9,5 CM
Ø 2 IN^{13/16} X H 3 IN^{3/4}

NOIR
BLACK



180936
29 CL - 9 OZ^{13/16}
Ø 7,2 X H 9,5 CM
Ø 2 IN^{13/16} X H 3 IN^{3/4}

CASSIS
PURPLE



174510
29 CL - 9 OZ^{13/16}
Ø 7,2 X H 9,5 CM
Ø 2 IN^{13/16} X H 3 IN^{3/4}



ALLEGRO

Alldaydining

TRANSPARENT
TRANSPARENT



GOBELET 206936
TUMBLER 29 CL - 9 OZ^{13/16}
Ø 7,2 X H 9,5 CM
Ø 2 IN^{13/16} X H 3 IN^{3/4}

GRIS
GREY



225517
29 CL - 9 OZ^{13/16}
Ø 7,2 X H 9,5 CM
Ø 2 IN^{13/16} X H 3 IN^{3/4}

BLEU NUIT
BLUE NIGHT



199461
29 CL - 9 OZ^{13/16}
Ø 7,2 X H 9,5 CM
Ø 2 IN^{13/16} X H 3 IN^{3/4}

BLANC
WHITE



180939
29 CL - 9 OZ^{13/16}
Ø 7,2 X H 9,5 CM
Ø 2 IN^{13/16} X H 3 IN^{3/4}

MAMBO

Alldaydining



• **VERRE SOUFFLÉ BOUCHE**
TEINTÉ DANS LA MASSE
HAND-BLOWN INTEGRALLY
DYED GLASS



• **EMPILABILITÉ**
STACKABLE

GRIS
GREY



GOBELET 171631
TUMBLER 34 CL - 11 OZ^{1/2}
Ø 8,5 X H 10 CM
Ø 3 IN^{3/8} X H 3 IN^{15/16}

VERT
GREEN



171632
34 CL - 11 OZ^{1/2}
Ø 8,5 X H 10 CM
Ø 3 IN^{3/8} X H 3 IN^{15/16}

VIOLET
PURPLE



171633
34 CL - 11 OZ^{1/2}
Ø 8,5 X H 10 CM
Ø 3 IN^{3/8} X H 3 IN^{15/16}

ROUGE
RED



171630
34 CL - 11 OZ^{1/2}
Ø 8,5 X H 10 CM
Ø 3 IN^{3/8} X H 3 IN^{15/16}



TRANSPARENT
TRANSPARENT



CARAFE 234148
EMPILEO 75 CL - 25 OZ^{3/8}
PITCHER Ø 9,1 X H 24 CM
Ø 3 IN^{9/16} X H 4 IN^{3/8}

BLEU
BLUE



236288
75 CL - 25 OZ^{3/8}
Ø 9,1 X H 24 CM
Ø 3 IN^{9/16} X H 4 IN^{3/8}



CARAFE À JUS 202639
DE FRUITS 1,2 L - 40 OZ^{3/16}
EVENTO Ø 10,5 X H 27,5 CM
JUICE / Ø 4 IN^{1/8} X H 10 IN^{13/16}
BEVERAGE
CARAFE



BOUCHON DE 202855
CARAFE Ø 6,5 CM - 2 IN^{9/16}
SILICONE
EVENTO
SILICONE
STOPPER
FOR CARAFE



COFFRET SET WHISKY 241875
2 VERRES + CARAFE 21 CL - 7 OZ^{1/8}
EMPILABLES 31,9 CM
2 GLASSES & CARAFE 12 IN^{9/16}
STACKABLE SET



CARAFE 244910 **NEW**
CARAFE 100 CL - 33 OZ^{13/16}
Ø 8,8 X H 28,3 CM
Ø 3 IN^{7/16} X H 11 IN^{1/8}



DECANTEUR 169728
MILLÉSIME 1,35 L - 45 OZ^{5/8}
DECANTER Ø 20,5 X H 23,5 CM
Ø 8 IN^{1/16} X H 9 IN^{1/4}



DECANTEUR 210904
NECTAR 1 L - 33 OZ^{13/16}
DECANTER Ø 13,5 X H 24,5 CM
Ø 5 IN^{5/16} X H 9 IN^{5/8}



CARAFES - DÉCANTEURS







L E B U F F E T E V E N T O B U F F E T

Du petit-déjeuner au dîner, des buffets sucrés aux buffets salés, la collection EVENTO répond à tous les scénarios de réception tout en assurant une hygiène parfaite pour satisfaire au mieux les nouvelles exigences de vos clients.

From breakfast to dinner, from sweet buffets to savoury spreads, the EVENTO collection works for all your reception needs while ensuring perfect hygiene to best meet the new requirements of your customers.



EVENTO

Buffet



Le buffet EVENTO au design homogène, harmonieux, fonctionnel et modulable, dispose de nombreux produits qui éviteront d'exposer leur contenu à l'air libre tout en conservant les aliments au frais comme au chaud et qui peuvent être utilisés pour la majorité en portion individuelle ou à usage unique. La richesse de ses combinaisons et la diversité de ses matériaux (acier, porcelaine, verre, grès, mélamine pierre et bois etc...) s'adaptent à votre style et à la dimension de votre établissement. La collection EVENTO valorise avec une touche de chic la mise en scène de vos buffets, selon le moment de la journée, de la saison...

The EVENTO buffet with a unified, harmonious, practical and modular design has many products that will avoid exposing their contents to the open air while keeping the food cool as well as warm and which can be used for the most part in individual portions or single use. With a host of combinations and a range of materials to choose from (steel, porcelain, glass, stoneware, melamine, stone and wood...), you can find what works for your style and the size of your space. The EVENTO collection adds a chic touch to your buffet presentations to reflect the time of day or the season.

CHAFING DISHES*

Couvercle en verre transparent pour percevoir le contenu et rendre le buffet plus gourmand

Clear glass cover allows contents to be viewed instantly and makes the buffet more enticing

Charnière avec vérin et amortisseur pour un réel confort d'utilisation et une fermeture en douceur

The hydraulic buffering hinge offers user comfort and convenience with its soft closure mechanism

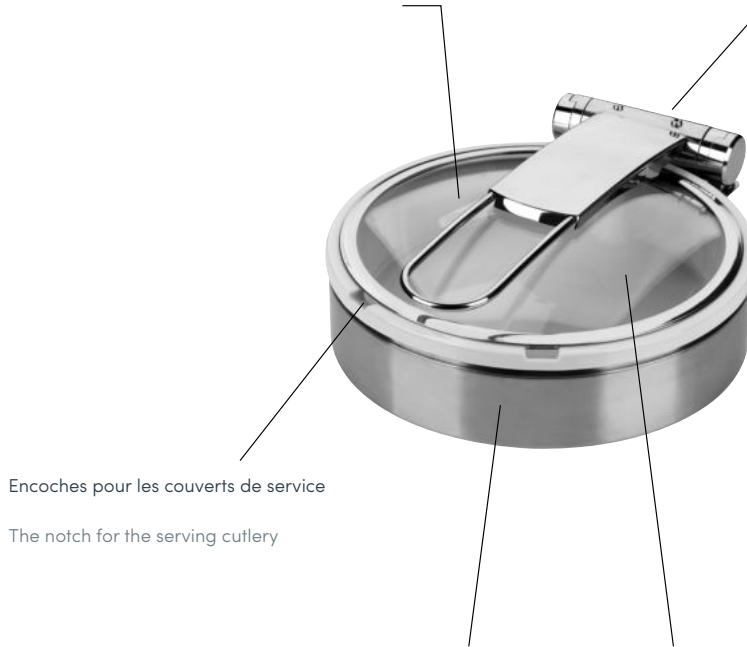

Encoches pour les couverts de service

The notch for the serving cutlery

Compatible plaque induction, avec résistance électrique ou porte-brûleur avec gel combustible

Compatible with induction, electrical and/or «sterno» fuel heating system

Acier inoxydable, couvercle avec gouttière, verre trempé, système de récupération d'eau de condensation

Stainless steel, lid with groove, condensation water collection system in the porcelain insert



35,5 CM - 14 IN

41 CM - 16 IN U.S.

Ø 35,5 CM X P 41 CM X H 15 CM
Ø 14 IN X D 16 IN^{1/8} X H 5 IN^{7/8}

2 FINITIONS
FINISHES

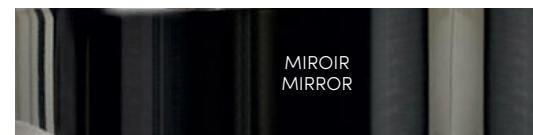

MIROIR
MIRROR



BROSSÉ
BRUSHED

*Certaines pièces sont disponibles en pièces détachées
Some items are available individually

CHAFING DISHES



Le Chafing dish, par son design contemporain alliant acier, porcelaine et verre offre à votre buffet une présentation soignée et raffinée.
The Chafing dish, with its contemporary design that combines steel, porcelain and glass, brings a smart and sophisticated touch to your buffet display.

CHAFING DISHES*

FINITION MIROIR
MIRROR FINISH



FINITION BROSSÉE
BRUSHED FINISH



CHAFING DISH 236195
SANS BAC Ø 35,5 CM - P 41 CM - H 15 CM
ACIER INOXYDABLE Ø 14 IN - D 16 IN^{1/8} - H 5 IN^{7/8}
+ COUVERCLE
AVEC GOUTTIÈRE
VERRE TREMPÉ
CHAFING DISH
WITHOUT INSERT
STAINLESS STEEL
+ LID WITH GROOVE,
TEMPERED GLASS

236194
Ø 35,5 CM - P 41 CM - H 15 CM
Ø 14 IN - D 16 IN^{1/8} - H 5 IN^{7/8}



SUPPORT CHAFING 203005
ACIER INOXYDABLE Ø 35 CM - P 40 CM - H 12,5 CM
POUR RÉSISTANCE ÉLECTRIQUE Ø 13 IN^{3/4} - D 15 IN^{3/4} - H 4 IN^{15/16}
OU PORTE-BRÛLEUR
AVEC GEL COMBUSTIBLE
CHAFING STAND STAINLESS STEEL,
FOR ELECTRICAL AND/OR
STERNO HEATING PURPOSES

202859
Ø 35 CM - P 40 CM - H 12,5 CM
Ø 13 IN^{3/4} - D 15 IN^{3/4} - H 4 IN^{15/16}

*Certaines pièces sont disponibles en pièces détachées
Some items are available individually

ACIER
STAINLESS STEEL

PORCELAINE
PORCELAIN



COUVERCLE 203470
AVEC GOUTTIÈRE ACIER, Ø 33 CM - 13 IN
VERRE TREMPÉ
LID WITH STAINLESS STEEL
GUTTER,
TEMPERED GLASS



BAC POUR 216142
CHAFING DISH Ø 35,6 X H 7 CM
CHAFING INSERT
CONTENANCE 3L
Ø 14 X 2 IN^{3/4}
CAPACITY 100 OZ



215721
Ø 35,6 X H 7 CM
CONTENANCE 3L
Ø 14 X 2 IN^{3/4}
CAPACITY 100 OZ



RÉSISTANCE 202860
AVEC RÉGULATEUR 220 /240 V /200 W
DE TEMPÉRATURE 20 X 20 CM - 7 IN^{7/8} X 7 IN^{7/8}
HEATING ELEMENT -
HEAT ADJUSTABLE
203468
110 /120 V
20 X 20 CM - 7 IN^{7/8} X 7 IN^{7/8}



1/2 BAC PORCELAINE 202635
POUR L 29 X L 15 X H 4,5 CM
CHAFING DISH CONTENANCE 1L
1/2 CHAFING 11 IN^{7/16} X 5 IN^{7/8} X 1 IN^{3/4}
PORCELAIN INSERT CAPACITY 33 OZ^{13/16}



PORTE-BRÛLEUR 243950
POUR GEL Ø 9 CM - H 6 CM
COMBUSTIBLE ACIER Ø 3 IN^{9/16} X 2 IN^{3/8}
BURNER HOLDER STEEL

***À commander obligatoirement avec le bac pour chafing dish (216142 ou 215721)**
Must be ordered with the chafing insert (216142 or 215721)

REFRIGERATED UNITS*

56,5 CM - 22 IN^{1/4}



36 CM - 14 IN^{13/16}

L 56,5 CM X P 36 CM X H 9,5 CM
22 IN^{1/4} X D 14 IN^{3/16} X 3 IN^{3/4}

FINITION MIROIR
MIRROR FINISH

FINITION BROSSÉE
BRUSHED FINISH

FINITION NOIR MÉTALLISÉ
METALLIC BLACK FINISH



MODULE ACIER 202864
+ BAC PLASTIQUE⁽¹⁾ GN1/1
REFRIGERATED SET L 56,5 CM - P 36 CM - H 9,5 CM
+ PLASTIC TRAY 22 IN^{1/4} - D 14 IN^{3/16} X 3 IN^{3/4}

202865
GN1/1
L 56,5 CM - P 36 CM - H 9,5 CM
22 IN^{1/4} - D 14 IN^{3/16} X 3 IN^{3/4}

202869
GN1/1
L 56,5 CM - P 36 CM - H 9,5 CM
22 IN^{1/4} - D 14 IN^{3/16} X 3 IN^{3/4}

235356
GN1/2
29,5 X 35,6 CM
11 IN^{5/8} X 14 IN

235361
GN1/2
29,5 X 35,6 CM
11 IN^{5/8} X 14 IN

235362
GN1/2
29,5 X 35,6 CM
11 IN^{5/8} X 14 IN



COUVERCLE 202871
MODULE RÉFRIGÉRÉ 56 X 35 X 19 CM
POIGNÉE INOXYDABLE 22 IN^{1/16} X 13 IN^{3/4} X 7 IN^{1/2}
LID FOR REFRIGERATED SET/
STAINLESS STEEL HANDLE

PLAQUE EUTECTIQUE 208357
NOIRE POUR GN1/1
MODULE FROID 48 X 28 X 3 CM
BLACK COOLING 18 IN^{7/8} X 11 IN X 1 IN^{3/16}
EUTECTIC BLOCK
FOR UNIT

239786
GN1/2
18 X 25 CM
7 IN^{18/16} X 9 IN^{13/16}

3 FINITIONS
FINISHES

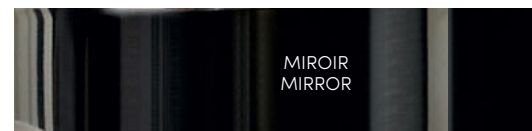

MIROIR
MIRROR

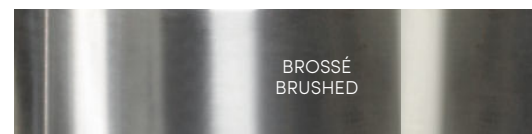

BROSSÉ
BRUSHED



NOIR MÉTALLISÉ
METALLIC BLACK

*Certaines pièces sont disponibles en pièces détachées
Some items are available individually

(1) Garantie lave-vaisselle
Dish washer safe

MODULES FROIDS



Le module réfrigéré reçoit une large gamme de contenants, plateaux et accessoires multi-matériaux au format GN en porcelaine, verre, acier, acrylique, mélamine pierre et mélamine bois. Ils permettent une infinité de combinaisons.

The refrigerated unit will hold a wide range of platters and multi-material accessories in Industry standard format in porcelain, glass, steel, acrylic stone and wood melamine allowing endless combinations.

PLATEAUX POUR MODULES FROIDS PLATTERS FOR REFRIGERATED UNITS

MÉLAMINE BOIS⁽¹⁾
WOOD MELAMINE TRAY



MÉLAMINE PIERRE⁽¹⁾
STONE MELAMINE TRAY



ACIER 18/10 NEWPORT
FINITION MIROIR
SERVING TRAY STAINLESS STEEL
18/10 MIRROR FINISHED



PLATEAUX 234546

TRAYS **GN1/1**
53,5 X 32,5 CM
20 IN^{7/8} X 12 IN^{13/16}

234548
GN 2/3
35,4 X 32,5 CM
13 IN^{15/16} X 12 IN^{13/16}

234551
GN 1/2
26,4 X 32,5 CM
10 IN^{3/8} X 12 IN^{13/16}

234553
GN 1/3
17,5 X 32,5 CM
6 IN^{7/8} X 12 IN^{13/16}

234547

GN1/1
53,5 X 32,5 CM
20 IN^{7/8} X 12 IN^{13/16}

234549
GN 2/3
35,4 X 32,5 CM
13 IN^{15/16} X 12 IN^{13/16}

234552
GN 1/2
26,4 X 32,5 CM
10 IN^{3/8} X 12 IN^{13/16}

234554
GN 1/3
17,5 X 32,5 CM
6 IN^{7/8} X 12 IN^{13/16}

238962

GN1/1
53,5 X 32,5 CM
20 IN^{7/8} X 12 IN^{13/16}

238960
GN 1/2
26,4 X 32,5 CM
10 IN^{3/8} X 12 IN^{13/16}



PLATEAUX
3 TROUS
3 HOLES TRAYS

234557
GN 1/6
8,7 X 32,5 CM
3 IN^{7/16} X 12 IN^{13/16}



234558
GN 1/6
8,7 X 32,5 CM
3 IN^{7/16} X 12 IN^{13/16}

(1) Compatible lave-vaisselle, NON compatible micro-ondes
Dish washer safe, DONT USE with micro-wave

VERRE ÉPAISSEUR 0,6 CM
TEMPERED GLASS THICKNESS IN^{1/4}

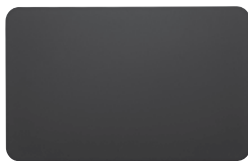

230752

GN 1/1

53,5 X 32,5 CM

20 IN^{7/8} X 12 IN^{13/16}

230753

GN 2/3

35,4 X 32,5 CM

13 IN^{15/16} X 12 IN^{13/16}

ACRYLIQUE ÉPAISSEUR 1 CM
ACRYLIC THICKNESS IN^{3/8}

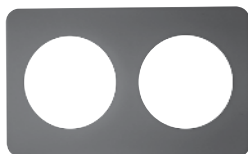

230756

GN 1/1 - 2 TROUS

2 HOLES

53,5 X 32,5 CM - 20 IN^{7/8} X 12 IN^{13/16}

230757

GN 1/3 - 2 TROUS - BOLS 14 CM

2 HOLES - BOWLS 5,5 IN

17,5 X 32,5 CM - 6 IN^{7/8} X 12 IN^{13/16}



COMPATIBLES AVEC BOLS
AVAILABLE WITH BOWLS

136529

24 CM - 9 IN^{7/16}

CONTENANCE : 2 L

CAPACITY : 67 OZ^{5/8}

H : 11 CM - 4 IN^{1/4}

136511

20 CM - 7 IN^{7/8}

CONTENANCE : 1,30 L

CAPACITY : 43 OZ^{15/16}

H : 9,5 CM - 3 IN^{3/4}

GRÈS CARBONE (2)
GREY STONEWARE



234550

GN 2/3

35,4 X 32,5 CM

13 IN^{15/16} X 12 IN^{13/16}

234555

GN 1/3

17,5 X 32,5 CM

6 IN^{7/8} X 12 IN^{13/16}



PLATEAU À REBORDS **234556**
GN 1/3

17,5 X 32,5 CM

6 IN^{7/8} X 12 IN^{13/16}

PORCELAINE (2)
WHITE ENAMELLED PORCELAIN



202628

GN 2/3

35,4 X 32,5 CM

13 IN^{15/16} X 12 IN^{13/16}

202629

GN 1/2

26,4 X 32,5 CM

10 IN^{3/8} X 12 IN^{13/16}

202627

GN 1/3

17,5 X 32,5 CM

6 IN^{7/8} X 12 IN^{13/16}



PLAT CREUX **202630**
PORCELAINE GN 1/3

17,5 X 32,5 CM

6 IN^{7/8} X 12 IN^{13/16}

URNES À JUS DE FRUITS* FRUIT JUICE URNS

Urne à jus de fruit dotée d'un tube central en acier pour glace pilée : parfait maintien de la fraîcheur
Fruit juice urn with central steel tube to hold crushed ice, for perfect freshness



FINITION MIROIR
MIRROR FINISH

FINITION BROSSÉE
BRUSHED FINISH

**URNE À JUS
DE FRUITS 4L
ACIER 18-10**

231303
L 20 CM X P 32 CM X H 45 CM
W 7 IN^{7/8} X D 12 IN^{5/8} X H 17 IN^{11/16}

231304
L 20 CM X P 32 CM X H 45 CM
W 7 IN^{7/8} X D 12 IN^{5/8} X H 17 IN^{11/16}

JUICE DISPENSER 135 OZ
STAINLESS STEEL

CRISTALLIN SOUFLÉ BOUCHE
HAND BLOWN CRYSTALLINE



CARAFE À JUS 202639
DE FRUIT - 1,2 L Ø 10,5 CM - H 27,5 CM
JUICE/BEVERAGE Ø 4 IN^{1/8} X H 10 IN^{13/16}
CARAFE - 40 OZ^{9/16}

PORCELAINE
PORCELAIN



CARAFE 202636
À LAIT - 1,2 L Ø 10,5 CM - H 27,5 CM
MILK JUG Ø 4 IN^{1/8} X H 10 IN^{13/16}
- 40 OZ^{9/16}

Bouchon verseur, pour une meilleure hygiène
Hygienic pouring stopper



BOUCHON DE 202855
CARAFE SILICONE Ø 6,5 CM - H 4,2 CM
STOPPER FOR Ø 2 IN^{9/16} X H 1 IN^{5/8}
CARAFE SILICONE

*Certaines pièces sont disponibles en pièces détachées
Some items are available individually

DISTRIBUTEURS À CÉRÉALES* CEREAL DISPENSERS

Distributeur à céréales 1 ou 3 tubes avec ailettes souples pour ne pas casser les céréales
Cereal dispenser 1 or 3 tubs with flexible spout so as not to break the cereals



X3

DISTRIBUTEUR À CÉRÉALES 231300

CEREAL DISPENSER L 50 CM X P 20 CM X H 55,5 CM
W 19 IN^{11/16} X D 7 IN^{7/8} X H 21 IN^{7/8}
CAPACITÉ : 3 X 3,5 L
CAPACITY : 3 X 1 GAL



X1

231299

L 19 CM X P 20 CM X H 55,5 CM
W 7 IN^{1/2} X D 7 IN^{7/8} X H 21 IN^{7/8}
CAPACITÉ : 3,5 L
CAPACITY : 1 GAL



RAFRAICHISSEUR 237501

DROIT Ø 13,9 X H 19,8 CM
DOUBLE PAROI Ø 5 IN^{7/8} X H 7 IN^{13/16}
CURVED
DOUBLE WALL
WINE COOLER



BOL 154245

PORCELAINE MODULO BLANC
PORCELAIN BOWL WHITE MODULO
14 CM - 5 IN^{1/2}

202626
EMPILABLE
STACKABLE



ETIQUETTE PORCELAINE 202632

AVEC AIMANT 10 X 5 CM
+ SUPPORT ACIER 3 IN^{5/16} X 1 IN^{15/16}
PORCELAIN STICK +
STAINLESS STEEL STAND
WITH MAGNET

TRAYS



Panière reversible pour une présentation droite ou inclinée
Reversible basket for a level or titled display

SUPPORTS À FIL



Des supports en acier noir mat de hauteurs différentes pour rythmer les présentations.
Black mat finish supports of differing heights can be used to create a varied presentation.

SUPPORTS À FIL RECTANGULAIRES RECTANGULAR TRAYS



1

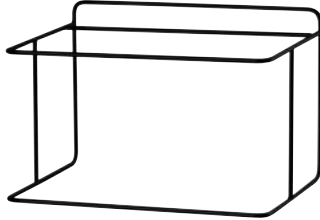

2

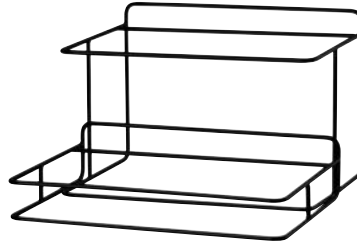

1 + 2



PANIÈRE 230749
RECTANGULAIRE GN 1/1
 RECTANGULAR 54 X 34 X H 7 CM
 BREAD BASKET 21 IN^{1/4} X 13 IN^{3/8} X 2 IN^{3/4}

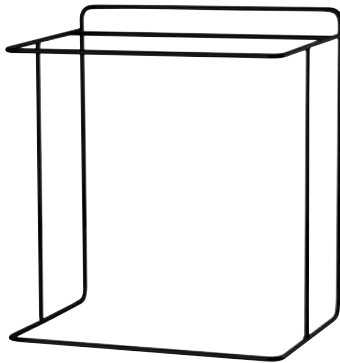

3

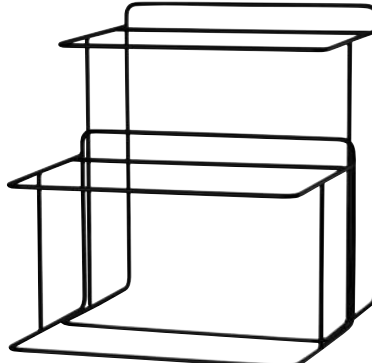

2 + 3



1 + 2 + 3

SUPPORT 230741
RECTANGULAIRE NIVEAU 1
 RECTANGULAR TRAY LEVEL 1
 L 44 X P 30,8 X H 10,8 CM
 W 17 IN^{5/16} X D 12 IN^{1/8} X H 4 IN^{1/4}

230742
NIVEAU 2
 LEVEL 2
 L 42 X P 30,8 X H 29,8 CM
 W 16 IN^{5/16} X D 12 IN^{1/8} X H 11 IN^{3/4}

230743
NIVEAU 3
 LEVEL 3
 L 40 X P 30,8 X H 48,8 CM
 W 15 IN^{3/4} X D 12 IN^{1/8} X H 19 IN^{3/16}

230741 + 230742
NIVEAU 1 + 2
 LEVEL 1+2
 L 44 X P 50 X H 29,8 CM
 W 17 IN^{5/16} X D 19 IN^{11/16} X H 11 IN^{3/4}

230742 + 230743
NIVEAU 2 + 3
 LEVEL 2+3
 L 42 X P 50 X H 48,8 CM
 W 16 IN^{5/16} X D 19 IN^{11/16} X H 19 IN^{3/16}

230741 + 230742 + 230743
NIVEAU 1 + 2 + 3
 LEVEL 1+2+3
 L 44 X P 68,2 X H 48,8 CM
 W 17 IN^{5/16} X D 26 IN^{7/8} X H 19 IN^{3/16}

SUPPORTS À FIL ROUNDS ROUND TRAYS

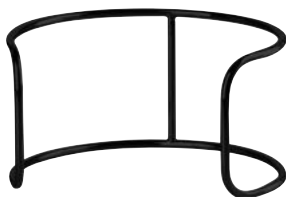

SUPPORT 230745
ROUND BAS - LOW LEVEL
 ROUND STAND Ø 25 CM X H 13 CM
 Ø 9 IN^{13/16} X H 5 IN^{1/8}

230746
HAUT - HIGH LEVEL
 Ø 25 CM X H 26 CM
 Ø 9 IN^{13/16} X H 10 IN^{1/4}

GRÈS CARBONE⁽¹⁾
 GREY STONEWARE



SALADIER 234564
BAS Ø 25,4 X 7 CM - 2,4 L
 SALAD Ø 10 IN X 2 IN^{3/4} - 80 OZ^{1/8}
 BOWL



PANIÈRES 230750
 BREAD BASKETS **INDIVIDUELLE-INDIVIDUAL**
 Ø 18 CM X 6 CM
 Ø 7 IN^{1/16} X 2 IN^{3/8}

230748
RONDE-ROUND
 Ø 32 CM X H 8 CM
 Ø 12 IN^{5/8} X H 3 IN^{1/8}

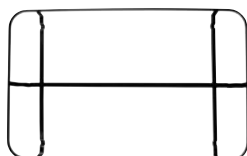

CADRE ACIER 230744
POUR SUPPORT L 55,5 X P 35 X H 4,5 CM
RECTANGULAIRE⁽¹⁾ W 21 IN^{7/8} X D 13 IN^{3/4} X H 1 IN^{3/4}
 STEEL FRAME FOR STAND

MÉLAMINE BOIS⁽²⁾
 WOOD MELAMINE TRAY



PLATEAUX 234546
 TRAYS **GN1/1**
 53,5 X 32,5 CM
 20 IN^{7/8} X 12 IN^{13/16}

MÉLAMINE PIERRE⁽²⁾
 STONE MELAMINE TRAY



234547
GN1/1
 53,5 X 32,5 CM
 20 IN^{7/8} X 12 IN^{13/16}

ACIER 18/10 NEWPORT
FINITION MIROIR
 SERVING TRAY STAINLESS STEEL
 18/10 MIRROR FINISHED



238962
GN1/1
 53,5 X 32,5 CM
 20 IN^{7/8} X 12 IN^{13/16}

VERRE ÉPAISSEUR 0,6 CM
 TEMPERED GLASS THICKNESS IN^{1/4}



230752
GN1/1
 53,5 X 32,5 CM
 20 IN^{7/8} X 12 IN^{13/16}

MÉLAMINE BOIS⁽²⁾
 WOOD MELAMINE TRAY



PLATEAUX RONDS 234561
 ROUND TRAYS Ø 32 CM
 12 IN^{5/8}

MÉLAMINE PIERRE⁽²⁾
 STONE MELAMINE TRAY



234562
 Ø 32 CM
 12 IN^{5/8}

PORCELAINE MODULO
 MODULO PORCELAIN
 PIE/PIZZA PLATE, FLAT



136524
 Ø 32 CM
 12 IN^{5/8}

(1) Compatible lave-vaisselle, Compatible micro-ondes
 Dish washer safe, Micro-wave safe

(2) Compatible lave-vaisselle, NON compatible micro-ondes
 Dish washer safe, DONT USE with micro-wave safe



BOARDS

CHÊNE
OAK



PLANCHE RONDE 242942
ROUND BOARD 29,4 CM - 11 IN^{9/16}
EPAISSEUR - 2 CM
THICKNESS - IN^{9/16}

NOYER
WALNUT



PLANCHE RONDE 242946
ROUND BOARD 29,4 CM - 11 IN^{9/16}
EPAISSEUR - 2 CM
THICKNESS - IN^{9/16}

COMPATIBLE AVEC
LA CLOCHE EVENTO 239771
COMPATIBLE WITH
EVENTO DOME COVER



PLANCHE BAHIA 242941
BAHIA BOARD 35 X 21 CM - 13 IN^{3/4} X 8 IN^{1/4}
EPAISSEUR - 2 CM
THICKNESS - IN^{9/16}



PLANCHE BAHIA 242945
BAHIA BOARD 35 X 21 CM - 13 IN^{3/4} X 8 IN^{1/4}
EPAISSEUR - 2 CM
THICKNESS - IN^{9/16}



PLANCHE CARREE 242940
SQUARE BOARD 36,7 X 30 CM - 14 IN^{7/16} X 11 IN^{13/16}
EPAISSEUR - 2 CM
THICKNESS - IN^{9/16}



PLANCHE CARREE 242944
SQUARE BOARD 36,7 X 30 CM - 14 IN^{7/16} X 11 IN^{13/16}
EPAISSEUR - 2 CM
THICKNESS - IN^{9/16}



PLANCHE ALLONGEE 242939
LONG BOARD 50 X 21 CM - 19 IN^{11/16} X 8 IN^{1/4}
EPAISSEUR - 2 CM
THICKNESS - IN^{9/16}



PLANCHE ALLONGEE 242943
LONG BOARD 50 X 21 CM - 19 IN^{11/16} X 8 IN^{1/4}
EPAISSEUR - 2 CM
THICKNESS - IN^{9/16}

PLANCHES LES ESSENCES

MADE IN FRANCE



DEGRENE
1821

ACCESSORIES



PLANCHE À PAIN 202854
BAMBOU AVEC GN 1/1
RÉCUPÉRATEUR DE MIETTES 53 X 32,5 CM
 20 IN^{7/8} X 12 IN^{13/16}
 BAMBOO BREAD BOARD
 WITH CRUMB TRAY



COUTEAU À PAIN 229516
L'ECONOME BY STARCK® 24 CM - 9 IN^{7/16}
POSITIONNABLE
DANS LA PLANCHE
L'ECONOME BY STARCK®
 BREAD KNIFE FITS IN A SLOT IN
 THE BREAD BOARD



SALADIER 202625
PORCELAINE 23 CM - 9 IN^{1/16}
EVENTO BLANC H : 9,6 CM - 3 IN^{3/4}
 WHITE EVENTO CONTENANCE : 2 L
 SALAD BOWL CAPACITY : 67 OZ^{5/8}



SALADIER 142722
PORCELAINE 28 CM - 11 IN
MODULO H : 12 CM - 4 IN^{3/4}
 DEEP SALAD BOWL, LARGE CAPACITY : 2,5 L
 CONTENANCE : 84 OZ^{3/16}



PRÉSENTOIR 209381
À GÂTEAUX ROND Ø 25 CM - 9 IN^{13/16}
 ROUND APP/PIZZA/
 PRESENTATION STAND **209382**
 Ø 32 CM - 12 IN^{5/16}



CLOCHE 239769
EVENTO VERRE Ø 16 CM - 6 IN^{5/16}
 EVENTO
 DOME COVER **239770**
 Ø 23 CM - 9 IN^{1/6}
239771
 Ø 28 CM - 11 IN



SUPPORT COUVERTS 202633
DE SERVICE 21 X 10 X 5 CM
PORCELAINE 8 IN^{1/4} X 3 IN^{15/16} X 1 IN^{15/16}
 SERVING
 CUTLERY DISPLAY
 WHITE PORCELAIN



ETIQUETTE 202632
PORCELAINE 10 X 5 CM
AVEC AIMANT 3 IN^{15/16} X 1 IN^{15/16}
+ SUPPORT ACIER
 PORCELAIN STICK +
 STAINLESS STEEL STAND
 WITH MAGNET

MÉLAMINE BOIS⁽²⁾
 WOOD MELAMINE TRAY



(1) PLANCHA 234559
AVEC MANCHE 17,5 X 45 CM
 BOARD 6 IN^{7/8} X 17 IN^{11/16}

MÉLAMINE PIERRE⁽²⁾
 STONE MELAMINE TRAY



234560
 17,5 X 45 CM
 6 IN^{7/8} X 17 IN^{11/16}



CISEAUX ✪ 204496
À GÂTEAUX ✪ 101494
 PASTRY
 SCISSORS/TONG 20 CM - 7 IN^{7/8}



PINCE À SERVIR ✪ 204499
 SERVING TONG ✪ 184355
 29,5 CM - 11 IN^{5/8}



PINCE À PAIN ✪ 204498
 BREAD TONG ✪ 101492
 23 CM - 9 IN^{1/16}



LOUCHE ✪ 153193
 SOUP LADLE
ASTRÉE MIROIR
 29,7 CM - 11 IN^{11/16}

(1) Planche de présentation uniquement, ne pas faire de découpe
 Presentation board, dont cut on it

(2) Compatible lave-vaisselle, NON compatible micro-ondes
 Dish washer safe, DONT USE with micro-wave

ACCESSOIRES

PIERRE DE LUNE
MOONSTONE
Porcelaine - Porcelain



SALADIER 239325
BOWL
28 CM - 11 IN
4L - 135 OZ^{1/4}

DUNE
BEIGE DUNE
Grès - Stoneware



235223
28 CM - 11 IN
4L - 135 OZ^{1/4}

BLEU DE ROCHE
BLUE STONE
Grès - Stoneware



235222
28 CM - 11 IN
4L - 135 OZ^{1/4}

ONYX
BLACK ONYX
Grès - Stoneware



240499
28 CM - 11 IN
4L - 135 OZ^{1/4}

ARGILE VERTE
GREEN CLAY
Grès - Stoneware



PLANCHE 242054
RECTANGULAIRE
RECTANGULAR
BOARD
35 x 21 CM
13 IN^{3/4} x 8 IN^{1/4}



242056
35 x 21 CM
13 IN^{3/4} x 8 IN^{1/4}



242052
35 x 21 CM
13 IN^{3/4} x 8 IN^{1/4}



237206
25 X 13,5 CM
9 IN^{13/16} X 5 IN^{5/16}



234949
25 X 13,5 CM
9 IN^{13/16} X 5 IN^{5/16}



PLANCHE 242055
RONDE
ROUND
BOARD
29 CM - 11 IN^{7/16}



242057
29 CM - 11 IN^{7/16}

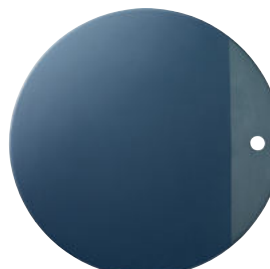

242053
29 CM - 11 IN^{7/16}

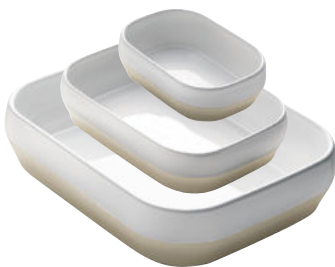

PLAT 241835
GRAND MODÈLE
LARGE DISH
31,8 x 25 x 7,4 CM
12 IN^{1/2} x 9 IN^{13/16} x 2 IN^{15/16}

PLAT 241834
MOYEN MODÈLE
MEDIUM DISH
22,8 x 16,2 x 5,4 CM
9 IN x 6 IN^{3/8} x 2 IN^{1/8}

PLAT 241833
PETIT MODÈLE
SMALL DISH
15,5 x 10,7 x 4,4 CM
6 IN^{7/8} x 4 IN^{3/16} x 1 IN^{3/4}



237595
31,8 x 25 x 7,4 CM
12 IN^{1/2} x 9 IN^{13/16} x 2 IN^{15/16}

237594
22,8 x 16,2 x 5,4 CM
9 IN x 6 IN^{3/8} x 2 IN^{1/8}

237593
15,5 x 10,7 x 4,4 CM
6 IN^{7/8} x 4 IN^{3/16} x 1 IN^{3/4}



56,5 CM - 22 IN^{1/4}

56,5 CM - 22 IN^{1/4}

56,5 CM - 22 IN^{1/4}

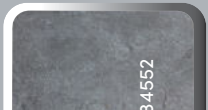
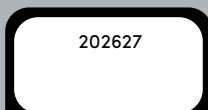
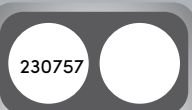

202865

202869

202864

36 CM - 14 IN^{3/16}



41 CM - 16 IN^{1/8}



215722



216144

35,5 CM - 14 IN

35,5 CM - 14 IN



230745 + 230750

230746 + 230748

68,2 CM - 26 IN^{7/8}



230744 +

PLAN



242055

29 CM - 11 IN^{7/16}



239325

Ø 28 CM
Ø 11 IN



240499

234562
Ø 32 CM - 12 IN^{5/8}

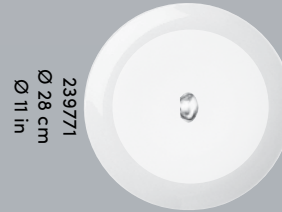

239771
Ø 28 cm
Ø 11 in

Ø 32 cm
Ø 12 IN^{5/8}

209382

35.5 CM - 14 IN

20 CM - 7 IN^{7/8}



237593

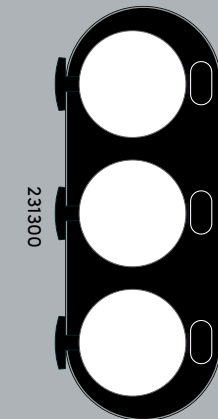

231300

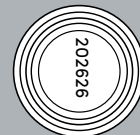

202626

32 CM - 12 IN^{5/8}



231303

20 CM
7 IN^{7/8}

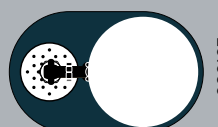

231303

20 CM
7 IN^{7/8}

50 CM - 19 IN^{11/16}

CHAFING DISH

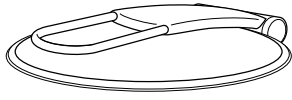

COUVERCLE AVEC GOUTTIÈRE **203470**
ACIER ET VERRE TREMPÉ Ø 33 CM - Ø 13 IN
LID WITH STAINLESS STEEL
GUTTER,
TEMPERED GLASS

KIT SAV VÉRINS **217435**
POUR CHAFING DISH
REPLACING KIT FOR
CHAFING DISH CYLINDER

JOINT POUR CHAFING DISH **230050**
SEAL FOR CHAFING DISH

MODULE FROID REFRIGERATED UNIT



BAC PLASTIQUE **202866**
PLASTIC TRAY 56 X 35,5 X 8 CM
22 IN^{1/16} X 14 IN X 3 IN^{1/8}

235357
29,5 X 35,6 CM
11 IN^{5/8} X 14 IN

PIÈCES DÉTACHÉES

URNE À JUS DE FRUITS FRUIT JUICE URN

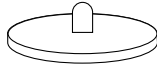

COUVERCLE URNE 202881
ACIER 18-10 **FINITION MIROIR**
LID FOR STAINLESS MIRROR FINISH
DISPENSER 18-10 Ø 17,9 CM
7 IN^{1/16}

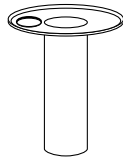

TUBE ACIER POUR 202884
GLACE Ø 9 CM - 3 IN^{9/16}
ICE TUBE
STAINLESS STEEL

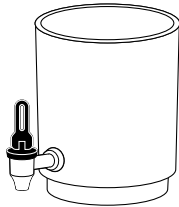

FÛT CYLINDRIQUE 202883
URNE 5 L - 169 OZ^{1/16}
CONTAINER FOR Ø 17,7 CM X H 25,5 CM
DISPENSER Ø 6 IN^{15/16} X H 10 IN^{1/16}

ROBINET ACIER 214724
ABS NOIR
STAINLESS STEEL
FAUCET BLACK

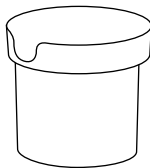

BASE ACIER 202890
18-10 URNE **FINITION MIROIR**
STAINLESS STEEL MIRROR FINISH
STAND FOR Ø 17,6 CM - H 19 CM
DISPENSER 18-10 6 IN^{15/16} X 7 IN^{1/2}

202889
FINITION BROSSÉE
BRUSHED FINISH
Ø 17,6 CM - H 19 CM
6 IN^{15/16} X 7 IN^{1/2}



GRILLE ACIER 045963
POUR GOUTTES - 18/10 Ø 9 CM
STAINLESS STEEL GRID Ø 3 IN^{9/16}
DROP COLLECTOR



SOCLE NOIR ACRYLIQUE URNE 230758
STAND FOR BLACK DISPENSER 20 X 32 CM
7 IN^{7/8} X 12 IN^{5/8}
ÉPAISSEUR : 2 CM
THICKNESS: 13/16 IN

DISTRIBUTEUR À CÉRÉALES CEREAL DISPENSER



COUVERCLE 213078
DISTRIBUTEUR CEREALES Ø 12,5 CM
ACIER FINITION MIROIR - 18/10 Ø 4 IN^{15/16}
LID FOR CEREAL DISPENSER,
STAINLESS STEEL,
MIRROR FINISH

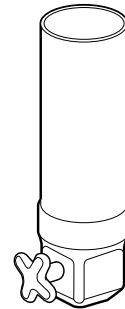

FUT CYLINDRIQUE 213076
AVEC AILETTE ET POIGNEE P 16,1 X H 42 CM
DISTRIBUTEUR CEREALES D 6 IN^{5/16} X H 16 IN^{9/16}
BARREL + HANDLE + ROLLING TAP
FOR CEREAL DISPENSER

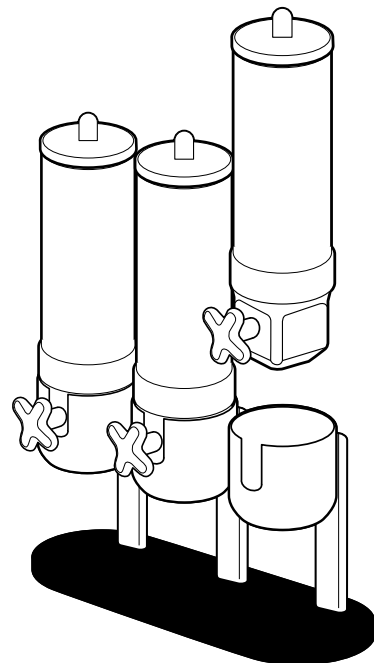

X3

X1

BASE + TUBE + SOCLE 231302
DISTRIBUTEUR À CEREALES L 50 X H 27,5 CM
STAINLESS STEEL STAND + TUB L 19 IN^{11/16} X H 29 IN^{3/4}
+ ACRYLIC STAND FOR CEREAL DISPENSER

231301
L 19 X H 27,5 CM
L 7 IN^{1/2} X H 29 IN^{3/4}





Pensée initialement pour répondre aux besoins des collectivités, la nouvelle collection GD revisite avec finesse ses gammes de couverts et platerie Made In France et celles de vaisselle Made in Europe . Chaque pièce évoque discrètement ce mélange entre héritage et exigences contemporaines : des formes simples, des détails subtils, et un usage fonctionnel. Le tout avec le marquage DEGRENNE, véritable gage de qualité. En mariant judicieusement des formes issues de nos archives à une approche moderne, cette collection s'inscrit dans une démarche éco-responsable et devient un choix idéal pour tout établissement à la recherche d'une touche de rétro.

Originally designed to meet the needs of communities, the new GD collection delicately reimagines its ranges of Made In France cutlery and tableware, as well as those of Made in Europe dinnerware. Each piece subtly reflects the blend of heritage and contemporary requirements: simple shapes, subtle details, and functional use. All of this comes with the DEGRENNE branding, a true mark of quality.

By skillfully combining shapes from our archives with a modern approach, this collection embraces an eco-responsible approach and becomes an ideal choice for establishments seeking a touch of retro.

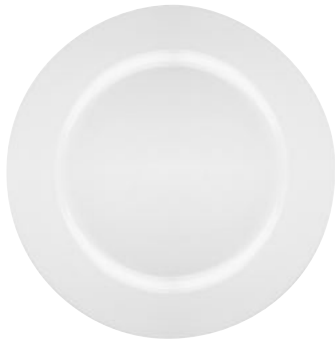

ASSIETTE 223287
PLATE 30 CM - 11 IN^{7/8}
 ROUND
 DINNER PLATE **223286**
 26,5 CM - 10 IN^{3/7}

223285
 20 CM - 7 IN^{7/5}



ASSIETTE 223288
CREUSE 19 CM - 7 IN^{1/2}
 ROUND
 SOUP PLATE



ASSIETTE 223294
À PIZZA 30 CM - 11 IN^{7/8}
 PIZZA PLATE



ASSIETTE 223363
À PAIN 15 CM - 5 IN^{7/8}
 ROUND
 BREAD & BUTTER
 PLATE



MUG 223293
 MUG 30 CL - 10 OZ



TASSE À THÉ 223291
 COFFEE/TEA CUP 20 CL - 6 OZ^{3/4}

SOUCOUE À THÉ 223292
 COFFEE/TEA SAUCER 15 CM - 5 IN^{7/8}



TASSE À CAFÉ 223289
 DEMITASSE CUP 10 CL - 3 OZ^{3/8}

SOUCOUE À CAFÉ 223290
 DEMITASSE SAUCER 12 CM - 4 IN^{3/4}



VITAL





ASSIETTE 194112
PLATE 26 CM - 10 IN^{1/4}
 DINNER PLATE



ASSIETTE 194115
DESSERT 20 CM - 7 IN^{7/8}
 ROUND
 DESSERT
 PLATE



ASSIETTE 194113
CREUSE 22 CM - 8 IN^{11/16}
 ROUND
 SOUP PLATE **194114**
 19 CM - 7 IN^{1/2}



ASSIETTE 194116
À PAIN 15 CM - 5 IN^{7/8}
 ROUND
 BREAD & BUTTER
 PLATE



PLAT ROND PLAT 194110
 ROUND DISH 30 CM - 11 IN^{13/16}



PLAT OVALE 194122
 OVAL DISH 36 CM - 14 IN^{3/16}



PLAT 194121
À CAKE 22 CM - 8 IN^{11/16}
 RECTANGULAR
 CAKE DISH

194123
 28 CM - 11 IN



BOL 194120
 BOWL 13 CM - 5 IN^{1/8}



SAUCIERE 194139
 SAUCE JUG 20 CL - 6 OZ^{3/4}



CREMIER 194137
 CREAM JUG 10 CL - 3 OZ^{3/8}



TASSE À ESPRESSO 194125
 ESPRESSO CUP 9 CL - 3 OZ^{1/16}



TASSE À CAFÉ 194126
 DEMITASSE CUP 18 CL - 6 OZ^{1/16}



TASSE À THÉ 194127
 COFFEE/TEA CUP 26 CL - 8 OZ^{13/16}

SOUCOUPE À ESPRESSO 194129
 ESPRESSO SAUCER 13 CM - 5 IN^{1/8}

SOUCOUPE À CAFÉ 194130
 DEMITASSE SAUCER 14 CM - 5 IN^{1/2}

SOUCOUPE À THÉ 194131
 COFFEE/TEA SAUCER 16 CM - 6 IN^{7/16}



GLORIA





ASSIETTE 109343
PLATE 26,5 CM - 10 IN^{3/7}
ROUND
DINNER PLATE 109338
24 CM - 9 IN^{4/9}
109340
19 CM - 7 IN^{1/2}



ASSIETTE 109339
CREUSE 22 CM - 8 IN^{2/3}
ROUND
SOUP PLATE



ASSIETTE 109344
À PAIN 16 CM - 6 IN^{2/7}
ROUND
BREAD & BUTTER
PLATE



TASSE À DÉJEUNER 054303
BREAKFAST CUP 28 CL - 9 OZ^{7/16}

SOUCOUPE À DÉJEUNER 054308
BREAKFAST SAUCER 16 CM - 6 IN^{2/7}



TASSE À THÉ 054301
COFFEE/TEA CUP 16 CL - 5 OZ^{7/16}

SOUCOUPE À THÉ 054302
COFFEE/TEA SAUCER 15 CM - 5 IN^{7/8}



TASSE À MOKA 109341
MOKA CUP 10 CL - 3 OZ^{3/8}

SOUCOUPE À MOKA 109342
MOKA SAUCER 13 CM - 5 IN^{1/8}



UNISET





169511
FOURCHETTE DE TABLE
TABLE FORK
19,9 CM - 7 IN^{13/16}



169513
COUTEAU À STEAK
MONOBLOC LAME SCIE
STEAK KNIFE SOLID HANDLE SERRATED
22,3 CM - 8 IN^{3/4}



169510
CUILLÈRE DE TABLE
TABLE/PASTA SPOON
20,1 CM - 7 IN^{5/16}



184372
FOURCHETTE À DESSERT/POISSON
DESSERT/SALAD/FISH FORK
17,9 CM - 7 IN^{7/16}



184374
CUILLÈRE À DESSERT
DESSERT/SOUP SPOON, OVAL
18 CM - 7 IN^{11/16}



184371
COUTEAU À DESSERT
MONOBLOC LAME UNIE
DESSERT KNIFE SOLID HANDLE
19,8 CM - 7 IN^{13/16}



169512
CUILLÈRE À CAFÉ
COFFEE/TEA SPOON
13,6 CM - 5 IN^{3/8}

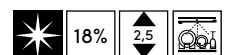

AMAZONE





193762
FOURCHETTE DE TABLE
TABLE FORK
20 CM - 7 IN^{7/8}



193764
COUTEAU DE TABLE
MONOBLOC LAME SCIE
TABLE KNIFE SOLID HANDLE SERRATED
23,2 CM - 9 IN^{7/8}



193761
CUILLÈRE DE TABLE
TABLE/PASTA SPOON
20,2 CM - 7 IN^{5/16}



195773
FOURCHETTE À DESSERT
DESSERT/SALAD FORK
17,9 CM - 7 IN^{7/16}



195772
CUILLÈRE À DESSERT
DESSERT/SOUP SPOON, OVAL
17,8 CM - 7 IN



195774
COUTEAU À DESSERT
MONOBLOC LAME UNIE
DESSERT KNIFE SOLID HANDLE
20,2 CM - 7 IN^{5/16}



193763
CUILLÈRE À CAFÉ
COFFEE/TEA SPOON
13,6 CM - 5 IN^{3/16}

CASSIOPEE





PLATEAU COMPARTIMENTÉ 240688
COMPARTIMENTALISED SERVING TRAY 39,5 X 29,5 CM - 15 IN³/₁₆ X 11 IN⁵/₈



PLATEAU ALVÉOLÉ MATERNELLE 242663
ALVEOLE TRAY FOR NURSERY SCHOOL 33,5 X 24,6 CM - 13 IN³/₁₆ X 9 IN¹¹/₁₆

UNI





PLATEAU 003929
RECTANGULAIRE AVEC ANSES 45 X 31,5 CM - 17 IN^{11/16} X 12 IN^{3/8}
 RECTANGULAR SERVING TRAY WITH HANDLES



PLATEAU 003930
RECTANGULAIRE SANS ANSES 45 X 31,5 CM - 17 IN^{11/16} X 12 IN^{3/8}
 RECTANGULAR SERVING TRAY WITHOUT HANDLES



PLAT 003947
OVALE 46 X 31 CM - 18 IN^{11/8} X 12 IN^{3/16}
 OVALE DISH

003945
 39 X 25 CM - 15 IN^{3/8} X 9 IN^{13/16}

003944
 34 X 23 CM - 13 IN^{3/8} X 9 IN^{1/16}



PLAT 003948
À POISSON 60 X 27 CM - 23 IN^{5/8} X 10 IN^{5/8}
 FISH DISH



PLAT 003951
ROND PLAT 33 CM - 13 IN
 ROUND FLAT DISH



PLAT 003940
À GRATIN 45 X 31,5 CM - 17 IN^{11/16} X 12 IN^{3/8}
RECTANGULAIRE
 RECTANGULAR GRATIN DISH

003941
 37 X 25 CM - 14 IN^{3/16} X 9 IN^{13/16}



SOUPIÈRE 003971
SANS COUVERCLE 24 X 9,5 CM - 9 IN^{7/16} X 3 IN^{3/4}
 SOUP TUREEN WITHOUT LID

003970
 22 X 9,5 CM - 8 IN^{11/16} X 3 IN^{3/4}
 220 CL - 74 OZ^{3/8}

003969
 20 X 8,5 CM - 7 IN^{7/8} X 3 IN^{3/8}
 170 CL - 57 OZ^{1/2}



UNI



POT À VERSER 003968

EMPILABLE 2 L - 12 X 17 CM - 67 OZ^{5/8} - 4 IN^{3/4} X 6 IN^{11/16}

STACKABLE

WATER JUG 003967

1,5 L - 10,5 X 16 CM - 50 OZ^{3/4} - 4 IN^{1/8} X 6 IN^{5/16}

003966

1 L - 9,5 X 13,5 CM - 33 OZ^{13/16} - 3 IN^{3/4} X 5 IN^{5/16}



PLATEAU 044811

LIMONADIER 40 CM - 15 IN^{3/4}

ROUND SERVING
TRAY

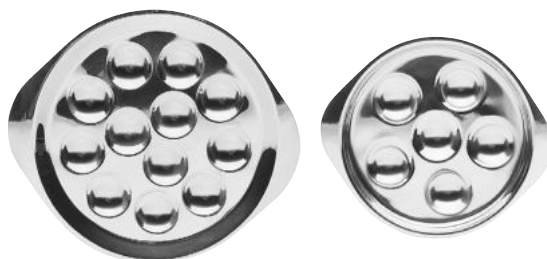

PLAT À ESCARGOTS 003935
12 PLACES 20 CM - 9 IN^{1/16}
 SNAIL DISH 12 HOLES

6 PLACES 003934
 SNAIL DISH 6 HOLES 14,5 CM - 6 IN^{1/2}



RAMEQUIN 003975
 RAMEKIN 8 CM - 3 IN^{1/8}
 19 CL - 6 OZ^{7/16}



PLAT 003939
À GRATIN 38 X 28 CM - 14 IN^{15/16} X 11 IN

OVALE
OVALE 003937
 GRATIN DISH 24 X 15 CM - 9 IN^{7/16} X 5 IN^{7/8}



CORBILLE À PAIN 003919
CANNELÉE 31 X 21 CM - 12 IN^{3/16} X 8 IN^{1/4}

FLUTED
BREAD BASKET 003918
 26 X 18 CM - 10 IN^{1/4} X 7 IN^{1/16}



UNI



POT À VERSER 004042
WATER JUG 2 L - 12,5 X 19 CM - 67 OZ^{5/8} - 4 IN^{5/16} X 7 IN^{1/2}

004041
1,5 L - 11 X 17,5 CM - 50 OZ^{3/4} - 4 IN^{5/16} X 6 IN^{7/8}

004040
1 L - 9,5 X 15 CM - 33 OZ^{13/16} - 3 IN^{3/4} X 5 IN^{7/8}

004039
0,5 L - 7 X 10 CM - 16 OZ^{15/16} - 2 IN^{3/4} X 5 IN^{15/16}



SEAU À GLACE 004047
ICE BUCKET 0,5 L - 10 CM - 16 OZ^{15/16} - 3 IN^{15/16}



SEAU À CHAMPAGNE 154148
SANS ANSE 300 CL - 19 CM - 101 OZ^{7/16} - 7 IN^{1/2}
CHAMPAGNE BUCKET
WITHOUT HANDLE **160899**
1 L - 13 CM - 33 OZ^{13/16} - 5 IN^{1/8}





**FINITION MÉTAL ARGENTÉ - ARGENTURE
CLASSE 1 - 33 MICRONS (POUR LES
ARTICLES À USAGE FRÉQUENT)**
SILVER PLATED FINISH - CLASS 1 SILVERPLATING -
33 MICRONS



ARGENTURE QUALITÉ HÔTELIÈRE-10 MICRONS
SILVER PLATED HOTEL QUALITY- 10 MICRONS



FINITION MIROIR
MIRROR FINISH



FINITION SATINÉE
SATIN FINISH



FINITION CONTRASTE
CONTRAST FINISH



FINITION VINTAGE
VINTAGE FINISH



FORGÉ
FORGED

18%

18-10

ACIER INOXYDABLE
STAINLESS STEEL



EPAISSEUR FOURCHETTE DE TABLE
THICKNESS TABLE FORK



REVÊTEMENT PVD
PVD COATING



PORCELAINE
PORCELAIN



AIMANTÉ
WITH MAGNET



GRÈS
STONEWARE



EMPILABILITÉ
STACKABLE



RÉSISTE AUX CHOCS
SHOCK RESISTANT



RÉSISTE AUX TACHES
STAIN RESISTANT



VERRE
GLASS



SHQ/ SODOCALCIQUE
HAUTE QUALITÉ
HIGH QUALITY SODA - LIME



CRISTALLIN HAUTE QUALITÉ
HQ LOW LEAD CRYSTAL



VERRE SOUFFLÉ BOUCHE TEINTÉ
DANS LA MASSE
HAND-BLOWN INTEGRALLY DYED GLASS



1000 CYCLES GARANTIS MINIMUM
1000 WASH CYCLES GUARANTEED



CRISTALLIN
CRYSTALLINE



SOUFFLÉ MÉCANIQUE
MACHINE BLOWN



FINESSE DU BUVANT
THICKNESS OF THE RIM



LÉGÈRETÉ
LIGHTNESS



GARANTIE MICRO-ONDES
MICROWAVE SAFE



GARANTIE LAVE-VAISSELLE
DISHWASHER SAFE



GARANTIE CONGÉLATEUR
FREEZER SAFE



GARANTIE FOUR
OVEN SAFE



**JUSQU'À ÉPUISEMENT
DES STOCKS**
UNTIL STOCK LAST

MADE IN FRANCE

FABRIQUÉ EN FRANCE
MADE IN FRANCE

MADE IN EUROPE

FABRIQUÉ EN EUROPE
MADE IN EUROPE

FRANCE USA

SIEGE SOCIAL/HEAD OFFICE
SERVICE CLIENTS/CUSTOMER SERVICES

Rue Guy Degrenne - BP 50056
14502 Vire cedex
TEL : +33 (0)2 31 66 44 15

OTHER COUNTRIES
TEL : +33 (0)2 31 66 44 00

infohotel@degrenne.fr

FILIALE USA/US SUBSIDIARY

DNA/DEGRENNÉ NORTH AMERICA INC.
301 OXFORD VALLEY ROAD SUITE 1903B, YARDELY, PA 19067
NEW BRUNSWICK, NJ 08901 - USA

TEL : 732 565 0820
FAX : 732 565 0828

csvr.dna@degrennenorthamerica.com
www.degrenneparis.us

SHOWROOM (BY APPOINTMENT)
NEW YORK (41 MADISON)

www.pro.degrenne.fr

FRANCE
infohotel@degrenne.fr
Tel : +33 (0)2 31 66 44 15

OTHER COUNTRIES/OTROS PAISES
infohotel@degrenne.fr
Tel : +33 (0)2 31 66 44 00

FILIALE USA/US SUBSIDIARY
csrv.dna@degrennenorthamerica.com
Tel : 732 565 0820

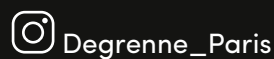

www.pro.degrenne.fr