

# CATALOG

ISSUE 50 | 2023



**AQUA**

 **stalgast**  
power of gastronomy



Pro-ecological technologies



Polish production,  
European quality



>7500 products  
in stock



20 000  
pallet spaces



More than 600  
employees



98% product  
availability

## We have been supporting gastro businesses in Poland and abroad for over 30 years!

We are practitioners who know power of gastronomy. Your challenges are our challenges, too, so we offer solutions to help you achieve your goal - with us, you'll get the satisfaction and take pride in your work.

Together with restaurant owners, distributors and our partners, we are changing the catering market. In times of uncertainty, we believe that this is a job for **strong, dynamic and proven players**.

**We are a family business.** We have been sharing our knowledge and experience for **two generations**. This is also how we approach business - as partners, based



on mutual **trust and support**. Working with us, you can count on facing together: the daily and long-term challenges of the catering business: through kitchen equipment, selection of furniture or accessories, to professional service at every stage of the purchase.

Satisfaction with well-prepared dishes and, as a result, the satisfaction of our clients is our greatest motivation. After all, as a leader, we feel responsible not only for our customers, but also for the entire catering industry, setting trends and new directions of development.

**We are the Central European market leader and the largest HoReCa company in the local market. You can count on us.**

In 2008, we launched a factory of catering equipment and accessories in Radom, and we are successively developing our offer. Production is carried out in a modern machinery park, which gives us great opportunities for rapid implementation and precise individualization of orders.

We manufacture stainless steel furniture, dishwashers, heating lines, serving lines and small setting equipment. We also manufacture plastic accessories (such as dishwasher baskets and catering boards).

## Polish manufacturing



Modern Factory of Catering Equipment in Radom.

In 2018, we launched the industry's most modern Logistics Center, where distribution to domestic and foreign customers is organized using the latest processes and technologies.

- Capacity of almost 20 000 pallets
- Same-day handling time
- More than 7500 products in stock
- 10 ramps



## Stalgast Modern Logistics Center

### We support our clients at every stage of the investment

#### Design studio



#### Service



#### Expert advice



#### Showrooms partner



We operate in Poland through more than **500 distributors** - our Business Partners

Globally, we work with **220 partners** in more than **40 countries**



[stalvast.eu](http://stalvast.eu)



[export@stalvast.com](mailto:export@stalvast.com)

# We support gastronomy in ECO style

We have been taking care of what is important for the catering market for years. We support and offer equipment tailored to a wide variety of establishments. However, our commitment goes much further. We want to have a real impact both on the development of your business as well as on environmental protection. That is why in our daily work we introduce solutions that allow you to be ECO on many levels.



## Plastic reduction

In 99% of cases, we dispense with the film that coats the sheet during production and delivery. As a result, we are reducing its use.



## Energy-efficient production

The professional cutting laser allows us to reduce the consumption of technical gases and abrasives, and the automatic bending centre does not require manual refitting, making the production process faster.



## Economical solutions

We look for clever technologies - using the new under-burner bowl in our freestanding kitchens increases the efficiency of gas appliances by 4 to 6%.



## Green technologies

We are raising awareness of energy saving by providing a wide range of induction appliances. Induction heats only the bottom of the cookware and does not work when not in contact with it, heat does not escape and electricity consumption is reduced.



## Thermal insulation materials

We make sure that cooking is efficient and economical at the same time. The thermo-insulation used in the ovens protects the chamber from heat loss, so you can keep your food at the right temperature without consuming extra energy.



## Reuse of materials

Dishwasher baskets, boards and other components that do not meet the quality standards are reprocessed by us into a new product. This prevents the waste of plastic.



# New products are on pages:

**NEW**

- Electric ice crusher ..... 211
- Module of 2 drawers  
for refrigerated tables GN 1/1 ..... 308
- Chest freezer ..... 311
- Chest freezer with stainless steel lid ..... 311
- Set of wheels for chest freezers ..... 311
- Plastic basket for chest freezers ..... 311
- Screw-joined furniture  
for self-assembly ..... 315-318
- Welded furniture ..... 319-321
- Wall table without shelf ..... 315
- Wall table with shelf ..... 315
- Table with a single-chamber basin ..... 316
- Table with a single-chamber basin ..... 316
- Hanging cabinet (swinging door) ..... 316
- Hanging cabinet (sliding door) ..... 316
- Single adjustable hanging shelf ..... 317
- Double adjustable hanging shelf ..... 317
- Storage rack solid shelves ..... 317
- Table with a single-chamber sink with a shelf ..... 317
- Table with a single-chamber sink with a shelf ..... 318
- Table with a double chamber sink without a shelf ..... 318
- Table with a double chamber sink with a shelf ..... 318
- Wall table with sliding doors ..... 319
- Washbasin ..... 319
- Utility cabinet with washbasin ..... 320
- Storage cabinet (swinging door) ..... 320
- Pass-through cabinet (sliding doors) ..... 320
- Wall table with swing doors ..... 321
- Wall table with sliding doors ..... 321
- stalgest dishwashers ..... 335-440
- Hood-type dishwasher ..... 335-336
- Universal dishwasher power digital ..... 337
- Universal dishwasher ..... 338
- Glassware washer ..... 339
- Dishwasher set with base ..... 340



## EXPLANATIONS OF ICONOGRAPHIES AND ABBREVIATIONS USED IN THE CATALOG



power supply



INOX stainless steel



copper-coated



gas supply



INOX 18/0 stainless steel 18/0



Teflon-coated



heating with an electric heater



INOX 18/10 stainless steel 18/10



ceramic coating



fuel heating



PS made of polystyrene



tempered glass



can be used for induction



Al made of aluminum



crystal



cannot be used for induction



Cr made of chromed steel



marked glass



can be used on electric stoves



EPP made of polypropylene foam



can be stacked



can be used on gas stoves



PC made of polycarbonate



recommended for Sous Vide



can be used in microwave ovens



PE made of polyethylene



for self-assembly



dishwasher safe



PP made of polypropylene



order processing time within 72h



not dishwasher safe



NYLON made of nylon



use water with a hardness up to 6°dH as per German scale



recommended for convection ovens



SIL made of silicon



LED LED lighting



recommended for coffee machines



made of wood



14kW device power



compartment capacity



BPA free



25kg maximum load



in accordance with HACCP standards



intended for food contact



has certification



refrigeration device



or



oven compartment layout



freezing device



and



maximum height of the washed dish



static system



size WxDxH mm



double wall design



dynamic system



temperature range



recommended application in ovens



hinged door



maximum temperature



dishwasher basket 350x350 mm



opens from both sides



suitable for washing glassware



dishwasher basket 400x400 mm



sliding door



suitable for washing plates



dishwasher basket 500x500 mm



for gastronomic containers



suitable for washing pots



dishwasher basket 570x620 mm



for confectionery/  
bakery trays



adapted to wash  
GN 1/1 trays



Polish product  
Stalgast Radom

**NEW**

new product

Code	catalog number
No.	number
Ø	diameter
W	width
D	depth
H	height

L	length
V	volume
T	temperature
W (usable)	usable width
D (usable)	usable depth
H (usable)	usable height

N	rotation speed
S	performance
K	number of pieces in a box
M	mass
P	power
U	power supply

## TABLE OF CONTENTS

10-53

### COOKING LINE 700 AND FREESTANDING DEVICES

Cookers .....	14-23
Fry tops and grills .....	24-27
Fryers .....	28-29
Fries warmer .....	30
Pans .....	31-32
Wok .....	33
Bain-mariés .....	34
Pasta cookers .....	35-36
Neutral elements .....	37
Bases and accessories .....	38
Gas, induction and electric burner stoves .....	40-43
Gas induction and electric freestanding stoves .....	44-49
Freestanding grills .....	50
Freestanding fryer .....	51
Electric pan .....	52
Convection oven .....	53



54-64

### COOKWARE

Gredil pots .....	55
Premium pots, High pot with tap .....	56-57
Base for pots .....	57
Complementary accessories .....	57
Frying pans .....	58-63
WOK pans .....	58
Titanium-coated frying pans .....	59
Frying pans with non-stick coating .....	60-63
Comfort frying pans .....	60-61
Cast iron cookware .....	64



65-89

### KITCHEN UTENSILS

Buckets .....	66
Salad spinner .....	67
Bowls, tubs .....	68
Sieves, colanders .....	69-70
Serving accessories .....	71-75
Spatulas, whisks .....	75-76
Scoops, pitchers, measuring cups .....	77-78
Displays .....	80-81
Dispensers, racks for sauces .....	81
Tweezers, tongs, openers .....	82-83
Decoration knives and accessories .....	84
Can opener .....	85
Manual vegetable slicing appliances .....	85
Scales .....	86-88
Thermometers .....	89



90-111

### KNIVES AND CUTTING BOARDS

Knives and kitchen knife sets .....	91-105
Cleavers, mallets .....	94, 111
Magnetic strips .....	102
Sharpeners and steels .....	105-106
Kitchen scissors .....	110
Cutting boards .....	107-109
Butcher's block .....	110



112-140

### ACCESSORIES AND TABLEWARE

Cutlery .....	113-129
Steak and pizza cutlery .....	128
Porcelain and tableware .....	130-135
Spice kits .....	136
Spice grinders .....	138
Mortar with pestle .....	138
Bread baskets .....	139-140
Menu holder, table bin, stew kettles .....	138



141-166

### FOOD STORAGE AND TRANSPORT

GN containers .....	142-151
Transport containers .....	152-153
Transport thermal insulation containers .....	154-157
Pizza bags .....	155
Tray sealing machine .....	162
Packers and packer accessories .....	158-161
Transport and waiter carts .....	163-164
Racks .....	165-166



167-193

### BUFFET TABLEWARE

Heating lamps for dishes .....	168
Heaters, heater fuel .....	169-174
Soup cookers, kettles .....	175-176, 179
Pitchers, table vacuum flasks .....	180-181
Trays .....	185-188
Beverage cooling unit .....	183
Platters .....	184
Buffet columns .....	189
Finger food slate plates .....	190
Finger food utensils .....	191-193



194-199

### CATERING

Heating lamps .....	195
Hanging heating lamps .....	196
Heating table .....	196
Pyramid heating lamp .....	197
Catering furniture .....	198
Covers for catering furniture .....	199
Hotel poles .....	199



200-216

### BAR EQUIPMENT

Blenders .....	201-202
Cocktail shakers, bartender's openers, mortar, bartender strainers .....	204-205
Measuring cups, bartender spoons .....	205-206
Coolers, champagne buckets, bartending mats .....	207-208
Bartender dispensers, glass hanging racks .....	203, 209
Citrus juicers .....	203, 209-210
Ice makers, ice crushers .....	211-215
Bar refrigeration .....	216



**217-222 CAFE EQUIPMENT**



Coffee grinder . . . . . 218  
 Drip coffee maker . . . . . 219  
 Refrigerator for coffee milk . . . . . 219  
 Coffee maker table . . . . . 220  
 Pitcher, tamper, coffee grounds striker,  
 spice dispenser. . . . . 221-222

**223-233 BAKERY AND CONFECTIONERY EQUIPMENT**



Whipped cream siphon . . . . . 224  
 Ice cream portioners,  
 cuvettes, cups. . . . . 224  
 Bags, extrusion tips . . . . . 225  
 Baking paper, baking mats . . . . . 227  
 Hot chocolate appliance. . . . . 229  
 Confectioner's knives . . . . . 229  
 Cake and fruit platters. . . . . 230-231  
 Crème brûlée burner . . . . . 231  
 Planetary mixers . . . . . 232-233

**234-251 PIZZERIA EQUIPMENT**



Pizza ovens . . . . . 235-243  
 Spiral mixers . . . . . 245-247  
 Pizza shovels, spatulas. . . . . 248-249  
 Dough containers,  
 oven cleaning brushes . . . . . 249  
 Pizza trays, mesh. . . . . 249-250  
 Heat-insulated bags, containers . . . . . 250  
 Gloves . . . . . 250  
 Pizza refrigerated tables. . . . . 251

**252-258 MECHANICAL TREATMENT**



Potato peeler . . . . . 253  
 Slicing machines . . . . . 254  
 Steak makers and accessories. . . . . 255  
 Meat grinders. . . . . 255-256  
 Sausage fillers, sausage slicer. . . . . 257  
 Vegetable cutter . . . . . 258

**259-272 THERMAL TREATMENT**



Contact grills . . . . . 262-263  
 Deep fryers. . . . . 260, 264  
 Wafer crepe makers. . . . . 266  
 Grill hobs . . . . . 261, 264  
 Microwaves . . . . . 268-270  
 Heating display case . . . . . 267  
 Roller heater for sausages . . . . . 260  
 Chicken grill . . . . . 267  
 Adjustable bain-maries. . . . . 265  
 Toasters, salamander . . . . . 261  
 Induction cooker . . . . . 271  
 Sous Vide circulator . . . . . 272

**273-285 CONVECTION STEAM OVENS**



GASTRONOMIC convection steam ovens  
 Stalgast ClassicCook . . . . . 278  
 Stalgast SmartCook . . . . . 279-280  
 Accessories  
 for gastronomic ovens . . . . . 281-284

**286-311 COOLING**



Refrigerators  
 and freezers . . . . . 288-289, 302-304  
 Salad refrigerated counters,  
 cooling tops . . . . . 293-295, 300  
 Refrigerated and freezing  
 counters. . . . . 290-292, 296-297  
 Display cases . . . . . 298-299  
 Refrigeration 600x400 . . . . . 300  
 Bar tables and display cabinets . . . . . 305-309  
 Accessories for refrigerated  
 cabinets and tables . . . . . 308  
 Chest freezers, shock coolers . . . . . 309-311

**312-321 STAINLESS STEEL FURNITURE**



Working tables . . . . . 315, 319  
 Cupboards, cabinets,  
 shelves. . . . . 316-317, 231  
 Tables with sink and compartment  
 basin, washbasins. . . . . 316-319, 321  
 Storage racks. . . . . 317

**322-332 HYGIENE**



Workwear . . . . . 323-325  
 Safety cabinet . . . . . 327  
 Waste container. . . . . 327-329  
 Universal egg/knife sterilizer,  
 insecticide lamps . . . . . 330-331  
 Cleaning brushes. . . . . 331  
 Ozone generator,  
 disinfection unit - fogger . . . . . 332  
 Soap dispenser,  
 hand towel dispenser . . . . . 326

**333-355 DISHWASHING**

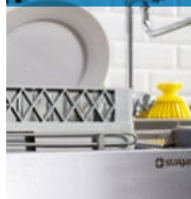

Dishwashers. . . . . 334-340  
 Racks for dishwashers . . . . . 342-343  
 Water softeners . . . . . 344-346  
 Touchless washbasins . . . . . 378  
 Water column for line 700. . . . . 351  
 Fillers and taps . . . . . 349-355  
 Organic waste shredders. . . . . 347  
 Drip trays for plates . . . . . 341





# COOKING LINE 700

## LINE 700

Cookers.....	14-23
Grills.....	24-27
Fryers.....	28-29
Fries warmer.....	30
Pans.....	31-32
Wok.....	33
Bain-maries.....	34
Pasta cookers.....	35-36
Neutral elements.....	37
Bases and accessories.....	38

## FREESTANDING DEVICES

Gas, induction and electric burner stoves.....	40-43
Gas induction and electric freestanding stoves.....	44-49
Freestanding grills.....	50
Freestanding fryer.....	51
Electric pan.....	52
Convection oven.....	53



# COOKING TECHNOLOGY COMPARISON

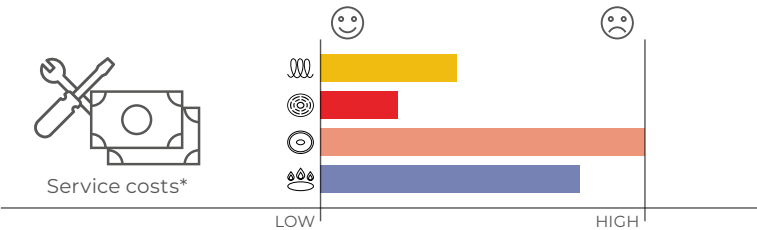
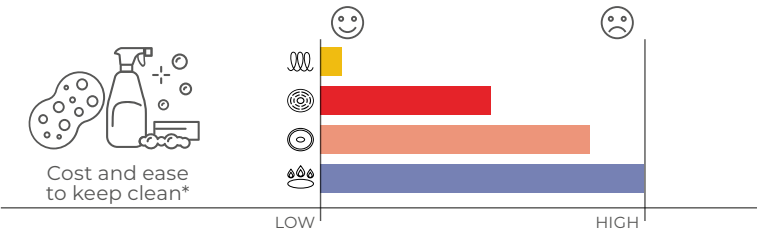
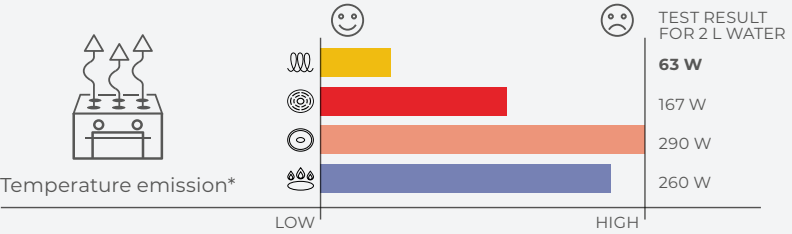
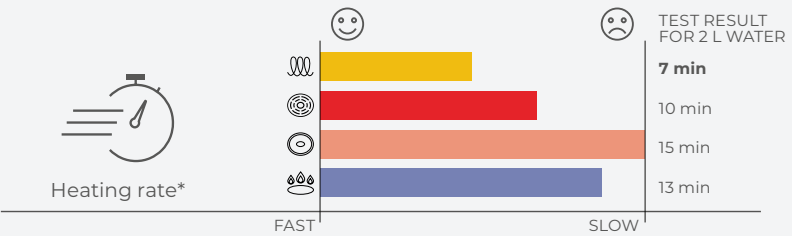
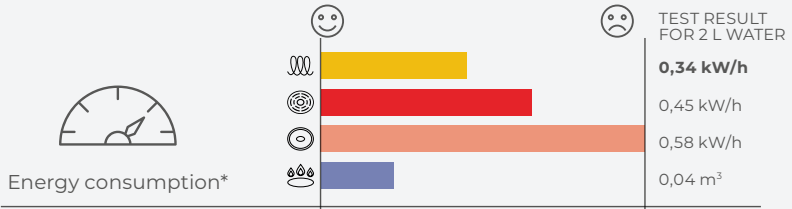

# COOKING LINE 700 FREESTANDING DEVICES



Glass oven door



- control of the food preparation process
- door structure secured against heating

Ergonomic door handle



- convenient and safe use
- easy to keep clean

Higher chimneys in gas appliances



- increasing appliance performance
- guaranteed safety and work ergonomics

Design ensures comfort of use



- guaranteed high hygiene at work
- easy to keep clean

## ERGONOMIC - SAFETY - MODERN DESIGN

Stalgast 700 line offers a full range of cooking equipment for professional kitchen facilities, taking into account the individual needs of the customer / investor

- Innovative design solutions provide users with comfortable and safe service
- The high-precision connection system allows the user to arrange the elements in a line or as a kitchen island
- Modern design is a perfect solution for premises with open and semi-open kitchens
- Components from world renowned leaders: EGO, SCHNIDER-ELECTRIC, HELCRA, SELFA, RICA, FLAMGAS guarantee the appliances' reliability and safety
- Our 700 line equipment was designed with respect for environment



Intuitive  
control system



- laser engraved clear and permanent markings of functions and work parameters
- conveniently tilting panel for improved ergonomics

# GAS RANGE

- all types of cookware can be used
- universal ovens give the possibility of static and dynamic heat treatment for all culinary products using gas or electricity
- equipment is adapted to individual technological requirements
- excellent solution for small, medium and large catering establishments



## 4-BURNER RANGE WITH OVEN

- ergonomic knobs
- **laser-engraved front panel**
- work and power light\*
- **appliance protection system available via the control panel**
- different burner configurations: 3.5 kW; 5 kW; 7kW double-crown
- **burner power reduction to 1/3 (economical flame)**
- removable dishwasher-safe bowl
- cast iron grids
- pilot flame
- flame safety device
- **also available in gas versions G27 and G31**
- glass oven door
- dimensions of electric oven with convection 600x400/ GN1/1: 660x445x285 mm (WxDxH)
- dimensions of gas or electric static oven GN2/1: 660x545x285 mm (WxDxH)
- three levels of rails
- **oven with humidity control feature\***
- oven compartment lighting
- adjustable feet



Code	Description	Ø mm	W mm	D mm	H mm	P kW stove/oven	U stove/oven	Oven type	Price net (€)
9710110	4-burners (3,5+2x5+7)	-	800	700	850	20,5 / 5	G20	static	2278,50
9710130	4-burners (3,5+2x5+7)	-	800	700	850	20,5 / 5	G30	static	2278,50
9710210	4-burners (3,5+5+2x7)	-	800	700	850	22,5 / 5	G20	static	2278,50
9710230	4-burners (3,5+5+2x7)	-	800	700	850	22,5 / 5	G30	static	2278,50
9710310	4-burners (2x5+2x7)	-	800	700	850	24,0 / 5	G20	static	2278,50
9710330	4-burners (2x5+2x7)	-	800	700	850	24,0 / 5	G30	static	2278,50
9715110	4-burners (3,5+2x5+7)	-	800	700	850	20,5 / 7,03	G20 / 400	convection	2614,50
9715130	4-burners (3,5+2x5+7)	-	800	700	850	20,5 / 7,03	G30 / 400	convection	2614,50
9715210	4-burners (3,5+5+2x7)	-	800	700	850	22,5 / 7,03	G20 / 400	convection	2614,50
9715230	4-burners (3,5+5+2x7)	-	800	700	850	22,5 / 7,03	G30 / 400	convection	2614,50
9715310	4-burners (2x5+2x7)	-	800	700	850	24,0 / 7,03	G20 / 400	convection	2614,50
9715330	4-burners (2x5+2x7)	-	800	700	850	24,0 / 7,03	G30 / 400	convection	2614,50
9716110	4-burners (3,5+2x5+7)	-	800	700	850	20,5 / 7	G20 / 400	static	2572,50
9716130	4-burners (3,5+2x5+7)	-	800	700	850	20,5 / 7	G30 / 400	static	2572,50
9716210	4-burners (3,5+2x5+7)	-	800	700	850	22,5 / 7	G20 / 400	static	2572,50
9716230	4-burners (3,5+5+2x7)	-	800	700	850	22,5 / 7	G30 / 400	static	2572,50
9716310	4-burners (2x5+2x7)	-	800	700	850	24,0 / 7	G20 / 400	static	2572,50
9716330	4-burners (2x5+2x7)	-	800	700	850	24,0 / 7	G30 / 400	static	2572,50
990999	Oven grate GN2/1	-	650	530	-	-	-	-	52,20
970000	Reducer cap for grate	-	200	200	-	-	-	-	13,00
970005	WOK overlay	225	-	-	35	-	-	-	47,00

## 6-BURNER RANGE WITH OVEN

- ergonomic knobs
- **laser-engraved front panel**
- work and power light\*
- **appliance protection system available via the control panel**
- neutral cupboard with doors
- different burner configurations: 3,5kW; 5kW; 7kW double-crown; 9kW double-crown
- **burner power reduction to 1/3 (economical flame)**
- removable dishwasher-safe bowl
- cast iron grids
- pilot flame
- flame safety device
- **also available in gas versions G27 and G31**
- glass oven door
- dimensions of electric oven with convection 600x400/ GN1/1: 660x445x285 mm (WxDxH)
- dimensions of gas or electric oven with convection GN2/1: 660x545x285 mm (WxDxH)
- three levels of rails
- **oven with humidity control feature\***
- oven compartment lighting
- adjustable feet

Intuitive control system



Ergonomic oven door handle



Humidity control system\*



Code	Description	Ø mm	W mm	D mm	H mm	P kW stove/oven	U stove/oven	Oven type	Price net (€)
9711110	6-burners (3,5+3x5+2x7)	-	1200	700	850	32,5 / 5	G20	static	3139,50
9711130	6-burners (3,5+3x5+2x7)	-	1200	700	850	32,5 / 5	G30	static	3139,50
9711210	6-burners (3,5+2x5+2x7+9)	-	1200	700	850	36,5 / 5	G20	static	3139,50
9711230	6-burners (3,5+2x5+2x7+9)	-	1200	700	850	36,5 / 5	G30	static	3139,50
9717110	6-burners (3,5+3x5+2x7)	-	1200	700	850	32,5 / 7,03	G20 / 400	convection	3381,00
9717130	6-burners (3,5+3x5+2x7)	-	1200	700	850	32,5 / 7,03	G30 / 400	convection	3381,00
9717210	6-burners (3,5+2x5+2x7+9)	-	1200	700	850	36,5 / 7,03	G20 / 400	convection	3381,00
9717230	6-burners (3,5+2x5+2x7+9)	-	1200	700	850	36,5 / 7,03	G30 / 400	convection	3381,00
9718110	6-burners (3,5+3x5+2x7)	-	1200	700	850	32,5 / 7	G20 / 400	static	3265,50
9718130	6-burners (3,5+3x5+2x7)	-	1200	700	850	32,5 / 7	G30 / 400	static	3265,50
9718210	6-burners (3,5+2x5+2x7+9)	-	1200	700	850	36,5 / 7	G20 / 400	static	3265,50
9718230	6-burners (3,5+2x5+2x7+9)	-	1200	700	850	36,5 / 7	G30 / 400	static	3265,50
990999	Oven grate 2/1	-	650	530	-	-	-	-	52,20
970000	Reducer cap for grate	-	200	200	-	-	-	-	13,00
970005	WOK overlay	225	-	-	35	-	-	-	47,00

## ECO GAS RANGES

- all types of cookware can be used
- universal ovens give the possibility of static and dynamic heat treatment for all culinary products using electricity
- equipment is adapted to individual technological requirements
- excellent solution for small, medium and large catering establishments

INOX



PL POLISH PRODUCT

### 4-BURNER RANGE WITH OVEN, ECO

- ergonomic knobs
- **laser-engraved front panel**
- work and power light\*
- **appliance protection system available via the control panel**
- different burner configurations: 3,5kW, 5kW
- **burner power reduction to 1/3 (economical flame)**
- removable dishwasher-safe bowl
- cast iron grids
- pilot flame
- flame safety device
- **also available in gas versions G27 and G31**
- dimensions of electric oven with convection: 600x400/GN1/1: 660x445x285 (WxDxH)
- three levels of rails
- **oven with humidity control feature**
- adjustable feet



Code	Description	W mm	D mm	H mm	P kW stove/oven	U stove/oven	Oven type	Price net (€)
9713610	4-burners (2x3,5+2x5kW)	800	700	850	17,0 / 6,5	G20 / 400	convection	<b>2362,50</b>
9713630	4-burners (2x3,5+2x5kW)	800	700	850	17,0 / 6,5	G30 / 400	convection	<b>2362,50</b>
9713710	4-burners (4x3,5kW)	800	700	850	14,0 / 6,5	G20 / 400	convection	<b>2362,50</b>
9713730	4-burners (4x3,5kW)	800	700	850	14,0 / 6,5	G30 / 400	convection	<b>2362,50</b>



## 6-BURNER RANGE WITH OVEN, ECO

- ergonomic knobs
- **laser-engraved front panel**
- work and power light\*
- **appliance protection system available via the control panel**
- neutral cupboard with doors
- different burner configurations: 3,5kW; 5kW
- **burner power reduction to 1/3 (economical flame)**
- removable dishwasher-safe bowl
- cast iron grids
- pilot flame
- flame safety device
- **also available in gas versions G27 and G31**
- dimensions of electric oven with convection: 600x400/GN1/1: 660x445x285 (WxDxH)
- three levels of rails
- **oven with humidity control feature**
- adjustable feet

Intuitive  
control  
system



Ergonomic  
oven door  
handle



Humidity  
control  
system\*



Code	Description	W mm	D mm	H mm	P kW stove/oven	U stove/oven	Oven type	Price net (€)
<b>9714310</b>	6-burners (3x3,5+3x5)	1200	700	850	25,5 / 6,5	G20 / 400	convection	<b>2835,00</b>
<b>9714330</b>	6-burners (3x3,5+3x5)	1200	700	850	25,5 / 6,5	G30 / 400	convection	<b>2835,00</b>
<b>9714410</b>	6-burners (6x3,5)	1200	700	850	21,0 / 6,5	G20 / 400	convection	<b>2835,00</b>
<b>9714430</b>	6-burners (6x3,5)	1200	700	850	21,0 / 6,5	G30 / 400	convection	<b>2835,00</b>

## COOKING TOP

- ergonomic knobs
- **laser-engraved front panel**
- different burner configurations: 3,5kW; 5kW; 7kW double-crown
- **burner power reduction to 1/3 (economical flame)**
- removable dishwasher-safe bowl
- cast iron grids
- pilot flame
- flame safety device
- **also available in gas versions G27 and G31**
- can be installed on open skeletal structure or base with a door
- **appliances in the version without a combustion chimney allow working with utensils with a larger diameter**
- a chimney can be used as optional equipment
- adjustable feet

Cast iron grids



Removable large stove bowl



Code	Description	Ø mm	W mm	D mm	H mm	P kW	U	Price net (€)
<b>9705110</b>	2-burners (3,5+5)	-	400	700	250	8,5	G20	<b>798,00</b>
<b>9705130</b>	2-burners (3,5+5)	-	400	700	250	8,5	G30	<b>798,00</b>
<b>9705210</b>	2-burners (3,5+7)	-	400	700	250	10,5	G20	<b>798,00</b>
<b>9705230</b>	2-burners (3,5+7)	-	400	700	250	10,5	G30	<b>798,00</b>
<b>9706110</b>	4-burners (3,5+2x5+7)	-	800	700	250	20,5	G20	<b>1312,50</b>
<b>9706130</b>	4-burners (3,5+2x5+7)	-	800	700	250	20,5	G30	<b>1312,50</b>
<b>9706210</b>	4-burners (3,5+5+2x7)	-	800	700	250	22,5	G20	<b>1312,50</b>
<b>9706230</b>	4-burners (3,5+5+2x7)	-	800	700	250	22,5	G30	<b>1312,50</b>
<b>9706310</b>	4-burners (2x5+2x7)	-	800	700	250	24,0	G20	<b>1312,50</b>
<b>9706330</b>	4-burners (2x5+2x7)	-	800	700	250	24,0	G30	<b>1312,50</b>
<b>9707110</b>	6-burners (3,5+3x5+2x7)	-	1200	700	250	32,5	G20	<b>1711,50</b>
<b>9707130</b>	6-burners (3,5+3x5+2x7)	-	1200	700	250	32,5	G30	<b>1711,50</b>
<b>9707210</b>	6-burners (3,5+2x5+2x7+9)	-	1200	700	250	36,5	G20	<b>1711,50</b>
<b>9707230</b>	6-burners (3,5+2x5+2x7+9)	-	1200	700	250	36,5	G30	<b>1711,50</b>
<b>970000</b>	Reducer cap for grate	-	200	200	-	-	-	<b>13,00</b>
<b>9700020</b>	Chimney grid net for modules 400 mm	-	-	-	-	-	-	<b>86,00</b>
<b>9700040</b>	Chimney grid net for modules 800 mm	-	-	-	-	-	-	<b>99,00</b>
<b>9700060</b>	Chimney grid net for modules 1200 mm	-	-	-	-	-	-	<b>120,00</b>
<b>970005</b>	WOK overlay	225	-	-	35	-	-	<b>47,00</b>

Reducer cap recommended for 3.5 kW and 5 kW burners



## INDUCTION RANGES

- intended for thermal processing in utensils dedicated to induction technology
- induction technology offers reduced energy consumption and better work dynamics compared to gas and traditional electric tops and ranges
- equipment line dedicated as elements of the heating chain or as independent heat treatment stations
- intended for small, medium and large catering establishments



### INDUCTION COOKER

- ergonomic knobs
- **laser-engraved front panel**
- **induction hobs with a diameter of 250 mm and power of 3.5 kW**
- **9 power levels controlled by a knob**
- **cookware efficient cooling system**
- residual heat indicator
- utensil recognition system
- automatic overheating protection system
- work parameters display
- **appliances in the version without a combustion chimney allow working with utensils with a larger diameter**
- a chimney can be used as optional equipment
- adjustable feet



Display



Ceramic induction hobs



Code	Description	W mm	D mm	H mm	P kW	U V	Price net (€)
<b>9705100</b>	2 hobs	400	700	850	7	400	<b>3118,50</b>
<b>9706100</b>	4 hobs	800	700	850	14	400	<b>5491,50</b>
<b>9700020</b>	Chimney grid net for modules 400 mm	-	-	-	-	-	<b>86,00</b>
<b>9700040</b>	Chimney grid net for modules 800 mm	-	-	-	-	-	<b>99,00</b>

## CERAMIC TOPS

- intended for thermal processing in all types of cookware using electricity
- technology used in infrared stoves gives energy savings and work dynamics, unavailable for appliances with cast iron electric hobs
- equipment line dedicated as elements of the cooking line or as independent heat treatment stations
- intended for small, medium and large catering establishments



### CERAMIC COOKING TOP

- ergonomic knobs
- **laser-engraved front panel**
- work controls
- **HiLight hobs**
- hobs with a diameter of 225 mm and power of 2.5 kW
- **2 heating zones with TURBO feature**
- automatic overheating protection system
- smooth power adjustment
- **appliances in the version without a combustion chimney allow working with utensils with a larger diameter**
- a chimney can be used as optional equipment
- adjustable feet



Intuitive control panel



Ceramic hobs



Code	Description	W mm	D mm	H mm	P kW	U V	Price net (€)
9705500	2 hobs	400	700	250	5	400	787,50
9706500	4 hobs	800	700	250	10	400	1375,50
9700020	Chimney grid net for modules 400 mm	-	-	-	-	-	86,00
9700040	Chimney grid net for modules 800 mm	-	-	-	-	-	99,00

## ELECTRIC RANGES

- all types of cookware can be used
- universal application ovens used in kitchens give the possibility of static and dynamic heat treatment for all culinary products using electricity
- equipment better meets customer's need and requirements
- intended for small, medium and large catering establishments

INOX



PL POLISH PRODUCT

### 4-HOB ELECTRIC RANGE WITH OVEN

- ergonomic knobs
- **laser-engraved front panel**
- work and power light
- **appliance protection system available via the control panel**
- cast iron hobs with a diameter of 220 mm and power of 2.6 kW
- six-level power adjustment range
- pressed top plate
- glass oven door
- dimensions of electric oven with convection 600x400/ GN1/1: 660x445x285 mm (WxDxH)
- size of electric static oven GN 2/1: 660x545x285 mm (WxDxH)
- three levels of rails
- **electric oven with humidity control feature**
- oven compartment lighting
- oven grate included
- adjustable feet



Humidity control system



Pressed stove bowl



Code	Description	W mm	D mm	H mm	P kW stove/oven	U V	Oven type	Price net (€)
<b>9715000</b>	4 hobs	800	700	850	10,4 / 7	400	convection	<b>2299,50</b>
<b>9716000</b>	4 hobs	800	700	850	10,4 / 7	400	static	<b>2352,00</b>
<b>990999</b>	Oven grate GN 2/1	650	530	-	-	-		<b>52,20</b>

6-HOB ELECTRIC RANGE WITH OVEN

- ergonomic knobs
- **laser-engraved front panel**
- work and power light
- **appliance protection system available via the control panel**
- neutral cupboard with doors
- cast iron hobs with a diameter of 220 mm and power of 2.6 kW
- six-level power adjustment range
- pressed top plate
- glass oven door
- dimensions of electric oven with convection 600x400/ GN1/1: 660x445x285 mm (WxDxH)
- size of static oven GN 2/1: 660x545x285 mm (WxDxH)
- three levels of rails
- **electric oven with humidity control feature**
- oven compartment lighting
- oven grate included
- adjustable feet

Intuitive control system



Humidity control system



Auxiliary cupboard



Code	Description	W mm	D mm	H mm	P kW stove/oven	U V	Oven type	Price net (€)
<b>9717000</b>	6 hobs	1200	700	850	15,6 / 7	400	convection	<b>2730,00</b>
<b>9718000</b>	6 hobs	1200	700	850	15,6 / 7	400	static	<b>2782,50</b>
<b>990999</b>	Oven grate GN 2/1	650	530	-	-	-	-	<b>52,20</b>



## ELECTRIC HOB TOP

- ergonomic knobs
- **laser-engraved front panel**
- work and power light
- cast iron hobs with a diameter of 220 mm and power of 2.6 kW
- six-level power adjustment range
- pressed top plate
- can be installed on open skeletal structure or base with a door
- **appliances in the version without a combustion chimney allow working with utensils with a larger diameter**
- **a chimney can be used as optional equipment**
- adjustable feet

Ergonomic control panel



Rounded edges



Code	Description	W mm	D mm	H mm	P kW	U V	Price net (€)
<b>9705000</b>	2 hobs	400	700	250	5,2	400	<b>598,50</b>
<b>9706000</b>	4 hobs	800	700	250	10,4	400	<b>892,50</b>
<b>9707000</b>	6 hobs	1200	700	250	15,6	400	<b>1176,00</b>
<b>9700020</b>	Chimney grid net for modules 400 mm	-	-	-	-	-	<b>86,00</b>
<b>9700040</b>	Chimney grid net for modules 800 mm	-	-	-	-	-	<b>99,00</b>
<b>9700060</b>	Chimney grid net for modules 1200 mm	-	-	-	-	-	<b>120,00</b>

# FRY TOPS AND GRILLS

INOX PL POLISH PRODUCT

- processes carried out using liquid or natural gas, or electricity
- equipment line dedicated as elements of the heating chain or as independent heat treatment stations
- equipment offer adapted to individual technological requirements
- intended for small, medium and large catering establishments.

## GAS FRY TOP



- ergonomic knobs
- **laser-engraved front panel**
- **appliance protection system available via the control panel**
- **working surface 2200/4400 cm<sup>2</sup>**
- working temperature range up to 300°C
- two separate work areas
- waste and grease discharge hole
- grease container
- spark generator powered by 230V
- elevated rear edges
- **also available in gas versions G27 and G31**
- adjustable feet



Code	Description	W mm	D mm	H mm	P kW	U	Price net (€)
<b>9730110</b>	Single smooth	400	700	250	6,5	G20	<b>1312,50</b>
<b>9730130</b>	Single smooth	400	700	250	6,5	G30	<b>1312,50</b>
<b>9730210</b>	Single ribbed	400	700	250	6,5	G20	<b>1323,00</b>
<b>9730230</b>	Single ribbed	400	700	250	6,5	G30	<b>1323,00</b>
<b>9731110</b>	Double ribbed	800	700	250	13	G20	<b>2310,00</b>
<b>9731130</b>	Double ribbed	800	700	250	13	G30	<b>2310,00</b>
<b>9731210</b>	Double ribbed	800	700	250	13	G20	<b>2310,00</b>
<b>9731230</b>	Double ribbed	800	700	250	13	G30	<b>2310,00</b>
<b>9731310</b>	Double smooth/ribbed	800	700	250	13	G20	<b>2310,00</b>
<b>9731330</b>	Double smooth/ribbed	800	700	250	13	G30	<b>2310,00</b>

Waste and grease drawer

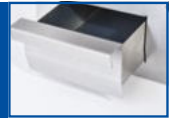

Easy to clean surface



## ELECTRIC FRY TOP



- ergonomic knobs
- **laser-engraved front panel**
- work and power light
- **appliance protection system available via the control panel**
- **working surface 2200/4400 cm<sup>2</sup>**
- working temperature range up to 300°C
- two independent heating zones
- waste and grease discharge hole
- grease container
- elevated rear edges
- can be installed on open skeletal structure or base with a door
- adjustable feet



Code	Description	W mm	D mm	H mm	P kW	U V	Price net (€)
<b>9730100</b>	Single smooth	400	700	250	4,05	400	<b>1048,95</b>
<b>9730200</b>	Single ribbed	400	700	250	4,05	400	<b>1218,00</b>
<b>9731100</b>	Double ribbed	800	700	250	8,1	400	<b>1659,00</b>
<b>9731200</b>	Double ribbed	800	700	250	8,1	400	<b>1774,50</b>
<b>9731300</b>	Double smooth/ribbed	800	700	250	8,1	400	<b>1774,50</b>
<b>9700020</b>	Chimney grid net for modules 400 mm	-	-	-	-	-	<b>86,00</b>
<b>9700040</b>	Chimney grid net for modules 800 mm	-	-	-	-	-	<b>99,00</b>

Smooth/ribbed hob



Ergonomic control panel



**ELECTRIC FRY TOP WITH LID**



- enhances the cooking effect of grilled products
- **energy consumption reduced by approx. 30%**
- lid structure made of stainless steel
- **has a glass, thermometer and baffles**
- the height of the grill with the lid open, approx. 920 mm
- ergonomic knobs
- **laser-engraved front panel**
- work and power light
- **appliance protection system available via the control panel**
- **working surface 2200/4400 cm<sup>2</sup>**
- working temperature range up to 300°C
- two separate work areas
- waste and grease discharge hole
- grease container
- high edges increase the comfort of work
- can be installed on open skeletal structure or base with a door
- adjustable feet



Thermometer



Humidity control system

Code	Description	W mm	D mm	H mm	U V	P kW	Price net (€)
9731190	Smooth	800	700	430	400	8,1	1879,50
9731290	Ribbed	800	700	430	400	8,1	1995,00
9731390	Smooth/ribbed	800	700	430	400	8,1	1995,00

**WATER GRILL**

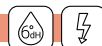

- ergonomic knobs
- **laser-engraved front panel**
- work and power light
- smooth temperature control
- **special grid integrated with the heater that quickly reaches the operating temperature**
- **steam grilling system makes the food more juicy and crispy**
- grease and condensate flow down into a special water-filled tank
- the tank is easy to keep clean
- has a self-cleaning feature
- special cleaning scraper included
- **chimney use optional**
- adjustable feet



Ergonomic control panel

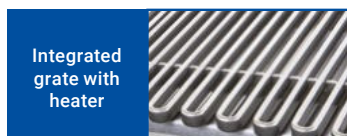

Integrated grate with heater

Code	Description	W mm	D mm	H mm	P kW	U V	Price net (€)
9732000	Grill wodny	400	700	250	4,08	400	1669,50
9733000	Grill wodny	800	700	250	8,16	400	2730,00
9700020	Chimney grid net for modules 400 mm	-	-	-	-	-	86,00
9700040	Chimney grid net for modules 800 mm	-	-	-	-	-	99,00

# CHROME FRY TOPS AND GRILLS

INOX

PL POLISH PRODUCT

- designed for contact frying and grilling of various types of products; natural gas, propan-butan or electric-powered
- line of equipment that can be used as an element of the cooking line or as an independent heat treatment stations
- devices adapted to individual technological requirements
- designed for small, medium and large gastronomy

## GAS FRY TOP, CHROME GRIDDLE



- chrome griddle
- ergonomic knobs
- **laser-engraved front panel**
- **appliance protection system available via the control panel**
- **working surface: 2200/4400 cm<sup>2</sup>**
- working temperature range up to 300°C
- two separate working zones for 800 mm plates
- waste and grease drainage hole leading to the grease collector
- spark generator powered by 230V
- elevated rear edges
- can be mounted on a frame base or on a cabinet base with doors
- **also available in gas versions G27 and G31**
- adjustable feet



Code	Description	W mm	D mm	H mm	P kW	U	Price net (€)
<b>9736110</b>	Single smooth	400	700	250	6,5	G20	<b>1501,50</b>
<b>9736130</b>	Single smooth	400	700	250	6,5	G30	<b>1501,50</b>
<b>9736210</b>	Single ribbed	400	700	250	6,5	G20	<b>1564,50</b>
<b>9736230</b>	Single ribbed	400	700	250	6,5	G30	<b>1564,50</b>
<b>9737110</b>	Double ribbed	800	700	250	13	G20	<b>2845,50</b>
<b>9737130</b>	Double ribbed	800	700	250	13	G30	<b>2845,50</b>
<b>9737210</b>	Double ribbed	800	700	250	13	G20	<b>2845,50</b>
<b>9737230</b>	Double ribbed	800	700	250	13	G30	<b>2845,50</b>
<b>9737310</b>	Double smooth/ribbed	800	700	250	13	G20	<b>2845,50</b>
<b>9737330</b>	Double smooth/ribbed	800	700	250	13	G30	<b>2845,50</b>

Waste and grease drawer

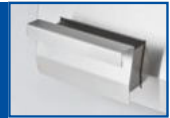

Easy to clean surface



## ELECTRIC FRY TOP, CHROME GRIDDLE



- chrome griddle
- ergonomic knobs
- **laser-engraved front panel z kontrolkami pracy i zasilania**
- **appliance protection system available via the control panel**
- **working surface: 2200/4400 cm<sup>2</sup>**
- working temperature range up to 300°C
- two separate working zones for 800 mm plates
- waste and grease drainage hole leading to the grease collector
- elevated rear edges
- can be mounted on a frame base or on a cabinet base with doors
- adjustable feet



Smooth/ribbed hob



Ergonomic control panel



Code	Description	W mm	D mm	H mm	P kW	U V	Price net (€)
<b>9736100</b>	Single smooth	400	700	250	4,05	400	<b>1218,00</b>
<b>9736200</b>	Single ribbed	400	700	250	4,05	400	<b>1365,00</b>
<b>9737100</b>	Double ribbed	800	700	250	8,1	400	<b>1942,50</b>
<b>9737200</b>	Double ribbed	800	700	250	8,1	400	<b>2068,50</b>
<b>9737300</b>	Double smooth/ribbed	800	700	250	8,1	400	<b>2068,50</b>



LAVA GRILL

- laser-engraved front panel
- burner with flame safety device
- spark generator powered by 230V
- burner pilot flame
- smooth temperature control in the range 120-300 °C
- appliances with an S or V grate
- also available in gas versions G27 and G31
- adjustable feet



Type V  
grid ideal  
for grilling  
meat and  
vegetables



Lava stones  
included



Type S grid  
ideal for  
grilling fish  
and seafood



Ash drawer



Code	Product	W mm	D mm	H mm	P kW	U V	Price net (€)
9732010	Lava grill (grate V)	400	700	850	8	G20	1732,50
9732030	Lava grill (grate V)	400	700	850	8	G30	1732,50
9732110	Lava grill (grate S)	400	700	850	8	G20	1795,50
9732130	Lava grill (grate S)	400	700	850	8	G30	1795,50
9733010	Lava grill (grate V)	800	700	850	16	G20	2068,50
9733030	Lava grill (grate V)	800	700	850	16	G30	2068,50
9733110	Lava grill (grate S)	800	700	850	16	G20	2068,50
9733130	Lava grill (grate S)	800	700	850	16	G30	2068,50
973997	Type S fish grate for 400 units	-	-	-	-	-	180,00
973998	Type S fish grate for 400 units	-	-	-	-	-	360,00
973999	Lava stones	-	-	-	-	-	12,50

# FRYERS

INOX PL POLISH PRODUCT

- intended for direct thermal processing of food, consisting in frying; processes carried out using liquid or natural gas, or electricity
- equipment line or as a freestanding unit dedicated as elements of the heating chain or as independent heat treatment stations
- equipment offer adapted to individual technological requirements
- intended for small, medium and large catering establishments

## GAS FRYER



- **compartment capacity up to 17 liters**
- burner with flame safety device
- burner pilot flame
- temperature control in the range 90-190°C
- „cold zone” system
- spark generator powered by 230V
- **frying oil release into the container**
- fryers 9725110 and 9725130 fitted with a basket 310x300x120 mm
- fryers 9725210 and 9725230 fitted with a basket 130x300x120 mm
- **rying oil container with filter included**
- **also available in gas versions G27 and G31**
- adjustable feet

Frying oil container with filter

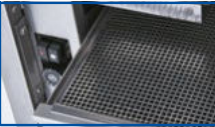

Efficient gas burner system



Code	Product	W mm	D mm	H mm	V liters	P kW	U V	Price net (€)
<b>9725110</b>	Single fryer	400	700	850	17	15	G20	<b>2215,50</b>
<b>9725130</b>	Single fryer	400	700	850	17	15	G30	<b>2215,50</b>
<b>9725210</b>	Double fryer	400	700	850	2x7	12	G20	<b>3139,50</b>
<b>9725230</b>	Double fryer	400	700	850	2x7	12	G30	<b>3139,50</b>



## FRYERS

- intended for direct thermal processing of food, consisting in frying; processes carried out using liquid or natural gas, or electricity
- equipment line or as a freestanding unit dedicated as elements of the heating chain or as independent heat treatment stations
- equipment offer adapted to individual technological requirements
- intended for small, medium and large catering establishments

INOX

PL POLISH  
PRODUCT

### ELECTRIC FRYER



- ergonomic knobs
- **laser-engraved front panel**
- work and power light
- **appliance protection system available via the control panel**
- temperature range up to 190°C
- „cold zone” system
- power cut protection after removing the heater
- movable heating elements for easy cleaning
- safe frying oil release
- can be installed on open skeletal structure or base with a door
- fitted with a basket 210x350x110 mm
- **optional placement of two baskets in one compartment (2x 105x350x110 mm)**
- adjustable feet

#### Cold zone

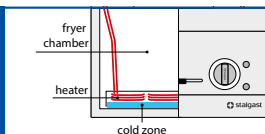

#### Possibility of placing two baskets in the compartment



Code	Product	W mm	D mm	H mm	V liters	P kW	U V	Price net(€)
<b>9725000</b>	Single fryer	400	700	250	10	9	400	<b>1491,00</b>
<b>9725500</b>	Single fryer	400	700	850	15	15	400	<b>1732,50</b>
<b>9726000</b>	Double fryer	800	700	250	2x10	18	400	<b>2352,00</b>
<b>979991</b>	Set of two baskets for 9725000, 9726000	105	350	110	-	-	-	<b>225,00</b>

# FRIES WARMER

INOX

PL POLISH PRODUCT

- designed to maintain the temperature of dishes using electricity
- Line of equipment that can be used as an element of the heating line or as an independent heat treatment stations, devices are adapted to individual technological requirements
- intended for small, medium and large gastronomy

## FRIES WARMER



- laser-engraved front panel
- operation and power controls
- designed to keep food warm
- capacity: GN1 / 1
- can be mounted on an empty base unit or hinging door unit
- adjustable feet



Efficient heating lamp



Drip strainer



Ergonomic control panel



Handles for easy removal of the container



Code	W mm	D mm	H mm	T °C	P kW	U V	Price net (€)
9724500	400	700	440	up to 75	1	230	1155,00

## PANS

INOX

PL POLISH PRODUCT

- intended for direct thermal processing of food, consisting in stewing, cooking, frying or grilling; processes carried out using liquid or natural gas, or electricity
- equipment line dedicated as elements of the heating chain or as independent heat treatment stations
- equipment offer adapted to individual technological requirements
- intended for small, medium and large catering establishments

### GAS BRATT PAN



- ergonomic knobs
- **laser-engraved front panel**
- **appliance protection system available via the control panel**
- spark generator powered by 230V
- **allows manual dosage of water**
- **precise manual mechanism of tilting the working bowl**
- **narrow bowl outflow**
- **smoothly adjustable lid opening**
- **bowl working surface 0.35m<sup>2</sup>**
- **volume 58 l\***
- **intended for stewing, cooking and frying**
- temperature control in the range 100-300°C
- **also available in gas versions G27 and G31**
- adjustable feet



Automatic temperature control



Precise bowl tilting system



Code	W mm	D mm	H mm	P kW	S chops/h	U	V liters	Price net (€)
9740010	800	700	850	17	~200	G20	58	3465,00
9740030	800	700	850	17	~200	G30	58	3465,00

**ELECTRIC BRATT PAN**



- ergonomic knobs
- **laser-engraved front panel**
- work and power light
- **allows manual dosage of water**
- **appliance protection system available via the control panel**
- **precise manual mechanism of tilting the working bowl**
- **narrow bowl outflow**
- **smoothly adjustable lid opening**
- **bowl working surface 0.35m<sup>2</sup>**
- **volume 58 l\***
- **intended for stewing, cooking and frying**
- temperature control in the range 60-300°C
- adjustable feet



Water pouter



Outflow adapted to small utensils



Ergonomic control panel

Code	W mm	D mm	H mm	P kW	S chops/h	U V	V liters	Price net (€)
<b>9740000</b>	800	700	850	10,8	~200	400	58	<b>3433,50</b>

**MULTIFUNCTION PAN**



- **intended for stewing, frying, cooking and grilling**
- ergonomic knobs
- **laser-engraved front panel**
- work and power light
- **appliance protection system available via the control panel**
- **bowl contents release**
- **bowl stopper with safety overflow**
- **working surface 0.16m<sup>2</sup>**
- **volume 13 liters\***
- **chimney use optional**
- adjustable feet



Chute for GN containers

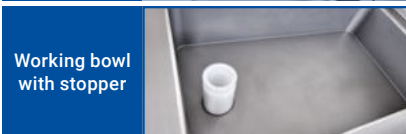

Working bowl with stopper

Code	Product	W mm	D mm	H mm	V liters	S kg/h	P kW	U V	Price net (€)
<b>9741000</b>	Pan	400	700	850	13	90	5	400	<b>1564,50</b>
<b>9700020</b>	Chimney grid net for modules 400 mm	-	-	-	-	-	-	-	<b>86,00</b>

## INDUCTION WOK

- intended for thermal processing in utensils dedicated to induction technology
- technology used in induction stoves gives outstanding energy savings and work dynamics, unavailable for appliances with traditional gas or electric supply
- appliance dedicated as an element of the heating chain or as independent heat treatment station
- intended for small, medium and large catering establishments



### WOK

- ergonomic knob
- laser-engraved front panel
- induction bowl diameter 290 mm, 5 kW
- 9 power levels controlled by a knob
- efficient cooling system
- residual heat indicator
- utensil recognition system
- automatic overheating protection system
- work parameters display
- **appliance in the version without a combustion chimney**
- **chimney use optional**
- adjustable feet



Display



Induction bowl

Code	Product	W mm	D mm	H mm	V liters	P kW	U	Price net (€)
<b>9704005</b>	Wok	400	700	850	25	5	400	<b>2320,50</b>
<b>9700020</b>	Chimney grid net for modules 400 mm	400	-	-	-	-	-	<b>86,00</b>

### WOK PAN

- 037400 satin steel, handle length 200 mm
- 037401 polished steel, handle length 185 mm

Code	Ø mm	H mm	Price net (€)
<b>037400</b>	400	120	<b>21,80</b>
<b>037401</b>	400	120	<b>32,20</b>





## BAIN-MARIES

- intended to maintain the food temperature; process carried out using electricity
- equipment line dedicated as elements of the heating chain or as independent heat treatment
- equipment offer adapted to individual technological requirements
- intended for small, medium and large catering establishments



### BAIN-MARIE

- ergonomic knobs
- **laser-engraved front panel**
- work and power light
- **appliance protection system available via the control panel**
- temperature control in the range 30 to 95°C
- safe water drain
- volume: GN 1/1 or 2xGN 1/1 (max. height 150 mm)
- support rail included in model 9721000
- compartment size:  
model 9720000 306x508x155 mm  
model 9721000 630x508x155 mm
- can be installed on open skeletal structure or base with a door
- **chimney use optional**
- adjustable feet

Functional control panel



3 examples of GN setups

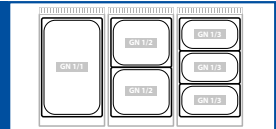

Code	Product	W mm	D mm	H mm	P kW	U V	Price net (€)
9720000	Bain-marie	400	700	250	0,8	230	<b>787,50</b>
9721000	Bain-marie	800	700	250	1,6	230	<b>1186,50</b>
9700020	Chimney grid net for modules 400 mm						<b>86,00</b>
9700040	Chimney grid net for modules 800 mm						<b>99,00</b>



## PASTA COOKER

- intended for direct thermal processing of food, consisting in cooking
- process carried out using liquid or natural gas, or electricity
- equipment line dedicated as elements of the heating chain or as independent heat treatment stations
- equipment offer adapted to individual technological requirements
- intended for small, medium and large catering establishments

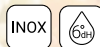

### GAS PASTA COOKER

- ergonomic knobs
- **laser-engraved front panel**
- **appliance protection system against running without water, available via the control panel**
- spark generator powered by 230V
- **allows manual dosage of water**
- solenoid valve for filling with water
- overflow hole
- water drain outlet
- **possibility of using GN 1/3 baskets and/or the GN set 2x1/6**
- **also available in gas versions G27 and G31**
- the price does not include pasta baskets
- adjustable feet



Water pouter



Drip tray



Code	Product	W mm	D mm	H mm	V liters	P kW	U	Price net (€)
<b>9745110</b>	Pasta cooker	400	700	850	25	9,1	G20	<b>2089,50</b>
<b>9745130</b>	Pasta cooker	400	700	850	25	9,1	G30	<b>2089,50</b>
<b>979992</b>	Pasta basket (standard GN 1/3)	-	-	-	-	-	-	<b>110,00</b>
<b>979993</b>	Pasta basket (standard GN 1/6)	-	-	-	-	-	-	<b>150,00</b>

**ELECTRIC PASTA COOKER**



- ergonomic knobs
- **laser-engraved front panel**
- work and power light
- **appliance protection system against running without water, available via the control panel**
- stainless steel heating elements placed inside the container
- solenoid valve for filling with water
- overflow hole
- water drain outlet
- **possibility of using GN 1/3 baskets and/or the GN set 2x1/6**
- **chimney use optional**
- the price does not include pasta baskets
- adjustable feet



Ergonomic control panel



Pasta baskets



Code	Product	W mm	D mm	H mm	S kg/h	P kW	U V	Price net (€)
<b>9745000</b>	Pasta cooker	400	700	850	15	6	400	<b>1648,50</b>
<b>979992</b>	Pasta basket (standard GN 1/3)	-	-	-	-	-	-	<b>110,00</b>
<b>979993</b>	Pasta basket (standard GN 1/6)	-	-	-	-	-	-	<b>150,00</b>
<b>9700020</b>	Chimney grid net for modules 400 mm	-	-	-	-	-	-	<b>86,00</b>

## NEUTRAL ELEMENTS



- intended for storage and expanding the working surface on worktops
- neutral elements dedicated as a supplement of the heating chain or as independent work station
- intended for small, medium and large catering establishments

### NEUTRAL STATION

- fully-extendable drawer (9700210, 9700410, 9700610)
- chimney use optional
- can be installed on open skeletal structure or base with a door

Pull-out  
drawer in GN  
standard



Chimney use  
optional

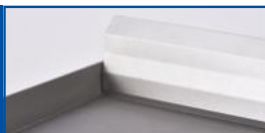

No.	Code	Product	W mm	D mm	H mm	Price net (€)
1.	<b>9700200</b>	Neutral station	400	700	250	<b>315,00</b>
	<b>9700400</b>	Neutral station	800	700	250	<b>378,00</b>
	<b>9700600</b>	Neutral station	1200	700	250	<b>388,50</b>
2.	<b>9700210</b>	Neutral station with drawer	400	700	250	<b>420,00</b>
	<b>9700410</b>	Neutral station with drawer	800	700	250	<b>535,50</b>
	<b>9700610</b>	Neutral station with 2 drawers	1200	700	250	<b>756,00</b>
	<b>9700020</b>	Chimney grid net for modules 400 mm	-	-	-	<b>86,00</b>
	<b>9700040</b>	Chimney grid net for modules 800 mm	-	-	-	<b>99,00</b>
	<b>9700060</b>	Chimney grid net for modules 1200 mm	-	-	-	<b>120,00</b>

## BASES AND ACCESSORIES

PL POLISH PRODUCT INOX

- intended for storage and increasing the functionality of adjustable appliances
- base line dedicated as elements of the heating chain
- intended for small, medium and large catering establishments

### BASES FOR DEVICES

- reinforced base elements
- possibility to set up three 400 appliances on a 1200 base
- adjustable feet (45mm)



No.	Code	Product	W mm	D mm	H mm	Price net (€)
1.	<b>9701200</b>	Skeletal base	400	575	600	<b>210,00</b>
	<b>9701400</b>	Skeletal base	800	575	600	<b>305,00</b>
	<b>9701600</b>	Skeletal base	1200	575	600	<b>399,00</b>
2.	<b>9702200</b>	Open base	400	575	600	<b>330,75</b>
	<b>9702400</b>	Open base	800	575	600	<b>408,45</b>
	<b>9702600</b>	Open base	1200	575	600	<b>496,65</b>
3.	<b>9703200</b>	Base with doors	400	640	600	<b>418,95</b>
	<b>9703400</b>	Base with doors	800	640	600	<b>573,30</b>
	<b>9703600</b>	Base with doors	1200	640	600	<b>683,55</b>

### DOORS FOR BASES

- doors for self-assembly
- equipped with hinges and mounting plates
- (1) suitable for: 9702200, 9702400
- (2) suitable for: 9702600



### CHIMNEY GRID NET

- a chimney can be used as optional equipment
- dedicated to appliances with a rear edge
- suitable for electric and gas stoves, neutral stations, multifunctional pans, etc.



Code	W mm	Price net (€)
<b>9700020</b>	400 mm	<b>86,00</b>
<b>9700040</b>	800 mm	<b>99,00</b>
<b>9700060</b>	1200 mm	<b>120,00</b>

No.	Code	Product	W mm	D mm	H mm	Price net (€)
1.	<b>9700041</b>	Door 400 - left	393	110	441	<b>100,00</b>
	<b>9700042</b>	Door 400 - right	393	110	441	<b>100,00</b>
2.	<b>9700061</b>	Door 600 - left	593	110	441	<b>120,00</b>
	<b>9700062</b>	Door 600 - right	593	110	441	<b>120,00</b>

### COUNTERTOP CONNECTION STRIP



No.	Code	Product	W mm	D mm	H mm	Price net (€)
1.	<b>9700071</b>	Low short	8	589	19	<b>30,00</b>
	<b>9700072</b>	Low medium	8	619	19	<b>35,00</b>
2.	<b>9700073</b>	Low long	8	660	19	<b>37,00</b>
	<b>9700081</b>	High short	7	589	40	<b>34,00</b>
	<b>9700082</b>	High medium	7	617	40	<b>39,00</b>

### REDUCER CAP

- allows work with small utensils, recommended for 3.5kW and 5kW burners



Code	Ø mm	H mm	Price net (€)
<b>970000</b>	225	35	<b>13,00</b>

### WOK OVERLAY

- allows using WOK cookware directly on a gas stove grate
- made of stainless steel



Code	W mm	D mm	Price net (€)
<b>970005</b>	200	200	<b>47,00</b>

## FREESTANDING DEVICES

- intended for thermal processing in all types of cookware utensils up to 100 liters using gas or electricity, including induction technology
- units may be used as auxiliary elements of the cooking line or as independent heat treatment stations
- designed for small and medium catering establishments and mass catering points
- thanks to modern production technology and the components used, the equipment guarantees high efficiency and a long service life





## GAS STOCKPOT STOVE



- intended for thermal processing in all types of pots up to 100 liters using natural or liquid gas
- appliances may be used as an auxiliary element of the heating chain or as independent heat treatment station
- intended for small and medium catering establishments and mass catering points

### TOP LINE STOCKPOT STOVES

- cast iron grids
- **9kW double-crown burner**
- pilot flame
- burner with flame safety device
- **burner power reduction to 1/3 (economical flame)**
- **suitable for large pots of 50 to 100 l**
- **also available in gas versions G27 and G31**
- adjustable feet



Code	Product	W mm	D mm	H mm	P kW	U	Price net (€)
<b>773001</b>	Single stove	565	605	380	9	G20	<b>504,00</b>
<b>773003</b>	Single stove	565	605	380	9	G30	<b>504,00</b>
<b>773011</b>	Double stove	1140	605	380	2x9	G20	<b>892,50</b>
<b>773013</b>	Double stove	1140	605	380	2x9	G30	<b>892,50</b>
<b>773000</b>	Reducer cap for grate	300	300	10	-	-	<b>20,00</b>



## STANDARD LINE POWER STOCKPOT STOVE

- removable stainless steel grate
- **14 kW burner**
- burner pilot flame
- burner with flame safety device
- **burner power reduction to 1/3 (economical flame)**
- **dedicated for large pots of 50 to 100 l**
- adjustable feet
- using pots with Ø 450-500 mm recommended



14 kW burner

Code	W mm	D mm	H mm	P kW	U	Price net (€)
<b>773035</b>	567	639	394	14	G20	<b>588,00</b>
<b>773036</b>	567	639	394	11	G30	<b>588,00</b>

## STANDARD LINE AUXILIARY STOCKPOT STOVE

- stainless steel grill
- burner pilot flame
- flame safety device
- **burner power reduction to 1/3 (economical flame)**
- suitable for pots up to 40 l
- **also available in gas versions G27 and G31**
- adjustable feet



Code	W mm	D mm	H mm	P kW	U	Price net (€)
<b>773051</b>	340	340	340	5	G30	<b>346,50</b>
<b>773052</b>	340	340	340	5	G20	<b>346,50</b>

## INDUCTION STOCKPOT STOVES

- intended for thermal processing in pots up to 100 liters dedicated to induction technology
- appliances may be used as an auxiliary element of the heating chain or as independent heat treatment station
- intended for small and medium catering establishments and mass catering points

INOX



PL POLISH PRODUCT

### INDUCTION STOCKPOT STOVE

- ergonomic knobs
- **773025 induction hob with a diameter of 340 mm and power of 5 kW**
- **773028 induction hob with a diameter of 400 mm and power of 8 kW**
- **9 power levels controlled by a knob**
- **efficient cooling system**
- pot detection system
- **very robust ceramic plate**
- work parameters display
- **dedicated for large pots of 50 to 100 l**
- adjustable feet



Code	W mm	D mm	H mm	P kW	U V	Price net (€)
<b>773025</b>	500	500	380	5	400	<b>1785,00</b>
<b>773028</b>	600	600	380	8	400	<b>2089,50</b>

## ELECTRIC STOCKPOT STOVES

- intended for thermal processing in all types of pots up to 100 liters using electricity
- appliance may be used as an auxiliary element of the heating chain or as independent heat treatment station
- intended for small and medium catering establishments and mass catering points

INOX



PL POLISH PRODUCT

### ELECTRIC STOCKPOT STOVE

- hob with a diameter of 400 mm and power of 5 kW
- six-level power adjustment range
- **dedicated for large pots of 50 to 100 l**
- adjustable feet



Code	W mm	D mm	H mm	P kW	U V	Price net (€)
<b>773020</b>	580	580	380	5	400	<b>934,50</b>

## FREESTANDING GAS TOPS

- all types of cookware can be used
- equipment line dedicated as auxiliary elements of the heating chain or as independent heat treatment station
- intended for small and medium catering establishments and mass catering points



### FREESTANDING GAS TOP

- cast iron grids
- available in 4 and 6-burner versions
- different burner configurations: 3,5kW; 5kW; 7kW (double-crown); 9kW (double-crown)
- pilot flame
- flame safety device
- **burner power reduction to 1/3 (economical flame)**
- removable dishwasher-safe bowl
- **also available in gas versions G27 and G31**
- adjustable feet



No.	Code	Description	Ø mm	W mm	D mm	H mm	P kW	U	Price net (€)
1.	<b>979511</b>	4-burners (3,5+2x5+7)	-	800	700	850	20,5	G20	<b>1512,00</b>
	<b>979513</b>	4-burners (3,5+2x5+7)	-	800	700	850	20,5	G30	<b>1512,00</b>
	<b>979521</b>	4-burners (3,5+5+2x7)	-	800	700	850	22,5	G20	<b>1512,00</b>
	<b>979523</b>	4-burners (3,5+5+2x7)	-	800	700	850	22,5	G30	<b>1512,00</b>
	<b>979531</b>	4-burners (2x5+2x7)	-	800	700	850	24,0	G20	<b>1512,00</b>
	<b>979533</b>	4-burners (2x5+2x7)	-	800	700	850	24,0	G30	<b>1512,00</b>
	<b>979611</b>	6-burners (3,5+3x5+2x7)	-	1200	700	850	32,5	G20	<b>2142,00</b>
	<b>979613</b>	6-burners (3,5+3x5+2x7)	-	1200	700	850	32,5	G30	<b>2142,00</b>
	<b>979621</b>	6-burners (3,5+2x5+2x7+9)	-	1200	700	850	36,5	G20	<b>2142,00</b>
	<b>979623</b>	6-burners (3,5+2x5+2x7+9)	-	1200	700	850	36,5	G30	<b>2142,00</b>
2.	<b>970000</b>	Reducer overlay	-	200	200	-	-	-	<b>13,00</b>
	<b>970005</b>	WOK overlay	225	-	-	35	-	-	<b>47,00</b>

### REDUCER CAP

- allows work with small utensils, recommended for 3.5kW and 5kW burners



**FREESTANDING GAS TOP**

- available in 4 and 6-burner versions
- different burner configurations: 3,5kW; 5kW; 7kW double-crown; 9kW double-crown
- pilot flame
- flame safety device
- **burner power reduction to 1/3 (economical flame)**
- removable dishwasher-safe bowl
- **also available in gas versions G27 and G31**
- adjustable feet



Cast iron grids



No.	Nr kat	Description	Ø mm	W mm	D mm	H mm	P kW	U	Price net (€)
1.	<b>999511</b>	4-burners (3,5+2x5+7)	-	900	900	850	20,5	G20	<b>1617,00</b>
	<b>999513</b>	4-burners (3,5+2x5+7)	-	900	900	850	20,5	G30	<b>1617,00</b>
	<b>999521</b>	4-burners (3,5+5+2x7)	-	900	900	850	22,5	G20	<b>1617,00</b>
	<b>999523</b>	4-burners (3,5+5+2x7)	-	900	900	850	22,5	G30	<b>1617,00</b>
	<b>999531</b>	4-burners (2x5+2x7)	-	900	900	850	24,0	G20	<b>1617,00</b>
	<b>999533</b>	4-burners (2x5+2x7)	-	900	900	850	24,0	G30	<b>1617,00</b>
	<b>999541</b>	4-burners (3,5+5+7+9)	-	900	900	850	24,5	G20	<b>1617,00</b>
	<b>999543</b>	4-burners (3,5+5+7+9)	-	900	900	850	24,5	G30	<b>1617,00</b>
	<b>999551</b>	4-burners (9+9+9+9)	-	900	900	850	36	G20	<b>1617,00</b>
	<b>999553</b>	4-burners (9+9+9+9)	-	900	900	850	36	G30	<b>1617,00</b>
	<b>999611</b>	6-burners (3,5+3x5+2x7)	-	1300	900	850	32,5	G20	<b>2278,50</b>
<b>999613</b>	6-burners (3,5+3x5+2x7)	-	1300	900	850	32,5	G30	<b>2278,50</b>	
<b>999621</b>	6-burners (3,5+2x5+2x7+9)	-	1300	900	850	36,5	G20	<b>2278,50</b>	
<b>999623</b>	6-burners (3,5+2x5+2x7+9)	-	1300	900	850	36,5	G30	<b>2278,50</b>	
2.	<b>970000</b>	Reducer overlay	-	200	200	-	-	-	<b>13,00</b>
	<b>970005</b>	WOK overlay	225	-	-	35	-	-	<b>47,00</b>

**REDUCER CAP**

- allows work with small utensils, recommended for 3,5kW and 5kW burners



4-BURNER FREESTANDING GAS TOP, SELF ASSEMBLY



- self assembly version with a robust structure
- legs and shelf connected by screws
- pilot flame
- cast iron grids
- removable dishwasher-safe bowl
- gas supply G20 or G30
- also available in gas versions G27 and G31
- adjustable feet



Self-assembly,  
robust structure



REDUCER CAP

- allows work with small utensils, recommended for 3.5kW and 5kW burners

2



WOK OVERLAY

- allows using WOK cookware directly on a gas stove grate
- made of stainless steel

3



No.	Code	Description	Ø mm	W mm	D mm	H mm	P kW	U	Price net (€)
1.	<b>978511</b>	4-burners (3,5+2x5+7)	-	800	700	850	20,5	G20	<b>1365,00</b>
	<b>978513</b>	4-burners (3,5+2x5+7)	-	800	700	850	20,5	G30	<b>1365,00</b>
	<b>978521</b>	4-burners (3,5+5+2x7)	-	800	700	850	22,5	G20	<b>1365,00</b>
	<b>978523</b>	4-burners (3,5+5+2x7)	-	800	700	850	22,5	G30	<b>1365,00</b>
	<b>978531</b>	4-burners (2x5+2x7)	-	800	700	850	24,0	G20	<b>1365,00</b>
	<b>978533</b>	4-burners (2x5+2x7)	-	800	700	850	24,0	G30	<b>1365,00</b>
2.	<b>970000</b>	Reducer overlay	-	200	200	-	-	-	<b>13,00</b>
3.	<b>970005</b>	WOK overlay	225	-	-	35	-	-	<b>47,00</b>



6-BURNER FREESTANDING GAS TOP, SELF ASSEMBLY



- self assembly version with a robust structure
- legs and shelf connected by screws
- pilot flame
- cast iron grids
- removable dishwasher-safe bowl
- gas supply G20 or G30
- also available in gas versions G27 and G31
- adjustable feet



Self-assembly,  
robust structure



REDUCER CAP

- allows work with small utensils, recommended for 3.5kW and 5kW burners



WOK OVERLAY

- allows using WOK cookware directly on a gas stove grate
- made of stainless steel



No.	Code	Description	Ø mm	W mm	D mm	H mm	P kW	U	Price net (€)
1.	<b>978611</b>	6-burners (3,5+3x5+2x7)	-	1200	700	850	32,5	G20	<b>1932,00</b>
	<b>978613</b>	6-burners (3,5+3x5+2x7)	-	1200	700	850	32,5	G30	<b>1932,00</b>
	<b>978621</b>	6-burners (3,5+2x5+2x7+9)	-	1200	700	850	36,5	G20	<b>1932,00</b>
	<b>978623</b>	6-burners (3,5+2x5+2x7+9)	-	1200	700	850	36,5	G30	<b>1932,00</b>
2.	<b>970000</b>	Reducer overlay	-	200	200	-	-	-	<b>13,00</b>
3.	<b>970005</b>	WOK overlay	225	-	-	35	-	-	<b>47,00</b>

## INDUCTION RANGETOPS

- designed for thermal treatment of food using induction suitable cookware
- induction technology is exceptionally power saving. It provides better working dynamics and lower energy consumption compared to gas or ceramic/iron cast electric hobs
- line of equipment that can be used as an element of the cooking line or as an independent heat treatment stations
- intended for small, medium and large gastronomy



### FREESTANDING INDUCTION COOKER

- ergonomic knobs
- laser-engraved front panel
- appliance protection system available via the control panel
- induction fields with a diameter of 225 mm and a power of 3.5 kW
- 9 power levels regulated by a knob
- cookware detection system
- remaining heat indicator
- devices without exhaust system allow to work with cookware of larger diameter
- efficient cooling system
- adjustable feet



Code	Description	W mm	D mm	H mm	P kW	U V	Price net (€)
979510	2 - induction fields	400	700	850	7	400	3349,50
979610	4 - induction fields	800	700	850	14	400	5449,50

Ceramic induction hobs



## FREESTANDING ELECTRIC HOB TOPS

- all types of cookware can be used
- equipment line dedicated as auxiliary elements of the cooking line or as independent heat treatment station
- intended for small and medium catering establishments and mass catering points



### FREESTANDING ELECTRIC HOB TOP

- work and power light
- cast iron hobs with a diameter of 220 mm and power of 2.6 kW
- available in 4 and 6-hob versions
- **pressed stove plate**
- adjustable feet



Code	Description	W mm	D mm	H mm	P kW	U V	Price net (€)
<b>979500</b>	4 hobs	800	700	850	10,4	400	<b>1134,00</b>
<b>979600</b>	6 hobs	1200	700	850	15,6	400	<b>1743,00</b>

## ELECTRIC FRY TOPS

- intended for direct thermal processing of food, electric grilling or frying
- line of equipment that can be used as an element of the cooking line or as an independent heat treatment stations
- devices adapted to individual technological requirements
- designed for small, medium and large gastronomy

INOX



PL POLISH PRODUCT

### FREESTANDING ELECTRIC FRY TOP

- ergonomic knobs
- laser-engraved front panel
- operation and power control
- appliance protection system available via the control panel
- working surface: 2200/4400 cm<sup>2</sup>
- two separate work zones for 800 mm plates
- working temperature range up to 300°C
- waste and grease discharge hole
- grease container
- elevated rear edges
- adjustable feet



Code	Description	W mm	D mm	H mm	P kW	U V	Price net (€)
<b>979301</b>	Single smooth	400	700	850	4,05	400	<b>1428,00</b>
<b>979302</b>	Single ribbed	400	700	850	4,05	400	<b>1522,50</b>
<b>979311</b>	Double smooth	800	700	850	8,10	400	<b>1995,00</b>
<b>979312</b>	Double ribbed	800	700	850	8,10	400	<b>2194,50</b>
<b>979313</b>	Double smooth/ribbed	800	700	850	8,10	400	<b>2194,50</b>

Ergonomic control panel



## ELECTRIC FRYER

- intended for direct thermal processing of food – electric frying
- line of equipment that can be used as an element of the cooking line or as an independent heat treatment stations
- designed for small, medium and large gastronomy



### FREESTANDING ELECTRIC FRYER

- ergonomic knobs
- laser-engraved front panel
- work and power light
- appliance protection system available via the control panel
- temperature range: up to 190°C
- system „strefy zimnej”
- protection that cuts off the power after removing the heater
- movable heating elements for easy cleaning
- bezpieczny spust frytury
- equipped with a basket with dimensions: 210x350x110 mm
- optional: the possibility of placing two baskets in one chamber (2x- 105x350x110 mm)
- adjustable feet



Possibility of placing two baskets in the compartment



Cold zone

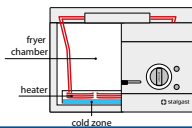

Code	Product	W mm	D mm	H mm	V liters	P kW	U V	Price net (€)
979250	Single fryer	400	700	850	10	9	400	1837,50
979991	Set of two baskets	105	350	110	-	-	-	225,00



## ELECTRIC BRATT PAN

- intended for cooking, stewing and frying food
- appliance dedicated for small and medium catering establishments, particularly recommended for mass catering points

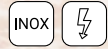

### ELECTRIC TILTING BRATT PAN

- large bowl working surface 0.27 m<sup>2</sup> for simultaneous preparation of several dishes
- manual bowl tilting for emptying its contents quickly and efficiently
- volume 40 l
- extremely stable appliance structure
- adjustable feet



Bowl made of stainless steel



Smooth temperature control



Reinforced base design



Additional equipment: shower set 651202



Code	Product	W mm	D mm	H mm	T °C	S chops/h	P kW	U V	Price net (€)
778002	Pan	700	786	912	up to 300	100	6,3	400	1522,50
651202	Shower set	-	-	-	-	-	-	-	75,00



## MULTIFUNCTIONAL CONVECTION OVEN



- intended for all cooking processes that do not require the compartment fogging feature
- appliances dedicated for small and medium catering establishments, particularly recommended for mass catering points

### MULTIFUNCTIONAL CONVECTION OVEN

- **3 operating modes:**
  - top heater (toaster function)
  - fan heater (convection function)
  - top and fan heater combined (convection function plus toaster)
- **intuitive control system**
- **glass oven door**
- oven compartment lighting
- 120 min. timer in continuous work function
- option to set together up to 3 ovens
- oven compartment size 660x445x285 mm
- three levels of rails
- stainless steel grill included
- work and power controls
- housing made of galvanized steel
- adjustable feet



Double glazed oven door



Stainless steel handle



3 oven operation modes



Stove connection kit



Adjustable feet



Code	Product	W mm	D mm	H mm	P kW	U V	Price net (€)
965001	Oven	800	640	600	6,54	400	1099,00
960001	Connection set	-	-	-	-	-	106,00



# COOKWARE

Lines of professional pots and pans as well as cast-iron utensils for heat treatment and serving hot dishes.

Gredil pots .....	55	Titanium-coated frying pans .....	59
Premium pots, High pot with tap .....	56-57	Frying pans with non-stick coating .....	60-63
Base for pots .....	57	Comfort frying pans .....	60-61
Complementary accessories .....	57	Comfort frying pans .....	64
Frying pans .....	58-63		
WOK pans .....	58		

## GREDIL POTS

- a line of stainless steel pots
- **multi-layer bottom**
- non-heating multi-point fixtures
- **lids included**
- **all pots have reinforced riveted handles**



1



2

### Multi-layer bottom

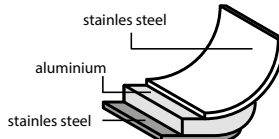

#### 1 HIGH POT

- with lid

Code	Ø mm	H mm	V' liters	Price net (€)
011245	240	200	9	50,60
011285	280	250	15,4	63,50
011325	320	260	20,9	82,40
011345	320	320	25,7	88,90
011365	360	360	36,6	114,00
011405	400	400	50,3	149,00
011455	450	450	71,6	219,00
011505	500	500	98,2	270,00

#### 2 MEDIUM POT

- with lid

Code	Ø mm	H mm	V' liters	Price net (€)
012285	280	180	11,1	63,20
012325	320	200	16,1	77,60
012365	360	220	22,4	106,00
012405	400	260	32,6	131,00
012455	450	360	57,3	199,00

# PREMIUM LINE POTS



- a line of stainless steel pots
- **multi-layer capsule bottom**
- non-heating multi-point fixtures
- **possibility to buy additional lids**
- **all pots from Ø360 mm have reinforced riveted handles**

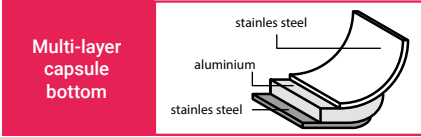

## HIGH POT

- with lid

Code	Ø mm	H mm	V* liters	Price net (€)
<b>011162</b>	160	120	2,5	<b>33,78</b>
<b>011202</b>	200	200	6,3	<b>48,93</b>
<b>011242</b>	240	200	9,0	<b>60,87</b>
<b>011282</b>	280	250	15,4	<b>77,87</b>
<b>011322</b>	320	260	20,9	<b>120,51</b>
<b>011342</b>	320	320	25,7	<b>129,78</b>
<b>011362</b>	360	360	36,6	<b>163,77</b>
<b>011402</b>	400	400	50,3	<b>211,15</b>
<b>011452</b>	450	450	71,6	<b>284,28</b>
<b>011502</b>	500	500	98,2	<b>346,08</b>

## MEDIUM POT

- with lid

Code	Ø mm	H mm	V* liters	Price net (€)
<b>012162</b>	160	95	1,9	<b>34,30</b>
<b>012202</b>	200	140	4,4	<b>42,64</b>
<b>012242</b>	240	160	7,2	<b>53,56</b>
<b>012282</b>	280	180	11,1	<b>67,77</b>
<b>012322</b>	320	200	16,1	<b>108,15</b>
<b>012362</b>	360	220	22,4	<b>130,81</b>
<b>012402</b>	400	300	37,7	<b>173,04</b>
<b>012452</b>	450	360	57,3	<b>254,41</b>
<b>012502</b>	500	320	62,8	<b>254,41</b>

## LOW POT

- with lid

Code	Ø mm	H mm	V* liters	Price net (€)
<b>013202</b>	200	105	3,3	<b>41,30</b>
<b>013242</b>	240	110	5,0	<b>48,00</b>
<b>013282</b>	280	130	8,0	<b>62,52</b>
<b>013322</b>	320	160	12,9	<b>101,87</b>
<b>013362</b>	360	180	18,3	<b>123,60</b>
<b>013402</b>	400	250	31,4	<b>167,89</b>



**HIGH POT WITH TAP**

- multi-layer sandwich bottom ensures even distribution of heat
- solid drain tap
- reinforced upper edge and riveted handles
- lid included



Code	Ø mm	H mm	V liters	Price net (€)
<b>011410</b>	400	400	50,3	<b>172,00</b>

**STEWING POT**

- with lid



Code	Ø mm	H mm	V* liters	Price net (€)
<b>016362</b>	360	110	11,2	<b>110,21</b>

**BASE FOR POTS**

- welded structure



Code	W mm	D mm	H mm	Price net (€)
<b>010404</b>	400	400	450	<b>154,00</b>
<b>010505</b>	500	500	450	<b>169,00</b>
<b>010606</b>	600	600	450	<b>191,00</b>

**COOKING INSERTS**

- the set includes 4 inserts
- suitable for low pot 013322 (str. 63)



Code	Ø mm	H mm	Price net (€)
<b>020320</b>	300	180	<b>98,00</b>

**SAUCEPAN**

- with lid



Code	Ø mm	H mm	V* liters	Price net (€)
<b>015162</b>	160	95	1,9	<b>30,39</b>
<b>015202</b>	200	105	3,3	<b>37,90</b>
<b>015242</b>	240	110	5,0	<b>46,25</b>
<b>015282</b>	280	130	8,0	<b>63,55</b>

**SAUCEPAN**

- without lid



Code	Ø mm	H mm	V* liters	Price net (€)
<b>015164</b>	160	95	1,9	<b>23,07</b>
<b>015204</b>	200	105	3,3	<b>27,91</b>
<b>015244</b>	240	110	5,0	<b>37,49</b>
<b>015284</b>	280	130	8,0	<b>49,23</b>

**SAUCEPAN**

- without lid



Code	Ø mm	H mm	V* liters	Price net (€)
<b>017202</b>	200	65	1,2	<b>25,54</b>
<b>017242</b>	240	75	2,2	<b>31,00</b>

## PANS

- dedicated to frying
- induction compatible
- fast and even heat distribution over the entire surface



### PAN

- pans 014323, 014363 and 014403 have an additional handle



Code	Ø mm	H mm	Price net (€)
<b>014203</b>	200	40	<b>22,97</b>
<b>014243</b>	240	42	<b>29,36</b>
<b>014283</b>	280	48	<b>33,48</b>
<b>014323</b>	320	52	<b>51,81</b>
<b>014363</b>	360	65	<b>66,13</b>
<b>014403</b>	400	70	<b>85,39</b>

## WOK PAN

- model 037400 satin steel
- model 037401 polished steel



1



2

Handle attachment  
037400



Handle attachment  
037401



No.	Code	Ø mm	H mm	L (handle) mm	Price net (€)
1.	<b>037400</b>	400	120	200	<b>21,80</b>
2.	<b>037401</b>	400	120	185	<b>32,20</b>



**NON-STICK PAN**

- Teflon-coated

Code	Ø mm	H mm	Price net (€)
<b>014244</b>	240	42	<b>41,10</b>
<b>014284</b>	280	48	<b>51,40</b>
<b>014324</b>	320	52	<b>72,92</b>

**CARBON STEEL PAN**

- with a non-stick coating

Code	Ø mm	H mm	Price net (€)
<b>037280</b>	280	40	<b>20,30</b>

**TITANIUM-COATED PANS****TITANIUM-COATED PAN**

- pans made of hard titanium-coated aluminum
- stainless steel non-warming handle



Pan bottom



Code	Ø mm	H mm	Price net (€)
<b>034240</b>	240	55	<b>63,00</b>
<b>034280</b>	280	55	<b>72,00</b>
<b>034320</b>	320	55	<b>82,00</b>

**TITANIUM-COATED PAN**

- pans made of hard titanium-coated aluminum
- stainless steel non-warming handle



Pan bottom



Code	Ø mm	H mm	Price net (€)
<b>034241</b>	240	50	<b>70,30</b>
<b>034281</b>	280	55	<b>80,70</b>



# ALUMINUM PANS WITH NON-STICK COATING, COMFORT PLUS



- dedicated to frying
- induction compatible
- fast and even heat distribution over the entire surface
- suitable for frying with a small amount of fat
- ergonomic, non-heating handles

Pan bottom



## PANCAKE PAN

AI



Code	Ø mm	H mm	V liters	Price net (€)
<b>018247</b>	240	28	0,9	<b>44,70</b>
<b>018287</b>	280	30	1,3	<b>53,20</b>

## PAN

AI



Code	Ø mm	H mm	V liters	Price net (€)
<b>018246</b>	240	47	1,6	<b>47,70</b>
<b>018286</b>	280	51	2,4	<b>55,90</b>
<b>018326</b>	320	55	3,5	<b>64,90</b>
<b>018366</b>	360	59	4,8	<b>87,20</b>
<b>018406</b>	400	63	6,3	<b>106,00</b>

## WOK PAN

AI



Code	Ø mm	H mm	V liters	Price net (€)
<b>018261</b>	280	93	4,2	<b>63,00</b>
<b>018321</b>	320	95	5,3	<b>72,00</b>
<b>018361</b>	360	120	8,5	<b>105,00</b>

## ALUMINUM PANS WITH NON-STICK COATING, COMFORT

- dedicated to frying
- fast and even heat distribution over the entire surface
- suitable for frying with a small amount of fat
- ergonomic, non-heating handles



### PANCAKE PAN

Code	Ø mm	H mm	V liters	Price net (€)
<b>018264</b>	260	30	1,1	<b>39,03</b>
<b>018304</b>	300	31	1,5	<b>46,17</b>

Al



### PAN

Code	Ø mm	H mm	V liters	Price net (€)
<b>018204</b>	200	42	1,0	<b>29,30</b>
<b>018244</b>	240	47	1,6	<b>37,90</b>
<b>018284</b>	280	51	2,4	<b>43,80</b>
<b>018324</b>	320	53	2,9	<b>51,20</b>
<b>018364</b>	360	59	4,8	<b>72,40</b>
<b>018404</b>	400	63	6,3	<b>87,60</b>

Al



## ALUMINUM PANS WITH NON-STICK COATING, COMFORT GRAPHITE



### PANCAKE PAN WITH GRANITE COATING

Code	Ø mm	H mm	V liters	Price net (€)
<b>018263</b>	260	29	1,1	<b>37,90</b>
<b>018303</b>	300	31	1,5	<b>45,80</b>

Al



### PAN WITH GRANITE COATING

Code	Ø mm	H mm	V liters	Price net (€)
<b>018203</b>	200	42	0,9	<b>27,40</b>
<b>018243</b>	240	47	1,6	<b>36,00</b>
<b>018283</b>	280	51	2,4	<b>44,20</b>
<b>018323</b>	320	55	3,5	<b>52,40</b>
<b>018363</b>	360	59	4,8	<b>73,50</b>
<b>018403</b>	400	63	6,4	<b>90,00</b>

Al



Straight handle in model 018363 and 018403



# ALUMINUM PANS WITH NON-STICK COATING, PLATINUM



- aluminum pans coated with DUPONT® Teflon®
- three-layer non-stick coating, scratch-resistant
- steel handle made of epoxy-coated steel, provides high thermal strength
- distributes heat over the entire surface quickly and evenly
- allows frying with a small amount of fat

## 3-layer Teflon coating

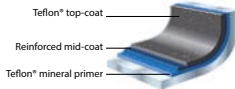

### 1 PAN

- induction layer on the bottom of the pan

Code	Ø mm	H mm	V liters	Price net (€)
035200	200	35	0,8	21,70
035240	240	45	2,0	24,90
035280	280	50	3,0	32,40



### 2 PANCAKE PAN

- induction layer on the bottom of the pan

Code	Ø mm	H mm	Price net (€)
032260	255/215	17	27,60



## Epoxy steel handle



### 1 PAN

- pans with a diameter of 200 to 280 mm have a wall thickness of 4 mm
- pans with a diameter of 320 mm have a wall thickness of 5 mm

Code	Ø mm	H mm	V liters	Price net (€)
035201	200	35	0,8	17,50
035241	240	40	1,2	22,10
035281	280	45	2,0	28,90
035321	320	50	3,0	34,40
035361	360	55	4,0	45,90
035401	400	60	5,0	58,80



### 2 PANCAKE PAN

Code	Ø mm	H mm	Price net (€)
032261	255 / 215	17	27,40
032301	292 / 255	17	31,00



# ALUMINUM PANS WITH NON-STICK COATING

- pans made of cast aluminum coated with a non-stick teflon coating
- handle made of epoxy-coated steel
- distributes heat over the entire surface quickly and evenly
- allows frying with a small amount of fat

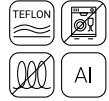

## PAN

Code	Ø mm	H mm	V liters	Price net (€)
<b>031200</b>	200	40	0,9	<b>32,01</b>
<b>031240</b>	240	40	1,3	<b>38,17</b>
<b>031280</b>	280	45	2,0	<b>43,67</b>
<b>031320</b>	320	50	3,0	<b>54,89</b>
<b>031360</b>	360	50	4,0	<b>72,38</b>
<b>031400</b>	400	55	5,0	<b>84,37</b>



## DEEP PAN

Code	Ø mm	H mm	V liters	Price net (€)
<b>036200</b>	200	60	1,6	<b>55,02</b>
<b>036240</b>	240	65	2,6	<b>59,54</b>
<b>036280</b>	280	75	3,8	<b>74,03</b>



## PANCAKE PAN

Code	Ø mm	H mm	V liters	Price net (€)
<b>032250</b>	250	20	0,8	<b>33,39</b>
<b>032280</b>	280	20	1,1	<b>36,23</b>



## FISH PAN

Code	W mm	D mm	H mm	V liters	Price net (€)
<b>034380</b>	380	260	40	3,0	<b>102,69</b>



# CAST IRON COOKWARE



- cast iron dishes with a black surface obtained thanks to the firing process
- ideal for serving hot dishes
- the thick bottom slows down the cooling of food
- double-sided grill hob recommended for standard gas and electric burners (perfect for preparing American and Argentinian steaks)
- cast ironware should be rinsed and dried before use; after use, wash them while still warm, preferably with dishwashing liquid, using a brush; always lubricate with vegetable oil after drying

## 1 GRILL PAN

- square

Code	W mm	D mm	H mm	M kg	Price net (€)
<b>049003</b>	230	230	35	2,6	<b>21,10</b>



1

## 2 PLATTER

- wooden stand and cast iron handle included
- base dimensions: 280 x 155 mm

Code	W mm	D mm	H mm	M kg	Price net (€)
<b>049004</b>	240	140	25	1,13	<b>16,20</b>



2

## 3 GRILL HOB

- double-sided (smooth/grooved)

Code	W mm	D mm	H mm	M kg	Price net (€)
<b>049002</b>	480	260	20	5,0	<b>27,20</b>



3

## PLATTER

- black cast iron mini-dish, ideal for serving hot meals
- black color obtained in the firing process
- maintains high temperature of the served dishes over a long time
- cast iron vessels require maintenance by greasing the surface with edible oil
- wooden stand included (WxD: 310x160 mm)



Code	W mm	D mm	H mm	V liters	Price net (€)
<b>049012</b>	210	150	55	0,8	<b>25,70</b>





# KITCHEN UTENSILS

The most frequently used kitchen tools in everyday work in catering, providing excellent support for every food preparation process.

Buckets.....	66	Dispensers, racks for sauces .....	81
Salad spinner .....	67	Tweezers, tongs, openers.....	82-83
Bowls, tubs .....	68	Decoration knives and accessories.....	84
Sieves, colanders .....	69-70	Can opener .....	85
Serving accessories .....	71-75	Manual vegetable slicing appliances.....	85
Spatulas, whisks.....	75-76	Scales.....	86-88
Scoops, pitchers, measuring cups.....	77-78	Thermometers .....	89
Displays.....	80-81		

PREMIUM BUCKETS OF STAINLESS STEEL

- scale inside the buckets 10, 12, 15 l
- 10 mm edge

Lindén

INOX



BUCKET

Code	Ø mm	H mm	V liters	Price net (€)
091061	235 / 157	245	7	56,40
091101	280 / 200	245	10	67,30
091151	305 / 200	310	15	83,00



RING BUCKET

Code	Ø mm	H mm	V liters	Price net (€)
092101	280 / 202	265	10	94,00
092151	305 / 202	330	15	112,00



LID

- 093101 suitable for buckets 091101 and 092101
- 093151 suitable for buckets 091151 and 092151

Code	Ø mm	Price net (€)
093101	280	26,30
093151	305	30,50

STAINLESS STEEL BUCKETS

- scale inside the bucket
- ring buckets can be stacked



INOX



BUCKET

Code	Ø mm	H mm	V liters	Price net (€)
091063	230/155	250	7	42,30
091103	293/205	245	10	42,30
091123	295/230	275	12	52,90
091153	300/200	340	15	58,90



RING BUCKET

Code	Ø mm	H mm	V liters	Price net (€)
092103	275/200	285	10	56,70
092123	290/200	305	12	64,00
092153	300/200	354	15	63,90



LID

- 093103 suitable for buckets 091103 and 092103
- 093123 suitable for buckets 091123 and 092123
- 093153 suitable for buckets 091153 and 092153

Code	Ø mm	Price net (€)
093103	275	12,30
093123	290	14,40
093153	300	18,10



Water drainage hose



Removable basket



**SALAD SPINNER**

- made of durable plastic
- water drainage system



PP



Code	Ø mm	H mm	V liters	Price net (€)
<b>072190</b>	420	580	19	<b>196,00</b>

**BUCKET**



- made of durable white polyethylene
- thermal endurance of -40°C to 90°C
- internal graduation of up to 10 l
- does not absorb odors
- no lid



Code	W mm	D mm	V liters	Price net (€)
<b>094100</b>	290	290	12,0	<b>15,00</b>

**BOWL**

- polished steel

INOX

Code	Ø mm	H mm	V liters	Price net (€)
<b>082180</b>	180	80	1,2	<b>4,80</b>
<b>082200</b>	200	80	1,6	<b>6,55</b>
<b>082240</b>	240	100	2,7	<b>8,02</b>
<b>082280</b>	280	100	4,0	<b>9,08</b>
<b>082300</b>	300	110	5,0	<b>10,30</b>
<b>082320</b>	320	110	6,0	<b>12,10</b>
<b>082360</b>	360	130	8,0	<b>15,30</b>



**BOWL**

- polished steel
- the bowls' diameter measured with the edge

INOX

Code	Ø mm	H mm	V liters	Price net (€)
<b>082400</b>	400	110	8,0	<b>18,10</b>
<b>082500</b>	500	130	14,0	<b>26,20</b>
<b>082550</b>	550	145	19,0	<b>29,70</b>
<b>082600</b>	600	160	27,0	<b>41,40</b>
<b>082700</b>	700	185	45,0	<b>68,10</b>
<b>082800</b>	800	205	65,0	<b>97,90</b>
<b>082900</b>	900	225	90,0	<b>126,00</b>



**BOWL**

- satin steel

INOX

Code	Ø mm	H mm	V liters	Price net (€)
<b>081161</b>	160	75	1	<b>8,41</b>
<b>081201</b>	200	90	2	<b>13,70</b>
<b>081241</b>	240	110	3.5	<b>17,60</b>
<b>081281</b>	280	132	6.2	<b>23,10</b>
<b>081301</b>	300	140	7	<b>25,00</b>
<b>081351</b>	350	160	11.5	<b>34,80</b>
<b>081401</b>	400	180	16.5	<b>45,00</b>



**TUB**

- satin steel
- with handles

INOX

Code	Ø mm	H mm	V liters	Price net (€)
<b>083400</b>	400	185	14,5	<b>76,89</b>
<b>083450</b>	450	200	21,0	<b>96,58</b>
<b>083500</b>	500	220	28,0	<b>116,60</b>



SIEVE



INOX



Code	Ø mm	L mm	Price net (€)
<b>076120</b>	120	140	<b>5,06</b>
<b>076150</b>	150	150	<b>6,58</b>
<b>076180</b>	180	170	<b>7,19</b>
<b>076200</b>	200	180	<b>8,20</b>

TERRINE MOLD

INOX

- shape of molds:  
098010 -   
098020 - 



Code	W mm	D mm	H mm	V liters	Price net (€)
<b>098010</b>	400	65	35	0,6	<b>43,40</b>
<b>098020</b>	400	50	40	0,4	<b>42,90</b>

DENSE-MESH CONE SIEVE

INOX

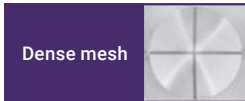

Code	Ø mm	H mm	Price net (€)
<b>075200</b>	200	150	<b>70,70</b>
<b>075240</b>	240	180	<b>91,00</b>

CONE SIEVE

INOX

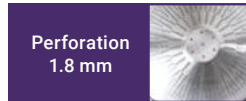

Code	Ø mm	H mm	Price net (€)
<b>075201</b>	200	170	<b>17,00</b>
<b>075241</b>	240	210	<b>20,10</b>

SIFTING MESH

- mesh approx. 1 mm

INOX



Code	Ø mm	H mm	Price net (€)
<b>073200</b>	210	70	<b>16,80</b>
<b>073250</b>	250	75	<b>19,70</b>
<b>073300</b>	310	75	<b>31,00</b>

4 SIEVING MESH KIT

- 4 different mesh diameters of approx:  
0,75 x 0,75 mm  
1 x 1 mm  
2 x 2 mm  
3 x 3 mm

INOX

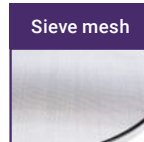

Code	Ø mm	Price net (€)
<b>073210</b>	210	<b>26,50</b>

**COLANDER**

- stainless steel handle
- perforation 3.4 mm

INOX



Code	Ø mm	L mm	Price net (€)
<b>077220</b>	220	260	<b>86,80</b>
<b>077260</b>	260	260	<b>98,50</b>

**SIEVE**

- wooden handle
- L - handle length

INOX



Code	Ø mm	L mm	Price net (€)
<b>074300</b>	300	430	<b>28,10</b>
<b>074350</b>	350	430	<b>33,20</b>

**SLOTTED TUB**

- polished steel

INOX



Code	Ø mm	H mm	Price net (€)
<b>072363</b>	360	190	<b>62,40</b>
<b>072403</b>	400	220	<b>74,70</b>

**COLANDER**

- with handles

INOX



Code	Ø mm	H mm	Price net (€)
<b>071360</b>	360 / 200	220	<b>51,30</b>
<b>071410</b>	375 / 175	185	<b>24,50</b>

**SLOTTED TUB**

- satin steel

INOX



Code	Ø mm	H mm	Price net (€)
<b>072452</b>	450 / 290	240	<b>156,00</b>
<b>072502</b>	500 / 330	260	<b>164,00</b>



# MONOBLOCK KITCHEN TOOLS



- professional lades and monoblock slotted spoons
- weldless, made of one piece of steel
- easy to clean
- ergonomic bent suspension bracket

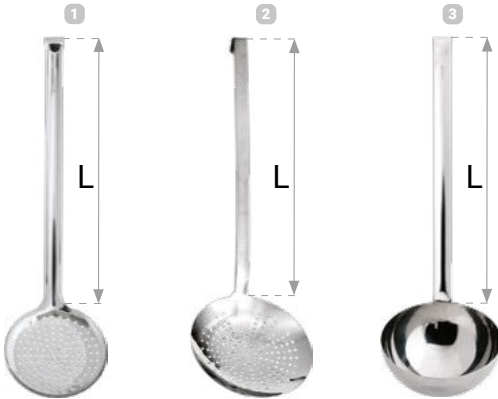
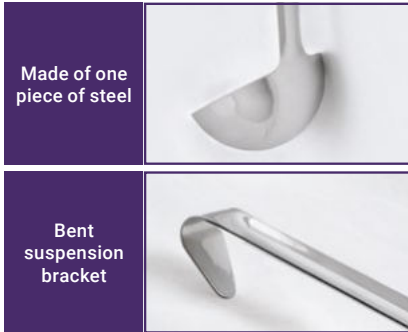

## 1 SLOTTED SPOON

Code	Ø mm	L mm	Price net (€)
<b>324101</b>	100	325	<b>6,23</b>
<b>324121</b>	120	360	<b>8,56</b>
<b>324141</b>	140	385	<b>10,90</b>
<b>324161</b>	160	415	<b>14,60</b>
<b>324201</b>	200	480	<b>25,30</b>

## 2 SLOTTED SPOON

Code	Ø mm	L mm	Price net (€)
<b>324100</b>	100	305	<b>7,90</b>
<b>324120</b>	120	360	<b>11,70</b>
<b>324140</b>	140	380	<b>14,20</b>
<b>324160</b>	160	415	<b>17,80</b>

## 3 LADLE

Code	Ø mm	L mm	V liters	Price net (€)
<b>323061</b>	60	275	0,06	<b>4,09</b>
<b>323081</b>	80	295	0,12	<b>6,63</b>
<b>323101</b>	100	340	0,25	<b>9,25</b>
<b>323121</b>	120	365	0,40	<b>12,50</b>
<b>323141</b>	145	395	0,75	<b>16,70</b>
<b>323201</b>	200	480	2,00	<b>33,90</b>

## 4 LADLE

Code	Ø mm	L mm	V liters	Price net (€)
<b>323062</b>	65	315	0,07	<b>7,40</b>
<b>323082</b>	80	345	0,13	<b>9,25</b>
<b>323092</b>	90	362	0,20	<b>10,40</b>
<b>323102</b>	100	380	0,25	<b>12,50</b>
<b>323122</b>	120	420	0,45	<b>15,20</b>
<b>323142</b>	140	440	0,67	<b>18,00</b>
<b>323162</b>	160	474	1,00	<b>20,20</b>
<b>323182</b>	180	500	1,50	<b>25,60</b>



## MONOBLOCK KITCHEN TOOLS

INOX

No.	Code	Product	L mm	V liters	Price net (€)
1.	<b>320010</b>	Ladle	400	0,18	<b>11,20</b>
2.	<b>320020</b>	Turning fork	400	-	<b>9,02</b>
3.	<b>320030</b>	Perforated spoon	400	-	<b>9,02</b>
4.	<b>320040</b>	Serving spoon	400	-	<b>9,02</b>

No.	Code	Product	L mm	V liters	Price net (€)
5.	<b>320060</b>	Spaghetti spoon	400	-	<b>9,02</b>
6.	<b>320070</b>	Slotted spoon	400	-	<b>9,02</b>
7.	<b>320080</b>	Spatula	400	-	<b>9,02</b>

## MONOBLOCK KITCHEN TOOLS

INOX



No.	Code	Product	L mm	Price net (€)
1.	<b>312340</b>	Fish spatula	340	<b>31,60</b>
2.	<b>311500</b>	Turning fork	500	<b>37,40</b>
3.	<b>311100</b>	Serving spoon	460	<b>9,46</b>

# KITCHEN TOOLS

• round handle

INOX



7



8



9



10



11



6 hooks

12

No.	Code	Product	Ø mm	L mm	Price net (€)
1.	<b>321010</b>	Slotted spoon	-	345	<b>6,18</b>
2.	<b>321020</b>	Turning fork	-	320	<b>4,61</b>
3.	<b>321030</b>	Serving spoon	-	328	<b>4,61</b>
4.	<b>321040</b>	Ladle	70	280	<b>5,32</b>
	<b>321050</b>	Ladle	85	310	<b>5,91</b>
5.	<b>321060</b>	Spaghetti spoon	-	307	<b>5,56</b>
6.	<b>321070</b>	Spatula	-	320	<b>5,36</b>
7.	<b>321160</b>	Wire whisk with ball (20 wires)	-	270	<b>3,42</b>
8.	<b>321100</b>	Vegetable peeler	-	190	<b>7,33</b>
9.	<b>321110</b>	Vegetable peeler	-	165	<b>6,16</b>
10.	<b>321120</b>	Straight roller blade	57	190	<b>5,86</b>
11.	<b>321150</b>	Can opener	-	220	<b>14,40</b>
12.	<b>321001</b>	Hanger with hooks	-	400	<b>11,30</b>

## SERVING ACCESSORIES



- professional set of serving accessories
- made of high-polished stainless steel with monoblock technology
- no welds and bends, made of one piece of steel
- easy to clean
- handle thickness 2.7 mm



No.	Code	Product	L mm	V liters	Price net (€)
1.	<b>420012</b>	Perforated spoon	310	-	<b>7,16</b>
2.	<b>420032</b>	Serving spoon	315	-	<b>7,80</b>

No.	Code	Product	L mm	V liters	Price net (€)
3.	<b>420052</b>	Ladle	310	0,08	<b>10,10</b>

## SERVING ACCESSORIES



- made of durable plastic reinforced with fiberglass
- perfect for Teflon coatings
- suitable for dishwashing
- suitable for steaming
- high thermal resistance up to +220°C



No.	Code	Product	L mm	Price net (€)
1.	<b>325120</b>	Tongs	250	<b>6,40</b>
	<b>325130</b>	Tongs	320	<b>8,87</b>
2.	<b>325030</b>	Perforated spoon	350	<b>9,39</b>
3.	<b>325040</b>	Serving spoon	350	<b>9,61</b>

No.	Code	Product	Ø mm	L mm	V liters	Price net (€)
4.	<b>325010</b>	Ladle	90	310	0,11	<b>9,61</b>
5.	<b>325070</b>	Slotted spoon	-	350	-	<b>8,87</b>
6.	<b>325080</b>	Spatula	-	350	-	<b>9,39</b>

# SPATULAS



**1 TURNER**

- plastic handle
- A = 115 mm, B = 90 mm

Code	L mm	Price net (€)
503205	280	9,39

**2 ANGLE TURNER**

- plastic handle
- A = 200 mm, B = 75 mm

Code	L mm	Price net (€)
503235	370	7,21

**5 TURNER**

- non-slip handle
- A = 90 mm, B = 75 mm

Code	L mm	Price net (€)
270150	150	59,10

**6 TURNER**

- non-slip handle
- A = 200 mm, B = 80 mm

Code	L mm	Price net (€)
270260	260	74,40

**7 TURNER**

- non-slip handle
- A = 135 mm, B = 85 mm

Code	L mm	Price net (€)
264170	170	50,00

**8 ANGLE TURNER**

- wooden handle
- A = 140 mm, B = 100 mm

Code	W mm	L mm	Price net (€)
503200	100	300	7,82

**11 SPATULA FOR CONFECTIONERY**

- plastic handle

Code	L mm	Price net (€)
261090	100	6,72

**9 TURNER**

- wooden handle
- A = 195 mm, B = 70 mm

Code	W mm	L mm	Price net (€)
503230	70	365	4,98

**10 TURNER**

- wooden handle
- perforated
- A = 200 mm, B = 70 mm

Code	W mm	L mm	Price net (€)
503240	70	365	5,73



**1 WHISK**

- steel working section
- plastic handgrip

Code	L mm	Price net (€)
313250	250	7,17
313350	350	8,58
313450	450	9,31
313550	550	10,70

**2 WHISK**

Code	L mm	Price net (€)
313300	300	4,57
313400	400	6,08
313500	500	7,96
313600	600	8,29

**3 SLOTTED SPOON**

Code	Ø mm	L mm	Price net (€)
310160	160	350	39,20
310200	200	450	53,60

**4 SLOTTED SPOON**

Code	Ø mm	L mm	Price net (€)
310161	160	470	9,40
310201	200	590	12,20
310241	240	570	14,40

**5 FRIES SCOOP**

Code	Price net (€)
319000	24,60

**6 PADDLE**

- thickness 20 mm

Code	L mm	Price net (€)
314075	700	33,20
314100	1000	37,00
314125	1250	42,50

**7 COOKING PADDLE**

- made of stainless steel

Code	L mm	Price net (€)
314130	1460	37,50





### SCOOP



Code	V liters	Price net (€)
<b>304072</b>	0,47	<b>5,83</b>
<b>304073</b>	0,68	<b>10,20</b>

### SCOOP



Code	V liters	Price net (€)
<b>304017</b>	0,125	<b>15,90</b>
<b>304033</b>	0,150	<b>19,80</b>
<b>304060</b>	0,450	<b>22,00</b>
<b>304101</b>	0,650	<b>26,70</b>

### FUNNEL

- sieve included
- lower diameter 17 mm



Code	Ø mm	Price net (€)
<b>301151</b>	150	<b>8,87</b>

### SCOOP



Code	Ø mm	V liters	Price net (€)
<b>304102</b>	100	1	<b>22,60</b>

## MEASURING SPOON

- 4 sizes included:  
1/4 teaspoon (1.25 ml)  
1/2 teaspoon (2.5 ml)  
1 teaspoon (5 ml)  
1 spoon (15 ml)
- volumes visible on holders

INOX



Code	V liters	Price net (€)
<b>506010</b>	0,00125 - 0,015	<b>7,35</b>

## MEASURING CUPS

- 4 sizes included:  
1/4 cup (60 ml)  
1/3 cup (80 ml)  
1/2 cup (125 ml)  
1 cup (250 ml)
- volumes visible on holders

INOX



Code	V liters	Price net (€)
<b>506015</b>	0,06-0,25	<b>10,50</b>

## MEASURING JUG

- transparent
- scale



PP



Code	V liters	Price net (€)
<b>506053</b>	0,50	<b>1,74</b>
<b>506103</b>	1,00	<b>2,57</b>
<b>506203</b>	2,00	<b>4,09</b>
<b>506303</b>	3,00	<b>5,87</b>
<b>506503</b>	5,00	<b>9,08</b>

## MEASURING JUG

- scale inside the pitcher

INOX



Code	V liters	Price net (€)
<b>506052</b>	0,5	<b>11,20</b>
<b>506102</b>	1,0	<b>14,30</b>
<b>506202</b>	2,0	<b>22,90</b>

## 4 - SIDED GRATER

- non-slip base
- convenient handle

INOX



Code	W mm	D mm	H mm	Price net (€)
<b>302191</b>	100	80	230	<b>21,50</b>

## HEXAGONAL GRATE

INOX



Code	H mm	Price net (€)
<b>302190</b>	190	<b>8,29</b>

BONING STRIP

AI



Code	L mm	Price net (€)
<b>099102</b>	450	<b>8,62</b>
<b>099103</b>	600	<b>11,60</b>
<b>099104</b>	900	<b>17,10</b>
<b>099105</b>	1200	<b>22,90</b>

RECEPTION BELL

• chromed

Cr

BONING SKEWER

INOX



Code	Ø mm	H mm	Price net (€)
<b>398000</b>	85	60	<b>5,46</b>

RECEIPT TRAY

INOX



Code	W mm	D mm	Price net (€)
<b>398150</b>	150	110	<b>3,62</b>

Code	Ø mm	H mm	Price net (€)
<b>398100</b>	80	150	<b>2,99</b>



## DISPLAY FOR GN CONTAINERS

INOX

- 815200 - volume 3 x GN 1/6 max 150 mm
- 815250 - volume 3 x GN 1/6 and 2 x GN 1/9 max 150 mm
- 815240 - volume 5 x GN 1/4 max 150 mm
- containers and lids sold separately



1



2

PL STALGAST RADOM

3



No.	Code	W mm	D mm	H mm	Price net (€)
1.	<b>815200</b>	510	230	230	<b>69,00</b>
2.	<b>815250</b>	730	230	230	<b>89,00</b>
3.	<b>815240</b>	840	300	275	<b>99,00</b>

## SHELF WITH SPICE CONTAINERS

- volume 5xGN 1/9 65mm

PL STALGAST RADOM

INOX



Code	W mm	D mm	H mm	Price net (€)
<b>815500</b>	629	200	250	<b>116,00</b>



**SAUCE DISPENSER WITH PUMP**



- for cold sauces only
- container made of semi-transparent polypropylene with ColorClip system
- does not absorb odors and flavors
- the volumes given are approximate

Code	Description	W mm	D mm	H mm	V liters	Price net (€)
<b>065164</b>	GN 1/4	265	162	190	4,3	<b>34,50</b>
<b>065166</b>	GN 1/6	176	162	190	2,6	<b>26,00</b>
<b>065169</b>	GN 1/9	176	108	190	1,5	<b>24,90</b>

**SAUCE DISPENSER**

- for cold sauces only



Code	Colour	Ø mm	H mm	V liters	Price net (€)
<b>065352</b>	●	55	210	0,35	<b>1,09</b>
<b>065722</b>	●	70	240	0,70	<b>1,30</b>
<b>065721</b>	●	70	240	0,70	<b>1,30</b>
<b>065723</b>	○	70	240	0,70	<b>1,30</b>

**FIFO SAUCE DISPENSER**

- made of slightly transparent plastic
- wide opening with a cap for easy filling
- silicone non-drip system for precise sauce dispensing
- fifo system ensuring safety and product control
- easy to clean
- for cold sauces only



Code	Ø mm	H mm	V liters	Price net (€)
<b>065004</b>	75	208	0,710	<b>5,76</b>

**DISPLAYS**



1



2



3

No.	Code	Product	Ø mm	W mm	D mm	H mm	Price net (€)
1.	<b>348050</b>	Sandwich display with 5 compartments	-	347	120	52	<b>19,00</b>
2.	<b>065105</b>	Display for sauce dispensers 5 bottles	5x75	435	110	120	<b>45,30</b>
3.	<b>348030</b>	Rack for 3 hot dogs	-	217	110	118	<b>29,50</b>

PASTRY TONGS



Code	L mm	Price net (€)
423223	120	5,67
423283	280	5,74

CAKE TONGS



Code	L mm	Price net (€)
423285	280	6,31

GRILL TONGS



Code	L mm	Price net (€)
423224	220	3,88
423284	280	4,41

SPAGHETTI TONGS



Code	L mm	Price net (€)
421060	200	3,44

ROAST TONGS



Code	L mm	Price net (€)
421040	210	4,81

UNIVERSAL TONGS



Code	L mm	Price net (€)
422241	240	3,72
422301	300	4,27
422401	400	4,95

UNIVERSAL TONGS



Code	L mm	Price net (€)
422302	300	7,55
422402	400	8,99

BREAD TONGS



Code	L mm	Price net (€)
421050	210	5,96

ICE TONGS



Code	L mm	Price net (€)
471101	180	2,39

UNIVERSAL TONGS



Code	L mm	Price net (€)
422243	230	4,57
422303	300	4,97

POLYCARBONATE



Code	L mm	Price net (€)
425110	230	2,47

POLYCARBONATE TONGS



Code	L mm	Price net (€)
425410	230	2,49



**EGG CUTTER**

- 2 blades
- able to cut into quarters and slices (~ 5 mm)



Code	W mm	D mm	H mm	Price net (€)
<b>332071</b>	120	95	40	<b>14,00</b>

**GARLIC SQUEEZER**

- made of akulon
- easy to clean modular design



Code	L mm	Price net (€)
<b>332030</b>	180	<b>11,50</b>

**LEMON SQUEEZER**

- made of painted aluminum



AI



Code	Ø mm	L mm	Price net (€)
<b>474000</b>	55	208	<b>10,20</b>

**RICE PORTIONER**

- the portioner may not be used with harder products such as ice cream
- weight approx. 70g, 1/12



Code	L mm	Price net (€)
<b>531121</b>	250	<b>19,00</b>

**FISH SCRAPER**



Code	L mm	Price net (€)
<b>303211</b>	235	<b>3,03</b>

**TWEEZERS FOR FISH-BONE REMOVAL**



Code	L mm	Price net (€)
<b>303220</b>	120	<b>1,95</b>

**ICE TONGS**



Code	L mm	Price net (€)
<b>471100</b>	145	<b>2,97</b>

**SUGAR/ICE TONGS**



Code	L mm	Price net (€)
<b>421070</b>	190	<b>4,90</b>

**SUGAR/ICE TONGS**



Code	L mm	Price net (€)
<b>421080</b>	110	<b>2,28</b>

## DECORATION KNIVES



- large selection of professional decoration knives
- ergonomic plastic handles



**1 VERTICAL DECORATIVE CHANNEL KNIFE**

Code	L mm	Price net (€)
<b>334102</b>	155	<b>6,69</b>

**2 CITRUS DECORATION KNIFE**

Code	L mm	Price net (€)
<b>334101</b>	132	<b>6,61</b>

**3 DECORATIVE BUTTER KNIFE**

Code	L mm	Price net (€)
<b>334106</b>	197	<b>5,28</b>

**5 HORIZONTAL DECORATIVE CHANNEL KNIFE**

Code	L mm	Price net (€)
<b>334103</b>	140	<b>6,11</b>

**6 TOMATO HOLLOWER**

Code	L mm	Price net (€)
<b>334111</b>	145	<b>7,28</b>

**4 CITRUS PEELING KNIFE**

Code	L mm	Price net (€)
<b>334113</b>	170	<b>6,94</b>

### KITCHEN TOOLS CARVING SET

- 7 elements
- set includes:
  - vegetable peeler
  - decorative butter knife
  - 2x decorative knife for balls: 15 mm and 22 mm
  - citrus decorative knife
  - vertical decorative channel knife
  - apple hollower



Code	Price net (€)
<b>334406</b>	<b>62,65</b>

### CURVED DECORATIVE KNIFE

- narrow blade



Code	L mm	Price net (€)
<b>334070</b>	70	<b>2,71</b>

**CAN OPENER**

- is fixed to the tabletop with cramp and screws
- knife with wheel included
- opens cans with a height of 20 to 400 mm

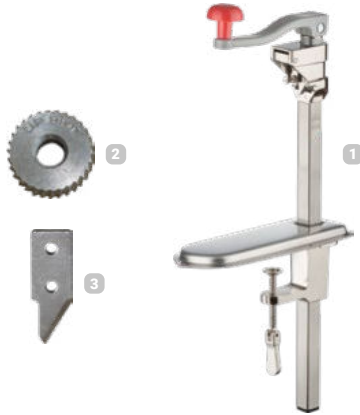

No.	Code	Product	Ø mm	H mm	Price net (€)
1.	<b>300640</b>	Can opener	-	640	<b>112,00</b>
2.	<b>300000</b>	Wheel	25	-	<b>12,90</b>
3.	<b>300010</b>	Blade	-	40	<b>6,38</b>

**CAN OPENER**



Code	H mm	Price net (€)
<b>300400</b>	560	<b>65,00</b>

**MANDOLINE SLICER**

- helps in slicing and fancy cutting
- smooth adjustment of cutting thickness
- choosing blade and cutting thickness without dismantling the knife
- ability to cut:
  - slices from 0.5 to 0.9 mm
  - julienne cuts 4.5 x 4.5 mm and 9x9 mm
- equipped with a pressure component
- safe non-slip device base
- has very sharp knives; please be careful
- we recommend shredding with the use of clamp during cutting and cleaning

Code	W mm	D mm	H mm	Price net (€)
<b>336003</b>	400	170	135	<b>51,80</b>



INOX

**APPLE PEELING AND CUTTING APPLIANCE**

- peeling, cutting and hollowing
- made of cast iron and nickel-plated steel
- base with suction cup for tabletop

Code	W mm	D mm	H mm	Price net (€)
<b>331010</b>	100	130	280	<b>23,20</b>



AI

## TABLETOP SCALES

- intended for work in the kitchen as auxiliary or control appliances
- LCD display
- multiple taring
- able to work without power supply
- overload protection



### AUXILIARY SCALE

- battery power supply (3 AA batteries included) or via the mains power supply (optional - power supply not included)
- working time on battery 300 hours
- measurement stabilization time approx. 2 seconds
- measuring range: g, lb, oz, ozt, dwt
- model 730011 used in the kitchen as a precision scale, portable dedicated to cafes (weighing coffee, etc.), confectioneries (e.g. brewing spices)
- integrated transport lock
- ABS case



Code	W mm	D mm	H mm	M kg	Scope kg	Precision g	Price net (€)
<b>730011</b>	140	205	41	0,4	0,62	0,1	<b>83,50</b>
<b>730012</b>	140	205	41	0,4	2,2	1	<b>65,60</b>

### RS232 PORT WITH CABLE FOR CONNECTING CASH REGISTER / COMPUTER / POS

- port communicates with scales 730032, 730062, 730152, 730302 with a cash register or POS (cash register program)

Code	L mm	Price net (€)
<b>730001</b>	1500	<b>44,00</b>



### AUXILIARY SCALE

- battery and mains power supply (230 V)
- working time on battery approx. 100 hours
- checkweighing feature
- measurement stabilization time approx. 3 seconds
- LCD display with backlight
- 4 adjustable feet, spirit level
- ABS case

Code	W mm	D mm	H mm	M kg	Scope kg	Precision g	Price net (€)
<b>730030</b>	260	270	122	3,2	3	0,5	<b>228,00</b>
<b>730060</b>	260	270	122	3,2	6	1	<b>243,00</b>
<b>730150</b>	260	270	122	3,2	15	2	<b>250,00</b>
<b>730301</b>	260	270	122	3,2	30	5	<b>243,00</b>



### Certified scale

Code	Product	W mm	D mm	H mm	M kg	Scope kg	Precision g	Price net (€)
<b>730032</b>	Scale	260	270	122	3,2	3	1	<b>357,50</b>
<b>730062</b>	Scale	260	270	122	3,2	6	2	<b>357,50</b>
<b>730152</b>	Scale	260	270	122	3,2	15	5	<b>357,50</b>
<b>730302</b>	Scale	260	270	122	3,2	30	10	<b>357,50</b>
<b>730002</b>	Weighing pan	300	225	-	-	-	-	<b>44,00</b>

**AUXILIARY SCALE**

- waterproof scales - IP68 - allowing safe weighing of liquids and work in humid environments
- battery and mains power supply (230 V)
- working time on battery approx. 50 hours
- checkweighing feature
- measurement stabilization time approx. 0.5 seconds
- 2 LCD displays with backlight
- 4 adjustable feet, backlit level
- stainless steel housing

Waterproof scale



Code	Product	W mm	D mm	H mm	M kg	Scope kg	Precision g	Price net (€)
<b>730031</b>	Scale	256	280	121	3,9	3	0,5	<b>463,00</b>
<b>730061</b>	Scale	256	280	121	3,9	6	1,0	<b>464,00</b>
<b>730151</b>	Scale	256	280	121	3,9	15	2,0	<b>449,00</b>
<b>730311</b>	Scale	256	280	121	3,9	30	5	<b>504,00</b>
<b>730003</b>	Weighing pan	300	225	-	-	-	-	<b>44,00</b>

**CALCULATOR SCALES**



- application in catering, trade, industry and pharmacies
- touch keyboard with replaceable pad (allows describing PLU codes)
- 4 adjustable feet, spirit level
- ABS case
- verified scales

**CALCULATOR SCALE**

- battery and mains power supply (230 V)
- working time on battery approx. 180 hours
- 2 LCD displays with backlight
- transport grip
- integrated power supply recess



Code	W mm	D mm	H mm	M kg	Scope kg	Precision g	Price net (€)
<b>731152</b>	351	359	111	4,2	15	5	<b>373,00</b>

## STORE SCALES



- application in catering, trade, industry and pharmacies
- 4 adjustable feet
- verified scales
- ABS case

### STORE SCALE

- mains or battery power supply with automatic shutdown
- LCD display
- proximity sensors for touchless scale taring
- features: percentage weighing, piece counting, totaling, result retention
- transport lock, measurement stabilization time approx. 1 second
- backlit level
- menu lock
- anti-theft protection
- optional interface handling modules: USB, RS232, Ethernet



Code	W mm	D mm	H mm	M kg	Scope kg	Precision g	U V	Price net (€)
<b>730036</b>	240	250	74	1,5	3,2	1	230	<b>332,00</b>
<b>730066</b>	240	250	74	1,5	6,4	2	230	<b>322,00</b>
<b>730156</b>	240	250	74	1,5	16,0	5	230	<b>322,00</b>

## WAREHOUSE SCALES

- suitable for work in warehouses, stores and wholesalers
- design resistant to shocks and vibrations
- overload protection
- 4 adjustable feet, spirit level
- verified scales



### WAREHOUSE SCALE

- checkweighing feature, subtotals, totals
- movable LCD display
- platform made of stainless steel

Code	W mm	D mm	H mm	Platform (WxD) mm	M kg	Scope kg	Precision g	U V	Price net (€)
<b>732032</b>	305	489	542	355 305	10,9	30	10	230	<b>636,00</b>
<b>732062</b>	420	686	896	550 420	17,5	60	20	230	<b>776,00</b>
<b>732152</b>	420	686	896	550 420	17,5	150	50	230	<b>873,00</b>
<b>732352</b>	500	785	896	650 500	27,6	300	100	230	<b>969,00</b>



**TEMPERATURE INDICATOR**

- temperature indicator - 40÷40°C
- stainless steel housing
- suspension bracket



Code	Price net (€)
620110	5,85

**THERMOMETER PROBE**

- temperature indicator -0÷300°C
- stainless steel housing 18/10



Code	Ø mm	L mm	Price net (€)
620510	50	160	6,29

**THERMOMETER**

- temperature -20÷50°C
- functional pendant

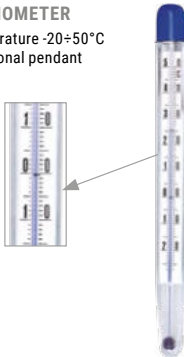

Code	Price net (€)
620210	5,74

**ELECTRONIC THERMOMETER**

- temperature -50÷280°C
- probe 210 mm
- probe cover
- sold without batteries (matching A76 or LR44 battery)



Code	Price net (€)
620010	27,60

**ELECTRONIC THERMOMETER WITH MOVABLE HEAD**

- temperature range -50÷300°C / -58÷572°F
- rotating stainless steel probe
- reading stop function
- sold without batteries (matching CR2032 battery)

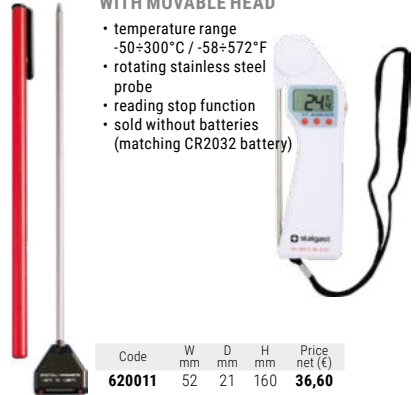

Code	W mm	D mm	H mm	Price net (€)
620011	52	21	160	36,60

**THERMO-HYGROMETER**

- temperature 0÷50°C
- humidity 25÷95%
- can be hung
- sold without batteries (matching AAA battery)



Code	Price net (€)
620310	31,80

**NON-CONTACT DIGITAL THERMOMETER**

- temperature -50÷380°C
- laser viewfinder
- digital display
- digital thermometer for contactless measurement of food temperature
- sold without batteries (matching 6LR61 battery)



Code	Price net (€)
620711	41,10



# KNIVES AND CUTTING BOARDS

Wide range of high-quality knives necessary in gastronomy. Professional cutting boards that are part of every kitchen equipment.

Knives and kitchen knife sets .....	91-105
Cleavers, mallets .....	94, 111
Magnetic strips .....	102
Sharpeners and steels .....	105-106

Kitchen scissors .....	110
Cutting boards .....	107-109
Butcher's block .....	110



## SANELLI KNIVES PREMANA PROFESSIONAL LINE

INOX



- non-slip handle made of two types of plastic, hard (red) and soft (green)
- chrome-molybdenum steel blade with a hardness of 54-56 HRC

blade shape refined with the utmost care

blade shaft deeply embedded in the handle



Patent/Brevet  
Italy N° 199524  
Europe N° 0176486  
USA N° 4712304

blade made of carbon-chromium-molybdenum alloy with added vanadium with the designation X60CrMoV14 and hardness of 54-56 HRC

handle lining made of durable Santoprene and polypropylene with added Biomaster antibacterial agent



## FOR VERSATILE USE IN CATERING AND WIDE APPLICATION IN FOOD INDUSTRIES

- manufactured by a global Italian brand, whose tradition dates back to 1864
- blades have a concave cut for better knife balance, comfort and efficiency of the users' work
- each knife is finished and sharpened manually
- the homogeneity of the cutting edge with the optimal angle (<math><35^\circ</math>) is controlled by means of laser equipment
- long-lasting sharpness of corrosion-resistant cutting edges with high hardness and carefully selected flexibility
- blades easily undergo the sharpening process
- ergonomic shape of handles developed at the Milan Polytechnic in the Ergonomics of Posture and Movement department using computer experimental tests
- unique handles made of Santoprene with added polypropylene for non-slip properties



Santoprene handles are made using a durable Biomaster antibacterial material; the added silver ions, which are an integral part of the material, inhibit microbial growth throughout the life of the knives, eliminating 99.71% of the most virulent bacteria: methicillin-resistant staphylococcus aureus (MRSA) and colibacillosis (Lat. Escherichia coli)





No.	Code	Product	L mm*	Price net (€)
1.	<b>218200</b>	Kitchen knife	200	<b>43,80</b>
	<b>218250</b>	Kitchen knife	255	<b>59,50</b>
	<b>218300</b>	Kitchen knife	300	<b>72,80</b>
2.	<b>202200</b>	Shredding knife	210	<b>62,30</b>
	<b>202240</b>	Shredding knife	255	<b>71,00</b>
3.	<b>219240</b>	Bread knife	235	<b>40,70</b>
	<b>219320</b>	Bread knife	315	<b>51,80</b>
4.	<b>220320</b>	Smoked meat knife	315	<b>53,00</b>
5.	<b>210240</b>	Roasting knife	230	<b>39,50</b>

No.	Code	Product	L mm*	Price net (€)
6.	<b>204220</b>	Flexible filleting knife	220	<b>40,10</b>
7.	<b>201180</b>	Butcher's knife	180	<b>52,60</b>
	<b>201220</b>	Butcher's knife	230	<b>53,00</b>
8.	<b>207160</b>	Straight boning knife	155	<b>38,80</b>
9.	<b>203180</b>	Notching knife	180	<b>42,30</b>
10.	<b>208160</b>	Curved boning knife	160	<b>38,40</b>
11.	<b>209160</b>	Narrow boning knife	160	<b>37,90</b>
12.	<b>205280</b>	Salmon knife	275	<b>41,90</b>
13.	<b>225330</b>	Fish knife	330	<b>74,40</b>



The full range of knife kits on p. 115-117

## SET OF KNIVES

- the set includes rolled knives: 218250, 219240, 207160, 214100, 216060 and a 460x160 mm (WxD) buckle case

No.	Code	Product	L mm*	Price net (€)
1.	<b>215120</b>	Tomato knife	115	<b>19,60</b>
2.	<b>214100</b>	Peeling knife	100	<b>17,20</b>
3.	<b>216060</b>	Vegetable knife	60	<b>16,60</b>
4.	<b>226180</b>	Japanese knife	180	<b>54,80</b>
5.	<b>226161</b>	Japanese santoku knife	160	<b>38,00</b>
6.	<b>270260</b>	Spatula	260	<b>74,40</b>
7.	<b>270150</b>	Spatula	150	<b>59,10</b>
8.	<b>264170</b>	Perforated spatula	170	<b>50,00</b>
9.	<b>213160</b>	Cleaver	160	<b>88,10</b>
10.	<b>212220</b>	Steel	220	<b>56,80</b>
	<b>212300</b>	Steel	300	<b>75,60</b>
11.	<b>231360</b>	Cheese knife with two handles	360	<b>144,00</b>
12.	<b>200005</b>	Sanelli knives set	-	<b>167,00</b>





## SANELLI KNIVES



- the Skin knives line is made of steel with high 54-56 HRC hardness and good flexibility
- high quality of cut
- non-slip handle made of polypropylene



The full range of knife kits on p. 115-117

No.	Code	Product	L mm*	Price net (€)
1.	<b>286212</b>	Kitchen knife	210	<b>36,90</b>
	<b>286252</b>	Kitchen knife	255	<b>43,00</b>
2.	<b>286182</b>	Utility knife	180	<b>28,90</b>
	<b>286222</b>	Utility knife	230	<b>35,00</b>
3.	<b>286243</b>	Roasting knife	230	<b>25,50</b>
4.	<b>286242</b>	Bread knife	235	<b>25,10</b>
5.	<b>286102</b>	Peeling knife	95	<b>10,80</b>
	<b>287110</b>	Peeling knife	110	<b>7,17</b>

No.	Code	Product	L mm*	Price net (€)
6.	<b>287111</b>	Peeling knife	110	<b>7,17</b>
7.	<b>287112</b>	Tomato knife	120	<b>8,55</b>
8.	<b>287120</b>	Universal knife	120	<b>7,91</b>
9.	<b>286062</b>	Vegetable knife	60	<b>10,80</b>
	<b>287070</b>	Vegetable knife	70	<b>7,06</b>

## STALGAST ELITE FORGED KNIVES



- perfectly designed from the blade, edge, spine, from base to stem
- ergonomic and hygienic design preventing the accumulation of leftover at the joints
- perfectly made and perfectly balanced
- hot-forged from a single steel rod, subjected to a process consisting of 50 stages

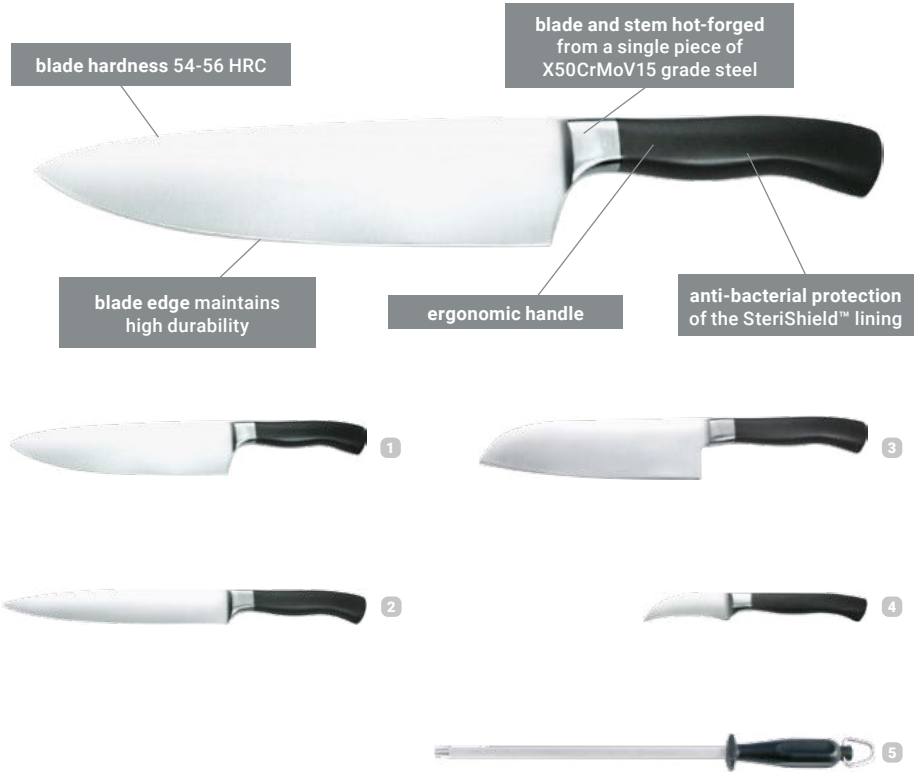

The full range of knife kits on p 115-117

No.	Code	Product	L mm*	Price net (€)
1.	<b>290250</b>	Kitchen knife	250	<b>50,70</b>
2.	<b>291230</b>	Kitchen knife	230	<b>40,60</b>
3.	<b>293065</b>	Vegetable knife	65	<b>19,80</b>

No.	Code	Product	L mm*	Price net (€)
4.	<b>295180</b>	Santoku knife	180	<b>50,70</b>
5.	<b>212257</b>	Diamond steel	255	<b>17,00</b>

# STALGAST KNIFE MADE OF FORGED STEEL



- blade hardness 52-54 HRC
- made of forged steel
- handle adjusted in a way that prevents the accumulation of leftovers at the joints

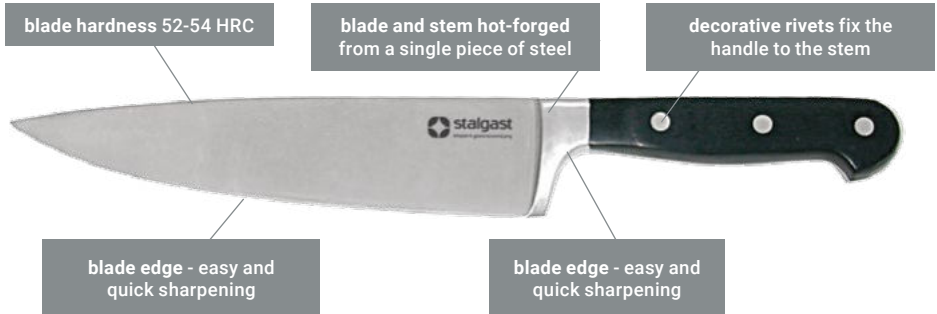

The full range of knife kits on p. 115-117

No.	Code	Product	L mm*	Price net (€)
1.	<b>218209</b>	Kitchen knife	200	<b>12,70</b>
	<b>218259</b>	Kitchen knife	255	<b>13,80</b>
	<b>218309</b>	Kitchen knife	300	<b>15,00</b>
2.	<b>219209</b>	Bread knife	200	<b>10,50</b>
3.	<b>203139</b>	Meat knife	130	<b>7,85</b>
	<b>203209</b>	Meat knife	200	<b>10,40</b>
4.	<b>209159</b>	Filleting knife	155	<b>8,01</b>
	<b>204189</b>	Filleting knife	180	<b>8,29</b>

No.	Code	Product	L mm*	Price net (€)
5.	<b>217139</b>	Steak/tomato knife	115	<b>6,94</b>
6.	<b>214109</b>	Peeling knife	100	<b>5,92</b>
7.	<b>216089</b>	Vegetable knife	80	<b>6,28</b>
8.	<b>211189</b>	Fork	180	<b>11,20</b>
9.	<b>212259</b>	Steel	250	<b>6,33</b>

## STALGAST KNIVES OF ROLLED STEEL



- blade hardness 52-54 HRC
- handle adjusted in a way that prevents the accumulation of leftovers at the joints
- blades made of stainless steel hardened by rolling

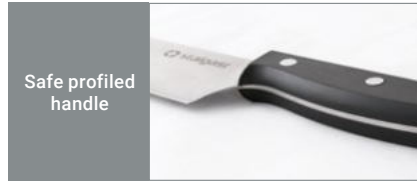

The full range of knife kits on p 115-117

No.	Code	Product	L mm*	Price net (€)
1.	<b>218208</b>	Kitchen knife	210	<b>6,63</b>
	<b>218258</b>	Kitchen knife	240	<b>8,48</b>
2.	<b>210208</b>	Roasting knife	200	<b>4,94</b>
3.	<b>219208</b>	Bread knife	195	<b>5,16</b>
4.	<b>214108</b>	Peeling knife	100	<b>3,52</b>
	<b>214138</b>	Peeling knife	115	<b>3,94</b>

No.	Code	Product	L mm*	Price net (€)
5.	<b>216088</b>	Vegetable knife	75	<b>3,74</b>
6.	<b>211158</b>	Fork	150	<b>3,39</b>
7.	<b>227259</b>	Poultry shears	250	<b>10,20</b>
8.	<b>212259</b>	Steel	250	<b>6,33</b>
	<b>212309</b>	Steel	300	<b>8,35</b>

## JAPANESE KNIFE SASHIMI

- perfectly designed from the blade, edge, spine, from base to stem
- the production process includes 50 stages
- hot forged from one piece of steel
- they have a hardness of 54-56 HRC
- made of high quality alloy of German surgical steel with a martensitic structure
- the blade's cutting edge is sharpened on one side in accordance with Japanese tradition



Code	L mm*	Price net (€)
298210	210	32,06



## PREMIUM HACCP STAINLESS STEEL KNIVES



- made of high quality X50CrMoV15 steel;
- non-slip handle
- ergonomic and hygienic handle design preventing the accumulation of leftovers at the joints

## 1 KITCHEN KNIFE

Code	Colour	L mm*	Price net (€)
283262	●	260	21,43
283263	●	260	21,43
283264	●	260	21,43
283265	●	260	21,43
283266	○	260	21,43



## 3 KITCHEN KNIFE

Code	Colour	L mm*	Price net (€)
283201	●	200	16,50
283202	●	200	14,85
283203	●	200	16,50



## 4 UTILITY KNIFE

Code	Colour	L mm*	Price net (€)
284181	●	180	14,59
284183	●	180	14,59
284184	●	180	14,58



## 5 CUTTING KNIFE

Code	Colour	L mm*	Price net (€)
283181	●	180	16,10
283186	○	180	14,50



## 6 UTILITY KNIFE

Code	Colour	L mm*	Price net (€)
284151	●	150	13,16



## 8 VEGETABLE KNIFE

Code	Colour	L mm*	Price net (€)
283062	●	60	4,61



## 9 BREAD KNIFE

Code	Colour	L mm*	Price net (€)
283306	○	300	15,30



## 10 BONING KNIFE

Code	Colour	L mm*	Price net (€)
283304	●	300	15,11



## 11 BUTCHER'S KNIFE

Code	Colour	L mm*	Price net (€)
284251	●	250	15,92



## 12 BUTCHER'S KNIFE

• curved

Code	Colour	L mm*	Price net (€)
284311	●	250	15,11



## 13 SOFT CHEESE KNIFE

Code	Colour	L mm*	Price net (€)
283156	○	150	7,77





# STALGAST HACCP KNIVES OF ROLLED STEEL



HACCP  
marking  
system



RAW  
MEAT



VEGETA-  
BLES



RAW  
POULTRY



FISH



DAIRY



COOKED MEAT  
SMOKED MEAT

## 1 UTILITY KNIFE

Code	Colour	L mm*	Price net (€)
281152	●	160	4,32
281153	●	160	4,32
281154	●	160	4,53



## 2 KITCHEN KNIFE

Code	Colour	L mm*	Price net (€)
281211	●	220	4,91
281212	●	220	4,91
281213	●	220	4,91
281214	●	220	4,91
281216	●	220	4,91



## 3 KITCHEN KNIFE

Code	Colour	L mm*	Price net (€)
281251	●	250	5,74
281252	●	250	5,74
281253	●	250	5,74
281254	●	250	5,74
281255	○	250	5,74
281256	●	250	5,74



## 4 CUTTING KNIFE

Code	Colour	L mm*	Price net (€)
282151	●	160	4,56
282154	●	160	4,43



## 5 PEELING KNIFE

Code	Colour	L mm*	Price net (€)
285081	●	90	1,44
285082	●	90	1,63
285083	●	90	1,45



## 6 PEELING KNIFE

Code	Colour	L mm*	Price net (€)
285092	●	100	2,15



## 7 PEELING KNIFE

Code	Colour	L mm*	Price net (€)
285102	●	105	1,97



## 8 BREAD ROLL KNIFE

Code	Colour	L mm*	Price net (€)
250012	●	85	2,28





## CHEF'S CASE FOR KNIVES

- 10 knife compartments
- fitted with a belt with a length adjustment of 810-1370 mm
- compartment for pens, business cards and other accessories
- max knife length 450 mm
- cover closed with plastic latches
- ID on the back with a slide-out name plate for personal data



Code	W mm	D mm	H mm	Price net (€)
201000	515	230	80	36,36

### MAGNET STRIP WITH JOOKS

PP

No.	Code	Ilość haczyków	L mm	Price net (€)
1.	248458	5	450	12,40
2.	248608	6	625	16,50



### MAGNET STRIP

- modern design
- recommended for „open” kitchens

INOX

Code	L mm	Price net (€)
249448	406	24,80



### MAGNET STRIP

Code	L mm	Price net (€)
249338	330	4,62
249558	550	7,15



## KNIVES KITS

### SANNELII SET WITH STRIP

- non-slip handle made of durable Santoprene and polypropylene with added Biomaster antibacterial agent
- chrome-molybdenum steel blade
- blade hardness 54-56 HRC



No.	Code	Product	L mm*	Price net (€)
1.	<b>249558</b>	Magnet strip	550	<b>7,15</b>
2.	<b>218200</b>	Kitchen knife	200	<b>43,80</b>
3.	<b>264170</b>	Turner	170	<b>50,00</b>
4.	<b>204220</b>	Flexible filleting knife	220	<b>40,10</b>
5.	<b>201220</b>	Butcher's knife	230	<b>53,00</b>
6.	<b>209160</b>	Boning knife	160	<b>37,90</b>
7.	<b>214100</b>	Peeling knife	100	<b>17,20</b>



### SET OF FORGED KNIVES WITH A COVER

- 10 knife compartments
- ergonomic handle made in a way that eliminates accumulating leftovers at the joints
- blade made from a forged rod of X50CrMoV15 grade steel

No.	Code	Product	L mm*	Price net (€)
1.	<b>212257</b>	Diamond steel	255	<b>17,00</b>
2.	<b>295180</b>	Santoku knife	180	<b>50,70</b>
3.	<b>291230</b>	Kitchen knife	230	<b>40,60</b>
4.	<b>293065</b>	Vegetable knife	65	<b>19,80</b>
5.	<b>201000</b>	Case	-	<b>36,36</b>



## ROLLED KNIVES SET WITH A STRIP

- handle adjusted in a way that prevents the accumulation of leftovers at the joints
- blade made of stainless steel hardened by rolling
- blade hardness 52-54 HRC



No.	Code	Product	L mm*	Price net (€)
1.	<b>249338</b>	Magnet strip	330	<b>4,62</b>
2.	<b>212309</b>	Steel	300	<b>8,35</b>
3.	<b>218208</b>	Kitchen knife	210	<b>6,63</b>
4.	<b>210208</b>	Roasting knife	200	<b>4,94</b>
5.	<b>211158</b>	Fork	150	<b>3,39</b>
6.	<b>214108</b>	Peeling knife	100	<b>3,52</b>

## SET OF FORGED KNIVES WITH A COVER

- handle adjusted in a way that prevents the accumulation of leftovers at the joints
- made of forged steel
- blade hardness 52-54HRC



## STALGAST KNIFE CASE

- made of waterproof material
- velcro fastening system
- 6 knife compartments
- WxD dimension: 125x410 mm (615x350 mm if unfolded)



No.	Code	Product	L mm*	Price net (€)
1.	<b>212259</b>	Steel	250	<b>6,33</b>
2.	<b>211189</b>	Fork	180	<b>11,20</b>
3.	<b>218209</b>	Kitchen knife	200	<b>12,70</b>
4.	<b>219209</b>	Bread knife	200	<b>10,50</b>
5.	<b>203209</b>	Meat knife	200	<b>10,40</b>
6.	<b>209159</b>	Filleting knife	155	<b>8,01</b>
7.	<b>200019</b>	Case	-	<b>27,81</b>

## KNIVES SET

- the set includes rolled knives: 218250, 219240, 207160, 214100, 216060 and a buckle case (WxD): 460x160 mm



Code	Price net (€)
200005	167,00

## STEELS



No.	Code	Product	L mm*	Price net (€)
1.	212220	Sanelli steel	220	56,80
	212300	Sanelli steel	300	75,60
2.	212259	Steel	250	6,33
	212309	Steel	300	8,35
3.	212257	Diamond steel	255	17,00

## KNIFE SHARPENER

- ergonomic handle
- also sharpens serrated knives
- sharpening section made of tungsten carbide



Code	W mm	D mm	H mm	Price net (€)
247500	145	20	60	18,20

## KNIFE SHARPENER

- two sharpening parts, one made of calcium carbide, the other ceramic



Code	W mm	D mm	H mm	Price net (€)
247501	190	50	60	15,75

## KNIFE SHARPENER

- intended for sharpening knives with a smooth blade
- case made of ABS durable plastic
- the 360° sharpening section keeps the blade in a fixed position, eliminating vibrations
- the precision of sharpening wheels is - 0.01 mm
- fitted with a non-slip suction cup, allowing fixing to the tabletop



Code	W mm	D mm	H mm	Price net (€)
247502	145	63	52	21,90



## SHARPENING DEVICE

- designed for sharpening knives and scissors
- for sharpening smooth knives
- the sharpening process involves no water
- 2 guides for sharpening the right or left side of the knife

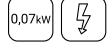

Code	W mm	D mm	H mm	N rev/min	P kW	V V	Price net (€)
<b>242180</b>	190	90	80	1950	0,07	230	<b>136,00</b>

## SHARPENING DEVICE

- suitable for sharpening carbon steel knives and scissors
- the sharpening process takes place without water
- does not damage or overheat the steel blade
- case made of durable plastic
- two sharpening parts for knives with slim and big blade
- sharpening angle 14°-28°
- possibility of sharpening carbon steel knives
- has an easily replaceable abrasive lining
- drawer for filings



Code	W mm	D mm	H mm	N rev/min	P kW	U V	Price net (€)
<b>242500</b>	320	110	130	3000	0,11	230	<b>263,77</b>



## KNIFE SHARPENING DEVICE

- max sharpening angle 28°
- the sharpening process takes place without water
- diamond sharpening stone
- does not damage or overheat the steel blade
- suitable for sharpening ceramic knives
- filings container



Code	W mm	D mm	H mm	N rev/min	P kW	V V	Price net (€)
<b>242001</b>	226	98	100	6600	0,09	230	<b>190,00</b>



## HACCP CUTTING BOARDS

- made of polypropylene
- available in 6 colors



HACCP marking system



RAW MEAT



VEGETABLES



RAW POULTRY



FISH



DAIRY



COOKED MEAT  
SMOKED MEAT

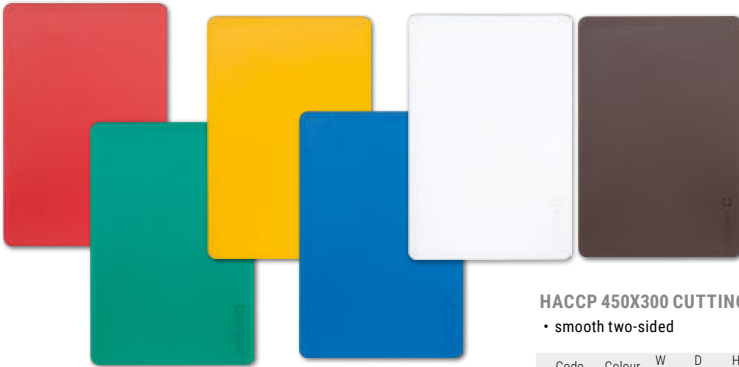

### HACCP BOARD SET

- set of boards made of polypropylene in 6 colors



Code	Description	Price net (€)
341450	450x300 smooth	65,00
341320	GN 1/2 with cut-out	55,00
341530	GN 1/1 with cut-out	130,00

### HACCP 450X300 CUTTING BOARD

- smooth two-sided

Code	Colour	W mm	D mm	H mm	Price net (€)
341451	●	450	300	13	11,50
341452	●	450	300	13	11,50
341453	●	450	300	13	11,50
341454	●	450	300	13	11,50
341455	○	450	300	13	11,50
341456	●	450	300	13	11,50

### BOARD STAND

- rack for 6 boards

INOX



Code	W mm	D mm	H mm	Price net (€)
349060	300	270	270	20,90

## BOARDS WITH CUT-OUT

### HACCP CUTTING BOARD GN 1/2

- two-sided:
- smooth
- with cut-out

Code	Colour	W mm	D mm	H mm	Price net (€)
341321	●	325	265	12	9,90
341322	●	325	265	12	9,90
341323	●	325	265	12	9,90
341324	●	325	265	12	9,90
341325	○	325	265	12	9,90
341326	●	325	265	12	9,90



### HACCP CUTTING BOARD GN 1/1

- two-sided:
- smooth
- with cut-out

Code	Colour	W mm	D mm	H mm	Price net (€)
341531	●	530	325	15	23,30
341532	●	530	325	15	23,30
341533	●	530	325	15	23,30
341534	●	530	325	15	23,30
341535	○	530	325	15	23,30
341536	●	530	325	15	23,30



### HACCP600X400 CUTTING BOARD

- two-sided:
- smooth
- with cut-out

Code	Colour	W mm	D mm	H mm	Price net (€)
341631	●	600	400	18	30,13
341632	●	600	400	18	30,13
341633	●	600	400	18	30,13
341634	●	600	400	18	30,13
341635	○	600	400	18	30,13
341636	●	600	400	18	30,13



## CUTTING BOARD

- made of polypropylene in black
- available in two-sided smooth or notched variant
- for use in smoking, grilling, BBQ, making sushi, banquet service and open kitchens



No.	Code	Description	W mm	D mm	H mm	Price net (€)
1.	<b>341457</b>	Smooth board	450	300	13	<b>11,50</b>
2.	<b>341327</b>	Board with a cut-out GN 1/2	325	265	12	<b>9,90</b>
	<b>341537</b>	Board with a cut-out GN 1/1	530	325	15	<b>23,30</b>
	<b>341637</b>	Board with a cut-out	600	400	18	<b>30,13</b>

Board with a cut-out



1



2



Two-sided smooth board



## CUTTING BOARD

- recommended for use in kitchen facilities and bars
- non-slip coating on the board edges
- perfect solution for smooth tabletops
- equipped with a practical hanger
- temp. resistance up to +90°C



Code	W mm	D mm	H mm	Price net (€)
<b>340270</b>	270	190	9	<b>6,92</b>
<b>340351</b>	350	250	10	<b>13,40</b>



## CUTTING BOARD

- made of beech wood
- thickness 20 mm



No.	Code	W mm	D mm	H mm	Price net (€)
1.	<b>342250</b>	300	250	20	<b>14,90</b>
2.	<b>342400</b>	400	300	20	<b>18,00</b>
3.	<b>342500</b>	500	300	20	<b>22,30</b>

## BUTCHER'S BLOCK

- block plate made of polyethylene
- block plate dimensions (WxDxH): 500x400x50 mm
- stainless steel base

PE



Code	W mm	D mm	H mm	Price net (€)
<b>680541</b>	500	400	860	<b>295,00</b>

## SCISSORS



No.	Code	Product	L mm	Price net (€)
1.	<b>227180</b>	Kitchen scissors	185	<b>8,38</b>
2.	<b>227250</b>	Poultry shears	250	<b>59,80</b>
3.	<b>227259</b>	Poultry shears	250	<b>10,20</b>

## PEELERS



No.	Code	Product	Blade length mm	L mm	Price net (€)
1.	<b>334118</b>	Peeler smooth blade	55	125	<b>7,06</b>
	<b>334119</b>	Peeler corrugated blade	55	125	<b>5,28</b>
2.	<b>334100</b>	Vegetable peeler	50	100	<b>5,00</b>

## MEAT Mallet

- plastic handle
- 3 crushing surfaces

INOX



Code	M kg	Price net (€)
247090	0,9	31,20

## MEAT TENDERIZER

- blades in two rows made of high quality stainless steel
- meat fibers are being cut, not crushed
- possibility to remove the foot for cleaning

INOX



Code	Colour	Blades	W mm	D mm	H mm	Price net (€)
247514	●	45	145	45	103	23,65

## MEAT Mallet

- 2 crushing surfaces



Code	M kg	L mm	Price net (€)
247040	0,4	250	9,46

## CHEF'S Mallet

- spring system connected to 56 knives cutting through meat fibers
- handle length 185 mm

INOX



Code	Blades	W mm	D mm	H mm	Price net (€)
247519	56	265	60	70	48,10





## ACCESSORIES AND TABLEWARE

Classic tableware recommended for professional catering. Modern glass lines and cutlery designed for frequent use, recommended for restaurants, bars, pubs, cafes, catering and others.

Cutlery.....	113-129	Spice grinders.....	138
Steak and pizza cutlery.....	128	Mortar with pestle.....	138
Porcelain and tableware.....	130-135	Bread baskets.....	139-140
Spice kits.....	136	Menu holder, table bin, stew kettles.....	138



## CATERING CUTLERY

• price per item

INOX  
18/0



No.	Code	Product	L mm	K pes	Price net (€)
1.	<b>354160</b>	Table spoon	178	12	<b>0,42</b>
2.	<b>354150</b>	Table fork	197	12	<b>0,42</b>
3.	<b>354180</b>	Table knife	208	12	<b>0,60</b>
4.	<b>354110</b>	Tea spoon	138	12	<b>0,23</b>



## BAR CUTLERY

• price per item

INOX  
18/0



No.	Code	Product	L mm	K pcs	Price net (€)
1.	<b>354060</b>	Table spoon	175	12	<b>0,47</b>
2.	<b>354050</b>	Table fork	180	12	<b>0,47</b>
3.	<b>354080</b>	Table knife	210	12	<b>0,86</b>
4.	<b>354010</b>	Tea spoon	135	12	<b>0,40</b>



**BISTRO CUTLERY**

• price per item

INOX  
18/0

No.	Code	Product	L mm	K pcs	Price net (€)
1.	<b>355061</b>	Table spoon	176	12	<b>0,40</b>
2.	<b>355051</b>	Table fork	176	12	<b>0,40</b>
3.	<b>355081</b>	Table knife	205	12	<b>0,97</b>
4.	<b>355011</b>	Tea spoon	132	12	<b>0,32</b>



# CANTEEN CUTLERY

• price per item

INOX  
18/0



No.	Code	Product	L mm	K pcs	Price net (€)
1.	<b>353060</b>	Table spoon	195	12	<b>0,43</b>
2.	<b>353051</b>	Table fork	190	12	<b>0,44</b>
3.	<b>353081</b>	Table knife	210	12	<b>0,86</b>
4.	<b>353010</b>	Tea spoon	135	12	<b>0,32</b>



# ECO RESTAURANT CUTLERY

• price per item

INOX  
18/0



No.	Code	Product	L mm	K pcs	Price net (€)
1.	<b>351061</b>	Table spoon	187	12	<b>0,77</b>
2.	<b>351051</b>	Table fork	190	12	<b>0,77</b>
3.	<b>351081</b>	Table knife	205	12	<b>0,81</b>
4.	<b>351011</b>	Tea spoon	135	12	<b>0,52</b>



# CLASSIC CUTLERY

• price per item

INOX  
18/0



No.	Code	Product	L mm	K pcs	Price net (€)
1.	<b>357060</b>	Table spoon	190	12	<b>0,87</b>
2.	<b>357050</b>	Table fork	195	12	<b>0,87</b>
3.	<b>357080</b>	Table knife	230	12	<b>1,08</b>
4.	<b>357010</b>	Tea spoon	140	12	<b>0,67</b>
5.	<b>357120</b>	Cake fork	140	12	<b>0,67</b>
6.	<b>357140</b>	Coffee spoon	100	12	<b>0,67</b>





# ARDILA CUTLERY

• price per item

INOX  
18/0



No.	Code	Product	L mm	K pcs	Price net (€)
1.	<b>357460</b>	Table spoon	197	12	<b>0,79</b>
2.	<b>357450</b>	Table fork	201	12	<b>0,79</b>
3.	<b>357480</b>	Table knife	225	12	<b>1,19</b>
4.	<b>357410</b>	Tea spoon	133	12	<b>0,42</b>



# NAVIA CUTLERY

• price per item

INOX  
18/0



No.	Code	Product	L mm	K pcs	Price net (€)
1.	<b>350260</b>	Table spoon	189	12	<b>0,83</b>
2.	<b>350250</b>	Table fork	201	12	<b>0,86</b>
3.	<b>350280</b>	Table knife	240	12	<b>1,65</b>
4.	<b>350210</b>	Tea spoon	139	12	<b>0,55</b>
5.	<b>350270</b>	Soup ladle	305	1	<b>2,40</b>

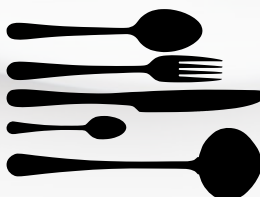

# SEGURA CUTLERY

• price per item

INOX  
18/0



No.	Code	Product	L mm	K pcs	Price net (€)
1.	<b>355760</b>	Table spoon	185	12	<b>0,97</b>
2.	<b>355750</b>	Table fork	193	12	<b>0,97</b>
3.	<b>355780</b>	Table knife	230	12	<b>2,26</b>
4.	<b>355710</b>	Tea spoon	133	12	<b>0,69</b>
5.	<b>355740</b>	Coffee spoon	115	12	<b>0,65</b>
6.	<b>355720</b>	Cake fork	136	12	<b>0,69</b>



# TAMBRE CUTLERY

• price per item

INOX  
18/0



No.	Code	Product	L mm	K pcs	Price net (€)
1.	<b>355660</b>	Table spoon	200	12	<b>1,04</b>
2.	<b>355650</b>	Table fork	200	12	<b>0,95</b>
3.	<b>355680</b>	Table knife	218	12	<b>1,78</b>
4.	<b>355610</b>	Tea spoon	147	12	<b>0,92</b>
5.	<b>355640</b>	Cake spatula	220	1	<b>1,04</b>
6.	<b>355670</b>	Soup ladle	305	1	<b>2,58</b>

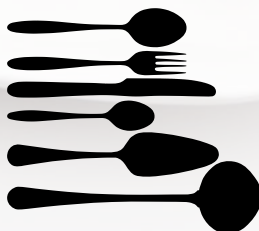

## RESTAURANT CUTLERY

- price per item
- 351080 knife made of AISI 420 steel

INOX  
18/10

No.	Code	Product	L mm	K pcs	Price net (€)
1.	<b>351060</b>	Table spoon	195	12	<b>2,39</b>
2.	<b>351050</b>	Table fork	192	12	<b>2,39</b>
3.	<b>351080</b>	Table knife	210	12	<b>3,21</b>
4.	<b>351010</b>	Tea spoon	137	12	<b>1,37</b>
5.	<b>351140</b>	Coffee spoon	114	12	<b>1,37</b>
6.	<b>351120</b>	Cake fork	145	12	<b>1,37</b>



# TURIA CUTLERY

• price per item

INOX  
18/0



No.	Code	Product	L mm	K pcs	Price net (€)
1.	<b>350560</b>	Table spoon	198	12	<b>1,45</b>
2.	<b>350550</b>	Table fork	218	12	<b>1,45</b>
3.	<b>350580</b>	Table knife	229	12	<b>1,68</b>
4.	<b>350510</b>	Tea spoon	140	12	<b>1,09</b>





## KANADI CUTLERY

• price per item

INOX  
18/10

No.	Code	Product	L mm	K pcs	Price net (€)
1.	<b>359860</b>	Table spoon	200	12	<b>2,93</b>
2.	<b>359850</b>	Table fork	195	12	<b>2,93</b>
3.	<b>359880</b>	Table knife	210	12	<b>3,91</b>
4.	<b>359810</b>	Tea spoon	110	12	<b>1,05</b>
5.	<b>359840</b>	Dessert spoon	153	12	<b>1,95</b>
6.	<b>359820</b>	Cake fork	156	12	<b>1,95</b>



## AKENDIZ CUTLERY

• price per item

INOX  
18/10

No.	Code	Product	L mm	K pcs	Price net (€)
1.	<b>359960</b>	Table spoon	200	12	<b>2,93</b>
2.	<b>359950</b>	Table fork	198	12	<b>2,93</b>
3.	<b>359980</b>	Table knife	207	12	<b>3,91</b>
4.	<b>359910</b>	Tea spoon	109	12	<b>1,05</b>
5.	<b>359940</b>	Dessert spoon	154	12	<b>1,95</b>
6.	<b>359920</b>	Cake fork	157	12	<b>1,95</b>



## BAGUETTE CUTLERY

INOX  
18/10

- price per item

No.	Code	Product	L mm	K pcs	Price net (€)
1.	<b>353360</b>	Table spoon	193	12	<b>2,57</b>
2.	<b>353350</b>	Table fork	190	12	<b>2,57</b>
3.	<b>353380</b>	Table knife	225	12	<b>3,80</b>
4.	<b>353310</b>	Tea spoon	140	12	<b>1,42</b>
5.	<b>353340</b>	Coffee spoon	120	12	<b>1,27</b>
6.	<b>353320</b>	Cake fork	143	12	<b>1,42</b>



## HIDRAULIC CUTLERY

INOX  
18/0

- we recommend placing the product in the cutlery basket when washing in the dishwasher
- price per item



No.	Code	Product	L mm	K pcs	Price net (€)
1.	<b>353260</b>	Table spoon	200	12	<b>2,77</b>
2.	<b>353250</b>	Table fork	200	12	<b>2,77</b>
3.	<b>353280</b>	Table knife	220	12	<b>4,33</b>
4.	<b>353210</b>	Tea spoon	140	12	<b>1,61</b>
5.	<b>353261</b>	Table spoon	200	12	<b>4,38</b>
6.	<b>353251</b>	Table fork	200	12	<b>4,38</b>
7.	<b>353281</b>	Table knife	220	12	<b>6,42</b>
8.	<b>353211</b>	Tea spoon	140	12	<b>2,87</b>



## BCN COLOUR CUTLERY

INOX  
18/0

- we recommend placing the product in the cutlery basket when washing in the dishwasher
- price per item

No.	Code	Product	L mm	K pcs	Price net (€)
1.	<b>353160</b>	Table spoon	200	12	<b>5,50</b>
2.	<b>353150</b>	Table fork	200	12	<b>5,50</b>
3.	<b>353180</b>	Table knife	221	12	<b>6,52</b>
4.	<b>353110</b>	Tea spoon	140	12	<b>4,09</b>
5.	<b>353190</b>	Latte spoon	202	12	<b>4,76</b>
6.	<b>353120</b>	Cake fork	140	12	<b>4,09</b>



No.	Code	Product	L mm	K pcs	Price net (€)
1.	<b>353161</b>	Table spoon	200	12	<b>5,50</b>
2.	<b>353151</b>	Table fork	200	12	<b>5,50</b>
3.	<b>353181</b>	Table knife	221	12	<b>6,52</b>
4.	<b>353111</b>	Tea spoon	140	12	<b>4,09</b>
5.	<b>353191</b>	Latte spoon	202	12	<b>4,76</b>
6.	<b>353121</b>	Cake fork	140	12	<b>4,09</b>



## BCN COLOUR CUTLERY

- we recommend placing the product in the cutlery basket when washing in the dishwasher
- price per item

No.	Code	Product	L mm	K pcs	Price net (€)
1.	<b>353162</b>	Table spoon	200	12	<b>5,50</b>
2.	<b>353152</b>	Table fork	200	12	<b>5,50</b>
3.	<b>353182</b>	Table knife	221	12	<b>6,52</b>
4.	<b>353112</b>	Tea spoon	140	12	<b>4,09</b>
5.	<b>353192</b>	Latte spoon	202	12	<b>4,76</b>
6.	<b>353122</b>	Cake fork	140	12	<b>4,09</b>



## STEAK AND PIZZA CUTLERY



### STEAK AND PIZZA KNIFE

- knives with handle made out of durable plastic
- blade made of high-quality stainless steel

Code	Colour	L mm	K pcs.	Price net (€)
<b>298115</b>	●	115	1	<b>9,69</b>



### STEAK AND PIZZA CUTLERY

- made of AISI 430 steel
- handgrip made of plastic

Code	L mm	K pcs.	Price net (€)
<b>298101</b>	95	1	<b>3,48</b>



# CUTLERY FOR CHILDREN

INOX  
18/0

- designed specifically for children
- recommended for allergy sufferers and those allergic to nickel
- sizes suitable for small children
- price per item



## PRE-SCHOOL CUTLERY

- 358180 knife made without cutting edge
- rounded teeth in a fork

No.	Code	Product	L mm	K pcs.	Price net (€)
1.	<b>358160</b>	Table spoon	153	12	<b>1,05</b>
2.	<b>358150</b>	Table pastry fork	152	12	<b>0,98</b>
3.	<b>358180</b>	Table knife	171	12	<b>1,49</b>
4.	<b>358110</b>	Dessert spoon	135	12	<b>0,91</b>



## KIDS CUTLERY

- handle pattern that encourages children to use

No.	Code	Product	L mm	K pcs.	Price net (€)
1.	<b>358061</b>	Table spoon	168	12	<b>0,87</b>
2.	<b>358051</b>	Table pastry fork	172	12	<b>0,91</b>
3.	<b>358081</b>	Table knife	182	12	<b>1,46</b>
4.	<b>358011</b>	Dessert spoon	133	12	<b>0,70</b>

## BLACK AND COLORED PORCELAIN

- black porcelain, smooth and decorated
- color porcelain available in two colors
- durable enamel coating
- dimensions and total capacities are approximate
- sold separately





## Black porcelain

## 1 FLAT PLATE

• smooth

Code	Ø mm	H mm	K pcs.	Price net (€)
<b>396101</b>	255	25	1	<b>12,00</b>
<b>396102</b>	305	35	1	<b>19,20</b>

## 2 DEEP PLATE

• smooth

Code	Ø mm	H mm	V liters*	K pcs.	Price net (€)
<b>396103</b>	230	55	0,18	1	<b>12,40</b>
<b>396104</b>	305	65	0,45	1	<b>22,00</b>

## 3 FLAT PLATE

• ribbed

Code	Ø mm	H mm	K pcs.	Price net (€)
<b>396112</b>	305	40	1	<b>26,30</b>

## 4 DEEP PLATE

• ribbed

Code	Ø mm	H mm	V liters*	K pcs.	Price net (€)
<b>396113</b>	265	60	0,32	1	<b>20,30</b>
<b>396114</b>	305	70	0,50	1	<b>28,30</b>



## Colour porcelain

## 1 SALAD-BOWL

Code	Ø mm	H mm	V liters*	Price net (€)
<b>396151</b>	135	75	0,6	<b>2,91</b>

## 2 FLAT PLATE

Code	Ø mm	H mm	Price net (€)
<b>396152</b>	200	30	<b>3,27</b>





## ISABELL PORCELAIN



- smooth white porcelain
- durable enamel coating
- dimensions and total capacities are approximate
- sold in case batches (K)
- price per item





**1 FLAT PLATE**

Code	Ø mm	H mm	K pcs.	Price net (€)
<b>388101</b>	170	20	12	<b>1,74</b>
<b>388102</b>	180	22	6	<b>2,42</b>
<b>388103</b>	200	23	6	<b>2,83</b>
<b>388104</b>	230	23	6	<b>3,84</b>
<b>388105</b>	240	23	4	<b>4,23</b>
<b>388106</b>	250	25	4	<b>4,29</b>
<b>388107</b>	260	25	4	<b>4,52</b>
<b>388108</b>	280	33	3	<b>6,92</b>
<b>388109</b>	310	30	3	<b>8,66</b>



**2 SALAD-BOWL**

Code	Ø mm	H mm	V liters*	K pcs.	Price net (€)
<b>388154</b>	220	40	0,500	6	<b>2,54</b>



**3 DEEP PLATE**

Code	Ø mm	H mm	V liters*	K pcs.	Price net (€)
<b>388123</b>	200	40	0,210	6	<b>3,29</b>
<b>388124</b>	230	40	0,300	4	<b>4,84</b>
<b>388125</b>	250	45	0,350	4	<b>7,19</b>
<b>388126</b>	305	45	0,550	3	<b>6,80</b>

**4 DIP**

Code	Ø mm	H mm	V liters*	K pcs.	Price net (€)
<b>388233</b>	50	18	0,020	24	<b>0,92</b>



**5 CUP**

Code	Product	Ø mm	H mm	V liters*	K pcs.	Price net (€)
<b>388239</b>	Cup	100	65	0,260	6	<b>2,17</b>
<b>388240</b>	Saucer	145	20	-	12	<b>1,29</b>



**6 CUP**

Code	Product	Ø mm	H mm	V liters*	K pcs.	Price net (€)
<b>388237</b>	Cup	85	60	0,170	12	<b>2,26</b>
<b>388238</b>	Saucer	140	20	-	12	<b>1,24</b>



**7 BROTH BOWL**

Code	Product	Ø mm	H mm	V liters*	K pcs.	Price net (€)
<b>388165</b>	Broth bowl	100	60	0,270	6	<b>2,98</b>
<b>388166</b>	Saucer	140	20	-	12	<b>1,72</b>
<b>388167</b>	Broth bowl	120	75	0,380	6	<b>4,07</b>
<b>388168</b>	Saucer	140	25	-	12	<b>2,22</b>



**1 VASE**

Code	W mm	H mm	V liters*	K pcs.	Price net (€)
<b>388170</b>	300	175	3,500	1	<b>25,20</b>

**2 FLAT PLATE**

Code	Ø mm	H mm	V liters*	K pcs.	Price net (€)
<b>388217</b>	360	35	3	3	<b>10,46</b>
<b>388218</b>	410	42	3	3	<b>14,69</b>

**3 MUG**

Code	Ø mm	H mm	V liters*	K pcs.	Price net (€)
<b>388138</b>	80	92	0,300	12	<b>2,17</b>

**4 MUG**

Code	Ø mm	H mm	V liters*	K pcs.	Price net (€)
<b>388139</b>	80	100	0,320	12	<b>2,95</b>

**5 PITCHER**

Code	W mm	H mm	V liters*	K pcs.	Price net (€)
<b>388182</b>	160	98	0,400	2	<b>5,84</b>
<b>388184</b>	170	120	0,640	2	<b>8,37</b>

**6 CUP**

Code	Opis	Ø mm	H mm	V liters*	K pcs.	Price net (€)
<b>388193</b>	Cup	85	55	0,200	12	<b>2,28</b>
<b>388194</b>	Saucer	155	24	-	12	<b>1,25</b>
<b>388195</b>	Cup	95	60	0,250	12	<b>3,16</b>
<b>388196</b>	Saucer	160	24	-	12	<b>1,87</b>

**7 SUGAR BOWL**

Code	Ø mm	H mm	V liters*	K pcs.	Price net (€)
<b>388183</b>	96	101	0,320	6	<b>3,62</b>



**1 SALAD-BOWL**

Code	W mm	D mm	H mm	V liters*	K pcs.	Price net (€)
<b>388137</b>	200	200	90	1,700	4	<b>5,32</b>

**2 POT WITH CUP AND SAUCER**

Code	W mm	H mm	V liters*	K pcs.	Price net (€)
<b>388181</b>	170	135	0,350	1	<b>14,50</b>

**3 MUG**

Code	Ø mm	H mm	V liters*	K pcs.	Price net (€)
<b>388149</b>	85	95	0,350	12	<b>2,71</b>

**4 PITCHER**

Code	W mm	H mm	V liters*	K pcs.	Price net (€)
<b>388175</b>	80	85	0,100	6	<b>2,67</b>

**5 PASTA PLATE**

Code	Ø mm	H mm	V liters*	K pcs.	Price net (€)
<b>388127</b>	270	42	0,300	4	<b>15,60</b>

**6 BOWL**

Code	Ø mm	H mm	V liters*	K pcs.	Price net (€)
<b>388156</b>	130	55	0,400	12	<b>3,42</b>
<b>388157</b>	145	65	0,550	12	<b>4,26</b>

**7 CRÈME BRÛLÉE DISH**

Code	Ø mm	H mm	V liters*	K pcs.	Price net (€)
<b>388185</b>	70	32	0,060	24	<b>1,20</b>
<b>388186</b>	80	35	0,100	24	<b>1,15</b>
<b>388187</b>	90	40	0,130	12	<b>1,45</b>

**8 PIZZA PLATE**

Code	Ø mm	H mm	K pcs.	Price net (€)
<b>388120</b>	330	15	4	<b>13,12</b>



1



2



3



4



5



6

**1 2-ELEMENT SPICE SET**

- salt shaker
- pepper shaker

Code	H mm	Price net (€)
<b>362001</b>	115	<b>5,73</b>

**2 2-ELEMENT SPICE SET WITH NAPKIN HOLDER**

- salt shaker
- pepper shaker
- napkin holder

Code	H mm	Price net (€)
<b>362002</b>	115	<b>7,76</b>

**3 4-ELEMENT SPICE SET**

- salt shaker
- pepper shaker
- 2 containers for liquid spices

Code	H mm	Price net (€)
<b>362004</b>	180	<b>12,70</b>

**4 5-ELEMENT SPICE SET**

- salt shaker
- pepper shaker
- 2 containers for liquid spices
- toothpick container

Code	H mm	Price net (€)
<b>362007</b>	180	<b>12,90</b>

**5 2-ELEMENT SPICE SET**

- salt shaker
- pepper shaker

Code	H mm	Price net (€)
<b>362020</b>	145	<b>9,67</b>

**6 ADDITIONAL SPICE CONTAINERS**

Code	Price net (€)
<b>362901</b>	<b>2,15</b>

NAPKIN HOLDER



1



2



3



4

NAPKIN HOLDER

- Cat. no. 364205 – suitable for standard 1/8 napkins when folded to 12/9 cm
- Cat. no. 364206 – suitable for 17/17 cm dispenser standard napkins

INOX



No.	Code	W mm	D mm	H mm	Price net (€)
1.	<b>364101</b>	-	-	80	<b>2,76</b>
2.	<b>364100</b>	-	-	80	<b>6,52</b>
3.	<b>364111</b>	-	-	75	<b>6,35</b>
4.	<b>364204</b>	195	195	190	<b>10,54</b>

No.	Code	W mm	D mm	H mm	Price net (€)
1.	<b>364205</b>	100	115	145	<b>9,70</b>
2.	<b>364206</b>	100	115	185	<b>9,90</b>

SNAIL ACCESSORIES



2



3

1 SNAIL PLATE

- tray for 6 servings

Code	W mm	D mm	Price net (€)
<b>368060</b>	200	170	<b>6,64</b>

2 SNAIL TONGS

Code	Price net (€)
<b>368020</b>	<b>3,17</b>

3 SNAIL FORK

Code	Price net (€)
<b>368010</b>	<b>1,29</b>



1



SAUCEBOAT



Code	V liters	Price net (€)
369150	0,15	4,64
369250	0,25	6,41
369450	0,45	8,17

EGG HOLDER



Code	H mm	Price net (€)
364241	50	1,09

SOUP VASE

- vase with two handles for easy handling
- vase lid with a cutout for ladle
- vase width with handles 290 mm



No.	Code	Product	Ø mm	L mm	H mm	V liters	Price net (€)
1.	365301	Soup vase	245	-	135	3,0	28,70
2.	365011	Ladle	80	330	-	0,09	5,84
3.	365241	Cover	245	-	-	-	18,40

SPICE GRINDER

- steel grinding mechanism
- made of rubber wood
- adjustable grinding thickness
- recommended for grinding pepper and other spices



Code	H mm	Price net (€)
362413	300	28,52

TABLE BIN

- swing cover



Code	Ø mm	H mm	V liters	Price net (€)
068203	120	160	1,5	13,20



MENU HOLDER



Code	H mm	Price net (€)
486031	102	2,28

MORTAR WITH PESTLE

- for crushing, grinding and grating herbs and spices
- made of marble (polished exterior)
- matt interior and mallet finishing



Code	Ø mm	D mm	Price net (€)
362130	120	110	21,95

## BASKETS

PP

## UNIVERSAL BASKET

- Roll-Top cover 419000 (p. 270) can be used for the basket 361611

No.	Code	Description	W mm	D mm	H mm	Price net (€)
1.	<b>361611</b>	GN 1/1	530	325	65	<b>35,60</b>
	<b>361612</b>	GN 1/2	325	265	65	<b>21,10</b>
	<b>361613</b>	GN 1/3	325	175	65	<b>16,40</b>
	<b>361614</b>	GN 1/4	265	160	65	<b>14,10</b>
	<b>361616</b>	GN 1/6	175	160	65	<b>11,50</b>
	<b>361623</b>	GN 2/3	325	355	65	<b>26,60</b>
2.	<b>361617</b>	oval	185	135	70	<b>8,20</b>



## BREAD BASKET

- reinforced with steel wire
- imitates wicker
- available in 6 GN sizes



Code	Description	W mm	D mm	H mm	Price net (€)
<b>361201</b>	GN 1/1	530	325	80	<b>30,60</b>
<b>361205</b>	GN 2/3	325	355	80	<b>20,52</b>

**BREAD BASKET WITH ROLL-TOP COVER**

- opened cover 90°



No.	Code	Description	Ø mm	W mm	D mm	Price net (€)
1.	<b>419001</b>	GN 1/1	-	530	325	<b>59,00</b>
2.	<b>419202</b>	round	395	-	-	<b>41,30</b>

**BREAD BASKET**



No.	Code	Description	Ø mm	W mm	D mm	H mm	Price net (€)
3.	<b>361230</b>	oval	-	230	150	65	<b>2,98</b>
4.	<b>361380</b>	oval	-	380	270	90	<b>16,92</b>
5.	<b>361235</b>	oval	-	235	150	70	<b>7,46</b>

**CUTLERY BASKET**



Code	W mm	D mm	H mm	Price net (€)
<b>361270</b>	270	100	50	<b>9,00</b>



# FOOD STORAGE AND TRANSPORT

Containers used for food storage and in heat treatment processes. Transport carts, together with GN containers, create an ideal solution for transporting all kinds of dishes.

GN containers .....	142-151	Tray sealing machine .....	162
Transport containers .....	152-153	Packers and packer accessories.....	158-161
Transport thermal insulation containers .....	154-157	Transport and waiter carts .....	163-164
Pizza bags .....	155	Racks .....	165-166

## STAINLESS STEEL GN CATERING CONTAINERS, COMFORT



- recommended for steaming in convection steam ovens
- cantilever slat p. 213

### GN CONTAINER 1/1 NON-STICK



Code	W mm	D mm	H mm	V liters	Price net (€)
<b>191021</b>	530	325	20	2,2	<b>37,20</b>
<b>191041</b>	530	325	40	5,0	<b>41,80</b>
<b>191061</b>	530	325	65	8,0	<b>46,50</b>

## STAINLESS STEEL GN CATERING CONTAINERS, PREMIUM



- recommended for steaming in convection steam ovens
- cantilever slat p. 213

### GN CONTAINER 1/1



### GN CONTAINER 1/1 NON-STICK



### GN LID



Code	W mm	D mm	H mm	V liters	Price net (€)
<b>111022</b>	530	325	20	2,5	<b>26,00</b>
<b>111042</b>	530	325	40	5,0	<b>29,00</b>
<b>111062</b>	530	325	65	8,8	<b>32,00</b>

Code	W mm	D mm	H mm	V liters	Price net (€)
<b>171020</b>	530	325	20	2,5	<b>42,50</b>
<b>171040</b>	530	325	40	5,5	<b>46,10</b>
<b>171060</b>	530	325	65	9,0	<b>55,80</b>

Code	Description	Price net (€)
<b>111002</b>	GN 1/1	<b>29,00</b>

Height - h

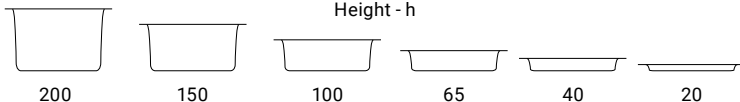

# STAINLESS STEEL GN CATERING CONTAINERS, STANDARD



GN CONTAINER 2/1



Code	W mm	D mm	H mm	V liters	Price net (€)
<b>117020</b>	650	530	20	4,4	<b>32,50</b>
<b>117040</b>	650	530	40	9,0	<b>33,50</b>
<b>117060</b>	650	530	65	18,0	<b>36,30</b>
<b>117100</b>	650	530	100	30,0	<b>44,70</b>
<b>117150</b>	650	530	150	42,0	<b>56,80</b>
<b>117200</b>	650	530	200	58,0	<b>73,30</b>

GN CONTAINER 1/1



Code	W mm	D mm	H mm	V liters	Price net (€)
<b>111020</b>	530	325	20	2,2	<b>11,90</b>
<b>111040</b>	530	325	40	5,0	<b>12,90</b>
<b>111060</b>	530	325	65	8,0	<b>14,90</b>
<b>111100</b>	530	325	100	14,0	<b>19,60</b>
<b>111150</b>	530	325	150	19,0	<b>29,80</b>
<b>111200</b>	530	325	200	26,0	<b>35,70</b>

GN CONTAINER 2/3



Code	W mm	D mm	H mm	V liters	Price net (€)
<b>115020</b>	325	354	20	1,5	<b>8,30</b>
<b>115040</b>	325	354	40	3,5	<b>10,40</b>
<b>115060</b>	325	354	65	5,5	<b>12,40</b>
<b>115100</b>	325	354	100	8,0	<b>16,90</b>
<b>115150</b>	325	354	150	12,0	<b>25,80</b>
<b>115200</b>	325	354	200	18,0	<b>30,50</b>

GN CONTAINER 1/2



Code	W mm	D mm	H mm	V liters	Price net (€)
<b>112020</b>	325	265	20	1,2	<b>6,21</b>
<b>112040</b>	325	265	40	2,0	<b>7,86</b>
<b>112060</b>	325	265	65	3,5	<b>8,53</b>
<b>112100</b>	325	265	100	6,0	<b>11,50</b>
<b>112150</b>	325	265	150	8,5	<b>18,40</b>
<b>112200</b>	325	265	200	11,5	<b>24,00</b>

GN CONTAINER 2/4



Code	W mm	D mm	H mm	V liters	Price net (€)
<b>118040</b>	162	530	40	1,75	<b>9,85</b>
<b>118060</b>	162	530	65	3,50	<b>12,10</b>
<b>118100</b>	162	530	100	5,50	<b>15,80</b>
<b>118150</b>	162	530	150	8,50	<b>26,40</b>

GN CONTAINER 1/3



Code	W mm	D mm	H mm	V liters	Price net (€)
<b>113020</b>	325	176	20	0,7	<b>5,51</b>
<b>113040</b>	325	176	40	1,5	<b>6,91</b>
<b>113060</b>	325	176	65	2,5	<b>7,40</b>
<b>113100</b>	325	176	100	3,7	<b>9,69</b>
<b>113150</b>	325	176	150	5,7	<b>16,00</b>
<b>113200</b>	325	176	200	7,3	<b>18,10</b>

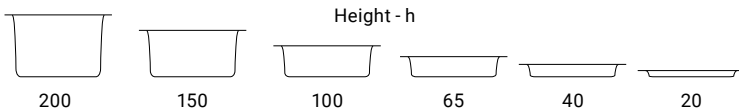





GN CONTAINER 1/4



Code	W mm	D mm	H mm	V liters	Price net (€)
<b>114020</b>	265	162	20	0,4	<b>4,39</b>
<b>114040</b>	265	162	40	1,0	<b>6,02</b>
<b>114060</b>	265	162	65	1,7	<b>8,31</b>
<b>114100</b>	265	162	100	2,8	<b>8,52</b>
<b>114150</b>	265	162	150	3,6	<b>12,90</b>
<b>114200</b>	265	162	200	5,0	<b>16,00</b>

GN CONTAINER 1/6



Code	W mm	D mm	H mm	V liters	Price net (€)
<b>116060</b>	176	162	65	1,0	<b>5,28</b>
<b>116100</b>	176	162	100	1,6	<b>7,00</b>
<b>116150</b>	176	162	150	2,0	<b>10,10</b>
<b>116200</b>	176	162	200	2,8	<b>14,20</b>

GN CONTAINER 1/9



Code	W mm	D mm	H mm	V liters	Price net (€)
<b>119060</b>	176	108	65	0,5	<b>4,32</b>
<b>119100</b>	176	108	100	0,8	<b>6,61</b>
<b>119150</b>	176	108	150	1,4	<b>8,72</b>

GN CONTAINER 1/12



Code	W mm	D mm	H mm	V liters	Price net (€)
<b>110100</b>	132	108	100	0,5	<b>5,10</b>

GN LID



Code	Description	Price net (€)
<b>117000</b>	GN 2/1	<b>38,00</b>
<b>111000</b>	GN 1/1	<b>13,70</b>
<b>115000</b>	GN 2/3	<b>11,20</b>
<b>112000</b>	GN 1/2	<b>7,88</b>
<b>118000</b>	GN 2/4	<b>8,99</b>
<b>113000</b>	GN 1/3	<b>5,34</b>
<b>114000</b>	GN 1/4	<b>4,91</b>
<b>116000</b>	GN 1/6	<b>3,51</b>
<b>119000</b>	GN 1/9	<b>2,88</b>

AIRTIGHT LID



Code	Description	Price net (€)
<b>111014</b>	GN 1/1	<b>36,10</b>
<b>115014</b>	GN 2/3	<b>29,70</b>
<b>112014</b>	GN 1/2	<b>25,80</b>
<b>113014</b>	GN 1/3	<b>19,40</b>
<b>114014</b>	GN 1/4	<b>18,30</b>
<b>116014</b>	GN 1/6	<b>12,10</b>

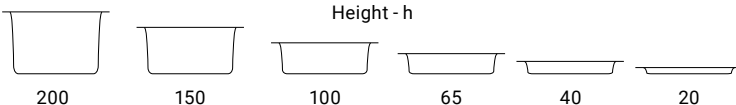

# STAINLESS STEEL GN CATERING CONTAINERS, WITH MOBILE HANDGRIPS, STANDARD



- recommended for baine maries and heat-insulated containers
- cantilever slat p. 213

GN CONTAINER 1/1



Code	W mm	D mm	H mm	V liters	Price net (€)
<b>131104</b>	530	325	100	14,0	<b>19,38</b>
<b>131204</b>	530	325	200	26,0	<b>35,38</b>

GN CONTAINER 1/2



Code	W mm	D mm	H mm	V liters	Price net (€)
<b>132104</b>	325	265	100	6,0	<b>12,83</b>
<b>132204</b>	325	265	200	11,5	<b>20,67</b>

GN CONTAINER 1/3



Code	W mm	D mm	H mm	V liters	Price net (€)
<b>133104</b>	325	176	100	3,7	<b>11,39</b>
<b>133154</b>	325	176	150	5,7	<b>15,47</b>
<b>133204</b>	325	176	200	7,3	<b>18,27</b>

GN CONTAINER 1/6



Code	W mm	D mm	H mm	V liters	Price net (€)
<b>136104</b>	176	162	100	1,6	<b>8,58</b>
<b>136204</b>	176	162	200	2,8	<b>13,44</b>

GN COVER WITH HOLES FOR THE HANDLE

Code	Description	Price net (€)
<b>131000</b>	GN 1/1	<b>12,91</b>
<b>132000</b>	GN 1/2	<b>7,60</b>
<b>133000</b>	GN 1/3	<b>5,23</b>

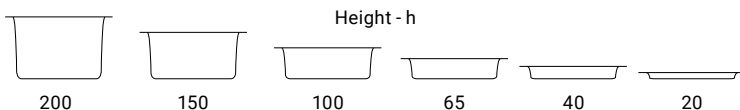

# STAINLESS STEEL GN CATERING CONTAINERS, PERFORATED, STANDARD



• recommended for steaming in convection steam ovens

GN CONTAINER 1/1



Code	W mm	D mm	H mm	V liters	Price net (€)
<b>121024</b>	530	325	20	2,2	<b>17,30</b>
<b>121044</b>	530	325	40	5,0	<b>17,90</b>
<b>121064</b>	530	325	65	8,0	<b>19,00</b>
<b>121104</b>	530	325	100	14,0	<b>25,10</b>
<b>121154</b>	530	325	150	19,0	<b>35,80</b>
<b>121204</b>	530	325	200	26,0	<b>40,50</b>

GN CONTAINER 2/3



Code	W mm	D mm	H mm	V liters	Price net (€)
<b>125064</b>	325	354	65	5,5	<b>14,20</b>
<b>125104</b>	325	354	100	8,0	<b>18,70</b>

GN CONTAINER 1/2



Code	W mm	D mm	H mm	V liters	Price net (€)
<b>122064</b>	325	265	65	3,5	<b>11,40</b>
<b>122104</b>	325	265	100	6,0	<b>13,80</b>
<b>122154</b>	325	265	150	8,5	<b>22,70</b>

• CANTILEVER SLAT

• allows placing GN containers in refrigerated counters, baine maries, thermoses, etc.



Code	L mm	Price net (€)
<b>100321</b>	325	<b>6,89</b>
<b>100531</b>	530	<b>7,98</b>

# STEEL GN CATERING CONTAINERS, STANDARD



• made of enamel-coated steel, conduct heat well

GN CONTAINER 2/1



Code	W mm	D mm	H mm	V liters	Price net (€)
<b>107021</b>	650	530	20	4,4	<b>27,97</b>
<b>107061</b>	650	530	65	18,0	<b>41,70</b>



GN CONTAINER 1/1



Code	W mm	D mm	H mm	V liters	Price net (€)
<b>101021</b>	530	325	20	2,2	<b>14,20</b>
<b>101041</b>	530	325	40	5,0	<b>16,90</b>
<b>101061</b>	530	325	65	8,0	<b>19,30</b>

GN CONTAINER 2/3



Code	W mm	D mm	H mm	V liters	Price net (€)
<b>105041</b>	325	354	40	3,5	<b>9,75</b>

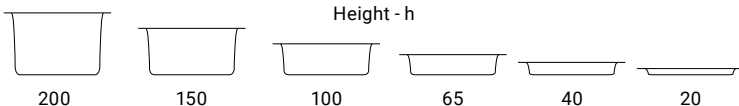

# STAINLESS STEEL GN CATERING CONTAINERS, BASIC

• cantilever slat p. 227



GN CONTAINER 1/1

Code	W mm	D mm	H mm	V liters	Price net (€)
<b>111026</b>	530	325	20	2,2	<b>8,69</b>
<b>111046</b>	530	325	40	5,0	<b>10,07</b>
<b>111066</b>	530	325	65	8,0	<b>12,07</b>
<b>111106</b>	530	325	100	14,0	<b>15,39</b>
<b>111156</b>	530	325	150	19,0	<b>21,38</b>
<b>111206</b>	530	325	200	26,0	<b>28,41</b>

GN CONTAINER 1/2



Code	W mm	D mm	H mm	V liters	Price net (€)
<b>112026</b>	325	265	20	1,2	<b>4,81</b>
<b>112046</b>	325	265	40	2,0	<b>6,57</b>
<b>112066</b>	325	265	65	3,5	<b>7,03</b>
<b>112106</b>	325	265	100	6,0	<b>10,36</b>
<b>112156</b>	325	265	150	8,5	<b>14,16</b>
<b>112206</b>	325	265	200	11,5	<b>18,62</b>

GN CONTAINER 1/3



Code	W mm	D mm	H mm	V liters	Price net (€)
<b>113066</b>	325	176	65	2,5	<b>6,57</b>
<b>113106</b>	325	176	100	3,7	<b>9,28</b>
<b>113156</b>	325	176	150	5,7	<b>12,54</b>
<b>113206</b>	325	176	200	7,3	<b>16,63</b>

GN CONTAINER 1/4



Code	W mm	D mm	H mm	V liters	Price net (€)
<b>114066</b>	265	162	65	1,7	<b>5,42</b>
<b>114106</b>	265	162	100	2,8	<b>7,04</b>
<b>114156</b>	265	162	150	3,6	<b>10,45</b>
<b>114206</b>	265	162	200	5,0	<b>12,73</b>

GN CONTAINER 1/6



Code	W mm	D mm	H mm	V liters	Price net (€)
<b>116066</b>	176	162	65	1,0	<b>4,59</b>
<b>116106</b>	176	162	100	1,6	<b>6,22</b>
<b>116156</b>	176	162	150	2,0	<b>8,60</b>
<b>116206</b>	176	162	200	2,8	<b>11,69</b>

GN CONTAINER 1/9



Code	W mm	D mm	H mm	V liters	Price net (€)
<b>119066</b>	176	108	65	0,5	<b>4,00</b>
<b>119106</b>	176	108	100	0,8	<b>6,00</b>

GN LID



Code	Description	Price net (€)
<b>111006</b>	GN 1/1	<b>10,70</b>
<b>112006</b>	GN 1/2	<b>5,70</b>
<b>113006</b>	GN 1/3	<b>4,83</b>
<b>114006</b>	GN 1/4	<b>4,58</b>
<b>116006</b>	GN 1/6	<b>3,34</b>
<b>119006</b>	GN 1/9	<b>2,45</b>

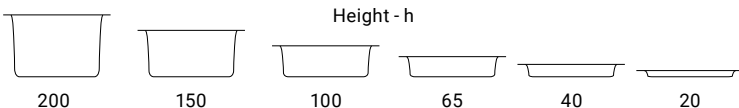

# POLYPROPYLENE GN CATERING CONTAINERS, STANDARD



• do not use in bain maries and convection steam ovens

GN CONTAINER 1/1



Code	W mm	D mm	H mm	V liters	Price net (€)
<b>161062</b>	530	325	65	8,0	<b>9,44</b>
<b>161102</b>	530	325	100	14,0	<b>10,91</b>
<b>161152</b>	530	325	150	19,0	<b>12,74</b>
<b>161202</b>	530	325	200	26,0	<b>18,00</b>

GN CONTAINER 1/2



Code	W mm	D mm	H mm	V liters	Price net (€)
<b>162062</b>	325	265	65	3,5	<b>4,90</b>
<b>162102</b>	325	265	100	6,0	<b>5,85</b>
<b>162152</b>	325	265	150	8,5	<b>7,10</b>
<b>162202</b>	325	265	200	11,5	<b>8,31</b>

GN CONTAINER 1/3



Code	W mm	D mm	H mm	V liters	Price net (€)
<b>163062</b>	325	176	65	2,5	<b>4,70</b>
<b>163102</b>	325	176	100	3,7	<b>5,48</b>
<b>163152</b>	325	176	150	5,7	<b>6,42</b>
<b>163202</b>	325	176	200	7,3	<b>6,85</b>

GN CONTAINER 1/4



Code	W mm	D mm	H mm	V liters	Price net (€)
<b>164062</b>	265	162	65	1,7	<b>3,21</b>
<b>164102</b>	265	162	100	2,8	<b>3,95</b>
<b>164152</b>	265	162	150	3,6	<b>5,96</b>

GN CONTAINER 1/6



Code	W mm	D mm	H mm	V liters	Price net (€)
<b>166062</b>	176	162	65	1,0	<b>2,94</b>
<b>166102</b>	176	162	100	1,6	<b>3,41</b>
<b>166152</b>	176	162	150	2,0	<b>5,02</b>

GN LID



Code	Description	Price net (€)
<b>161002</b>	GN 1/1	<b>5,85</b>
<b>162002</b>	GN 1/2	<b>3,21</b>
<b>163002</b>	GN 1/3	<b>2,53</b>
<b>164002</b>	GN 1/4	<b>2,21</b>
<b>166002</b>	GN 1/6	<b>1,83</b>

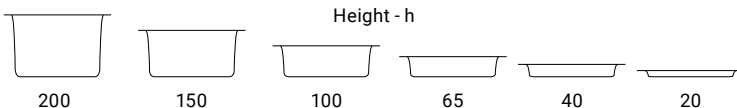

# POLYPROPYLENE GN CATERING CONTAINERS, PREMIUM

- made of transparent polypropylene without Bisphenol
- do not use in bain maries and convection steam ovens



GN CONTAINER 1/1



Code	W mm	D mm	H mm	V liters	Price net (€)
161061	530	325	65	9,0	13,80
161101	530	325	100	13,3	15,50
161201	530	325	200	26,4	23,40

GN CONTAINER 1/2



Code	W mm	D mm	H mm	V liters	Price net (€)
162101	325	265	100	6,1	8,89
162201	325	265	200	11,9	13,10

GN CONTAINER 1/3



Code	W mm	D mm	H mm	V liters	Price net (€)
163101	325	175	100	3,8	8,35
163151	325	175	150	5,5	8,69

GN CONTAINER 1/4



Code	W mm	D mm	H mm	V liters	Price net (€)
164101	265	164	100	2,6	6,44
164151	265	164	150	3,8	8,35

GN CONTAINER 1/6



Code	W mm	D mm	H mm	V liters	Price net (€)
166101	176	162	100	1,6	5,22
166151	176	162	150	2,3	6,57

GN CONTAINER 1/9



Code	W mm	D mm	H mm	V liters	Price net (€)
169061	176	108	65	0,6	3,71
169101	176	108	100	0,9	4,38

## LATCH COVER GN

Code	Description	Price net (€)
161014	GN 1/1	6,41
162014	GN 1/2	4,96
163014	GN 1/3	3,66
164014	GN 1/4	2,86
166014	GN 1/6	2,45
169014	GN 1/9	2,80

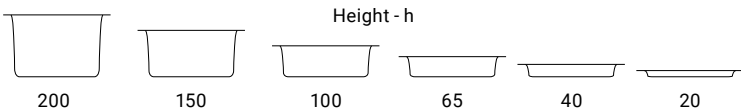



## POLYPROPYLENE GN CATERING CONTAINERS WITH LID

- made of translucent polypropylene with ColorClip system - a set of colored clips for marking the lid and container
- do not absorb odors and flavors
- cover included
- do not use in bain maries and ovens



GN CONTAINER 1/1



Code	W mm	D mm	H mm	V liters	Price net (€)
161155	530	325	150	21,0	35,30
161205	530	325	200	28,0	39,10

GN CONTAINER 2/3



Code	W mm	D mm	H mm	V liters	Price net (€)
165155	325	354	150	13,5	32,10
165205	325	354	200	19,0	34,80

GN CONTAINER 1/2



Code	W mm	D mm	H mm	V liters	Price net (€)
162105	325	265	100	6,5	25,40
162155	325	265	150	10,0	27,10
162205	325	265	200	12,5	32,20

GN CONTAINER 1/3



Code	W mm	D mm	H mm	V liters	Price net (€)
163105	325	176	100	4,0	17,80
163155	325	176	150	6,0	19,30

GN CONTAINER 1/4



Code	W mm	D mm	H mm	V liters	Price net (€)
164105	265	162	100	2,8	10,70
164155	265	162	150	4,3	11,70

GN CONTAINER 1/6



Code	W mm	D mm	H mm	V liters	Price net (€)
166105	176	162	100	1,7	8,91
166155	176	162	150	2,6	9,51



FOOD STORAGE AND TRANSPORT



GN CONTAINER 1/9



Code	W mm	D mm	H mm	V liters	Price net (€)
169065	176	108	65	0,6	6,06
169105	176	108	100	1,0	7,00
169155	176	108	150	1,5	8,49



Label



ColorClip system



MON



TUE



WED



THU



FRI



SAT



SUN

Height - h



200



150



100



65



40



20

CONTAINER

- specially designed grips for easy container handling
- containers have a scale
- temperature range from -5°C to +70°C



Code	Ø mm	H mm	V liters	Price net (€)
<b>067110</b>	310	210	10,0	<b>12,70</b>
<b>067120</b>	310	375	20,0	<b>19,80</b>

LID



Code	Ø mm	Price net (€)
<b>067194</b>	310	<b>4,70</b>

TRANSPORT CONTAINER

- food container with tightly fitting lid
- has a reinforced base and contoured handles
- holes in the handles to prevent moisture residue after washing
- properly profiled bottom and cover allow for stacking
- containers GN 1/1 200 can be stacked inside containers 062531 and 062532
- containers 2xGN 1/1 150 can be stacked inside containers 062761 and 062762

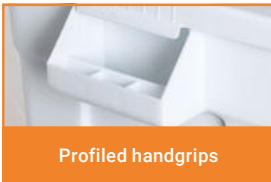

No.	Code	Colour	W mm	D mm	H mm	V liters	Price net (€)
1.	<b>062531</b>	○	710	440	270	53	<b>64,10</b>
	<b>062761</b>	○	710	440	380	79	<b>83,40</b>
2.	<b>062532</b>	●	710	440	270	53	<b>64,10</b>
	<b>062762</b>	●	710	440	380	79	<b>83,40</b>

**FIFO CONTAINER**

- easy stocks control (FIFO)
- split cover, loading and unloading
- fitted with the ColorClip system - a set of colored clips for marking the lid and container (2x4 clips - green, blue, yellow, red)



Code	W mm	D mm	H mm	V liters	Price net (€)
<b>064100</b>	565	340	200	22,6	<b>33,70</b>
<b>064101</b>	415	340	200	16,0	<b>29,90</b>
<b>064102</b>	395	200	200	7,0	<b>16,20</b>

**EGG CONTAINER**

- 8 trays included (4 trays in container + 4 replacement trays)
- capacity per tray - 30 eggs



Code	W mm	D mm	H mm	Price net (€)
<b>061500</b>	354	325	200	<b>49,00</b>

**ICE TRANSPORT CONTAINER**

- double walls
- "monobloc" design
- drip tray
- two casters with a brake
- drain valve



Code	Colour	W mm	D mm	H mm	V liters	Price net (€)
<b>053125</b>	●	590	815	745	125	<b>989,80</b>

# POLYETHYLENE TRANSPORT THERMAL CONTAINERS



- made of khaki-colored polyethylene
- very durable due to thick insulation made of polyurethane foam
- suitable for transporting hot or cold dishes in steel, polycarbonate or polypropylene GN containers
- equipped with a release vent



Robust grips for handling



Vent valve

## VACUUM FLASK

- special guides for GN containers
- two ergonomic grips for handling
- removable door seal
- door opened by 270°
- the flask can be used with a cart 059002 p. 272
- internal dimensions (WxDxH): 535 x 325 x 495 mm

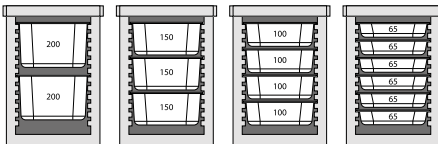

Code	W mm	D mm	H mm	V liters	Price net (€)
<b>053870</b>	650	450	625	86	<b>394,00</b>

## VACUUM FLASK

- lid closed with four latches
- volume: GN 1/1 200 mm

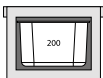

Code	W mm	D mm	H mm	V liters	Price net (€)
<b>054300</b>	645	445	315	26	<b>270,00</b>

**PIZZA BAG**

- made of durable vinyl material
- thick insulation retains the temperature, prevents moisture penetration
- large, tilting flap with velcro
- transparent pocket for bills with dimensions (WxD) 165x120 mm
- has comfortable grip for handling and vents



Vents to drain excess moisture



Code	W mm	D mm	H mm	W (usable) mm	D (usable) mm	H (usable) mm	Price net (€)
<b>563453</b>	500	500	300	480	480	285	<b>21,10</b>

**PIZZA BAG**

- made of strong material - nylon, damage-resistant
- polyester insulation maximally retains temperature, prevents moisture and smell penetration
- large, tilting flap
- transparent pocket for bills 120x180 mm
- has a hanger knot and ventilation holes



Transparent pocket 120x180 mm



Code	W mm	D mm	H mm	W (usable) mm	D (usable) mm	H (usable) mm	Price net (€)
<b>563452</b>	550	500	200	510	500	200	<b>22,28</b>

**PLASTIC THERMOS**

- made of low-density polyethylene for food contact
- double walls
- "monobloc" design
- impact resistant
- recyclable
- non-drip faucet



No.	Code	Colour	W mm	D mm	H mm	V liters	Price net (€)
1.	<b>053100</b>	●	295	420	500	10	<b>253,00</b>
2.	<b>053200</b>	●	295	420	675	20	<b>286,00</b>

## BASIC LINE STEEL VACUUM FLASKS



- lid with silicone seal, abrasion resistant, fitted with 6 latches
- double walls and lid insulated with special foam retaining heat for 8 hours
- grip located on the lid serves to move the lid only



### VACUUM FLASK

Code	Ø mm	H mm	V liters	Price net (€)
<b>051101</b>	330	210	10	<b>155,00</b>
<b>051151</b>	330	270	15	<b>177,00</b>
<b>051201</b>	330	365	20	<b>196,00</b>
<b>051301</b>	330	450	30	<b>227,00</b>

# S.S.T. CONTAINERS WITH THERMAL INSULATION



- thermal containers to transport food
- lid with silicone seal, abrasion resistant, fitted with 6 latches
- base of flexible plastic to protect against mechanical damage to the thermoses and floor
- they have a vent valve to eliminate underpressure
- grip located on the lid serves to move the lid only

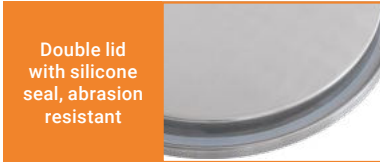

Double lid with silicone seal, abrasion resistant



Six latches holding the lid



Double walls and lid insulated with special foam retaining heat for 8 hours



Vacuum flasks for beverages with a tap

The temperature distribution of food in the steel container under the following conditions:

- initial temperature of food +95°C
- ambient temp. +20°C
- container fully loaded

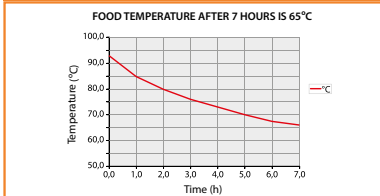

## VACUUM FLASK



Code	Ø mm	H mm	V liters	Price net (€)
<b>051104</b>	330	235	10	<b>195,00</b>
<b>051154</b>	330	295	15	<b>210,00</b>
<b>051204</b>	330	365	20	<b>243,00</b>
<b>051254</b>	330	440	25	<b>256,00</b>
<b>051304</b>	330	475	30	<b>274,00</b>
<b>051354</b>	330	585	35	<b>296,00</b>
<b>051504</b>	480	400	50	<b>320,00</b>

## VACUUM FLASK WITH TAP



Code	Ø mm	H mm	V liters	Price net (€)
<b>052154</b>	330	295	15	<b>225,00</b>
<b>052204</b>	330	365	20	<b>262,00</b>
<b>052254</b>	330	585	25	<b>272,00</b>



# COMPARTMENT VACUUM PACKING UNITS



- appliances for vacuum-packing of food and liquid products
- ideal for packing all kinds of Products
- device used in the sous vide cooking process at low temperatures
- while using the devices, you can use both slotted bags as well as smooth bags
- electronic control

## COMPARTMENT VACUUM PACKING UNIT FOR PACKING LIQUIDS

- electronic pressure indicator
- length of the seal strip 254 mm
- seal width - single seal 3.5 mm
- ability to work in automatic and manual cycle
- possibility to change the time of suction and the time of bag sealing
- possibility of additional manual settings of the suction level
- the packing unit has the function of marinating dishes
- efficient air pump 25 l/h
- max thickness of the bags used 125 µ
- dedicated bags for packaging liquids, see p. 237
- max height of the Product packed 84 mm



Possibility of packing liquids



Code	W mm	D mm	H mm	Chamber size WxDxH mm	M kg	P kW	U V	Price net (€)
<b>691312</b>	346	249	421	315x30-80x261	14,5	0,4	230	<b>848,30</b>

## VACUUM PACKING MACHINE

- manometric pressure indicator
- length of the sealing bar 290 mm
- seal width (single weld) 4 mm
- smooth and knurled bags
- automatic and manual cycle
- setting of suction and bag sealing time
- efficient air pump 77 l/h
- max. thickness of the bags 120 µ -max. height of the packed product 110 mm



Code	W mm	D mm	H mm	Chamber size WxDxH mm	P kW	U V	Price net (€)
<b>691310</b>	360	430	378	300x350x50	0,63	230	<b>1281,00</b>

**VACUUM PACKER**

- pressure gauge
- length of the seal strip 260 mm in model 691313
- length of the seal strip 300 mm in model 691314
- seal width - single seal 5mm
- possibility of using smooth and knurled bags
- ability to work in automatic and manual cycle
- possibility to change the time of suction and the time of bag sealing
- efficient oil pump 130 l/h in model 691313
- max thickness of the bags used 120 µm
- max. height of the Products packed 110 mm

Code	W mm	D mm	H mm	Chamber size WxDxH mm	P kW	U V	Price net (€)
<b>691313</b>	330	480	356	280x393x50	1	230	<b>1349,98</b>



**VACUUM PACKER**

- electronic pressure indicator
- length of the seal strip 290 mm
- seal width - single seal 3.5 mm
- possibility of using smooth and knurled bags
- ability to work in automatic and manual cycle
- possibility to change the time of suction and the time of bag sealing
- possibility of additional manual settings of the suction level
- the packing unit has the function of marinating dishes
- efficient air pump 77 l/h
- max thickness of the bags used 120 µm
- max height of the Product packed 110 mm

Code	W mm	D mm	H mm	Chamber size WxDxH mm	P kW	U V	Price net (€)
<b>691311</b>	360	470	378	300x350x50	0,63	230	<b>1167,90</b>



**VACUUM PACKER**

- pressure gauge
- length of the seal strip 350 mm in model 691350
- seal width - double seal 2x3.5mm
- possibility of using smooth and knurled bags
- ability to work in automatic and manual cycle
- possibility to change the time of suction and the time of bag sealing
- efficient oil pump Busch 133l/h in model 691350
- max thickness of the bags used 130µm

Code	W mm	D mm	H mm	Chamber size WxDxH mm	P kW	U V	Price net (€)
<b>691350</b>	450	525	385	370x350x150	0,40	230	<b>3600,00</b>



## STRIP VACUUM PACKING MACHINES



- appliances for vacuum-packing of food products
- ideal for packaging loose products and delicate dry products
- dedicated as an auxiliary unit
- only slit bags should be used

### STRIP PACKER

- electronic pressure indicator
- length of the seal strip 310 mm
- seal width - single seal 5 mm
- ability to work in automatic and manual cycle
- possibility to change the time of suction and the time of bag sealing
- possibility of additional manual settings of the suction level
- the packing unit has the function of marinating dishes
- has a port for connecting accessories (vacuum packaging of containers and bottles)
- efficient pump 23 l/h



Code	W mm	D mm	H mm	P kW	U V	Price net (€)
<b>691304</b>	390	275	150	0,7	230	<b>373,00</b>

### STRIP PACKER

- electronic pressure indicator
- length of the seal strip 390 mm
- seal width - single seal 5 mm
- ability to work in automatic and manual cycle
- possibility to change the time of suction and the time of bag sealing
- possibility of additional manual settings of the suction level
- the packing unit has the function of marinating
- efficient pump 16 l/h



Code	W mm	D mm	H mm	P kW	U V	Price net (€)
<b>691301</b>	483	205	198	0,67	230	<b>482,00</b>

**SOUS-VIDE INSULATING BALLS**

- reduce heat losses by up to 90%
- reduce evaporation and water losses
- increase thermal stability
- reduce energy consumption



Code	K pcs	Price net (€)
<b>691190</b>	100	<b>22,00</b>

**VACUUM BAGS STAND**

- dedicated for packing unit for liquids, code 691312
- made out of stainless steel



Code	Price net (€)
<b>691251</b>	<b>48,87</b>

**VACUUM BAGS**

- plain bags for chamber pack machines
- bags for cooking in convection steam ovens
- air-tight bags ensure the product's longer shelf life
- can be used in the temperature range from -18 to +120°C
- the package contains (K) pieces, price per pack



Code	W mm	D mm	T °C	K pcs	Price net (€)
<b>691921</b>	150	250	up to 120	100	<b>17,00</b>
<b>691922</b>	200	300	up to 120	100	<b>27,00</b>
<b>691923</b>	250	350	up to 120	100	<b>39,00</b>

**VACUUM BAGS**

- plain bags for chamber pack machines
- air-tight bags ensure the product's longer shelf life
- can be used in the temperature range from -18 to +99°C
- bag thickness 0.75 µm
- the package contains (K) pieces, price per pack



Code	W mm	D mm	T °C	K pcs	Price net (€)
<b>691914</b>	160	230	-18 up to 99	100	<b>7,50</b>
<b>691915</b>	200	300	-18 up to 99	100	<b>12,30</b>
<b>691916</b>	250	350	-18 up to 99	100	<b>15,90</b>

**VACUUM BAGS**

- slit bags (knurled) for strip packers
- air-tight bags ensure the product's longer shelf life
- can be used in the temperature range from -18 to +99°C
- bag thickness 0.75/0.95 µm
- the package contains (K) pieces, price per pack



Code	W mm	D mm	T °C	K pcs	Price net (€)
<b>691907</b>	160	230	-18 up to 99	100	<b>11,00</b>
<b>691908</b>	200	300	-18 up to 99	100	<b>17,00</b>
<b>691909</b>	250	350	-18 up to 99	100	<b>25,00</b>

**VACUUM BAGS FOR PACKAGING LIQUIDS**

- plain bags for chamber pack machines
- adapted for packing chilled liquids and other food products
- vertical hanging holes
- can be used in the temperature range from -18 to 99°C
- dedicated for 691312
- the package contains (K) pieces, price per pack



Code	W mm	D mm	H mm	V liters	T °C	K pcs	Price net (€)
<b>691924</b>	140	230	55	1,0	-18 up to 99	50	<b>14,85</b>
<b>691925</b>	200	300	55	2,0	-18 up to 99	50	<b>20,70</b>
<b>691926</b>	250	300	55	2,5	-18 up to 99	50	<b>24,30</b>

## TRAY SEALING MACHINE

- professional device for catering companies
- easy and quick to use
- an effective way of packing ready meals
- hygienic and tight packaging

### TRAY SEALING MACHINE

- made of high quality stainless steel
- smooth and precise temperature control
- automatic foil cut-off
- stretcher to prevent foil curling
- welding pressure damper
- insulated handle to prevent overheating
- welding surface covered with a specialized eflon
- non-slip feet
- on / off light indication system with flooding protection
- warm-up time up to 10 minutes
- foil sealing time up to 3 seconds
- temperature control range 0-220 °C
- tray matrix included

### MATRIX

- made of a special corrosion-resistant aluminum alloy

Single-chamber matrix included



No.	Code	Product	W mm	D mm	H mm	P kW	U V	Price net (€)
1.	<b>691935</b>	Tray sealing machine	260	565	220	0,65	230	<b>970,00</b>
2.	<b>691936</b>	Two-chamber matrix	-	-	-	-	-	<b>103,00</b>
3.	<b>691937</b>	Three-chamber matrix	-	-	-	-	-	<b>103,00</b>

**PLATFORM CART**

- non-slip points on the surface
- work surface dimensions 660 x 485 mm



Code	W mm	D mm	H mm	Price net (€)
<b>059002</b>	730	480	890	<b>136,00</b>

**PLATFORM CART**

- folded
- working area dimensions 650x475 mm
- does not have wheel lock



Code	W mm	D mm	H mm	Price net (€)
<b>059001</b>	740	480	870	<b>321,00</b>

**TRANSPORT CART FOR GN CONTAINERS AND BAKING TRAYS**



- fitted with double-sided locking for GN containers and trays
- 4 swivel castors, 2 with brakes
- distance between shelves 80 mm
- volume:
  - 662111 14 x container GN 1/1
  - 662211 14 x container GN 2/1
  - 662461 16 x baking tray 600 x 400 mm

Has double-sided protection against the containers sliding out



No.	Code	W mm	D mm	H mm	Price net (€)
1.	<b>662111</b>	380	550	1735	<b>273,00</b>
	<b>662211</b>	590	670	1735	<b>369,00</b>
2.	<b>662461</b>	470	620	1735	<b>361,00</b>



# SERVING CARTS



- intended for small and large catering establishments
- particularly recommended for restaurants, banquet and wedding halls, canteens and catering establishments
- rubber wheels, 2 with brakes
- working area dimensions 800x500 mm

## SERVING CART ECO



Code	Product	W mm	D mm	H mm	Price net (€)
<b>661022</b>	2-shelf cart	860	540	940	<b>123,00</b>
<b>661033</b>	3-shelf cart	860	540	940	<b>160,00</b>

## SERVING CART STANDARD



Code	Product	W mm	D mm	H mm	Price net (€)
<b>661020</b>	2-shelf cart	845	525	940	<b>155,00</b>
<b>661030</b>	3-shelf cart	845	525	940	<b>197,00</b>

## SERVING CART PREMIUM

- ideal for catering
- for self-assembly
- may be covered e.g. with a tablecloth



Code	Product	W mm	D mm	H mm	Price net (€)
<b>661040</b>	2-shelf cart	850	530	800	<b>165,00</b>
<b>661050</b>	3-shelf cart	850	530	800	<b>190,00</b>

## SERVING CART



- intended for large and small catering establishments
- recommended as a waiter cart and an independent, mobile workplace with the possibility of storage
- made of durable plastic
- working area dimensions 620x420 mm
- 4 swivel castors, 2 with brakes
- distance between shelves 290 mm



Code	W mm	D mm	H mm	Price net (€)
<b>661035</b>	860	425	910	<b>149,00</b>





**CHROME STEEL RACK**

- intended for warehouses, stores, catering kitchens
- 4 adjustable shelves
- the load capacity per rack shelf is up to 150 kg

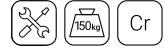

Easy to assemble



Code	W mm	D mm	H mm	M kg	Price net (€)
<b>680200</b>	900	455	1800	10,6	<b>128,00</b>

**CHROME STEEL RACK**

- shelf mount with height adjustment
- the load capacity per rack shelf is up to 200 kg
- for use in warehouses, stores, etc.



Shelf mount with height adjustment



Code	W mm	D mm	H mm	Price net (€)
<b>680062</b>	610	455	1800	<b>179,00</b>
<b>680092</b>	910	455	1800	<b>221,00</b>
<b>680123</b>	1200	450	1800	<b>196,80</b>
<b>680122</b>	1220	455	1800	<b>276,00</b>
<b>680152</b>	1525	455	1800	<b>311,00</b>
<b>681062</b>	610	610	1800	<b>208,00</b>
<b>681123</b>	1213	610	1800	<b>248,06</b>
<b>681092</b>	910	610	1800	<b>250,00</b>
<b>681102</b>	1060	610	1800	<b>299,00</b>
<b>681122</b>	1220	610	1800	<b>332,00</b>
<b>681152</b>	1525	610	1800	<b>391,00</b>
<b>681182</b>	1825	610	1800	<b>450,00</b>



## STORAGE RACK GN 1/1

- dedicated for warehouses, cold room, bakeries, etc.
- solid construction
- shelves made of polypropylene, - can be put into a dishwasher
- possible to change shelves into GN
- 4 levels of shelves, 8 modules exchangeable with GN 1/1 container
- adjustable feet
- easy assemble



Allows placing GN containers on the rack crossbars



The shelves are dishwasher-safe



Code	W mm	D mm	H mm	Price net (€)
<b>686100</b>	1120	360	1800	<b>345,60</b>



# BUFFET TABLEWARE

Buffet equipment for storing, serving, transporting and serving ready meals and beverages, both during outdoor events and directly at the premises.

Heating lamps for dishes.....	168	Beverage cooling unit.....	183
Heaters, heater fuel.....	169-174	Platters.....	184
Soup cookers, kettles.....	175-176, 179	Buffet columns.....	189
Pitchers, table vacuum flasks.....	180-181	Finger food slate plates.....	190
Trays.....	185-188	Finger food utensils.....	191-193

# HEATING LAMPS FOR DISHES



## FOOD HEATING LAMP

- movable post



Code	Ø mm	H mm	P kW	U V	Price net (€)
<b>692400</b>	270	700	0,25	230	<b>186,00</b>

## FOOD HEATING LAMP

- 2 heating elements
- possibility of placing the GN 1/1 tray
- wymiar podstawy 360x480 mm



Code	Ø mm	W mm	D mm	H mm	P kW	U V	Price net (€)
<b>692500</b>	170	360	480	600	0,5	230	<b>142,00</b>

## BULB FOR HEATING LAMPS



Code	Ø mm	H mm	P kW	U V	Price net (€)
<b>692510</b>	140	175	0,25	230	<b>8,88</b>

## FOOD HEATING LAMP

- height adjustment from 90 cm to 170 cm



Code	Colour	Ø mm	P kW	U V	Price net (€)
<b>692600</b>	●	173	0,25	230	<b>82,80</b>
<b>692601</b>	●	173	0,25	230	<b>82,80</b>
<b>692602</b>	●	173	0,25	230	<b>90,70</b>

## FOOD HEATING LAMP

- height adjustment from 90 cm to 170 cm



Code	Colour	Ø mm	P kW	U V	Price net (€)
<b>692610</b>	●	290	0,25	230	<b>89,70</b>
<b>692611</b>	●	290	0,25	230	<b>89,70</b>
<b>692612</b>	●	290	0,25	230	<b>99,00</b>

## CATERING HEATERS

- catering heaters offer for serving dishes at optimal temperatures
- the power source may be flammable fuel or an electric heater
- the containers' size and volume of the can be adjusted to the user's individual needs
- the Catering, Buffet and Hotel lines allow equipping every catering facility or catering company

## CATERING LINE

INOX

- an economy line designed for frequent use requirements
- equipped with removable covers, with the option of suspension or Roll-Top
- all heaters have handling grips

### ROUND HEATER

- complete with: 1 fuel container,  
1 round food container, lid

Code	Ø mm	H mm	V liters	Price net (€)
<b>431400</b>	420	270	4	<b>62,20</b>



### GN 1/1 HEATER

- complete with: 2 fuel containers  
and 1 container GN 1/1 65 mm



Code	W mm	D mm	H mm	V liters	Price net (€)
<b>436110</b>	605	360	240	9	<b>59,20</b>

**GN 1/1 HEATER**

- complete with: 2 fuel containers and 1 container GN 1/1 65 mm



Code	W mm	D mm	H mm	V liters	Price net (€)
<b>436120</b>	605	360	240	9	<b>55,70</b>

**ROLL-TOP HEATER GN 1/1**

- opened monoblock cover (90°)
- complete with: 2 fuel containers, container GN1/1 65 mm



Heater fixing



Code	W mm	D mm	H mm	V liters	Price net (€)
<b>434090</b>	600	360	380	9	<b>155,00</b>

# BUFFET LINE

INOX

- an elegant line of high-quality heaters with a universal system of hinged covers and Roll-Tops, facilitating their operation
- models in this line allow choosing the heating method

## ROLL-TOP HEATER

- model 437041 includes a 1/1 65 mm container 65 and 2 fuel containers
- soft-closing lid with easy and quick disassembly

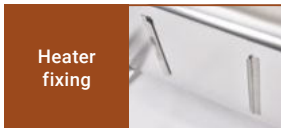

Heater fixing

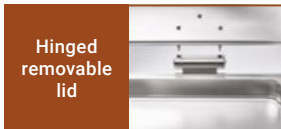

Hinged removable lid



Code	Description	W mm	D mm	H mm	Price net (€)
<b>437041</b>	GN1/1	575	410	345	<b>165,00</b>

## ROLL-TOP HEATER GN 1/1

- opened cover 180°
- including: 2 fuel containers, container GN1/1 65 mm



Heater mounting brackets

Code	W mm	D mm	H mm	V liters	Price net (€)
<b>437011</b>	660	335	400	9	<b>219,00</b>

## GN 1/1 ELECTRIC HEATER

- tub made of heat-resistant plastics
- heater with thermostat
- including: GN 1/1 container 65 mm

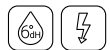

**SUNNEX®**

Code	W mm	D mm	H mm	V liters	P kW	U V	Price net (€)
<b>435090</b>	570	350	285	8	0,76	230	<b>204,00</b>





# HOTEL LINE

INOX

- a line of highly-polished functional, elegant heaters of top quality and modern design
- they use innovative systems that facilitate operation:  
a hinged cover with a window and Roll-Top



### GN 1/1 HEATER

- opened cover 180°
- including: GN1/1 dish container and 2 fuel containers



Code	W mm	D mm	H mm	V liters	Price net (€)
<b>437010</b>	670	520	450	9	<b>273,00</b>

### WATER HEATER

- designed to heat water
- made of stainless steel
- 1 fuel container included



Code	W mm	D mm	H mm	V liters	Price net (€)
<b>431113</b>	320	330	570	13	<b>175,00</b>



**GN 1/1 ELECTRIC HEATER**

- tub made of heat-resistant plastics
- other elements made of stainless steel
- heater with thermostat
- included: GN 1/1 container 100 mm



Code	W mm	D mm	H mm	V liters	P kW	U V	Price net (€)
<b>435130</b>	620	480	300	13	2,0	230	<b>261,00</b>

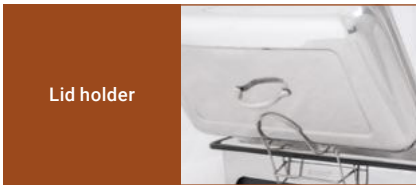

Lid holder



Control panel



Well fitted lid

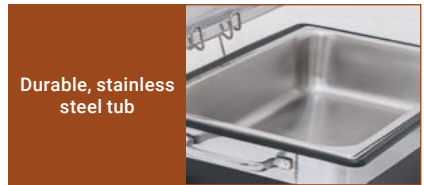

Durable, stainless steel tub

**ELECTRIC HEATER WITH SOUP KETTLES**

- tub made of heat-resistant plastics
- other elements made of stainless steel
- heater with thermostat
- complete with: 2 kettles, 2 lids, 2 spoons



Code	W mm	D mm	H mm	V liters	P kW	U V	Price net (€)
<b>433241</b>	620	480	310	2 x 4	2,0	230	<b>295,00</b>

## HEATING COMPONENT FOR HEATERS

- height adjustable automatically, max. 112 mm, min. 90 mm
- intended for heaters: 434090, 436110, 437041, 437011
- easy assembly and disassembly



## FUEL AND GEL CONTAINER

- fits all can heaters for fuel can code 430000 and for a can of gel code 430002



Assembly method



Code	H mm	Price net (€)
<b>430010</b>	60	<b>3,95</b>

Code	W mm	D mm	P kW	U V	Price net (€)
<b>430350</b>	110	160	0,35	230	<b>66,80</b>

## HEATING COMPONENT FOR HEATERS

- temperature 65 ÷ 90°C
- intended for heaters: 434090, 437041, 437011
- easy assembly and disassembly

Code	W mm	D mm	P kW	U V	Price net (€)
<b>430300</b>	250	200	0,25	230	<b>74,40</b>



## HEATING COMPONENT FOR HEATERS

- heater with symostat
- 5 heating levels
- temperature 45 ÷ 225°C
- intended for heaters: 434090, 437041, 437011
- easy assembly and disassembly

Code	W mm	D mm	P kW	U V	Price net (€)
<b>430401</b>	230	200	0,40	230	<b>51,00</b>
<b>430700</b>	250	200	0,70	230	<b>95,70</b>

Control knob



Easy installation for heaters



# ELECTRIC BOILERS FOR SOUPS

## ELECTRIC SOUP BOILER

- recommended for soups, creams and sauces
- fitted with a lid with a cutout for spoon
- housing made of matt steel
- heater with thermostat



capacity 5.7 l



Code	Ø mm	H mm	V liters	P kW	U V	Price net (€)
<b>432110</b>	280	340	5,7	0,3	230	<b>112,00</b>

## ELECTRIC SOUP BOILER

- recommended for soups, creams and sauces
- electronic control panel with temperature display
- temperature control 65-95°C with steps every 1°C
- fitted with a lid with a cutout for spoon
- housing made of matt steel



Control panel



Code	Product	Ø mm	H mm	V liters	P kW	U V	Price net (€)
<b>432115</b>	Soup boiler	395	340	9	0,4	230	<b>143,00</b>
<b>432190</b>	Cauldron batch - additional	245	255	10	-	-	<b>43,30</b>



**ELECTRIC SOUP BOILER**

- recommended for soups, creams and sauces
- fitted with a lid with a flap and cutout for spoon
- housing made of matt steel
- heater with thermostat

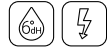

Even heating  
through a water  
jacket

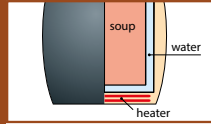

Code	Ø mm	H mm	V liters	P kW	U V	Price net (€)
<b>432100</b>	340	370	8,5	0,4	230	<b>130,00</b>

**ELECTRIC SOUP BOILER**

- soup container, lid and water container made of stainless steel
- lid with a cutout for spoon
- housing made of high impact plastic
- heater with thermostat
- spoon included

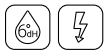

**SUNNEX®**

Soup container  
made of  
stainless steel



Code	Ø mm	H mm	V liters	P kW	U V	Price net (€)
<b>432101</b>	350	360	10	0,4	230	<b>210,00</b>

**WATER HEATER**

- designed to heat water
- made of stainless steel
- 1 fuel container included

Code	W mm	D mm	H mm	V liters	Price net (€)
<b>431113</b>	320	330	570	13	<b>175,00</b>



**COOKER**

- designed for heating or boiling water
- thermostat adjustment range from 30°C to 110°C
- cold handles made of plastic
- fluid level indicator
- safety thermostat
- „drip-free“ valve
- housing made of powder coated steel
- built-in heater
- power and operation indicator



No.	Code	Product	Ø mm	W mm	D mm	H mm	V liters	P kW	U V	Price net (€)
1.	<b>751087</b>	Cooker	225	-	-	495	8,7	1,5	230	<b>122,00</b>
	<b>751205</b>	Cooker	295	-	-	570	20,5	2,5	230	<b>151,00</b>
2.	<b>383300</b>	Drip tray	-	300	150	-	-	-	-	<b>22,70</b>

**GREDIL COOKER**

- device intended for heating or boiling water
- thermostat adjustment range from 30°C to 110°C
- non-heating plastic handles
- liquid level indicator in the tank
- safety thermostat
- drip-proof tap
- device made of highly polished stainless steel
- built-in heater
- power indicator light



No.	Code	Product	Ø mm	W mm	D mm	H mm	V liters	P kW	U V	Price net (€)
1.	<b>751105</b>	Cooker	280	-	-	487	10	1,5	230	<b>98,50</b>
	<b>751185</b>	Cooker	365	-	-	498	18	2,5	230	<b>115,00</b>
2.	<b>383300</b>	Drip tray	-	300	150	-	-	-	-	<b>22,70</b>



**COOKER**

- device intended for heating or boiling water
- thermostat adjustment range from 30°C to 110°C
- liquid level indicator in the tank
- safety thermostat
- drip-proof tap
- device made of highly polished stainless steel
- built-in heater
- power indicator light
- scale indicator light



No.	Code	Product	Ø mm	W mm	D mm	H mm	V liters	P kW	U V	Price net (€)
1.	<b>751102</b>	Cooker	225	-	-	460	10	2,4	230	<b>122,00</b>
	<b>751192</b>	Cooker	275	-	-	580	19	2,6	230	<b>162,00</b>
2.	<b>383300</b>	Drip tray	-	300	150	-	-	-	-	<b>22,70</b>

**DOUBLE-WALLED BOILER**

- device intended for heating or boiling water
- double walls provide up to 30% lower power consumption
- lower housing temperature (lower risk of burns)
- thermostat adjustment range from 30°C to 110°C
- beverage level indicator in the tank
- safety thermostat
- device made of highly polished stainless steel
- built-in heater
- power indicator light

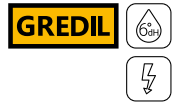

No.	Code	Product	Ø mm	W mm	D mm	H mm	V liters	P kW	U V	Price net (€)
1.	<b>751106</b>	Cooker	230	-	-	500	10	1,5	230	<b>113,00</b>
	<b>751186</b>	Cooker	290	-	-	498	18	2,5	230	<b>129,00</b>
2.	<b>383300</b>	Drip tray	-	300	150	-	-	-	-	<b>22,70</b>

**DOUBLE-WALLED BOILER**

- device intended for heating or boiling water
- double walls provide up to 30% lower power consumption
- lower housing temperature (lower risk of burns)
- thermostat adjustment range from 30°C to 110°C
- liquid level indicator in the tank
- safety thermostat
- removable drip tray and non-drip tap
- device made of highly polished stainless steel
- built-in heater
- power indicator light
- scale indicator light



Code	Ø mm	H mm	V liters	P kW	U V	Price net (€)
<b>751209</b>	241	480	9	2,4	230	<b>186,00</b>
<b>751220</b>	288	602	18	2,4	230	<b>212,00</b>



**BREWER**

- device for brewing tea, herbs, and heating water
- after the brewing process is finished, the appliance automatically switches to the hot beverage heating function
- beverage level indicator in the tank
- safety thermostat
- non-drip tap
- device made of highly polished stainless steel
- heating from 70°C to 80°C
- temperature indicator light
- power indicator light



Built-in heater

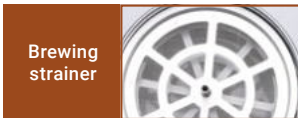

Brewing strainer

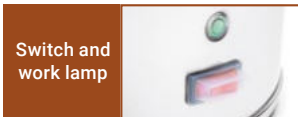

Switch and work lamp



No.	Code	Product	Ø mm	W mm	D mm	H mm	V liters	P kW	U V	Price net (€)
1.	<b>752120</b>	Brewer	270	-	-	530	12,0	1,35	230	<b>181,80</b>
2.	<b>383300</b>	Drip tray	-	300	150	-	-	-	-	<b>22,70</b>

**ELECTRIC KETTLE**

- made of polished stainless steel
- large lid for easy pouring
- water level indicator
- automatic switch
- overheating protection
- base enabling rotating the kettle by 360°
- power indicator light

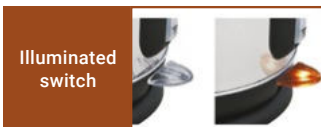

Illuminated switch



Rotation 360°



Code	W mm	D mm	H mm	V liters	M kg	P kW	U V	Price net (€)
<b>751900</b>	333	232	286	4,2	1,4	2	230	<b>38,33</b>

## CATERING THERMAL INSULATION CONTAINER

- perfect for hot and cold beverages
- housing made of stainless steel
- interior made of aluminum
- folding legs for easy storage

Screwed lid with handling grips



No.	Code	Product	Ø mm	H mm	V liters	Price net (€)
1.	<b>385951</b>	Vacuum flask	230	410	9,5	<b>59,30</b>
	<b>385140</b>	Vacuum flask	230	560	14,0	<b>89,70</b>
2.	<b>383140</b>	Drip tray	140	20	-	<b>5,48</b>



## TABLE VACUUM FLASK

- with pump
- steel insert
- polypropylene lid and handle



## TABLE VACUUM FLASK

- with pump
- steel insert
- polypropylene lid and handle



Opened lid with pump button lock



Opened lid with pump button lock



No.	Code	Product	Ø mm	H mm	V liters	Price net (€)
1.	<b>383250</b>	Vacuum flask	-	360	2,5	<b>33,50</b>
2.	<b>383140</b>	Drip tray	140	20	-	<b>5,48</b>

No.	Code	Product	Ø mm	H mm	V liters	Price net (€)
1.	<b>383400</b>	Vacuum flask	-	380	4,0	<b>43,20</b>
	<b>383500</b>	Vacuum flask	-	430	5,0	<b>48,30</b>
2.	<b>383140</b>	Drip tray	140	20	-	<b>5,48</b>

TABLE VACUUM FLASK

- with button
- steel insert
- polypropylene lid and handle



Code	V liters	Price net (€)
<b>382150</b>	1,5	<b>18,40</b>
<b>382200</b>	2,0	<b>19,60</b>

TABLE VACUUM FLASK

- perfect for hot and cold beverages
- stainless steel vacuum flask
- unscrewed lid made of polypropylene in black



Code	H mm	V liters	Price net (€)
<b>382151</b>	245	1,5	<b>20,60</b>
<b>382201</b>	285	2,0	<b>20,90</b>

TABLE VACUUM FLASK

- fitted with a lid with a flap
- steel insert



INOX

Code	H mm	V liters	Price net (€)
<b>386100</b>	235	1,00	<b>43,80</b>
<b>386150</b>	250	1,50	<b>43,40</b>
<b>386200</b>	295	2,00	<b>47,50</b>

PITCHER



INOX

Code	V liters	Price net (€)
<b>373051</b>	0,5	<b>9,90</b>
<b>373101</b>	1,0	<b>15,70</b>
<b>373151</b>	1,5	<b>21,40</b>
<b>373201</b>	1,9	<b>23,30</b>

PITCHER



INOX

Code	V liters	Price net (€)
<b>371200</b>	2,0	<b>25,60</b>

PITCHER

- for frothing milk



INOX

Code	V liters	Price net (€)
<b>372035</b>	0,35	<b>8,75</b>
<b>372060</b>	0,60	<b>12,00</b>
<b>372100</b>	1,00	<b>15,70</b>
<b>372150</b>	1,50	<b>22,10</b>
<b>372200</b>	2,00	<b>27,50</b>

**BEVERAGE DISPENSER**

- housing made of highly polished stainless steel
- liquid container made of polycarbonate
- removable drip grid
- ice container inside the dispenser



Code	W mm	D mm	H mm	V liters	Price net (€)
<b>468001</b>	265	350	560	8	<b>124,00</b>

**BEVERAGE DISPENSER**

- housing made of highly polished stainless steel
- liquid container made of polycarbonate
- ice container inside the dispenser



Code	W mm	D mm	H mm	V liters	Price net (€)
<b>468002</b>	220	280	510	5	<b>143,00</b>

**BREAKFAST CEREALS DISPENSER**

- housing made of highly polished stainless steel
- cereal dish made of plastic



Code	W mm	D mm	H mm	V liters	Price net (€)
<b>467001</b>	185	240	600	4	<b>116,00</b>

**BEVERAGE COOLING UNIT**

- efficient mixing system
- body made of stainless steel
- juice container made of durable polycarbonate
- low noise level at 55 dB
- drip tray included



Code	W mm	D mm	H mm	V liters	T °C	M kg	P kW	U V	Price net (€)
<b>469102</b>	430	430	632	2x12	+3 ~ +8	28	0,3	230	<b>1163,00</b>

**FROZEN BEVERAGE DISPENSER**

- appliance for preparing frozen beverages
- illuminated lid
- electronic temperature control
- high-performance compressor
- easy to keep clean
- containers can be illuminated (day/night mode)
- coolant: R290a
- drip tray included



Code	W mm	D mm	H mm	V liters	M kg	P kW	U V	Price net (€)
<b>469112</b>	470	510	810	2x12	62	0,9	230	<b>2900,00</b>

PLATTER

• edge 3 mm

INOX

Code	W mm	D mm	Price net (€)
401252	254	183	5,11
401302	302	202	6,83
401352	348	233	7,98
401402	392	262	11,30
401502	498	346	17,20



DISPLAY TRAY

• rectangular

INOX

Code	W mm	D mm	H mm	Price net (€)
406250	270	210	25	12,60
406280	300	235	25	15,50
406310	325	250	25	16,50
406340	355	275	25	21,70
406400	420	295	25	26,10
406460	580	365	25	35,40
406550	580	365	25	59,70



PLATTER UNDER THE PLATEX

• round

SUNNEX®

Code	Ø mm	Price net (€)
408301	300	20,60



LID

• fits tray 408301

Code	Ø mm	H mm	Price net (€)
409250	250	110	20,40

# WAITER TRAYS



## WAITER TRAY

- non-slip
- available in black and in three shapes: round, oval or rectangular

No.	Code	Ø mm	W mm	D mm	H mm	Price net (€)
1.	<b>412350</b>	355	-	-	25	<b>7,91</b>
	<b>412400</b>	405	-	-	25	<b>10,70</b>
2.	<b>415510</b>	-	510	635	25	<b>25,83</b>
	<b>415600</b>	-	600	735	25	<b>36,00</b>
3.	<b>411450</b>	-	405	305	-	<b>9,90</b>
	<b>411500</b>	-	460	360	-	<b>15,00</b>
	<b>411560</b>	-	510	380	-	<b>19,90</b>
	<b>411650</b>	-	650	450	-	<b>33,80</b>



## LAMINATED TRAY

- available in various shapes and sizes, including the popular GN 1/1
- the offer includes two colours: mahogany or birch
- non-slip coating except 414000 and 414020

No.	Code	Ø mm	W mm	D mm	H mm	Price net (€)
1.	<b>414000</b>	-	530	325	-	<b>17,81</b>
2.	<b>414020</b>	-	530	325	-	<b>19,00</b>
3.	<b>410550</b>	-	550	400	-	<b>21,15</b>



# TRAYS

## TRAY

- temperature range from -40 °C to +130 °C



No.	Code	W mm	D mm	H mm	Price net (€)
1.	<b>413370</b>	530	370	17	<b>18,00</b>
2.	<b>413460</b>	460	360	20	<b>14,90</b>
3.	<b>413530</b>	530	325	17	<b>17,60</b>



## TRAY

- anti-slip coating
- laminated
- temperature range from +80 °C to -10 °C, it cannot be scalded, but it is dishwasher safe



No.	Code	Ø mm	H mm	Price net (€)
4.	<b>414332</b>	330	15	<b>12,69</b>



## TRAY

- anti-slip coating
- laminated
- temperature range from +80 °C to -10 °C, it cannot be scalded, but it is dishwasher safe



No.	Code	W mm	D mm	H mm	Price net (€)
5.	<b>414371</b>	530	370	15	<b>21,90</b>
6.	<b>414373</b>	530	370	15	<b>19,71</b>



## TRAY

- anti-slip coating
- laminated
- temperature range from +80 °C to -10 °C, it cannot be scalded, but it is dishwasher safe



No.	Code	W mm	D mm	H mm	Price net (€)
7.	<b>414531</b>	530	325	15	<b>20,70</b>
8.	<b>414532</b>	530	325	15	<b>20,70</b>
9.	<b>414533</b>	530	325	15	<b>20,70</b>



TRAY

- granite available in sizes GN1/1 or trapezoidal shape
- polyester reinforced with fiberglass
- tray 413010, rubber coated



No.	Code	W mm	D mm	H mm	Price net (€)
1.	<b>413020</b>	477	337	15	<b>8,38</b>
2.	<b>413001</b>	530	325	-	<b>16,20</b>
3.	<b>413010</b>	530	325	-	<b>33,80</b>



TRAY

- available in various sizes including the popular GN1/1
- rounded edges
- resistant to discoloration



No.	Code	W mm	D mm	H mm	Price net (€)
1.	<b>413031</b>	530	325	-	<b>13,30</b>
2.	<b>413033</b>	456	356	-	<b>8,60</b>
3.	<b>413032</b>	415	305	-	<b>7,13</b>

WAITER TRAY

- rectangular
- polypropylene with handles



Code	W mm	D mm	H mm	Price net (€)
<b>414090</b>	430	305	30	<b>6,09</b>



## FAST FOOD TRAYS



- ideal for small and medium catering establishments
- available in 6 colors and most common sizes
- easy to keep clean



Code	Colour	W mm	D mm	Price net (€)
413251	Red	250	350	2,70
413252	Green	250	350	2,70
413253	Black	250	350	2,70
413254	Blue	250	350	2,84
413255	Grey	250	350	2,84
413256	Brown	250	350	2,84

Code	Colour	W mm	D mm	Price net (€)
413301	Red	300	400	3,57
413302	Green	300	400	3,57
413303	Black	300	400	3,57
413304	Blue	300	400	3,57
413305	Grey	300	400	3,57
413306	Brown	300	400	3,57

Code	Colour	W mm	D mm	Price net (€)
413351	Red	350	450	5,26
413353	Black	350	450	5,26
413354	Blue	350	450	5,26
413355	Grey	350	450	5,26
413356	Brown	350	450	6,02

### TRAY STAND

- foldable
- plastic feet protecting the floor from damage
- nylon straps supporting trays



Code	W mm	D mm	H mm	Price net (€)
415000	470	480	780	54,10

**SERVING CASE GN 1/1**

- complete with: 1 cooling insert, Roll-Top polycarbonate cover opening up to 90°, steel tray GN 1/1 20, black container made of polycarbonate GN 1/1 65
- polycarbonate lid can be purchased separately



Code	Product	W mm	D mm	H mm	Price net (€)
<b>419100</b>	Refrigerated display cabinet	530	325	240	<b>107,00</b>
<b>419112</b>	Cooling insert	235	119	31	<b>5,88</b>

## BUFFET COLUMNS

Buffet columns are an excellent solution for arranging breakfast and banquet buffets. Varied height of straight and angular columns, as well as rich assortment of shelves made of wood in two shades of brown, glass shelves and slate plates, allow the possibility of free arrangement in a small space, allowing you to create unique displays of served dishes and snacks. Ease of installation and disassembly and the lightweight design make the column systems ideal for elegant receptions, events and catering.

**SLATE PLATE**

Code	W mm	D mm	H mm	Price net (€)
<b>399101</b>	200	200	5	<b>3,67</b>
<b>399102</b>	200	100	5	<b>2,44</b>
<b>399103</b>	300	300	5	<b>6,87</b>
<b>399104</b>	300	200	5	<b>5,15</b>

**BUFFET COLUMN**

No.	Code	Colour	Description	W mm	D mm	H mm	Price net (€)
1.	<b>815601</b>	●	High	150	150	570	<b>110,00</b>
2.	<b>815621</b>	●	Low	150	150	355	<b>78,60</b>
3.	<b>815600</b>	●	High	150	150	570	<b>162,74</b>

**INOX**

## FINGER FOOD SLATE PLATE

- to serve snacks, dishes and desserts
- perfect for tastings and presentations
- made of natural stone with rough edges

### SLATE PLATE

- available in 4 GN sizes



Code	Description	W mm	D mm	H mm	K pcs	Price net (€)
<b>399111</b>	GN 1/1	530	325	5	1	<b>19,20</b>
<b>399112</b>	GN 1/2	325	265	5	1	<b>10,40</b>
<b>399113</b>	GN 1/3	325	175	5	1	<b>7,37</b>
<b>399114</b>	GN 1/4	265	160	5	1	<b>6,05</b>

### SLATE PLATE

- square



Code	W mm	D mm	H mm	K pcs	Price net (€)
<b>399101</b>	200	200	5	1	<b>3,67</b>
<b>399103</b>	300	300	5	1	<b>6,87</b>
<b>399117</b>	100	100	5	4	<b>5,07</b>

### SLATE PLATE

- round
- 399118 swivel base



Code	Ø mm	H mm	K pcs	Price net (€)
<b>399118</b>	300	5	1	<b>19,18</b>
<b>399119</b>	300	5	1	<b>7,60</b>
<b>399120</b>	330	5	1	<b>8,77</b>

### SLATE PLATE

- available in 2 GN sizes
- with handles



Code	Description	W mm	D mm	H mm	K pcs	Price net (€)
<b>399122</b>	GN 1/2	325	265	5	1	<b>9,87</b>

### SLATE PLATE

- rectangular



Code	W mm	D mm	H mm	K pcs	Price net (€)
<b>399102</b>	200	100	5	1	<b>2,44</b>
<b>399104</b>	300	200	5	1	<b>5,15</b>
<b>399115</b>	400	250	5	1	<b>9,18</b>
<b>399116</b>	400	120	5	1	<b>5,19</b>

### BUFFET BASE

- intended to display and serve snacks, dishes and desserts
- base made of acacia wood
- dedicated slate plate 399431 sold separately
- allows any configuration and product stacking



No.	Code	Product	W mm	D mm	H mm	Price net (€)
1.	<b>399430</b>	Base	420	320	55	<b>17,94</b>
2.	<b>399431</b>	Plate	400	300	7	<b>7,07</b>

# FINGER FOOD UTENSILS

## MINI DIP

• smooth steel

INOX



No.	Code	Ø mm	H mm	V liters	Price net (€)
1.	<b>546042</b>	67	30	0,06	<b>0,87</b>
2.	<b>546043</b>	72	48	0,12	<b>1,74</b>

## MINI DIP

• hammered steel

INOX



No.	Code	Ø mm	H mm	V liters	Price net (€)
1.	<b>546044</b>	57	45	0,075	<b>1,27</b>
2.	<b>546045</b>	72	48	0,120	<b>1,99</b>

## CUP FOR FRIES

INOX



Code	Ø mm	H mm	V liters	Price net (€)
<b>546022</b>	88	110	0,3	<b>6,58</b>

## MINI BUCKET

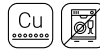

Code	Ø mm	H mm	V liters	Price net (€)
<b>546040</b>	120	120	0,90	<b>12,30</b>

## MINI BUCKET

• for serving snacks or side dishes

INOX



Code	Ø mm	H mm	V liters	Price net (€)
<b>546034</b>	95	95	0,400	<b>4,97</b>
<b>546035</b>	120	120	0,900	<b>6,60</b>

## CUP FOR FRIES

• 546025 hammered steel

INOX



No.	Code	Ø mm	H mm	V liters	Price net (€)
1.	<b>546024</b>	88	85	0,41	<b>4,15</b>
2.	<b>546025</b>	88	85	0,41	<b>5,07</b>

## FRENCH FRIES STAND



Code	Ø mm	H mm	Price net (€)
<b>319041</b>	100	150	<b>4,28</b>

**FINGER FOOD BASKET**

- for serving snacks or side dishes
- not suitable for contact with food; it is recommended to use paper (code 319010)



No.	Code	Ø mm	W mm	D mm	H mm	Price net (€)
1.	<b>546052</b>	80	-	-	65	<b>6,60</b>
2.	<b>546051</b>	-	100	80	70	<b>7,54</b>

**FINGER FOOD BASKET**

- for serving snacks or side dishes



No.	Code	W mm	D mm	H mm	Price net (€)
1.	<b>546061</b>	100	80	70	<b>8,82</b>
2.	<b>546064</b>	100	100	70	<b>7,80</b>

**FINGER FOOD BASKET**

- for serving snacks or side dishes



No.	Code	Ø mm	W mm	D mm	H mm	Price net (€)
1.	<b>546002</b>	80	-	-	80	<b>7,62</b>
2.	<b>546004</b>	-	103	92	72	<b>9,76</b>
3.	<b>546005</b>	-	105	90	60	<b>12,10</b>



**MINI COLANDER**

- for serving snacks or side dishes

INOX



Code	Ø mm	H mm	Price net (€)
<b>546021</b>	130	65	<b>7,21</b>

**FINGER FOOD SPOON**

INOX



Code	L mm	K pcs	Price net (€)
<b>357300</b>	143	12	<b>2,46</b>

**MINI SAUCEPAN**

INOX



No.	Code	Ø mm	H mm	V liters	Price net (€)
1.	<b>546009</b>	68	43	0,13	<b>7,96</b>
2.	<b>546010</b>	110	60	0,38	<b>13,80</b>

**MUG**

- smooth and durable surface
- lasting color
- heat resistant



Code	Ø mm	H mm	V liters*	Price net (€)
<b>547010</b>	80	80	0,400	<b>4,53</b>

**SERVING ACCESSORIES**

- professional set of serving accessories
- made of high-polished stainless steel with monoblock technology
- no welds and bends, made of one piece of steel
- easy to keep clean
- handle thickness 2.7 mm



No.	Code	Product	L mm	V liters	Price net (€)
1.	<b>420012</b>	Perforated spoon	310	-	<b>7,16</b>
2.	<b>420032</b>	Serving spoon	315	-	<b>7,80</b>



**MENU HOLDER**

Code	H mm	Price net (€)
<b>486031</b>	102	<b>2,28</b>



# CATERING

Appliances and accessories necessary to handle external events. Versatile, lightweight and durable catering equipment. Heating lamps that are a great solution for any space requiring maintaining a stable and comfortable temperature.

Heating lamps.....	195
Hanging heating lamps .....	196
Heating table.....	196
Pyramid heating lamp .....	197

Catering furniture .....	198
Covers for catering furniture .....	199
Hotel poles .....	199

## HANGING HEATING LAMPS

- intended for heating, e.g.: restaurant gardens, tents, umbrellas
- halogen lamp with a lifetime of approx. 5000h
- protection rating - IP44

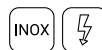

1



2



3

Umbrella with  
a mounted  
heating system



Remote control  
included in  
model 692310  
as standard



Folded lamp



## 1 HANGING HEATING LAMP

- remote control (remote)
- built-in LED lighting
- 3 power levels

Code	Ø mm	H mm	M kg	P kW	U V	Price net (€)
<b>692310</b>	585	300	3,2	2,1	230	<b>183,52</b>

## 2 HANGING HEATING LAMP

- 3 power levels

Code	Ø mm	H mm	M kg	P kW	U V	Price net (€)
<b>692311</b>	530	300	2,0	1,8	230	<b>142,32</b>

## 3 SUSPENDED HEATING LAMP FOR THE UMBRELLA

- suspended umbrella heating system
- allows installing an umbrella with a diameter of 30-65 mm on each leg
- unique design increases the area of effect
- allows folding the umbrella with the heating system installed
- 3 power levels

Code	Ø mm	H mm	M kg	P kW	U V	Price net (€)
<b>692312</b>	1000	850	3,6	2,0	230	<b>164,50</b>

HEATING LAMPS

- halogen lamp with a lifetime of approx. 5000h
- protection rating - IP44



1 HEATING LAMP

- can be mounted on the wall as well as hanging from the ceiling
- 1 power level

2 HEATING LAMP

- can be mounted on the wall as well as hanging from the ceiling
- remote control (remote)
- 2 power levels

Code	W mm	D mm	H mm	M kg	P kW	U V	Price net (€)
692321	455	90	100	1,5	1,5	230	134,02

Code	W mm	D mm	H mm	M kg	P kW	U V	Price net (€)
692322	1050	90	100	2,4	3,0	230	301,30

HEATING TABLE

- bar table with heating function
- a red mesh-covered filament
- halogen lamp with a lifetime of approx. 5000h
- protection rating - IP44

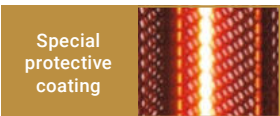

Code	Ø mm	H mm	M kg	P kW	U V	Price net (€)
692333	600	1100	17,5	1,5	230	334,38

## PYRAMID HEATING LAMP

- base housing made of stainless steel
- connection elements made of aluminium
- tube made of tempered glass, which gives a nice visual effect and even distribution of heat
- security system cutting off gas supply at moment of fall over the radiator
- electric spark generator, powered with batteries (AAA)
- gas usage 945g/h
- gas bottle to be connected in base housing
- control panel installed in heating module
- easy and simple assembly
- cover as option - code 693211



No.	Code	W mm	L mm	H mm	P kW	U V	Price net (€)
1.	<b>693210</b>	520	-	2270	13	G30	<b>492,00</b>
2.	<b>693211</b>	-	2270	-	-	-	<b>34,00</b>

## HEATING LAMP

- housing made of powder coated steel
- piezoelectric fuse
- steering by knob
- umbrella of lamp effectively and even distributes heat and secures burners
- gas bottle to be put in base housing
- mounting kit included to attach the lamp to the ground
- gas usage 945g/h
- easy and simple assembly
- cover as option - code 693226



No.	Code	Ø mm	L mm	H mm	P kW	U V	Price net (€)
3.	<b>693225</b>	460	-	2210	13	G30	<b>220,00</b>
4.	<b>693226</b>	-	2210	-	-	-	<b>30,00</b>

# CATERING FURNITURE

PE

- folded furniture
- can be used both indoors and outdoors
- easy to store and transport
- painted steel elements



## 1 CATERING TABLE

- table dimensions after folding (WxDxH): 1220x610x50 mm

Code	W mm	D mm	H mm	M kg	Price net (€)
<b>950112</b>	1220	610	740	8,9	<b>81,30</b>

## 2 CATERING TABLE

- table dimensions after folding (WxDxH): 920x750x95 mm

Code	W mm	D mm	H mm	M kg	Price net (€)
<b>950118</b>	1830	760	740	13,7	<b>114,00</b>

## 3 ROUND CATERING TABLE

- table dimensions after folding (ØxH): 1150x50 mm

Code	Ø mm	H mm	M kg	Price net (€)
<b>950131</b>	1150	740	13,6	<b>110,00</b>

## 4 CATERING CHAIR

- chair dimensions after folding (WxDxH): 465x210x1150 mm

Code	W mm	D mm	H mm	M kg	Price net (€)
<b>950121</b>	475	530	870	4,5	<b>51,80</b>

## 5 CATERING BENCH

- bench dimensions after folding (WxDxH): 910x250x95 mm

Code	W mm	D mm	H mm	M kg	Price net (€)
<b>950120</b>	1830	280	430	8,8	<b>76,50</b>

## 6 BAR TABLE

Code	Ø mm	H mm	M kg	Price net (€)
<b>950141</b>	800	1100	9,3	<b>83,60</b>

### COVERS FOR CATERING FURNITURE

- covers for catering tables and chairs made of very flexible material
- 5% elastane, 95% polyeseter
- recommended for banquet halls, restaurants, catering and gastronomic gardens
- available in two most popular colors
- cover can be washed in room temperature

No.	Code	Description	Colour	Price net (€)
1.	<b>950160</b>	950141 table cover	○	<b>15,10</b>
	<b>950163</b>	950141 table cover	●	<b>15,10</b>
2.	<b>950167</b>	950131 table cover	●	<b>19,82</b>
	<b>950172</b>	950112 table cover	○	<b>13,90</b>
3.	<b>950175</b>	950112 table cover	●	<b>13,50</b>
	<b>950176</b>	950118 table cover	○	<b>15,70</b>
4.	<b>950179</b>	950118 table cover	●	<b>15,70</b>
	<b>950168</b>	950121 chair cover	○	<b>10,40</b>
	<b>950171</b>	950121 chair cover	●	<b>10,10</b>



#### 1 HOTEL POLE

- extendable tape
- red tape
- price per piece

Code	Ø mm	H mm	K pcs	Price net (€)
<b>689010</b>	310	965	2	<b>57,80</b>

#### 2 HOTEL POLE

- black colour
- pull-out tape
- price per piece

Code	Ø mm	H mm	K pcs	Price net (€)
<b>689011</b>	320	900	2	<b>51,50</b>

#### 3 HOTEL POLE

- sold without rope

Code	Ø mm	H mm	Price net (€)
<b>689001</b>	310	910	<b>51,40</b>

#### 4 BARRIER POLE ROPE

- for pole 689001

Code	Colour	L mm	Price net (€)
<b>689002</b>	●	1500	<b>13,00</b>
<b>689003</b>	●	1500	<b>13,00</b>







## BAR EQUIPMENT

Wide range of accessories, blenders and bar coolers essential in preparing great drinks or cocktails.

Blenders.....201-202  
Cocktail shakers, bartender's openers,  
mortar, bartender strainers..... 204-205  
Measuring cups,  
bartender spoons..... 205-206  
Coolers, champagne buckets,

**BAR BLENDER**

- designed to make cocktails or drinks with crushed ice
- rotation stepless adjustment
- stainless steel cutting blades
- automatic stop when the jar is removed
- temporarily increased speed during operation, if needed, with the "pulse" button
- lid with a hole
- metal drive coupling
- pusher included

**1**

**2**
**3**

No.	Code	Product	W mm	D mm	H mm	V liters	N rpm	P kW	U V	Price net (€)
1.	<b>484416</b>	Blender	195	230	490	2,00	28000	1,6	230	<b>171,40</b>
2.	<b>484016</b>	Jar	-	-	-	1,60	-	-	-	<b>51,20</b>
3.	<b>484020</b>	Jar	-	-	-	2,00	-	-	-	<b>51,20</b>

**1**

**2**
**3**

No.	Code	Product	W mm	D mm	H mm	V liters	N rpm	P kW	U V	Price net (€)
1.	<b>484419</b>	Blender	200	240	490	2,00	32000	2,0	230	<b>223,00</b>
2.	<b>484016</b>	Jar	-	-	-	1,60	-	-	-	<b>51,20</b>
3.	<b>484020</b>	Jar	-	-	-	2,00	-	-	-	<b>51,20</b>

**BAR BLENDER**

- designed to make cocktails or drinks with crushed ice
- rotation stepless adjustment
- stainless steel cutting blades
- automatic stop when the jar is removed
- built-in 1-5 minute timer
- 3 dedicated operating programs
- lid with a hole
- metal drive coupling
- pusher included



1



metal clutch



2

3



No.	Code	Product	W mm	D mm	H mm	V liters	N rpm	P kW	U V	Price net (€)
1.	<b>484421</b>	Blender	200	220	490	2,00	32000	2,0	230	<b>291,70</b>
2.	<b>484016</b>	Jar	-	-	-	1,60	-	-	-	<b>51,20</b>
3.	<b>484020</b>	Jar	-	-	-	2,00	-	-	-	<b>51,20</b>

CORK WITH TUBE

- price per item



No.	Code	L mm	K pcs	Price net (€)
1.	<b>475975</b>	65	12	<b>0,42</b>
2.	<b>475980</b>	103	1	<b>2,00</b>

CHAMPAGNE CORK



Code	Ø mm	H mm	Price net (€)
<b>472030</b>	35	55	<b>5,52</b>

LEMON SQUEEZER

- made of painted aluminum

Al



Code	Ø mm	L mm	Price net (€)
<b>474000</b>	55	208	<b>10,20</b>

CITRUS PLASTER SQUEEZER

INOX



Code	W mm	H mm	Price net (€)
<b>473021</b>	75	80	<b>1,36</b>

CITRUS SQUEEZER

INOX



Code	Ø mm	H mm	V liters	Price net (€)
<b>473000</b>	130	100	0,35	<b>18,00</b>

## BAR EQUIPMENT



1



2



3



4



5

### BARTENDER STRAINER

No.	Code	L mm	Price net (€)
1.	472090	130	3,37

### OPENER

No.	Code	L mm	Price net (€)
2.	472100	127	2,31

### WAITER'S CORKSCREW

No.	Code	L mm	Price net (€)
3.	472999	120	3,90
4.	472140	110	3,07

### MORTAR

- for fruit
- made of ABS plastic

No.	Code	L mm	Price net (€)
5.	472200	210	3,71

BOSTON SHAKER

No.	Code	Colour	Ø mm	H mm	V liters	Price net (€)
1.	<b>476002</b>	Orange	90	180	0,9	<b>4,91</b>
2.	<b>476000</b>	Grey	90	180	0,9	<b>5,30</b>



1



2

COCKTAIL SHAKER

• 3-part

No.	Code	V liters	Price net (€)
1.	<b>476070</b>	0,7	<b>22,60</b>
2.	<b>476051</b>	0,5	<b>10,10</b>
	<b>476071</b>	0,7	<b>11,30</b>



1



2



3

STEEL MUG FOR SHAKER

No.	Code	H mm	V liters	Price net (€)
3.	<b>472014</b>	130	0,53	<b>4,71</b>

DOUBLE-SIDED SCALE

• made of 18/8 steel



Code	V liters	Price net (€)
<b>474301</b>	0,020-0,040	<b>2,32</b>
<b>474302</b>	0,025-0,050	<b>2,68</b>

SCALE



Code	V liters	Price net (€)
<b>474101</b>	0,10	<b>3,35</b>

SCALE



Code	V liters	Price net (€)
<b>474251</b>	0,25	<b>5,70</b>

BAR SPOON

- model 472012 packed by 12 pcs.
- price per item



No.	Code	L mm	K pcs	Price net (€)
1.	<b>472010</b>	200	1	<b>5,16</b>
2.	<b>472011</b>	285	1	<b>3,86</b>
3.	<b>472012</b>	202	12	<b>0,88</b>
4.	<b>472020</b>	210	1	<b>4,49</b>
5.	<b>472013</b>	280	1	<b>1,71</b>



CUTTING BOARD

- non-slip coating on the board edges
- temp. resistance up to +90°C

Code	W mm	D mm	H mm	Price net (€)
<b>340270</b>	270	190	9	<b>6,92</b>
<b>340351</b>	350	250	10	<b>13,40</b>



PEELING KNIFE

Code	L mm*	Price net (€)
<b>285092</b>	100	<b>2,15</b>



**BARTENDER MAT**

- practical pads made of durable plastic
- clean with a damp cloth or rinse under running water, dry



No.	Code	W mm	D mm	H mm	Price net (€)
1.	<b>473900</b>	590	80	16	<b>8,93</b>
2.	<b>473910</b>	450	300	10	<b>16,10</b>

**BARTENDER'S ASSISTANT**

- napkin container 150x150 mm



Code	W mm	D mm	H mm	Price net (€)
<b>477100</b>	240	150	105	<b>7,64</b>

**BARTENDER CONTAINER**

- 5-part



Code	W mm	D mm	H mm	Price net (€)
<b>473500</b>	500	160	90	<b>23,20</b>

**BOTTLE CONTAINER**

- wall-mounted bar container for bottles



Code	W mm	D mm	H mm	Price net (€)
<b>474310</b>	550	100	150	<b>35,00</b>

**BARTENDER CONTAINER**



Code	Ø mm	H mm	Price net (€)
<b>815025</b>	120	140	<b>9,02</b>



CHAMPAGNE BUCKET

Code	Ø mm	H mm	V liters	Price net (€)
<b>477771</b>	210	205	4,5	<b>17,30</b>



CHAMPAGNE BUCKET

Code	Ø mm	H mm	V liters	Price net (€)
<b>477351</b>	200	205	4,5	<b>16,70</b>



THERMAL INSULATION  
CONTAINER FOR WINE



Code	V liters	Price net (€)
<b>477201</b>	1,9	<b>19,40</b>



BUCKET BASE

Code	H mm	Price net (€)
<b>478610</b>	600	<b>54,30</b>



BUCKET BASE

Code	H mm	Price net (€)
<b>478680</b>	680	<b>64,20</b>



THERMAL INSULATION  
CONTAINER FOR ICE



- drip tray and ice tongs included

Code	Ø mm	H mm	V liters	Price net (€)
<b>479200</b>	150	220	2	<b>51,00</b>

**SODA SIPHON**

- used to prepare soda and sparkling flavored drinks
- pressure control valve for maximum comfort and safety
- practical dispenser
- internal gauge to prevent overfilling
- dedicated cartridges - Code 500020

Code	V liters	Price net (€)
<b>500521</b>	1	<b>80,64</b>



**SODA SIPHON CARTRIDGES**

- each cartridge contains 8 g of pure CO<sub>2</sub>
- cartridges made of high-quality steel
- cartridges can be used in all siphons available in the market

Code	K pcs	Price net (€)
<b>500020</b>	10	<b>4,74</b>



**GUIDE RAILS FOR HANGING GLASSES**

- model 478020 - 2 rows
- model 478030 - 3 rows
- model 478050 - 5 rows



Code	W mm (front)	W mm (back)	D mm	H mm	Price net (€)
<b>478020</b>	200	160	355	70	<b>7,19</b>
<b>478030</b>	295	255	355	70	<b>10,60</b>
<b>478050</b>	480	450	355	70	<b>20,30</b>

**CITRUS SQUEEZER**

- fruit sieve Ø=120 mm



Code	W mm	D mm	H mm	Price net (€)
<b>473012</b>	185	225	710	<b>73,90</b>

**CITRUS SQUEEZER**

- device operated by a presser lever
- parts in contact with food are made of stainless steel
- speed 1450 rpm

The container, presser and squeezer are made of stainless steel



Code	W mm	D mm	H mm	P kW	U V	Price net (€)
<b>480021</b>	212	287	396	0,23	230	<b>325,00</b>

**ELECTRIC CITRUS SQUEEZER**

- open design
- 2 replaceable squeezing tips
- base made of anodized aluminum
- bowl and sieve made of polycarbonate
- transparent bowl lid
- the appliance is intended for continuous operation
- speed 900 rpm

2 squeezing tips included



Code	W mm	D mm	H mm	M kg	P kW	U V	Price net (€)
<b>480012</b>	315	200	440	5,7	0,18	230	<b>207,00</b>

**ELECTRIC ICE CRUSHER**

- cutting blades and roller made of stainless steel
- large batch opening
- dedicated container for crushed ice GN 1/6 150 mm

INOX

**NEW**



Code	W mm	D mm	H mm	S kg/h	M kg	P kW	U V	Price net (€)
<b>471160</b>	175	270	490	90	9	0,25	230	<b>328,46</b>

**ICE DISPENSER**

- used to produce crushed ice
- dedicated to bars, nightclubs, hotels, and fishmonger's shops
- high capacity up to 90 kg/24 h
- insulated 5 kg ice container
- compatible with a 3/4-inch water connection
- gravity drain
- air-cooled
- refrigerant R290
- AISI304 stainless steel housing



Code	W mm	D mm	H mm	M kg	P kW	U V	Price net (€)
<b>873550</b>	396	708	871	61	0,44	230	<b>6773,00</b>

**ICE CRUSHER**

- plastic container and drawer

Stainless steel knives



Code	W mm	D mm	H mm	Price net (€)
<b>471000</b>	160	135	270	<b>52,90</b>



ICE MACHINE

- auxiliary ice-maker
- manual water refilling
- electronic control panel
- performance up to 12 kg per day
- ice tank 1 kg
- air-cooled
- retains ice for up to 4 hours
- housing made of durable plastic



Block pattern



Code	W mm	D mm	H mm	P kW	U V	Price net (€)
871101	305	380	380	0,13	230	318,00

CRUSHED ICE MACHINE



- designed for clubs, bars, fast food chains, hotels, fish stores, etc.
- makes crushed ice (91% dry ice cubes)
- high efficiency 1l of water = 1 kg of ice
- high performance up to 55kg/24h
- has an ice tray (vol. 10 kg)
- ASI304 SS housing
- insulated walls
- required water connection
- gravity drain

Code	Performance kg/24h (~cubes)	Container capacity kg	Water consumption liters/kg	W mm	D mm	H mm	M kg	P kW	U V	Price net (€)
873551	55	10	1	450	620	680	56	0,42	230	3749,00

# FREE-STANDING ICE CUBE MACHINES

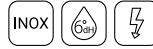

- designed for hotels, restaurants, clubs and fast food bars
- air-cooled (**recommended cooling system when installing the machine as a free-standing unit**)
- **lower water consumption compared to water-cooled models**
- formation of cubes by spraying
- has an ice container (capacity is given in the technical data table)
- insulated walls
- required water connection and drain
- gravity drain
- ABS housing in model 872211

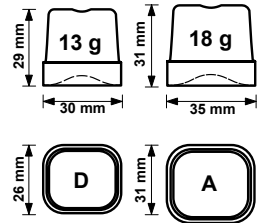

No.	Code	Performance kg/24h (~cubes)	Container capacity kg (~cubes)	Block type	W mm	D mm	H mm	Water consumption liters/kg	P kW	U V	Price net (€)
1.	<b>872211</b>	up to 21 kg/24 h (~1690)	4 (~310)	D	355	404	590	4,5	0,32	230	<b>1349,00</b>
2.	<b>872213</b>	up to 21 kg/24 h (~1690)	4 (~310)	D	355	404	590	4,5	0,32	230	<b>1453,00</b>
3.	<b>872281</b>	up to 29 kg/24 h (~1610)	9 (~530)	A	390	460	690	5,1	0,37	230	<b>1683,00</b>
4.	<b>872331</b>	up to 38 kg/24 h (~1940)	16 (~950)	A	500	580	800	3,3	0,37	230	<b>1984,00</b>
	<b>872421</b>	up to 42 kg/24 h (~2440)	16 (~950)	A	500	580	800	4,0	0,45	230	<b>2060,00</b>
5.	<b>872461</b>	up to 48 kg/24 h (~2610)	25 (~1470)	A	500	580	910	4,0	0,50	230	<b>2209,00</b>
6.	<b>872651</b>	up to 72 kg/24 h (~3720)	40 (~2350)	A	738	600	1030	2,8	0,65	230	<b>2933,00</b>
	<b>872801</b>	up to 80 kg/24 h (~4720)	40 (~2350)	A	738	600	1030	2,6	0,80	230	<b>3169,00</b>
	<b>872901</b>	up to 95 kg/24 h (~5270)	55 (~3240)	A	738	600	1130	2,5	0,85	230	<b>3344,00</b>



# ICE CUBE MACHINES INTENDED FOR BUILT- IN INSTALLATION

- designed for hotels, restaurants, clubs and fast food bars.
- water-cooled (**recommended cooling system when installing the machine as a built-in unit, e.g. in a bar under the counter**)
- **quieter work and less heat generation**
- formation of cubes by spraying
- has an ice container (capacity is given in the technical data table)
- insulated walls
- required water connection and drain
- gravity drain
- ABS housing in model 872211

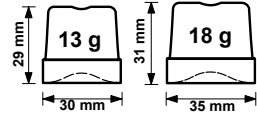

4

up to 48 kg/24h



6

up to 95 kg/24h

No.	Code	Performance kg/24h (~cubes)	Container capacity kg (~cubes)	Block type	W mm	D mm	H mm	Water consumption liters/kg	P kW	U V	Price net (€)
1.	<b>872212</b>	up to 21 kg/24 h (~1690)	4 (~310)	D	355	404	590	20,0	0,32	230	<b>1373,00</b>
2.	<b>872214</b>	up to 21 kg/24 h (~1690)	4 (~310)	D	355	404	590	20,0	0,32	230	<b>1505,00</b>
3.	<b>872282</b>	up to 29 kg/24 h (~1610)	9 (~530)	A	390	460	690	14,0	0,37	230	<b>1747,00</b>
4.	<b>872332</b>	up to 38 kg/24 h (~1940)	16 (~950)	A	500	580	800	13,0	0,37	230	<b>2002,00</b>
	<b>872422</b>	up to 42 kg/24 h (~2440)	16 (~950)	A	500	580	800	15,0	0,45	230	<b>2136,00</b>
5.	<b>872462</b>	up to 48 kg/24 h (~2610)	25 (~1470)	A	500	580	910	14,0	0,50	230	<b>2249,00</b>
6.	<b>872652</b>	up to 72 kg/24 h (~3720)	40 (~2350)	A	738	600	1030	12,8	0,65	230	<b>2986,00</b>
	<b>872802</b>	up to 80 kg/24 h (~4720)	40 (~2350)	A	738	600	1030	14,4	0,80	230	<b>3224,00</b>
	<b>872902</b>	up to 95 kg/24 h (~5270)	55 (~3240)	A	738	600	1130	14,2	0,85	230	<b>3461,00</b>



up to 26 kg/24h

**ICE MACHINE**

- designed for hotels, restaurants and fast food bars
- formation of cubes by immersion
- has an ice tray
- insulated walls
- required water connection and gravity drain



Block pattern

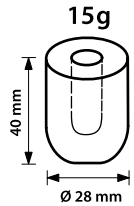

Code	Performance kg/24h (~cubes)	Container capacity kg (~cubes)	W mm	D mm	H mm	P kW	U V	Price net (€)
<b>871120</b>	do 20 (~1330)	4 (~265)	380	477	590	0,17	230	<b>692,00</b>
<b>871126</b>	do 26 (~1730)	6 (~400)	420	528	655	0,22	230	<b>749,00</b>

**ICE FLAKE MAKER**

- designed for hotels, restaurants, clubs, fast food bars, supermarkets, fish stores, industry and even medical points
- has an ice container (capacity is given in the technical data table)
- insulated walls
- required water connection and drain
- gravity drain



Flake pattern



1

up to 113 kg/24h



2

up to 153 kg/24h

No.	Code	Cooling	Performance kg/24h (~flakes)	V kg	W mm	D mm	H mm	Water consumption liters/kg	P kW	U V	Price net (€)
1.	<b>873901</b>	Air	do 113	20	500	660	800	1,0	0,55	230	<b>3850,00</b>
	<b>873902</b>	Water	do 113	20	500	660	800	6,3	0,55	230	<b>3850,00</b>
2.	<b>873151</b>	Air	do 153	40	738	690	1030	1,0	0,65	230	<b>4680,00</b>

REFRIGERATED BOTTLE DISPLAY CABINET



- powder coated housing (black)
- lighting
- forced air circulation
- electronic controller with display
- temperature
- automatic defrosting
- automatic condensate evaporation
- self-closing door with open door lock
- additional shelves and accessories p. 488



882161 sliding doors



Code	Description	W mm	D mm	H mm	V liters	T °C	P kW	U V	Energy class	Energy consumption kWh/year	Price net (€)
882151	1-door (opened)	600	530	870	129	+2/+8	0,105	230	B	627	735,00

REFRIGERATED BOTTLE DISPLAY CABINET



- powder coated housing (black)
- lighting
- forced air circulation
- electronic controller with temperature display
- automatic defrosting
- automatic condensate evaporation
- self-closing door with open door lock
- 882171: 8 shelves included
- additional shelf for: 880171 - Code 840653
- additional shelves and accessories p. 488



882171 sliding doors



Code	Description	W mm	D mm	H mm	V liters	T °C	P kW	U V	Energy class	Energy consumption kWh/year	Price net (€)
882171	2-doors (sliding)	920	514	1872	490	+2/+8	0,4	230	C	1765	1897,00



# CAFE EQUIPMENT

Professional coffee makers will allow you to prepare all types of aromatic coffees. These accessories will allow decorating and serving cakes and desserts impressively.

Coffee grinder .....	218	Coffee maker table .....	220
Drip coffee maker .....	219	Pitcher, tamper, coffee grounds striker, spice dispenser .....	221-222
Refrigerator for coffee milk .....	219		

## COFFEE GRINDERS



- coffee grinders are designed to grind roasted coffee beans and dose them
- the presented offer will be perfect for any type of restaurant serving coffee
- Each Barista will be satisfied with the possibility of precise adjustment of the grinding thickness of the beans
- professional grinder works great with filter coffee machines and portafilter coffee machines without a grinder



### 1 COFFEE GRINDER

- adjustable coffee grinding thickness
- adjustable coffee dose 5-12 g
- integrated coffee tamper
- easy to keep clean
- ABS housing



Code	W mm	D mm	H mm	V liters	P kW	U V	Price net (€)
<b>486500</b>	170	340	430	0,5	0,27	230	<b>505,00</b>

### 2 COFFEE GRINDER

- automatic
- adjustable coffee grinding thickness
- 2 electronically controlled coffee doses
- 3 grinding modes (1 serving, 2 servings, continuous)
- coffee count
- ABS housing



Code	W mm	D mm	H mm	V liters	P kW	U V	Price net (€)
<b>486502</b>	170	340	410	0,5	0,27	230	<b>633,00</b>

### 3 COFFEE GRINDER WITH HOPPER, ICONIC

- adjustable grinding thickness
- coffee portion adjustment in the range of: 5 - 12 g
- Integrated coffee tamper
- easy to clean
- ABS housing



Code	W mm	D mm	H mm	V liters	P kW	U V	Price net (€)
<b>486503</b>	170	340	430	0,5	0,27	230	<b>877,00</b>

### 4 AUTOMATIC COFFEE GRINDER WITH DISPLAY

- adjustable grinding thickness
- electronic coffee portion adjustment
- 3 coffee grinding modes:  
(1 portion, 2 portions, continuous operation)
- count of coffees made
- ABS housing
- easy to keep clean



Code	W mm	D mm	H mm	V liters	P kW	U V	Price net (€)
<b>486504</b>	170	340	410	0,5	0,27	230	<b>987,00</b>



**DRIP COFFEE MAKER**

- max. water tank volume 1.8 l
- 1.6-liter coffee pot
- has a work controls
- upper hob
- glass pitcher included
- set of 10 filters included
- housing made of stainless steel with black plastic elements
- non-slip feet



Code	W mm	D mm	H mm	V liters	P kW	U V	Price net (€)
<b>752286</b>	205	385	455	1,6	2,02	230	<b>205,35</b>

**CLEANING LIQUID FOR MILK FROTHING SYSTEMS**

- designed for daily maintenance of the appliance
- removes milk deposits (fat and protein residues)
- can be used to clean the appliance's outer surfaces
- does not affect the product' flavor and smell
- has a descaling effect



Code	V liters	Price net (€)
<b>648200</b>	1	<b>5,49</b>

**REFRIGERATOR FOR COFFEE MILK**

- top-quality compressor milk fridge
- dedicated to automatic coffee makers
- double glazed door
- milk hose holes on both sides
- compartment lighting
- forced air circulation

Compatible with most coffee machines



Code	W mm	D mm	H mm	V liters	T °C	M kg	P kW	U V	Price net (€)
<b>844100</b>	220	512	376	8,1	0~4	21	0,06	230	<b>331,00</b>



**COFFEE MAKER TABLE**

- tilting drawer with a brake and a coffee grounds striker
- cupboard for water softening filter
- utensil drawer
- a hole in the tabletop for connecting the coffee machine

INOX

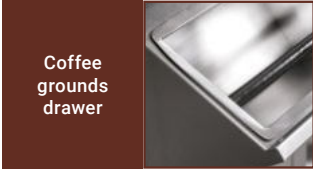

Coffee grounds drawer



Code	W mm	D mm	H mm	Price net (€)
<b>486700</b>	1000	700	1000	<b>715,00</b>

**COFFEE MAKER TABLE\***

- tilting drawer with a brake and a coffee grounds striker
- sink with a removable drip tray
- cupboard for water softening filter
- utensil drawer
- a hole in the tabletop for connecting the coffee machine

INOX



Code	W mm	D mm	H mm	Price net (€)
<b>486710</b>	1500	700	1000	<b>845,00</b>

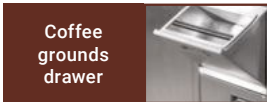

Coffee grounds drawer

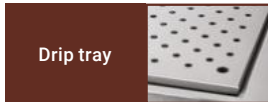

Drip tray



Sink compartment





SPICE DISPENSER

INOX



No.	Code	Description	Ø mm	H mm	V liters	Price net (€)
1.	<b>363200</b>	For cinnamon	70	130	0,4	<b>9,20</b>
2.	<b>363300</b>	For chocolate	70	130	0,4	<b>9,86</b>
3.	<b>363150</b>	For powdered sugar	70	130	0,4	<b>9,66</b>

CUP

- smooth and durable surface
- lasting color
- heat resistant
- enameled



PITCHER

- for frothing milk

INOX



Code	Ø mm	H mm	V liters*	Price net (€)
<b>547010</b>	76-69	146	0,225	<b>4,53</b>



Code	V liters	Price net (€)
<b>372035</b>	0,35	<b>8,75</b>
<b>372060</b>	0,60	<b>12,00</b>
<b>372100</b>	1,00	<b>15,70</b>
<b>372150</b>	1,50	<b>22,10</b>
<b>372200</b>	2,00	<b>27,50</b>

**AUXILIARY SCALE**



- battery power supply (3 AA batteries included) or via the mains power supply (optional - power supply not included)
- working time on battery 300 hours
- measurement stabilization time approx. 2 seconds
- measuring range: g, lb, oz, ozt, dwt
- model 730011 used in the kitchen as a precision scale, portable dedicated to cafes (weighing coffee, etc.), confectioneries (e.g. brewing spices)
- integrated transport lock
- ABS case



Code	W mm	D mm	H mm	M kg	Scope kg	Precision g	Price net (€)
<b>730011</b>	140	205	41	0,4	0,62	0,1	<b>83,50</b>
<b>730012</b>	140	205	41	0,4	2,2	1	<b>65,60</b>

**COFFEE GROUNDS STRIKER**

- striker for used coffee size GN 1/4



Code	W mm	D mm	H mm	Price net (€)
<b>486014</b>	265	162	102	<b>15,40</b>

**TAMPER**



Code	Ø mm	H mm	M kg	Price net (€)
<b>486012</b>	57	94	0,4	<b>34,50</b>

**COFFEE GRINDER OR COFFEE MAKER KNOCK OUT DRAWER**

- easy-to-clean, removable rubber ø 35 mm knock-out bar
- inner drawer dimensions: 250x320x70 mm
- non-slip feet for stable operation



No.	Code	W mm	D mm	H mm	Price net (€)
1.	<b>486017</b>	245	345	90	<b>95,40</b>
2.	<b>486018</b>	245	345	90	<b>116,90</b>



# BAKERY AND CONFECTIONERY EQUIPMENT

Accessories and appliances helping confectioners and bakers in making all kinds of pastries, desserts and other sweets.

Whipped cream siphon .....	224	Hot chocolate appliance .....	229
Ice cream portioners, cuvettes, cups .....	224	Confectioner's knives .....	229
Bags, extrusion tips .....	225	Cake and fruit platters .....	230-231
Baking paper, baking mats .....	227	Crème brûlée burner .....	231
		Planetary mixers .....	232-233

**WHIPPED CREAM SIPHON**

- siphon to make whipped cream, creams, and cold mousses
- two attachments included
- head made of stainless steel
- easy to use and reliable



Code	V liters	Price net (€)
500250	0,5	93,90
500350	1,0	104,67



**SIPHON CARTRIDGES**

- to make whipped cream, desserts, creams, soups mousses and sauces
- each cartridge contains 8 g of pure N<sub>2</sub>O
- compatible with all siphons available in the market
- cartridges made of high-quality steel

Code	K pcs	Price net (€)
500025	10	4,26
500030	24	10,23
500040	50	21,33

**ROUND CUVETTE**

- cuvette edges gently rounded
- double-wall lid



**ICE CREAM SPATULA**

- handle made of tritanium
- stainless steel work area



Code	Ø mm	H mm	V liters	Price net (€)
535012	200	250	7,3	78,40

Code	Colour	L mm	Price net (€)
533260	transparent	260	7,83



1



2



3

**ICE CREAM CUVETTE**

No.	Code	W mm	D mm	H mm	V liters	Price net (€)
1.	535032	360	165	120	5	24,00
2.	535031	360	250	80	5	24,00
3.	535014	360	165	120	5	21,70
4.	535017	360	250	80	5	19,50



4

**ICE CREAM CONE RACK**

- holes for 4 cones



Code	W mm	D mm	H mm	Price net (€)
536004	95	270	90	32,90



# DECORATIVE TIPS



1



2



3



4



5



6

## 1 START TIP

Code	Ø mm	Price net (€)
515020	2	1,71
515030	3	1,71
515040	4	1,71
515050	5	1,71
515060	6	1,71
515070	7	1,71
515080	8	1,71
515110	11	1,71
515120	12	1,71
515130	13	1,71
515140	14	1,71
515150	15	1,71
515180	18	2,90

## 2 ROUND TIP

Code	Ø mm	Price net (€)
514020	2	1,71
514040	4	1,71
514080	8	1,71
514100	10	1,71

## 3 ROSE TIP

Code	Ø mm	Price net (€)
516050	5	2,90
516060	6	2,90

## 4 PETAL TIP

Code	W mm	D mm	Price net (€)
517011	13	3,0	1,08

## 5 LEAF TIP

Code	W mm	D mm	Price net (€)
517020	8	1	1,08
517021	10	2	1,08

## 6 RIBBON TIP

Code	W mm	D mm	Price net (€)
517030	12	1,5	1,08
517031	16	2,0	1,08

## EXTRUSION BAG STANDARD

- reinforced tip and edge
- with a hanger



Code	L mm	Price net (€)
511252	250	4,80
511302	300	5,77
511452	450	7,35
511532	530	8,46

## DISPOSABLE EXTRUSION BAG

- in a roll
- film thickness: 75 µm



Code	L mm	K pcs	Price net (€)
510010	300	100	23,70
510011	460	100	31,70

CONFECTIONERY  
AND COOKING RING



Code	Ø mm	H mm	Price net (€)
528034	80	45	5,70
528035	100	45	7,22
528036	120	45	8,00

ADJUSTABLE  
CONFECTIONERY RING



INOX

Code	Ø mm	H mm	Price net (€)
528103	120-300	75	9,00

CUTTERS

- smooth



Code	W mm	H mm	Price net (€)
528010	20-110	30	36,10

PLASTIC  
SCRAPER



PP

Code	W mm	D mm	Price net (€)
501125	125	97	1,23

PASTRY PICKER



Code	L mm	Price net (€)
525252	250	5,12

PUNCHING  
ROLLER



PP

Code	W mm	L mm	Price net (€)
504010	60	210	4,34

FROTHER

- 24 wires



Code	L mm	Price net (€)
313251	250	4,60
313301	300	5,10
313401	400	5,50

BRUSH

- wooden handle



Code	W mm	Price net (€)
523040	40	3,23
523080	80	8,77

**STEEL CUP FOR SIFTING**

- ideal for sifting loose products, and preparing and decorating baked goods



Code	Ø mm	H mm	Price net (€)
<b>074450</b>	120	130	<b>12,69</b>

INOX

**ROLLER**

- made of wood
- ball bearings
- L working area
- handle length 130 mm



Code	Ø mm	L mm	Price net (€)
<b>524390</b>	85	395	<b>91,80</b>

**BAKING MAT**

- made of silicon
- thermal resistance: -20 +220°C



Code	W mm	D mm	Price net (€)
<b>521110</b>	520	315	<b>17,20</b>

**BAKING PAPER**

- double-sided silicone coated parchment paper
- intended for baking, cooking, freezing and serving products
- prevents burning
- can be used without fat
- protects dishes from dirt, extends their life time
- for multiple use
- waterproof and biodegradable
- available in ream or roll of paper



No.	Code	Colour	W mm	D mm	L m	T °C	K pcs	Price net (€)
1.	<b>521325</b>	○	325	530	-	-25 + 230	500	<b>54,45</b>
2.	<b>521380</b>	●	380	-	100	-25 + 230	1	<b>21,70</b>







**SPACING MARKER**

- one-sided (smooth)

INOX

Code	Description	Price net (€)
527150	5 knives	69,80
527170	7 knives	110,00



**SPACING MARKER**

- double-sided (corrugated/smooth)

INOX

Code	Description	Price net (€)
527250	5 knives	86,29

INOX



**GUN FOR SAUCES AND CREAMS**

- intended for dispensing sauces, creams, liquid chocolate
- perfect for decorating confectionery or food
- 3 tips included: Ø4,5, Ø5, Ø6,5 mm

No.	Code	Product	Ø mm	H mm	L mm	V liters	Price net (€)
1.	510022	Gun	200	270	2,0	-	50,90
2.	510023	Stand	-	190	-	-	8,01

**GUN FOR SAUCES AND CREAMS**

- intended for dispensing sauces, creams, liquid chocolate
- perfect for decorating confectionery or food
- rack included as standard
- 2 tips included ~Ø=3 and 6 mm
- outlet hole ~ Ø=9mm
- Ø=210 mm ext.
- Ø=190 mm int.

Code	V liters	Price net (€)
510020	1,8	72,90



INOX

**HOT CHOCOLATE APPLIANCE**

- intended for the preparation of hot chocolate
- rotating mixer to ensure proper circulation
- drip tray



Code	W mm	D mm	H mm	V liters	N rpm	M kg	P kW	U V	Price net (€)
469105	410	280	460	5	65~85	7	1	230	656,00

**SPATULA**

- made of stainless steel
- wooden handle



Code	W mm	L mm	Price net (€)
503220	100	220	3,84

**SPATULA FOR CONFECTIONERY**



Code	L mm	Price net (€)
261090	100	6,72

**KNIFE FOR CUTTING PASTRY**

- wavy blade



Code	L mm	Price net (€)
252361	360	36,99

# CAKE PLATTERS

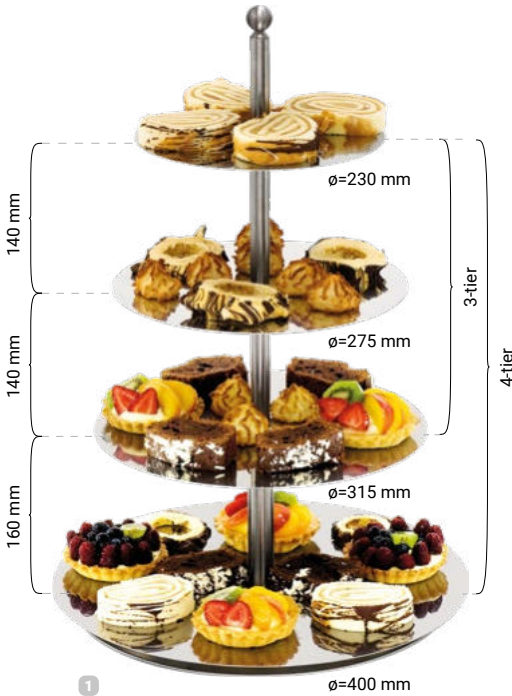

1

## 1 CAKE PLATTER

- multi-level (see table)
- flat plates
- allows stacking plates at will

Code	Product	H mm	Price net (€)
542030	3-level	480	156,00
542040	4-level	600	230,00

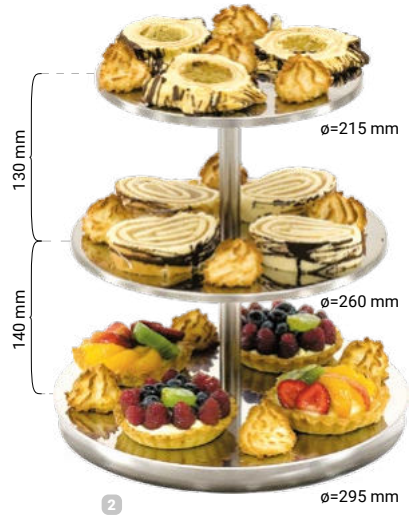

2

## 2 CAKE PLATTER

- 3-level
- flat plates

Code	H mm	Price net (€)
542031	300	94,30



3

## 3 CAKE PLATTER

- swivel base

Code	Ø mm	H mm	Price net (€)
545011	330	50	33,00

## 4 CAKE SPATULA

Code	L mm	Price net (€)
355440	235	10,20



4

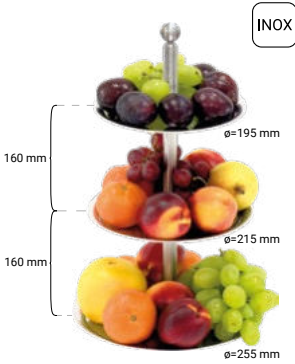

INOX

**FRUIT PLATTER**

- 3-level
- plates with an edge

Code	H mm	Price net (€)
<b>544030</b>	420	<b>84,60</b>



INOX

**FRUIT PLATTER**

- 3-level
- plates with an edge

Code	H mm	Price net (€)
<b>544032</b>	500	<b>101,00</b>



INOX

**FRUIT BASKET**

Code	Ø mm	H mm	Price net (€)
<b>544100</b>	280	380	<b>41,03</b>

**COOKIES AND FRUIT PLATTER**

Code	Ø mm	H mm	H edge mm	Price net (€)
<b>544036</b>	300	85	~ 10	<b>36,00</b>



**CRÈME BRÛLÉE BURNER**

- intended for caramelizing sauces, creams, as well as for wide use in confectionery and gastronomy
- working time at maximum gas loading:  
500600 - up to 75 min  
500700 - up to 90 min
- flame temperature 1300°C
- sold without gas
- childproof lock



Piezo igniter, adjustable burner flame, flame lock button



No.	Code	W mm	D mm	H mm	V liters	Price net (€)
1.	<b>500600</b>	128	65	170	0,04	<b>33,20</b>
2.	<b>500700</b>	153	74	179	0,045	<b>41,50</b>

PLANETARY MIXER

- for light pastry and whipping foam
- model 783050 includes kneading-through with a volume of 5 liters and diameter of 205 mm
- model 783071 includes kneading-through with a volume of 7 liters and diameter of 230 mm
- modern design, base made of aluminum
- parts in direct contact with food are made of stainless steel
- kneading-through equipped with a polycarbonate safety cover with a hole for easy addition of ingredients
- removable kneading-though
- spring mechanism for raising the upper part of the appliance
- wide range of smooth speed adjustment



3 tips included



Code	Ø mm	W mm	D mm	H mm	V liters	M kg	P kW	U V	Price net (€)
<b>782050</b>	205	230	350	400	5	12,2	0,3	230	<b>657,00</b>
<b>783071</b>	230	250	400	410	7	20	0,3	230	<b>688,00</b>

PLANETARY MIXER

- for light pastry and whipping foam
- removable steel kneading-though
- adjustable timer in 30-second increments from 1 to 30 minutes
- electronic, 5-step, infinitely variable speed control
- automatic overload switch
- kneading-though guard with microswitch
- sound signal



Control panel



3 tips included



Code	W mm	D mm	H mm	V liters	M kg	P kW	U V	Price net (€)
<b>783070</b>	345	435	510	7	20	0,65	230	<b>1370,00</b>

**PLANETARY MIXER**

- a bowl with a capacity of 10 l and a set of three nozzles included
- three speed levels
- parts in direct contact with food made of stainless steel
- bowl suspended on movable arms
- safety cover
- bowl diameter 260mm
- removable bowl
- powder coated base



Code	Ø mm	W mm	D mm	H mm	V liters	M kg	P kW	U V	Price net (€)
<b>783100</b>	260	435	460	725	10	48	0,6	230	<b>1250,00</b>



**PLANETARY MIXER**

- for light pastry and whipping foam
- the set includes a 20-liter kneading-through and a set of three tips
- parts in direct contact with food are made of stainless steel
- kneading-through suspended on movable arms
- safety cover
- kneading-through diameter 320 mm
- removable kneading-trough
- appliance body made of aluminum

No.	Code	Product	Price net (€)
1.	<b>785211</b>	Light dough mixing tip	<b>54,00</b>
2.	<b>785213</b>	Foam whipping head	<b>69,00</b>
3.	<b>785214</b>	Kneading-through	<b>88,40</b>



Code	Ø mm	W mm	D mm	H mm	V liters	N rpm	M kg	P kW	U V	Price net (€)
<b>783210</b>	320	470	430	785	20	113/168/400	56	0,75	230	<b>1378,00</b>



**PLANETARY MIXER**

- the set includes a bowl with a capacity of 25 l and a set of three nozzles
- three speed levels
- parts in direct contact with food made of stainless steel
- bowl suspended on movable arms
- safety cover
- bowl diameter 362 mm
- removable bowl
- powder coated base



Code	Ø mm	W mm	D mm	H mm	V liters	M kg	P kW	U V	Price net (€)
<b>783250</b>	362	450	550	900	25	72	1,5	230	<b>1938,00</b>







# PIZZERIA EQUIPMENT

Wide range of equipment and accessories essential in every pizzeria.

Pizza ovens .....	235-243	Pizza trays, mesh .....	249-250
Spiral mixers .....	245-247	Heat-insulated bags, containers .....	250
Pizza shovels, spatulas .....	248-249	Gloves .....	250
Dough containers, oven cleaning brushes .....	249	Pizza refrigerated tables .....	251





## COMPACT PIZZA OVEN

- lines of appliances intended for baking basic types of pizza and casseroles, toasts, quiche, flans or creme brûlée
- oven models for small and medium-sized catering facilities

Oven compartment layout:

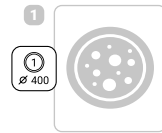

### PIZZA OVEN

- intended for pizza with a diameter of 40 cm
- working range up to 500°C
- chamotte plate at the bottom of the compartment
- independent heater control
- front panel made of stainless steel
- housing made of black-painted steel



Code	Product	W mm	D mm	H mm	W (usable) mm	D (usable) mm	H (usable) mm	M kg	P kW	U V	Price net (€)	Layout
782100	Single-compartment furnace	555	460	290	405	405	110	26	2,2	230	763,23	1
782120	Two-compartment furnace	555	460	535	405	405	180	29	4,4	400	1391,53	1

## PROFESSIONAL PIZZA OVEN

- lines of appliances intended for baking basic types of pizza and casseroles, toasts, quiche, flans or creme brûlée
- oven models for small and medium-sized catering facilities

Oven compartment layout:

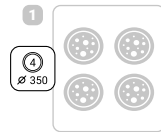

### GREDIL PIZZA OVEN

- intended for pizza with a diameter of 35 cm
- working range up to 450°C
- chamotte plate at the bottom of the compartment
- compartment lighting
- steam venting flue
- independent heater control
- front panel made of stainless steel
- housing made of black-painted steel

**GREDIL**



Code	Product	W mm	D mm	H mm	W (usable) mm	D (usable) mm	H min (usable) mm	M kg	P kW	U V	Price net (€)	Layout
<b>782001</b>	Single-compartment furnace	925	835	335	700	700	140	50	4,8	400	<b>1160,81</b>	1
<b>782002</b>	Two-compartment furnace	925	835	545	700	700	140	91	9,6	400	<b>1708,77</b>	1



Oven compartment layout:

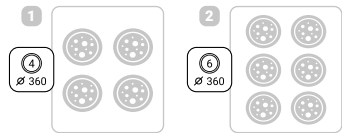

### X-LINE PIZZA OVEN

- intended for pizza with a diameter of 30 and 36 cm
- working range up to 500°C
- chamotte plate at the bottom of the compartment
- compartment lighting
- steam venting flue
- independent heater control
- front panel made of stainless steel
- housing made of black-painted steel



Code	Product	W mm	D mm	H mm	W (usable) mm	D (usable) mm	H (usable) mm	M kg	P kW	U V	Price net (€)	Layout
781421	Single-compartment furnace	1010	850	420	720	720	140	115	6	400	1500,71	1
781422	Two-compartment furnace	1010	850	750	720	720	140	200	12	400	2333,98	1
781432	Two-compartment furnace	1010	1210	750	720	1080	140	300	18	400	2978,76	2



## PROFESIONAL STRONG PIZZA OVEN

- lines of high-performance appliances for baking all types of pizza
- models intended for medium-sized catering facilities

Oven compartment layout:

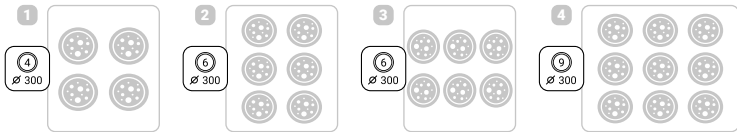

### E-LINE PIZZA OVEN



- intended for pizza with a diameter of 30 cm
- multi-heater heating system
- working range up to 500°C
- chamotte plate at the bottom of the compartment
- compartment lighting
- steam venting flue
- independent heater control
- front panel made of stainless steel
- housing made of black-painted steel



Code	Product	W mm	D mm	H mm	W (usable) mm	D (usable) mm	H (usable) mm	M kg	P kW	U V	Price net (€)	Layout
781501	Single-compartment furnace	900	735	420	610	610	140	78	4,2	400	1610,92	1
781502	Two-compartment furnace	900	735	750	610	610	140	135	8,4	400	2584,27	1
781512	Two-compartment furnace	900	1020	750	610	910	140	178	14,4	400	2932,41	2
781521	Single-compartment furnace	1150	735	420	910	610	140	112	6,4	400	2346,34	3
781522	Two-compartment furnace	1150	735	750	910	610	140	187	12,8	400	3496,85	3
781531	Single-compartment furnace	1150	1020	420	910	910	140	145	9,6	400	2628,56	4
781532	Two-compartment furnace	1150	1020	750	910	910	140	252	19,2	400	4738,00	4



Oven compartment layout:

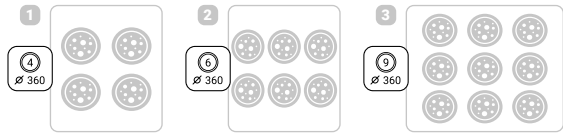

### F-LINE PIZZA OVEN

- intended for pizza with a diameter of 36 cm
- multi-heater heating system
- working range up to 500°C
- chamotte plate at the bottom of the compartment
- compartment lighting
- steam venting flue
- independent heater control
- front panel made of stainless steel
- housing made of black-painted steel



Code	Product	W mm	D mm	H mm	W (usable) mm	D (usable) mm	H (usable) mm	M kg	P kW	U V	Price net (€)	Layout
781601	Single-compartment furnace	1010	850	420	720	720	140	103	5	400	1771,60	1
781602	Two-compartment furnace	1010	850	750	720	720	140	174	12	400	2826,32	1
781702	Two-compartment furnace	1370	850	750	1080	720	140	240	18	400	4185,92	2
781712	Two-compartment furnace	1370	1210	750	1080	1080	140	346	26,4	400	5156,18	3



## PROFESSIONAL STRONG PIZZA OVEN

- lines of high-performance appliances for baking all types of pizza
- models intended for medium-sized catering facilities

Oven compartment layout:

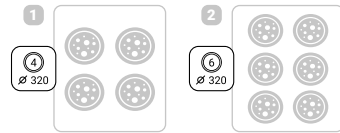

### E-LINE PIZZA OVEN

- intended for pizza with a diameter of 32 cm
- working range up to 500°C
- one-sided grooved chamotte plate
- steam venting flue
- independent heater control
- front panel made of stainless steel
- housing made of black-painted steel



Code	Product	W mm	D mm	H mm	W (usable) mm	D (usable) mm	H (usable) mm	M kg	P kW	U V	Price net (€)	Layout
781301	Single-compartment furnace	900	785	420	660	660	140	73	4,2	400	1365,78	1
781302	Two-compartment furnace	900	785	750	660	660	140	123	8,4	400	2019,83	1
781312	Two-compartment furnace	900	1080	750	660	990	140	159	14,4	400	2436,98	2







## PROFESIONAL GAS STRONG PIZZA OVENS

- line of high-performance appliances for baking all types of pizza
- models intended for medium-sized catering facilities

Oven compartment layout:

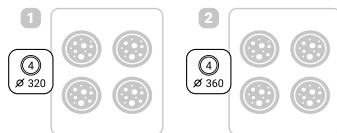

### GAS-LINE PIZZA OVEN

- intended for pizza with a diameter of 30 and 36 cm
- 4-burner heating system
- electronic temperature control adjustment (adjustment every 1 step)
- working range up to 450°C
- piezo flame igniter for burners
- chamotte plate at the bottom of the compartment
- compartment lighting
- compartment entrance reducing temperature loss
- housing made of black-painted steel
- the set includes G30 gas nozzles



Code	Product	W mm	D mm	H mm	W (usable) mm	D (usable) mm	H (usable) mm	M kg	P kW	U V	Price net (€)	Layout
781040	Single-compartment furnace	1000	1010	470	620	620	155	112	13,9	G20	3622,51	1
781045	Single-compartment furnace	1095	1110	472	720	720	155	132	17,0	G20	4276,56	2

## PROFESIONAL EXTRA POWER PIZZA OVENS

- lines of very high-performance appliances for baking all types of pizza
- recommended for catering facilities with high traffic

Oven compartment layout:

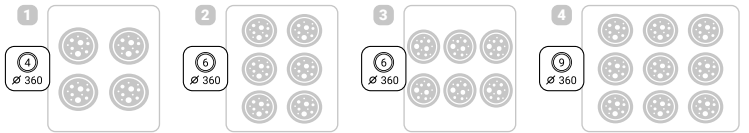

### FR-LINE PIZZA OVEN

- chamotte-lined compartment
- intended for pizza with a diameter of 36 cm
- multi-heater heating system
- working range up to 500°C
- compartment lighting
- steam venting flue
- independent heater control
- front panel made of stainless steel
- housing made of black-painted steel



Code	Product	W mm	D mm	H mm	W (usable) mm	D (usable) mm	H (usable) mm	M kg	P kW	U V	Price net (€)	Layout
781801	Single-compartment furnace	1010	850	420	720	720	140	127	5	400	2221,71	1
781802	Two-compartment furnace	1010	850	750	720	720	140	226	12	400	3631,78	1
781812	Two-compartment furnace	1010	1210	750	720	1080	140	316	18	400	4637,06	2
781901	Single-compartment furnace	1370	850	420	1080	720	140	174	9	400	2899,45	3
781902	Two-compartment furnace	1370	850	750	1080	720	140	306	18	400	5190,17	3
781912	Two-compartment furnace	1370	1210	750	1080	1080	140	436	26,4	400	7108,03	4



## BASE FOR OVEN

BASE FOR OVEN  
• bolted structure

PL STALGAST  
RADOM



Code	Product	W mm	D mm	H mm	Price net (€)
<b>782010</b>	Base for oven 782001, 782002	785	770	1000	<b>368,00</b>
<b>782011</b>	Base for oven 781501, 781502	910	745	1000	<b>368,00</b>
<b>782012</b>	Base for oven 781411, 781511, 781512	910	1030	1000	<b>368,00</b>
<b>782013</b>	Base for oven 781040, 781421, 781422, 781601, 781602, 781801, 781802	1020	860	1000	<b>368,00</b>
<b>782014</b>	Base for oven 781431, 781432, 781611, 781811, 781812	1020	1220	1000	<b>368,00</b>
<b>782015</b>	Base for oven 781521, 781522	1160	745	1000	<b>368,00</b>
<b>782016</b>	Base for oven 781531, 781532	1160	1030	1000	<b>368,00</b>
<b>782017</b>	Base for oven 781702, 781901, 781902	1380	860	1000	<b>368,00</b>
<b>782018</b>	Base for oven 781711, 781712, 781911, 781912	1380	1220	1000	<b>368,00</b>
<b>782019</b>	Base for oven 781045	1095	940	1000	<b>368,00</b>
<b>782020</b>	Base for oven 781301, 781302	905	795	1000	<b>368,00</b>
<b>782021</b>	Base for oven 781312	905	1090	1000	<b>368,00</b>
<b>782022</b>	Base for oven 782100, 782120	565	470	1000	<b>202,00</b>

**DOUGH ROLLER**

- appliance for rolling dough for pizza and bread
- the roller greatly simplifies and speeds up work
- dough thickness adjustment from approx. 1 ÷ 4 mm
- roll length L=300 mm
- recommended dough weight: 80-210 g
- appliance made of stainless steel
- 2 operating modes: continuous operation/foot switch



Foot switch



Code	W mm	D mm	H mm	M kg	P kW	U V	Price net (€)
<b>786931</b>	445	340	640	29	0,5	230	<b>1377,00</b>

**SPIRAL MIXER**

- for heavy dough e.g. pizza, dumplings
- 786100 maximum kneading-through volume up to 6.5 kg (dough)
- 786200 maximum kneading-through volume up to 15 kg (dough)
- parts in direct contact with food are made of stainless steel
- permanently installed kneading-through



Stainless steel kneading-through and hook



Control panel



No.	Code	Ø mm	W mm	D mm	H mm	V liters	N rpm	M kg	P kW	U V	Price net (€)
1.	<b>786100</b>	340	360	680	750	10	15	68	0,55	230	<b>999,00</b>
2.	<b>786200</b>	360	380	670	735	20	15	70	0,75	230	<b>1467,00</b>

**SPIRAL MIXER**

- for heavy doughs
- digital panel to control speed and operating time
- 10 speed levels
- maximum kneading-trough capacity of 5.2 kg (dough)
- parts in direct contact with food are made of stainless steel
- metal movable kneading-trough guard
- kneading-trough reverse
- sound signal

Stainless steel kneading-trough and hook



Control panel



Code	W mm	D mm	H mm	V liters	M kg	P kW	U V	Price net (€)
<b>786010</b>	320	550	440	10	32	0,75	230	<b>1270,00</b>

**SPIRAL MIXER**

- for heavy doughs
- digital panel to control speed and operating time
- 10 speed levels
- 786023 maximum kneading-trough capacity of 12 kg (dough)
- 786034 maximum kneading-trough capacity of 18.7 kg (dough)
- 786045 maximum kneading-trough capacity of 30 kg (dough)
- parts in direct contact with food are made of stainless steel
- metal movable kneading-trough guard
- feet to stabilize the device
- kneading-trough reverse
- sound signal
- infinitely variable speed control
- "Pause" function

Control panel



Stainless steel kneading-trough and hook



Code	W mm	D mm	H mm	V liters	M kg	P kW	U V	Price net (€)
<b>786023</b>	730	550	770	23	90	1,3	230	<b>2260,00</b>
<b>786034</b>	850	520	860	34	120	1,8	230	<b>2740,00</b>
<b>786045</b>	850	520	920	45	145	2,6	230	<b>3430,00</b>





**SPIRAL MIXER**



- for heavy dough e.g. pizza, dumplings
- 786102 maximum kneading - through volume up to 8 kg (dough)
- 786202 maximum kneading - through volume up to 15 kg (dough)
- 786302 maximum kneading - through volume up to 22 kg (dough)
- parts in direct contact with food are made of stainless steel
- permanently installed kneading - through

Code	W mm	D mm	H mm	M kg	P kW	U V	Price net (€)
<b>786102</b>	300	550	620	48	0,37	230	<b>1324,00</b>
<b>786202</b>	400	700	680	82	0,90	230	<b>1627,00</b>
<b>786302</b>	450	740	730	90	1,10	230	<b>1889,00</b>

**SPIRAL MIXER**

- for heavy dough e.g. pizza, dumplings
- speeds:  
spiral rotational speed 92-139 rpm  
kneading-through rotational speed 9-14 rpm
- raised head and removable kneading-through
- 786402 maximum kneading - through volume up to 18 kg (dough)
- 786502 maximum kneading - through volume up to 25 kg (dough)
- parts in direct contact with food are made of stainless steel

Code	W mm	D mm	H mm	M kg	P kW	U V	Price net (€)
<b>786402</b>	400	700	700	94	0,55	400	<b>2490,00</b>
<b>786502</b>	450	740	750	127	1,10	400	<b>3200,00</b>



**SPIRAL MIXER**



- for heavy dough e.g. pizza, dumplings
- raised head and removable kneading - through
- 786400 maximum kneading - through volume up to 18 kg (dough)
- 786500 maximum kneading - through volume up to 25 kg (dough)
- parts in direct contact with food are made of stainless steel

Code	W mm	D mm	H mm	M kg	P kW	U V	Price net (€)
<b>786400</b>	400	700	700	100	0,9	230	<b>2350,00</b>
<b>786500</b>	450	740	750	128	1,3	230	<b>2490,00</b>

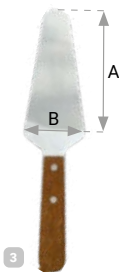
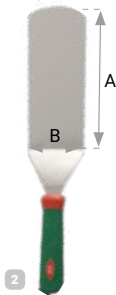
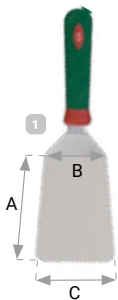

**1 PIZZA SPATULA**

- non-slip handle
- A=120 mm, B=75 mm, C=90 mm



Code	L mm	Price net (€)
<b>270150</b>	150	<b>59,10</b>

**2 PIZZA SPATULA**

- non-slip handle
- A=200 mm, B=80 mm



Code	L mm	Price net (€)
<b>270260</b>	260	<b>74,40</b>

**5 PIZZA SPADE**

- made of aluminum
- wooden handle

Code	W mm	D mm	L mm	Price net (€)
<b>564022</b>	260	300	200	<b>17,70</b>
<b>564052</b>	260	300	450	<b>27,00</b>
<b>564102</b>	260	300	1000	<b>34,90</b>

**3 PIZZA SPATULA**

- wooden handle
- A=120 mm, B=60 mm



Code	L mm	Price net (€)
<b>503210</b>	270	<b>3,55</b>

**4 PIZZA CUTTING WHEEL**

- straight blade

Code	Ø mm	Price net (€)
<b>561101</b>	100	<b>5,67</b>

**6 PIZZA SPADE**

- made of beech wood



Code	W mm	D mm	L mm	Price net (€)
<b>564030</b>	350	300	1100	<b>38,50</b>



**PIZZA SPADE**

- made of aluminum

Code	W mm	D mm	H mm	Price net (€)
<b>564412</b>	320	300	1200	<b>62,10</b>



**PIZZA PEEL**

- made of aluminum

Code	Ø mm	L mm	Price net (€)
<b>564413</b>	200	1690	<b>65,90</b>



**BRUSH FOR CLEANING OVENS**

- bristles made of brass
- allows adjusting the brush

Code	L mm	Price net (€)
<b>564411</b>	1500	<b>73,90</b>



1



4



3



6

**DOUGH CONTAINER**

- perfect for pizza dough, pasta, etc.



No.	Code	Product	W mm	D mm	H mm	V liters	Price net (€)
1.	<b>563407</b>	Container	600	400	70	13	<b>31,80</b>
2.	<b>563410</b>	Container	600	400	100	19	<b>21,90</b>
3.	<b>563411</b>	Container	400	300	100	10	<b>12,80</b>
4.	<b>563408</b>	Cover for 563407 and 563410	600	400	20	-	<b>12,90</b>
5.	<b>563412</b>	Cover for 563411	400	300	20	-	<b>10,40</b>

**6 CART FOR PIZZA DOUGH CONTAINER**

- for containers 600x400



Code	Price net (€)
<b>563409</b>	<b>87,90</b>

## PIZZA TRAY

- after finishing work, each tray should be thoroughly washed, dried and greased; this treatment serves to protect the tray against corrosion



Code	Ø mm	H mm	Price net (€)
560241	240	25	5,38
560261	260	25	6,40
560281	280	25	6,50
560301	300	25	7,71
560321	320	25	8,11
560361	360	25	9,49
560401	400	25	12,60
560451	450	40	19,70
560501	500	40	19,90

## PIZZA MESH



Code	Ø mm (internal)	Ø mm (external)	Price net (€)
562281	250	280	4,85
562311	280	300	5,13
562330	310	330	5,52
562361	350	380	6,03
562400	380	400	6,84
562460	430	460	8,23
562500	480	500	10,20
562600	570	600	22,30

## PIZZA BAG

- made of strong material - nylon, damage-resistant
- polyester insulation maximally retains temperature, prevents moisture and smell penetration
- large, tilting flap
- transparent pocket for bills 120x180 mm
- has a hanger knot and ventilation holes



## PIZZA BAG

- made of durable vinyl material
- thick insulation retains the temperature, prevents moisture penetration
- large, tilting flap with velcro
- transparent pocket for bills with dimensions (WxD) 165x120 mm
- has comfortable grip for handling and vents



Code	W mm	D mm	H mm	W (usable) mm	D (usable) mm	H (usable) mm	Price net (€)
563452	550	500	200	510	500	200	22,28

Code	W mm	D mm	H mm	W (usable) mm	D (usable) mm	H (usable) mm	Price net (€)
563453	500	500	300	480	480	285	21,10

## BAKING GLOVES

- made of leather
- 3-finger



Code	T °C	Price net (€)
505011	do 300	50,50

## OVEN GLOVES

- fireproof impregnated cotton
- 2-finger



Code	L mm	T °C	Price net (€)
505013	430	do 230	11,70

## BAKING GLOVES

- made of leather
- 2 fingers



Code	L mm	T °C	Price net (€)
505014	410	do 250	55,66

**REFRIGERATED PIZZA COUNTER**

- housing and interior made of stainless steel
- dynamic air circulation
- electronic controller with temperature display
- dust filter
- self-closing doors with locking mechanism
- GN 1/1 standard chamber
- 2 grates with guides included
- automatic and manual defrost function
- extension capacity of 5 x GN 1/6 (max. 150 mm)
- insulation thickness of ~35 mm
- granite countertop
- 2 GN 1/1 shelves
- dedicated guides - code 841443



Code	Container layout	W mm	D mm	H mm	T °C	P kW	U V	V liters	V liters net	Climate class	Price net (€)
<b>833029</b>	5 x GN 1/6	900	700	1090	+2 / +8	0,17	230	240	198	4	<b>1163,00</b>

**REFRIGERATED PIZZA COUNTER WITH DISPLAY CASE ON WHEELS**

- housing and interior made of stainless steel
- dynamic air circulation
- electronic controller with temperature display
- dust filter
- self-closing doors with locking mechanism
- automatic and manual defrost function
- dedicated display case - code 834630 and 834641
- front wheels equipped with a brake
- top made of granite
- układ pojemników nadstawy:  
834630: volume 6x GN 1/3 (max H = 150 mm)  
834641: volume 6x GN 1/4 (max H = 150 mm)
- 3 GN 1/1 shelves included
- dedicated guides - code 831443
- dedicated shelf - code 831445
- sold without GN containers
- display case sold separately

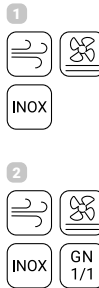

No.	Code	W mm	D mm	H mm	T °C	P kW	U V	Energy class	Energy consumption kWh/year	V liters	V liters net	Climate class	Price net (€)
1.	<b>834630</b>	1400	395	440	+2 / +8	0,11	230	-	-	-	-	4	<b>769,00</b>
	<b>834641</b>	1400	335	440	+2 / +8	0,11	230	-	-	-	-	4	<b>673,00</b>
2.	<b>833031</b>	1400	700	1120	+2 / +8	0,24	230	D	1294	368	297	4	<b>1697,00</b>

**REFRIGERATED PIZZA COUNTER WITH DISPLAY CASE**

- housing and interior made of stainless steel
- dynamic air circulation
- electronic controller with temperature display
- dust filter
- self-closing doors with locking mechanism
- GN 1/1 standard chamber
- 3 grates with guides included
- automatic and manual defrost function
- 3 GN shelves
- dedicated guides - code 841443



Code	Container layout	W mm	D mm	H mm	T °C	P kW	U V	Energy consumption kWh/year	V liters	V liters net	Climate class	Price net (€)
<b>833037</b>	8 x GN 1/6	1365	700	1090	+2 / +8	0,24	230	1294	402	308	4	<b>1724,00</b>



## MECHANICAL TREATMENT

Appliances used in both small and large gastronomy for cutting, grinding, chopping, peeling, shredding and mixing various types of food.

Potato peeler .....	253	Meat grinders .....	255-256
Slicing machines .....	254	Sausage fillers, sausage slicer .....	257
Steak makers and accessories .....	255	Vegetable cutter .....	258

## PEELER

- laser-engraved ergonomic control panel
- single batch up to 6 or 12 kg (depending on the model)
- silent work
- polycarbonate lid with safety switch
- timer with adjustment up to 5 minutes
- peeling separator code 786003 sold separately

New design

Improved  
appliance design

1



2



3

The new,  
appropriately tilted  
design of the control  
panel ensures comfort  
and safety of use



Abrasive wheel



No.	Code	Product	W mm	D mm	H mm	S kg/h	P kW	U V	Price net (€)
1.	<b>789061</b>	Potato peeler	450	830	930	60	0,55	400	<b>1632,00</b>
2.	<b>789120</b>	Potato peeler	450	830	930	120	0,55	400	<b>2030,00</b>
3.	<b>789003</b>	Peel separator	315	562	160	-	-	-	<b>160,00</b>

## SLICER FOR CURED MEAT AND CHEESE



- housing made of anodized aluminum
- removable trolley makes it easy to keep clean
- built-in sharpener
- cutting adjustment 0-10 mm
- knife cover, the movable wall and knife are covered with a non-stick coating



Code	Ø mm (knife)	W mm	D mm	H mm	M kg	P kW	U V	Price net (€)
<b>722252</b>	250	380	490	380	16	0,32	230	<b>689,00</b>
<b>722221</b>	220	380	440	340	14	0,32	230	<b>620,00</b>

## SLICER FOR CURED MEAT



- housing made of anodized aluminum
- removable trolley makes it easy to keep clean
- built-in sharpener
- cutting adjustment 0-10 mm



Code	Ø mm (knife)	W mm	D mm	H mm	M kg	P kW	U V	Price net (€)
<b>722255</b>	250	380	490	380	16	0,32	230	<b>658,00</b>

**STEAK MAKER**

- recommended for restaurants, butchers, kebab joints, etc.
- designed to soften and prepare meat for chops, cuts, fillets, steaks
- performance up to 420 cutlets/hour
- size of batch input 158x23 mm
- non-slip feet
- cutter included as standard



Code	W mm	D mm	H mm	P kW	U V	Price net (€)
<b>721570</b>	500	310	500	0,37	230	<b>1338,70</b>

**CRUSHING SHAFTS**

- recommended to prepare meat for chops, bits
- replace the traditional meat hammering using pounder
- shafts dedicated to the model: 721570
- crushing rollers are not suitable for processing poultry meat



Code	Price net (€)
<b>721571</b>	<b>220,00</b>

**MEAT GRINDER**

- housing made of anodized aluminum
- feeder made of stainless steel
- head and auger made of anodized aluminum
- strainers and knife made of carbon steel
- pusher made of polyethylene
- reverse gear
- strainers: 721011; 721012; 721013; 721014; 721015; 721016; knife: 721010
- temporary capacity 125 kg/h
- complete with 3 strainers 3, 5, and 8 mm (mesh diameter)
- mesh diameter - 68 mm
- overload protection - non-slip feet
- includes funnel for stuffing sausages and a dumpling filling tip for small catering establishments
- the appliance is not intended for continuous operation



Code	W mm	D mm	H mm	S kg/h	P kW	U V	Price net (€)
<b>721129</b>	410	190	350	85	0,25	230	<b>414,00</b>



## MEAT GRINDER

- base made of anodized aluminum and stainless steel
- removable head for easy cleaning
- head, auger and tray made of stainless steel
- reverse to facilitate the unscrewing of the strainer
- overload protection
- non-slip feet
- continuous work up to 8 hours
- strainers included as standard: 721121 - 5 and 8 mm, 721221 - 6 and 8 mm



No.	Code	W mm	D mm	H mm	S kg/h	P kW	U V	Price net (€)
1.	<b>721121</b>	499	270	550	do 160	0,8	230	<b>1031,00</b>
2.	<b>721221</b>	530	270	500	do 300	1,1	230	<b>1097,00</b>

## MEAT GRINDER

- base made of anodized aluminum and stainless steel
- input funnel made of polished aluminum alloy
- tray made of stainless steel
- throat made of cast iron
- worm screw made of special aluminum alloy
- reverse to facilitate the unscrewing of the strainer
- continuous work up to 8 hours
- non-slip feet
- complete with strainers: 721124 - 5 and 8 mm, 721224 - 6 and 8 mm

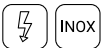

No.	Code	W mm	D mm	H mm	S kg/h	P kW	U V	Price net (€)
3.	<b>721124</b>	517	328	410	220	0,80	230	<b>769,00</b>
4.	<b>721224</b>	410	328	517	250	0,80	230	<b>992,00</b>

## ACCESSORIES FOR MEAT GRINDERS

- the table shows the diameter of mesh in the strainer



No.	Code	Ø mm	Suitable for	Price net (€)
1.	<b>721010</b>	-	721121, 721124, 721129	<b>11,10</b>
	<b>721020</b>	-	721221, 721224	<b>13,10</b>
2.	<b>721011</b>	2,5	721121, 721124, 721129	<b>28,70</b>
	<b>721012</b>	3	721121, 721124, 721129	<b>28,10</b>
	<b>721013</b>	4,5	721121, 721124, 721129	<b>25,80</b>
	<b>721014</b>	6	721121, 721124, 721129	<b>25,30</b>
	<b>721015</b>	8	721121, 721124, 721129	<b>24,80</b>
	<b>721016</b>	10	721121, 721124, 721129	<b>25,80</b>
	<b>721022</b>	3	721221, 721224	<b>33,49</b>
	<b>721023</b>	4,5	721221, 721224	<b>29,80</b>
	<b>721025</b>	8	721221, 721224	<b>31,84</b>

## SAUSAGE FILLERS

- excellent quality appliances, intended for use in non-mass catering production as well as for amateur sausage production
- with its reliable and simple design, the appliance is easy, intuitive and convenient to use. High-quality materials used in the appliance guarantee reliable operation and long durability
- filling cylinder is mounted on both sides of the appliance's body, making it easy to use for left- and right-handed users

### SAUSAGE FILLER

- reliable design made of stainless steel
- all removable parts of the device can be washed in a dishwasher
- piston equipped with a batch vent and a flexible replaceable gasket
- drive with gear reduction and two speeds of operation
- appliance equipped with 4 steel replaceable sausage funnels with the following sizes: 16, 22, 32, 38 mm.
- cylinder loading possible without having to disassemble it completely
- easy and even dosing of the filler batch

No.	Code	W mm	D mm	H mm	V liters	M kg	Price net (€)
1.	<b>721305</b>	320	290	680	5	11	<b>283,00</b>
2.	<b>721307</b>	320	330	830	7	12	<b>333,00</b>
3.	<b>721310</b>	400	360	640	10	12	<b>341,01</b>



INOX

### SAUSAGE SLICER

- appliance intended for slicing sausage
- automatic start-up function
- double sickle knife with cutting adjustment from 5 to 30 mm
- non-slip feet

Code	W mm	D mm	H mm	M kg	P kW	U V	Price net (€)
<b>725001</b>	248	189	326	7,1	0,12	230	<b>215,97</b>



INOX



## VEGETABLE CUTTER

- suitable for hotels, restaurants, canteens
- excellent for cutting vegetables of all sizes

### VEGETABLE CUTTER WITH SET OF 5 BLADES

- suitable for hotels, restaurants, canteens excellent for cutting big and small vegetables
- cast aluminium housing
- safety micro-switch
- 5 blades included: shredders  $\varnothing=2$ ,  $\varnothing=4$ ,  $\varnothing=6$  mm and slices 2, 4 mm
- two functional inlets: 160x75 mm and  $\varnothing=50$  mm

Set of 5 blades



Code	W mm	D mm	H mm	S kg/h	M kg	P kW	U V	Price net (€)
<b>713003</b>	230	570	510	up to 40	22,5	0,55	230	<b>949,00</b>



## THERMAL TREATMENT

Small kitchen appliance that complements the kitchen equipment, as well as basic tools for heat treatment of various types of food.

Contact grills .....	262-263	Roller heater for sausages.....	260
Deep fryers .....	260, 264	Chicken grill .....	267
Wafer crepe makers.....	266	Adjustable bain-maries.....	265
Grill hobs .....	261, 264	Toasters, salamander .....	261
Microwaves.....	268-270	Induction cooker .....	271
Heating display case .....	267	Sous Vide circulator .....	272





**FRYERS**

- housing made of stainless steel
- removable frying grease containers
- thermostat adjustment range 60–190°C
- safety thermostat
- baskets with folding handle



1



3

No.	Code	Product	W mm	D mm	H mm	Basket dimensions WxDxH mm	V liters	P kW	U V	Price net (€)
1.	<b>746035</b>	Single fryer	170	420	270	240x125x100	3	2,2	230	<b>103,85</b>
2.	<b>746050</b>	Single fryer	260	420	270	240x205x100	5	3,2	230	<b>162,00</b>
3.	<b>746100</b>	Double fryer	540	420	270	240x205x100	2 x 5	2 x 3,2	230	<b>278,00</b>

**ROLLER HEATER FOR SAUSAGES**

- heated non-stick rollers
- two heating zones
- removable drip tray
- smooth temperature control
- wash after each use; leaving residue will block the rollers



Code	N° rolls	W mm	D mm	H mm	P kW	U V	Price net (€)
<b>770100</b>	11	550	475	175	1,1	230	<b>354,00</b>

**TOASTER**

- housing made of stainless steel
- timer switch
- chamber size WxDxH: 455x260x160 mm
- fuse to prevent overheating the appliance
- height-adjustable grate with handgrips (4 positions)

Grate made of chromed steel



Code	W mm	D mm	H mm	M kg	P kW	U V	Price net (€)
<b>743000</b>	640	320	300	15	2,0	230	<b>236,00</b>

**SANDWICH HOLDER**

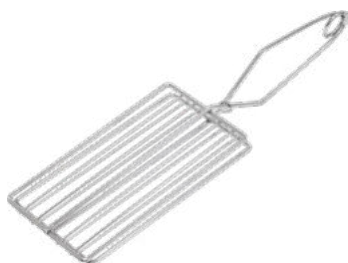

Code	W mm	D mm	Price net (€)
<b>779198</b>	340	95	<b>3,73</b>



## CONTACT GRILL

**GREDIL**

- housing made of stainless steel
- corrugated cast iron plates
- two heating zones, top and bottom
- fuse to prevent overheating the appliance
- trough for grease and grilling residue
- smooth temperature control 50–300°C

Control panel



Grease and debris collection gutter

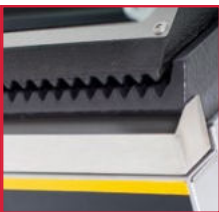

Corrugated surface



Code	W mm	D mm	H mm	T °C	M kg	P kW	U V	Price net (€)
<b>742010</b>	265	325	200	50-300	12,5	1,8	230	<b>241,00</b>



## CONTACT GRILLS

caterina 

- solid double sided ribbed working surface for perfect temperature distribution
- bottom plate with edge for comfort and hygienic work
- temperature control up to 300°C
- safety thermostat
- work switch and set temperature indicator
- heat resistant handle
- tray for grease and grilling residue
- available in single, double and Panini version



SINGLE CONTACT GRILL

Code	W mm	D mm	H mm	P kW	U V	Price net (€)
742018	310	360	200	1,8	230	281,00



PANINI CONTACT GRILL

Code	W mm	D mm	H mm	P kW	U V	Price net (€)
742038	430	360	200	2,2	230	323,00

DOUBLE CONTACT GRILL

Code	W mm	D mm	H mm	P kW	U V	Price net (€)
742028	570	360	200	3,6	230	482,00



Corrugated surface



FRYER



- available in single and double version with drain tap
- solid basket and lid equipped with handgrips resistant to high temperatures
- temperature control knob 60-200°C
- "cold zone" system preventing burning
- removable control panel for easy cleaning



No.	Code	Product	W mm	D mm	H mm	V liters	P kW	U V	Price net (€)
1.	<b>746067</b>	Single fryer	200	430	315	5	2	230	<b>207,00</b>
	<b>746069</b>	Single fryer	290	430	265	5	3	230	<b>210,00</b>
2.	<b>746068</b>	Double fryer	415	430	315	2x5	2x2	230	<b>392,00</b>
	<b>746079</b>	Double fryer	585	430	265	10	6	230	<b>354,00</b>
3.	<b>746096</b>	Single fryer with tap	300	510	390	8	3	230	<b>294,00</b>
	<b>746097</b>	Double fryer with tap	610	510	390	2x8	6	230	<b>539,00</b>

ELECTRIC COUNTERTOP GRIDDLE

- heating plate 2/3 smooth; 1/3 ribbed
- 2 heating zones
- temperature control by knob 50-300°C
- fast heat up of plate
- work switch and set temperature indicator
- safety edge
- grease drawer



Code	W mm	D mm	H mm	P kW	U V	Price net (€)
<b>745104</b>	720	460	240	3,5	230	<b>623,00</b>

### WAFFER MAKER

- temperature adjustment by knob 50-300°C
- work switch and set temperature indicator
- timer up to 5 min
- heat resistant handle



Wafer  
dimensions

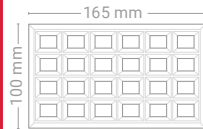

Code	W mm	D mm	H mm	P kW	U V	Price net (€)
<b>772326</b>	320	380	240	1,5	230	<b>395,00</b>

### PANCAKE MAKER

- cast iron hob with teflon coating
- temperature adjustment by knob 50-300°C
- work switch and set temperature indicator
- spatulas sold in sets of 5



2



1

No.	Code	Product	Ø mm	W mm	D mm	H mm	P kW	U V	Price net (€)
1.	<b>772284</b>	Crepe maker	400	450	470	220	3	230	<b>344,00</b>
2.	<b>772289</b>	Wooden round spatula	-	180	180	-	-	-	<b>14,40</b>

### DROP-IN BAIN-MARIE

- appliances made of stainless steel
- fitted with a fuse to prevent overheating
- model 741155 and 741156 batch: GN 1/1 150 mm
- model 741205 batch: GN 1/1 200 mm

Tap version  
available



Code	Product	W mm	D mm	H mm	T °C	P kW	U V	Price net (€)
<b>741155</b>	Drop-in bain-marie	340	570	242	0-85	1,2	230	<b>160,00</b>
<b>741156</b>	Drop-in bain-marie with a tap	340	590	242	0-85	1,2	230	<b>189,00</b>
<b>741205</b>	Drop-in bain-marie with a tap	340	590	280	0-85	1,2	230	<b>217,00</b>



**ELECTRIC GYROS KNIFE**

- cutting width 0.5 ÷ 8 mm
- blade diameter 100 mm

Includes:  
100 mm knife,  
knife sharpener



Code	W mm	D mm	H mm	N rpm	M kg	P kW	U V	Price net (€)
<b>774901</b>	125	170	190	2200	0,8	0,08	230	<b>175,50</b>

**ELECTRIC GYROS KNIFE**

- non-slip rubber housing
- cutting thickness 0.5÷8 mm
- blade diameter 100 mm
- complete with: 2 knives and a sharpener

Code	W mm	D mm	H mm	N rpm	M kg	P kW	U V	Price net (€)
<b>774905</b>	125	170	190	2200	0,8	0,08	230	<b>146,73</b>



**RICE COOKING APPLIANCE**

- easy to clean, non-stick internal container
- stainless steel housing
- removable container
- spoon and fork and 2 scoops included as standard
- automatically goes through the heating process after cooking rice
- practical measuring scale inside the bowl
- prepares from 10 to 36 servings of rice
- do not use sharp tools

Includes  
2 measuring  
cups, spoon  
and fork



Code	W mm	D mm	H mm	V liters	M kg	P kW	U V	Price net (€)
<b>771101</b>	470	420	350	6	10,2	1,95	230	<b>243,00</b>



**CHICKEN GRILL**

- intended for roasting poultry, venison, roast, pork knuckles etc.
- 3 independently controlled skewers
- capacity 12-15 chickens
- average LPG consumption 1.41 kg/h; natural gas 1.86 m<sup>3</sup>/h
- chamber lighting
- removable drip tray
- includes nozzles for G20 and G30



**HEATING DISPLAY**

- stainless steel housing
- LED lighting
- adjustable shelves
- 4 wheels, 2 with brakes

INOX



Code	W mm	D mm	H mm	M kg	P kW	U	Price net (€)
<b>785300</b>	1110	480	920	87	17	gaz	<b>2795,00</b>

**FOOD DRYER, 10 TRAYS DEHYDRATOR**

- stainless steel housing
- ideal device for drying fruit, vegetables, meat, fish, etc.
- digital control panel
- working time regulation from 0 to 24 hours with 30 minutes intervals
- temperature regulation, range from 35 to 75 °C with 5 °C intervals
- the set includes 10 grates ~ 400x395 mm, the maximum load per grate is ~ 0.6 kg
- hot air distributed by a silent fan ensures even drying result, no need to turn the trays around
- transparent door allows to observe the drying process



Code	W mm	D mm	H mm	P kW	U V	Price net (€)
<b>690310</b>	430	535	420	1,10	230	<b>406,00</b>



Code	W mm	D mm	H mm	V liters	T °C	P kW	U V	Price net (€)
<b>852220</b>	494	600	1742	220	+30 / +80	2	230	<b>1990,00</b>

**MICROWAVE**

900w [25l]

- manual control
- 5 power levels
- defrost function
- 270 mm rotating disc
- clock range of 30 min
- chamber and appliance housing made of stainless steel
- chamber size: 340x345x230 mm



Code	W mm	D mm	H mm	P W	U V	Price net (€)
<b>775002</b>	483	420	281	900	230	<b>214,00</b>

**MICROWAVE**

1000w [25l]

- electronic control
- 3 power levels
- allows saving 20 programs in 3 steps
- clock range 1h 40min
- allows using polycarbonate GN 1/2 h = 65 x 150 mm for thawing
- chamber and appliance housing made of stainless steel
- chamber internal dimensions: 335x364x212 mm



Code	W mm	D mm	H mm	P W	U V	Price net (€)
<b>775010</b>	520	442	312	1000	230	<b>476,00</b>

MICROWAVE

- manual control, 5 power levels  
100%, 70%, 50%, 30%, 15%
- an effective magnetron guarantees even heating and gentle defrosting of products
- interior easy to keep clean
- no moving parts in the oven's bottom
- chamber internal dimensions: 336x349x225 mm



[26i]

1050w

INOX

[2]

Code	Description	W mm	D mm	H mm	P W	U V	Price net (€)
<b>775313</b>	Manual panel	517	412	297	1050	230	<b>484,00</b>

MICROWAVE

- electronic touchscreen control panel
- internal dimensions: 336x349x225 mm
- 4 power levels
- allows saving 20 programs
- LED display
- 2 stages of cooking
- maximum cooking time 30 minutes
- end of cooking cycle alarm
- +30 sec. button
- defrost button



[26i]

1100w

INOX

[2]

Code	Description	W mm	D mm	H mm	P W	U V	Price net (€)
<b>775412</b>	Electronic panel	527	412	297	1100	230	<b>522,00</b>

MICROWAVE

- manual control, 5 power levels
- end of the cycle sound signal
- ceramic bottom, double interior lighting
- „REPEAT“ function repeating the last cycle
- „ONE TOUCH“ function automatically extends the cycle with a single touch for 20 more seconds
- The dual microwave emission source located at the top of the chamber guarantees even food heating
- internal dimensions: 370x370x190 mm



[26i]

1500w

1850w

INOX

[2]

Code	Description	W mm	D mm	H mm	P W	U V	Price net (€)
<b>775315</b>	Manual panel	464	597	368	1500	230	<b>1143,00</b>
<b>775319</b>	Manual panel	464	597	368	1850	230	<b>1322,00</b>



## MICROWAVE

- electronic touchscreen control panel with 5 power levels 100%, 70%, 50%, 25%, 13%
- two effective and efficient magnetrons guarantee even heating and gentle defrosting of products
- allows creating and saving 30 own programs
- interior easy to keep clean
- no moving parts in the oven's bottom
- chamber internal dimensions: 370x370x190 mm



Code	Description	W mm	D mm	H mm	P W	U V	Price net (€)
<b>775415</b>	Electronic panel	464	597	368	1500	230	<b>1038,00</b>

## MICROWAVE

- electronic touchscreen control panel with 5 power levels 100%, 70%, 50%, 20%, 10%
- two effective and efficient magnetrons guarantee even heating and gentle defrosting of products
- allows creating and saving 30 own programs
- interior easy to keep clean
- no moving parts in the oven's bottom
- chamber internal dimensions: 370x370x190 mm

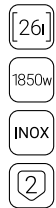

Code	Description	W mm	D mm	H mm	P W	U V	Price net (€)
<b>775419</b>	Electronic panel	464	597	368	1850	230	<b>1280,00</b>

## INDUCTION COOKER

- housing made of plastics
- electronic safety control to prevent overheating
- smooth temp. control 60-240 °C
- display of working parameters
- pot detection system
- induction field with a diameter of 190 mm
- non-slip feet



Code	W mm	D mm	H mm	M kg	P kW	U V	Price net (€)
<b>770201</b>	298	360	65	2,5	2,0	230	<b>93,12</b>

# INDUCTION COOKER

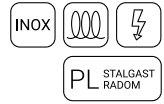

- professional induction stove dedicated to small and medium gastronomy, also great at home
- reduces energy consumption by approx. 45% compared to traditional heating equipment
- stainless steel housing made in extrusion technology
- impact-resistant ceramic induction hob
- automatic detection of dishes and adjustment of the heating surface to their diameter (2 zones)
- bottom diameter of the vessels used  $\varnothing=120 - \varnothing 260$  mm

## Requires using dishes designed for induction technology:



## Glass touchscreen panel with dedicated timer

- work at constant power 10-20 level (1-9 pulse work), adjustable in steps
- ability to work with timer 001-479 min - set every 1 min
- 3 quick setting levels depending on the operating mode:
  - 1/10/20 for power mode or
  - 50/140/240 for temperature mode
- work with preset temperature 50-240°C (step adjustment)

Code	W mm	D mm	H mm	P kW	U V	Price net (€)
770351	325	425	100	3,5	230	324,50



<p>High-performance ventilation system adapted to continuous operation</p>		<p>Smooth work surface makes it easy to keep clean</p>	
<p>Glass touchscreen panel with dedicated timer</p>		<p>Housing made of stainless steel</p>	

**SOUS-VIDE GN 1/1 COOKING CIRCULATOR**

- ensures temperature stability with accuracy of 0.1°C
- built in pump
- protection against water level
- electronic control panel
- sealed lid
- tap for water drainage
- large capacity adapted to the needs of professional gastronomy kitchens

**caterina**



Code	W mm	D mm	H mm	P kW	U V	Price net (€)
<b>691250</b>	620	360	280	0,7	230	<b>650,00</b>

**SOUS-VIDE COOKING CIRCULATOR**

- ensures temperature stability with accuracy of 0.1°C
- temperature adjustment pitch by 0.1°C
- built-in pump allows even circulation of water
- protection against too low water level
- attachable in any containers with a flat or rounded edge
- designed for continuous operation

1500w



Code	Product	W mm	D mm	H mm	M kg	P kW	U V	Price net (€)
<b>691100</b>	Circulator	145	115	325	1,9	1,5	230	<b>347,00</b>

**VACUUM BAGS STAND**

- dedicated for packing unit for liquids, code 691312
- made out of stainless steel



Code	Price net (€)
<b>691251</b>	<b>48,87</b>

**INSULATING BALLS**

- reduce heat losses by up to 90%, replace the container lid by floating on water surface
- reduce water losses by limiting evaporation (particularly important in case of no water refilling)
- increase thermal stability
- reduce energy consumption



**UNIVERSAL TONGS**

- silicon-coated, do not damage the structure of sous-vide bags

SIL



Code	L mm	Price net (€)
<b>422302</b>	300	<b>7,55</b>
<b>422402</b>	400	<b>8,99</b>

Code	K pcs	Price net (€)
<b>691190</b>	100	<b>22,00</b>



*Classic*  
Cook

*Smart*  
Cook

## CONVECTION STEAM OVENS

Convection steam ovens are versatile appliances for professional kitchens to ensure the highest quality of prepared food.

GASTRONOMIC convection steam ovens

Stalgast ClassicCook..... 278

Stalgast SmartCook ..... 279-280

Accessories

for gastronomic ovens.....281-284



## CONVECTION STEAM OVENS

**14**  
**MODELS**

**Smart**  
Cook

**stalga**

Convection steam ovens  
**GASTRONOMIC**

### Manual control

- Manual control panel
- Humidity regulation from 0 to 100%
- Timer up to 120 minutes and non-stop mode
- Manual chimney control
- Fan reverse
- Internal LED lighting
- End of the cycle signalling
- Door switch
- Double safety glass
- Drip tray
- Safety thermostat
- Water connection  $\frac{3}{4}$ "
- Easy to clean
- Electric or gas ovens

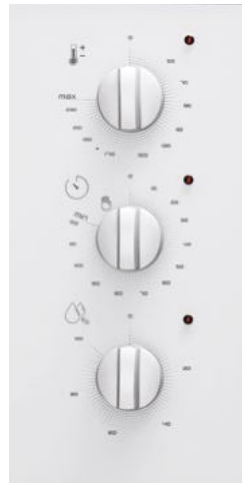

## Touchscreen control

- 5 or 7 inch touchscreen control panel
- Fan reverse
- End of cycle alarm
- Door switch
- Safety thermostat
- Internal LED lighting
- Water connection 3/4"
- Double, safety glass
- Clima Control - % humidity control
- 10-step fan speed control
- Steam control - programmable chimney
- 3 cooking modes: cooking, baking and steam cooking
- Multi-point probe, core probe (optional), vacuum probe (optional)
- Control of cooking with time, core probe or Delta T
- 120 programs with 6 cooking stages each
- AllOnTime
- MultiCook
- Regeneration / food temperature maintenance
- User configurable, cookbook with pictures
- Electric or gas version

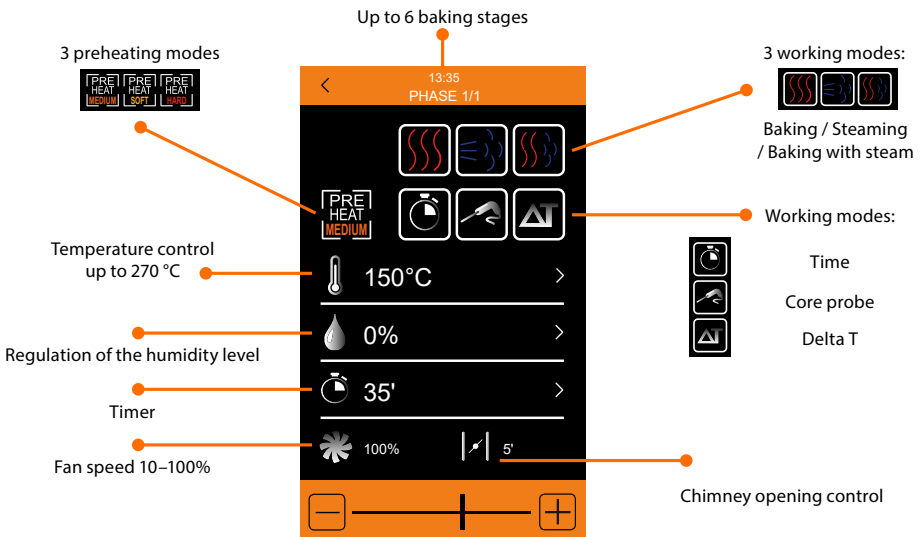
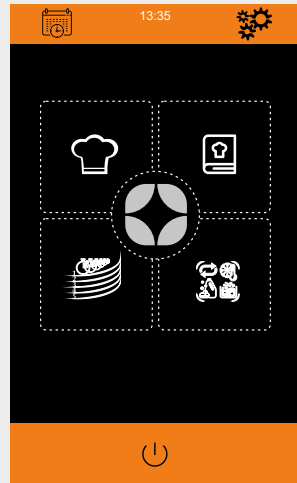

## Functions and equipmen



### MANUAL COOKING

Enables easy setting of the operating modes for any dishes, without the need to create a recipe. Simplifies the food preparation process.



### 120 PROGRAMS 6 STAGES EACH

The oven operates 120 programs in 6 stages.



### STEAM CONTROL

The technology enables precise humidity level adjustment inside the oven's chamber within the range from 0 to 100%, with fine adjustment of 5%.



### COOKBOOK

All ovens with touchscreen control have an installed cookbook. Line Stalgast SmartCook has easy to read cookbook. The book has as many as 72 recipes, divided into 8 groups. In addition, each dish has a photo, which improves the intuitiveness of the cook's work.



### FAN CONTROL

10 regulation levels of the fan operating with a reverse allow to prepare the most delicate dishes. Changing direction of fan rotation ensures even temperature distribution inside the chamber, even when fully loaded.

### HACCP

### HACCP DATA RECORD

The oven records the history of the operating modes and parameters of the device in the HACCP system (Hazard Analysis and Critical Control Points). One can easily save the report on a USB drive.



### CLIMA CONTROL

The chimney control enables fast lowering of the humidity level inside the chamber. Automatic chimney opening before the end of the operation of the device function is available which allows to achieve the desired level of baking.



### PREMIX GAS BURNER

Available in all gas stoves, new burner which lowers gas consumption. Its construction enables even temperature distribution inside the oven's chamber.



### DELTA T

Advanced mode which requires the use of the attached to the stove probe. It allows to maintain a constant temperature difference inside the product and the oven chamber. Slow baking lowers weight loss of the product and provides the perfect culinary effect.



### REGENERATION / TEMPERATURES MAINTENANCE

Regeneration allows to reheat previously prepared dishes, preserving taste and aesthetic qualities. Temperature maintenance allows delayed meals serving.



### MULTIPOINT PROBE

Enables the use of an additional probe to measure temperature in three different points (optional).



### PROOFING

This function is particularly often used in bakery and confectionery for control of dough proofing. Constant temperature during dough proofing ensures great pastries results.



### VACUUM PROBE

Provides the highest precision of temperature measurement inside of the food with the vacuum cooking technique SOUS-VIDE. 1.5 mm diameter thin probe is adapted for use with vacuum bags (optional).



### PLANNING

Delayed start function allows to save time. Scheduling device working hours allows to prepare long cooking dishes for desired time.





### FAST COOLING

Automatic cooling of the chamber to the desired temperature, so that one could start preparing the next dish faster.



### MULTIWASH

Depending on the level of dirt in the chamber there are 3 automatic washing programs available. The length of individual washing cycles is: 51', 81', 111'. **For ovens not equipped with automatic washing system, one can purchase a shower.**



### ALLONTIME

A mode that allows serving of many dishes at the same time. A clear signal will inform when the next products is to be added so that all the products were ready at the same time.



### MULTICOOK

The convection steam oven allows to prepare many products at the same time, without mixing flavours and aromas. The device can be loaded and unloaded continuously. The device will inform the user once a specific product is ready.



### MULTIPREHEAT

3 oven preheating modes: soft (+10 °C), medium (+20 °C), hard (+30 °C). Depending on how much the chamber is loaded it is possible to preheat the chamber to a higher temperature.



### SOUS-VIDE

A process of slow cooking in vacuum. This technology allow to retain the nutritional value, taste and aroma of the products. Sous-vide probe (additionally available) will help to maintain the optimal temperature of the prepared product in the oven.

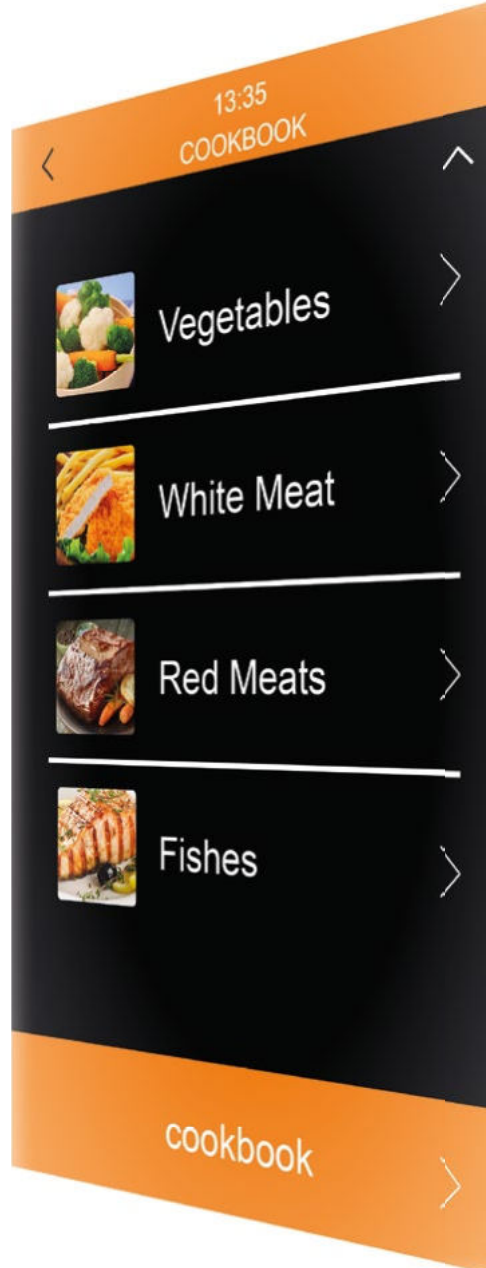

# Stalgast **ClassicCook** ovens



GN 1/1

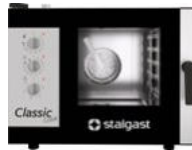

Code	9100043	9100045	9100049
Number of shelves	5 (GN 1/1)	7 (GN 1/1)	11 (GN 1/1)
Distance between guides	~ 67 mm	~ 67 mm	~ 67 mm
Dimensions (WxDxH)	790 x 860 x 690 mm	790 x 860 x 830 mm	790 x 860 x 1100 mm
Minimum temperature	50°C	50°C	50°C
Maximum temperature	250°C	250°C	250°C
Weight	52 kg	78 kg	106 kg
Power	Current	Current	Current
Electric power	7,75 kW	10,2 kW	18,5 kW
Voltage	400 V - 50/60 Hz	400 V - 50/60 Hz	400 V - 50/60 Hz
Price net (€)	<b>3800,70</b>	<b>5036,70</b>	<b>6478,70</b>



GN 1/1



Code	9100046	9100050
Number of shelves	7 (GN 1/1)	11 (GN 1/1)
Distance between guides	~ 67 mm	~ 67 mm
Dimensions (WxDxH)	790 x 960 x 850 mm	790 x 960 x 1120 mm
Minimum temperature	50°C	50°C
Maximum temperature	250°C	250°C
Weight	125 kg	140 kg
Power	Gas / Electricity	Gas / Electricity
Gas type	G20	G20
Gas power	14 kW	20 kW
Electric power	0,65 kW	0,65 kW
Voltage	230 V - 50/60 Hz	230 V - 50/60 Hz
Price net (€)	<b>9064,00</b>	<b>10042,50</b>

# Stalgast **SmartCook** ovens



Code	9100044	9100047	9100051
Number of shelves	5 (GN 1/1)	7 (GN 1/1)	11 (GN 1/1)
Distance between guides	~ 67 mm	~ 67 mm	~ 67 mm
Dimensions (WxDxH)	790 x 860 x 690 mm	790 x 860 x 830 mm	790 x 860 x 1100 mm
Minimum temperature	50°C	50°C	50°C
Maximum temperature	270°C	270°C	270°C
Weight	54 kg	78 kg	106 kg
Power	Current	Current	Current
Electric power	7,75 kW	10,2 kW	18,5 kW
Voltage	400 V - 50/60 Hz	400 V - 50/60 Hz	400 V - 50/60 Hz
Price net (€)	<b>6890,70</b>	<b>8641,70</b>	<b>10197,00</b>



Code	9100048	9100052
Number of shelves	7 (GN 1/1)	11 (GN 1/1)
Distance between guides	~ 67 mm	~ 67 mm
Dimensions (WxDxH)	790 x 960 x 850 mm	790 x 960 x 1120 mm
Minimum temperature	50°C	50°C
Maximum temperature	270°C	270°C
Weight	125 kg	140 kg
Power	Gas / Electricity	Gas / Electricity
Gas type	G20	G20
Gas power	14 kW	20 kW
Electric power	0,65 kW	0,65 kW
Voltage	230 V - 50/60 Hz	230 V - 50/60 Hz
Price net (€)	<b>12967,70</b>	<b>14275,80</b>

# Stalgast **SmartCook** ovens



GN 2/1



Code	9100053	9100055
Number of shelves	7 (GN 2/1)	11 (GN 2/1)
Distance between guides	~ 67 mm	~ 67 mm
Dimensions (WxDxH)	790 x 1280 x 830 mm	790 x 1280 x 1100 mm
Minimum temperature	50°C	50°C
Maximum temperature	270°C	270°C
Weight	120 kg	160 kg
Power	Electricity	Electricity
Electric power	14,2 kW	28,5 kW
Voltage	400 V - 50/60 Hz	400 V - 50/60 Hz
Price net (€)	<b>11124,00</b>	<b>13276,70</b>



GN 2/1

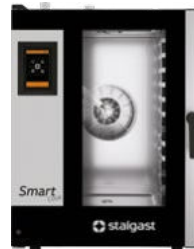

Code	9100054	9100056
Number of shelves	7 (GN 2/1)	11 (GN 2/1)
Distance between guides	~ 67 mm	~ 67 mm
Dimensions (WxDxH)	790 x 1280 x 850 mm	790 x 1280 x 1110 mm
Minimum temperature	50°C	50°C
Maximum temperature	270°C	270°C
Weight	145 kg	175 kg
Power	Gas / Electricity	Gas / Electricity
Gas type	G20	G20
Gas power	20 kW	28 kW
Electric power	0,65 kW	0,65 kW
Voltage	230 V - 50/60 Hz	230 V - 50/60 Hz
Price net (€)	<b>14461,20</b>	<b>15934,10</b>

## Accessories **GASTRONOMIC** ovens



### BASES

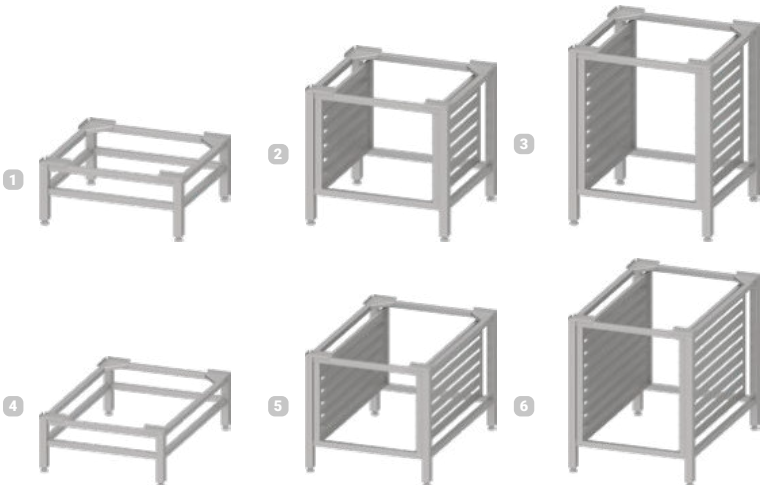

No.	Code	Compatible with	W mm	D mm	H mm	Price net (€)
1.	<b>9057931</b>	Gastronomic ovens GN 1/1	704	645	300	<b>300,00</b>
2.	<b>9057961</b>	Gastronomic ovens GN 1/1	704	645	650	<b>390,00</b>
3.	<b>9057981</b>	Gastronomic ovens GN 1/1	704	645	850	<b>420,00</b>
4.	<b>9057932</b>	Gastronomic ovens GN 2/1	704	1008	300	<b>300,00</b>
5.	<b>9057962</b>	Gastronomic ovens GN 2/1	704	1008	650	<b>400,00</b>
6.	<b>9057982</b>	Gastronomic ovens GN 2/1	704	1008	850	<b>440,00</b>

## CONVECTION STEAM OVENS

### HOOD

- the device includes: motor with exhaust fan, steam condenser
- connection exhaust outlet  $\varnothing$  120 mm

Code	Compatible with	W mm	D mm	H mm	Price net (€)
<b>9100581</b>	Gastronomic ovens GN 1/1, electric	790	840	275	<b>2956,10</b>
<b>9100583</b>	Ovens 9100053 and 9100055	790	1270	345	<b>3532,90</b>
<b>9100704</b>	2 Gastronomic ovens GN 1/1, electric	790	840	275	<b>3234,20</b>



### INSTALLATION KIT

Code	Product	Compatible with	Price net (€)
<b>9100434</b>	Installation kit for hydraulic connection of 1 convection steam oven	Stalgast ovens (dedicated to 1 oven only)	<b>324,45</b>
<b>9100671</b>	Installation kit for connection of 1 convection steam oven with a hood or steam condensate	Stalgast ovens (dedicated to 1 oven only)	<b>226,60</b>
<b>9100708</b>	Installation kit for hydraulic connection of 2 convection steam ovens without a hood	Stalgast ovens (dedicated to only 2 ovens)	<b>690,10</b>
<b>9100710</b>	Installation kit for connection of 2 convection steam ovens with a hood or a steam condenser	Stalgast ovens (dedicated to only 2 ovens)	<b>375,95</b>



### STACKING KIT

Code	Compatible with	W mm	D mm	H mm	Price net (€)
<b>9100586</b>	Gastronomic ovens GN 1/1, electric	788	758	78	<b>726,15</b>



### WATER PRESSURE REDUCER

- recommended for Stalgast ClassicCook ovens
- 3/4 inch connection
- 2 bar water pressure reducer



Code	Price net (€)
<b>9100018</b>	<b>57,68</b>

### PROBE

- dedicated to Stalgast ovens



Code	Product	Price net (€)
<b>9100376</b>	External sous-vide probe	<b>381,10</b>
<b>9100620</b>	External multi-point probe	<b>276,04</b>
<b>9100375</b>	External core probe	<b>280,16</b>



GRILL NON-STICK  
TRAY GN 1/1

Code	W mm	D mm	Price net (€)
917003	530	325	267,80



EGG & CAKE TRAY GN 1/1

Code	W mm	D mm	Price net (€)
917028	530	325	185,40



GRID FOR FRYING FRIES,  
VEGETABLES AND FISH GN 1/1

Code	W mm	D mm	Price net (€)
917034	530	325	247,20



BAKING TRAY ENAMELED  
GN 1/1

Code	W mm	D mm	Price net (€)
917036	530	325	154,50



GRILL GRID 1/1 GN

Code	W mm	D mm	Price net (€)
917037	530	325	262,65



INOX

GN 1/1

Code	W mm	D mm	H mm	V liters	Price net (€)
111042	530	325	40	5,0	29,00
111062	530	325	65	8,8	32,00



NON-STICK FRYING TRAY

Code	W mm	D mm	H mm	V liters	Price net (€)
171020	530	325	20	2,5	42,50



ENAMELED FRYING TRAY

Code	W mm	D mm	H mm	V liters	Price net (€)
101021	530	325	20	2,2	14,20



FULL ENAMELED BAKING TRAY

Code	W mm	D mm	H mm	V liters	Price net (€)
101041	530	325	40	5,0	16,90



INOX

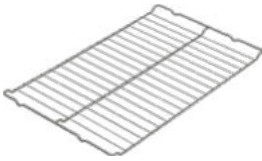

**STAINLESS STEEL GRILL**

Code	Description	W mm	D mm	Cena netto
<b>103114</b>	GN 1/1	530	325	<b>12,60</b>

INOX

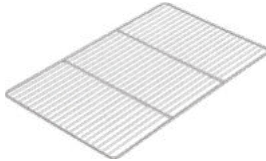

**STAINLESS STEEL GRILL**

• GN offer p. 222-228

Code	Description	W mm	D mm	Cena netto
<b>103115</b>	GN 1/1	530	325	<b>18,20</b>

INOX

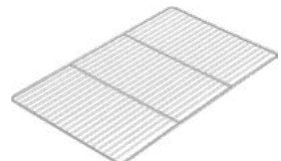

**GRID FOR CHICKEN**

Code	W mm	D mm	Price net (€)
<b>103644</b>	600	400	<b>24,70</b>

Al



**BAKING SHEET**

- solid sheet, 3 lipping edges
- thickness: 911101 - 1,5 mm, 911102 - 2 mm

Code	W mm	D mm	Price net (€)
<b>911101</b>	600	400	<b>26,00</b>
<b>911102</b>	600	400	<b>31,00</b>

Al



**BAKING SHEET**

- perforated sheet, 3 lipping edges
- thickness: 1,5 mm

Code	W mm	D mm	Price net (€)
<b>911201</b>	600	400	<b>29,20</b>

Al



**BAKING SHEET**

- perforated sheet, silicone-coated
- 3 lipping edges
- thickness: 1,5 mm

Code	W mm	D mm	Price net (€)
<b>911211</b>	600	400	<b>46,00</b>

**SHOWER KIT**



Code	L mm	Price net (€)
<b>651202</b>	2000	<b>75,00</b>



Discover a perfect  
convection oven for your  
business!





# COOLING

All kinds of refrigeration and freezing equipment that is an essential equipment element for any type of catering establishment, ensuring the proper storage of food.

Refrigerators and freezers .....	288-289, 302-304
Salad refrigerated counters, cooling tops .....	293-295, 300
Refrigerated and freezing counters.....	290-292, 296-297

Display cases .....	298-299
Refrigeration 600x400 .....	300
Bar tables and display cabinets. ....	305-309
Accessories for refrigerated cabinets and tables .....	308
Chest freezers, shock coolers.....	309-311

## DESCRIPTION OF ADDITIONAL MARKINGS FOR THE COOLING CHAPTER:



Refrigeration appliance



Freezing appliance



or



and



Static system



Dynamic system



For confectionery/bakery trays



For gastronomic containers



For gastronomic containers



Opens from both sides



Hinged doors



Sliding doors

## TYPES OF COOLING SYSTEMS:

**Static** (the so-called gravitational cooling), where warmer and, therefore, thinner air layers accumulate in the upper part of the appliance, while the cooler ones fall down (making the lower shelves always cooler than the upper ones). Stalgast static appliances use a **mixing fan** (to facilitate movement) in the compartment to equalize the preset temperature.

**Dynamic** (the so-called forced cooling), where the air circulation ensures quick cooling of freshly placed products and even distribution of low temperature inside the device. Special mechanism stops the ventilation when the door is opened, which prevents hot air from flowing in, allowing the food to maintain a constant temperature.

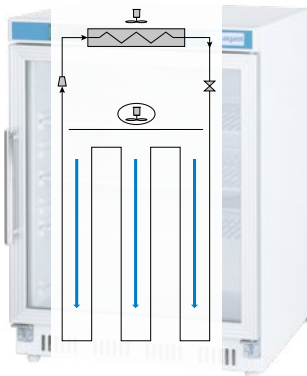

static system diagram

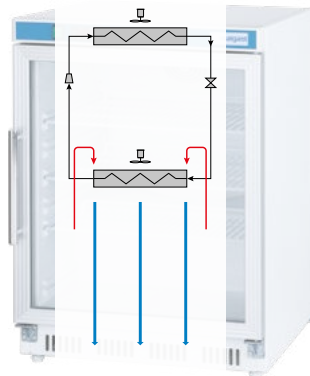

dynamic system diagram

## REFRIGERATORS & FREEZERS



- refrigerants used: R290 and R600a
- housing and compartment made of stainless steel (INOX marking) or white powder-coated sheet
- fitted with forced air circulation
- automatic defrosting
- electronic controller with temperature display
- self-closing door
- adjustable feet (+45 mm)
- profiled handle for convenient opening
- door lock
- valve face heaters in the freezing cabinet



### WHEELED REFRIGERATOR / FREEZER, ONE DOOR

- front wheels equipped with a brake
- lighting
- automatic condensate evaporation
- 3 shelves GN 2/1 with a set of guide rails
- 20 levels for guide rails
- insulation thickness 60 mm
- dedicated guide rails - Code 830644
- dedicated shelves - Code 830645
- front wheels equipped with a brake



No.	Code	W mm	D mm	H mm	T °C	P kW	U V	Energy class	Energy consumption kWh/year	V liters	V liters net	Climate class	Price net (€)
1.	<b>830590</b>	680	810	2010	-2 / +8	0,17	230	D	671	600	383	4	<b>1629,00</b>
2.	<b>830620</b>	740	830	2010	-2 / +8	0,21	230	D	1015	650	465	4	<b>1759,00</b>
	<b>830621</b>	740	830	2010	-18 / -22	0,48	230	D	2351	650	465	4	<b>2174,00</b>



### FREEZER, TWO DOORS

- lighting
- automatic condensate evaporation
- 6 shelves GN 2/1 with a set of guide rails
- 21 levels for guide rails
- insulation thickness 70 mm
- dedicated guide rails - Code 840643
- front wheels equipped with a brake



No.	Code	W mm	D mm	H mm	T °C	P kW	U V	Energy class	Energy consumption kWh/year	V liters	V liters net	Climate class	Price net (€)
1.	<b>830130</b>	1480	830	2010	-2 / +8	0,44	230	D	1517	1300	1185	4	<b>2836,00</b>
2.	<b>830145</b>	1480	830	2010	-18 / -22	0,78	230	C	3259	1300	1185	4	<b>3230,00</b>

### REFRIGERATOR-FREEZER, ONE DOOR

- 4 shelves included
- insulation thickness 60 mm
- 2 independent compartments and aggregates
- dedicated guide rails - code 840644
- dedicated shelves - code 840645



Code	W mm	D mm	H mm	T °C	P kW	U V	V liters	Price net (€)
<b>840602</b>	680	845	2000	-2/8 / -10/-20	0,25/0,3	230	128,5/128,5	<b>2583,00</b>



### REFRIGERATOR / FREEZER, ONE DOOR

- 3 shelves included
- 21 levels for guide rails
- insulation thickness 60 mm
- dedicated guide rails - code 840644
- dedicated shelves - code 840645



Code	W mm	D mm	H mm	T °C	P kW	U V	Energy class	Energy consumption kWh/year	V liters	V liters net	Climate class	Price net (€)
<b>880700</b>	680	810	2000	-2 / +8	0,35	230	C	434	537	376	4	<b>1562,00</b>



### REFRIGERATOR / FREEZER, TWO DOORS

- 6 shelves included
- 21 levels for guide rails
- insulation thickness 60 mm
- dedicated guide rails - code 840644
- dedicated shelves - code 840645



Code	W mm	D mm	H mm	T °C	P kW	U V	Energy class	Energy consumption kWh/year	V liters	V liters net	Climate class	Price net (€)
<b>881400</b>	1340	845	2000	-2 / +8	0,45	230	C	675	1173	770	4	<b>2016,00</b>



## REFRIGERATED & FREEZING COUNTERS



- refrigerants used: R290 and R600a
- housing and compartment made of stainless steel (INOX marking)
- fitted with forced air circulation
- automatic defrosting and automatic condensate evaporation
- electronic controller with temperature display
- adjustable feet
- distance between guide rails 50 mm



### REFRIGERATED OR FREEZING COUNTER

- 2 shelves compartment in GN 1/1 standard
- insulation thickness 50 mm
- 13 levels for guide rails
- dedicated guide rails - code 831443
- dedicated shelves - code 831445



Code	Description	W mm	D mm	H mm	T °C	P kW	U V	Energy class	Energy consumption kWh/year	V liters	V liters net	Climate class	Price net (€)
<b>831026</b>	2-door refrigeration	1360	700	850	-2 / +8	0,21	230	C	919	282	220	4	<b>1705,00</b>
<b>831027</b>	2-door freezing	1360	700	850	-18 / -22	0,52	230	D	2420	282	187	4	<b>2200,00</b>

### REFRIGERATED OR FREEZING COUNTER

- 3 shelves compartment in GN 1/1 standard
- insulation thickness 50 mm
- 13 levels for guide rails
- dedicated guide rails - code 831443
- dedicated shelves - code 831445



Code	Description	W mm	D mm	H mm	T °C	P kW	U V	Energy class	Energy consumption kWh/year	V liters	V liters net	Climate class	Price net (€)
<b>831036</b>	3-door refrigeration	1795	700	850	-2 / +8	0,23	230	C	1145	417	341	4	<b>1997,00</b>
<b>831037</b>	3-door freezing	1795	700	850	-18 / -22	0,56	230	D	3100	417	312	4	<b>2480,00</b>



### REFRIGERATED COUNTER

- 2 shelves compartment in GN 1/1 standard
- insulation thickness 35 mm
- 8 levels for guide rails
- dedicated guide rails - code 831443
- dedicated shelves - code 831445



Code	W mm	D mm	H mm	T °C	P kW	U V	Energy class	Energy consumption kWh/year	V liters	V liters net	Climate class	Price net (€)
<b>832029</b>	900	700	875	+2 / +8	0,17	230	C	830	240	198	4	<b>1012,00</b>

### REFRIGERATED COUNTER

- 3 shelves compartment in GN 1/1 standard
- insulation thickness 35 mm
- 8 levels for guide rails
- dedicated guide rails - code 831443
- dedicated shelves - code 831445



Code	W mm	D mm	H mm	T °C	P kW	U V	Energy class	Energy consumption kWh/year	V liters	V liters net	Climate class	Price net (€)
<b>832039</b>	1365	700	875	-2 / +8	0,24	230	C	1294	368	297	4	<b>1453,00</b>



**FREEZING COUNTER**

- 2 shelves with guide rails included
- dust filter
- insulation thickness 60 mm
- dedicated guide rails - code 841443



Code	W mm	D mm	H mm	T °C	P kW	U V	Energy class	Energy consumption kWh/year	V liters	V liters net	Climate class	Price net (€)
<b>842045</b>	943	700	850	-10 / -20	0,26	230	D	2537	257	201	4	<b>1832,00</b>



**REFRIGERATED COUNTER WITH GLASS DOOR**

- 2 shelves with dimensions: 325x430 mm
- lighting
- insulation thickness 50 mm
- dust filter



Code	W mm	D mm	H mm	T °C	P kW	U V	Energy class	Energy consumption kWh/year	V liters	V liters net	Climate class	Price net (€)
<b>831126</b>	1360	600	850	+2 / +8	0,215	230	B	880	228	228	4	<b>1849,00</b>



**REFRIGERATED COUNTER**

- 4 drawers compartment in GN 1/1 standard
- insulation thickness 35 mm



Code	W mm	D mm	H mm	T °C	P kW	U V	Energy class	Energy consumption kWh/year	V liters	V liters net	Climate class	Price net (€)
<b>832041</b>	900	700	875	+2 / +8	0,17	230	C	830	220	198	4	<b>1827,00</b>

## REFRIGERATED SALAD COUNTERS



- refrigerants used: R290 and R600a
- housing and chamber made of stainless steel
- automatic defrosting and automatic condensate evaporation
- electronic controller with temperature display
- self-closing door with an opening lock
- maximum height of GN containers 150mm
- 8 levels for guide rails
- insulation thickness 35 mm
- distance between guide rails 50 mm
- table prices do not include containers

### REFRIGERATED SALAD COUNTER

- 2 shelves compartment in GN 1/1 standard
- hinged cover in the adapter
- stainless steel work tabletop
- dedicated guide rails - code 831443
- dedicated shelves - code 831445



Code	Container layout	W mm	D mm	H mm	T °C	P kW	U V	V liters	Price net (€)
<b>832328</b>	5 x GN 1/6	900	700	1000	+2 / +8	0,17	230	240	<b>1219,00</b>

### REFRIGERATED SALAD COUNTER

- 2 shelves compartment in GN 1/1 standard
- cutting board made of polypropylene
- dedicated guide rails - code 831443
- dedicated shelves - code 831445



Code	Container layout	W mm	D mm	H mm	T °C	P kW	U V	V liters	Price net (€)
<b>832225</b>	8 x GN 1/4	1360	700	1365	-2 / +8	0,23	230	240	<b>2140,00</b>

REFRIGERATED SALAD COUNTER

- 2 shelves GN 1/1
- cutting board made of polypropylene
- dedicated guide rails - code 831443
- dedicated shelves - code 831445



Code	Container layout	W mm	D mm	H mm	T °C	P kW	U V	V liters	Price net (€)
<b>832129</b>	10 x GN 1/4	900	705	875	+2 / +8	0,17	230	240	<b>994,00</b>

REFRIGERATED SALAD COUNTER

- 3 shelves compartment in GN 1/1 standard
- cutting board made of polypropylene
- dedicated guide rails - code 831443
- dedicated shelves - code 831445



Code	Container layout	W mm	D mm	H mm	T °C	U V	V liters	Price net (€)
<b>832139</b>	16 x GN 1/4	1365	700	875	-2 / +8	230	368	<b>1570,00</b>

## REFRIGERATED SALAD COUNTER

- 2 shelves compartment in GN 1/1 standard
- cutting board made of polypropylene
- dedicated guide rails - code 831443
- dedicated shelves - code 831445



Code	Container layout	W mm	D mm	H mm	T °C	P kW	U V	V liters	Price net (€)
<b>832222</b>	10 x GN 1/4	900	705	1300	+2 / +8	0,24	230	240	<b>1409,00</b>

## REFRIGERATED SALAD COUNTER

- 3 shelves compartment in GN 1/1 standard
- cutting board made of polypropylene
- dedicated guide rails - code 831443
- dedicated shelves - code 831445



Code	Container layout	W mm	D mm	H mm	T °C	P kW	U V	V liters	Price net (€)
<b>832232</b>	16 x GN 1/4	1365	705	1300	+2 / +8	0,24	230	368	<b>1692,00</b>

## REFRIGERATED AND FREEZING PIZZA COUNTERS



- refrigerants used: R290 and R600a
- electronic controller with temperature display
- automatic defrosting
- maximum height of GN containers 150 mm (price does not include containers)
- table housing and chamber made of stainless steel
- self-closing door with open door lock
- tables fitted with automatic condensate evaporation

### REFRIGERATED PIZZA COUNTER WITH DISPLAY CASE

- 3 shelves compartment in GN 1/1 standard
- dedicated guide rails - code 831443
- dedicated shelves - code 831445



Code	Container layout	W mm	D mm	H mm	T °C	P kW	U V	V liters	Price net (€)
<b>833037</b>	8 x GN 1/6	1365	700	1090	+2 / +8	0,24	230	402	<b>1724,00</b>



## REFRIGERATED PIZZA COUNTER ON WHEELS

- top made of granite
- 3 shelves compartment in GN 1/1 standard
- insulation thickness 35 mm
- dedicated guide rails - code 831443
- dedicated shelves - code 831445



For cooling tops see pages 471-473



Code	W mm	D mm	H mm	T °C	P kW	U V	Energy class	Energy consumption kWh/year	V liters	V liters net	Climate class	Price net (€)
<b>833031</b>	1400	700	1120	+2 / +8	0,24	230	D	1294	368	297	4	<b>1697,00</b>

## REFRIGERATED PIZZA COUNTER

- top made of granite
- 2 shelves compartment in GN 1/1 standard
- insulation thickness 35 mm
- dedicated guide rails - code 831443
- dedicated shelves - code 831445



Code	Container layout	W mm	D mm	H mm	T °C	P kW	U V	V liters	Price net (€)
<b>833029</b>	5 x GN 1/6	900	700	1090	+2 / +8	0,17	230	240	<b>1163,00</b>



REFRIGERATED DISPLAY CASE



GN 1/3



Code	Container layout	W mm	D mm	H mm	T °C	P kW	U V	Price net (€)
<b>834430</b>	4 x GN 1/3	1200	395	440	+2 / +8	0,11	230	<b>749,00</b>

REFRIGERATED DISPLAY CASE



GN 1/3  
GN 1/4



Code	Container layout	W mm	D mm	H mm	T °C	P kW	U V	Price net (€)
<b>834630</b>	6 x GN 1/3	1400	395	440	+2 / +8	0,11	230	<b>769,00</b>
<b>834631</b>	6 x GN 1/3	1500	395	440	+2 / +8	0,11	230	<b>810,00</b>
<b>834641</b>	6 x GN 1/4	1400	335	440	+2 / +8	0,11	230	<b>673,00</b>

REFRIGERATED DISPLAY CASE



GN 1/4



Code	Container layout	W mm	D mm	H mm	T °C	P kW	U V	Price net (€)
<b>844741</b>	7 x GN 1/4	1600	335	427	+2 / +8	0,11	230	<b>856,90</b>

REFRIGERATED DISPLAY CASE



GN 1/3  
GN 1/4

Code	Container layout	W mm	D mm	H mm	T °C	P kW	U V	Price net (€)
<b>834730</b>	7 x GN 1/3	1600	395	440	+2 / +8	0,11	230	<b>880,00</b>
<b>834541</b>	7 x GN 1/4	1500	335	440	+2 / +8	0,11	230	<b>750,00</b>
<b>834741</b>	7 x GN 1/4	1600	335	440	+2 / +8	0,11	230	<b>760,00</b>

REFRIGERATED DISPLAY CASE



GN 1/4

Code	Container layout	W mm	D mm	H mm	T °C	P kW	U V	Price net (€)
<b>834840</b>	8 x GN 1/4	1800	335	440	+2 / +8	0,11	230	<b>760,00</b>

REFRIGERATED DISPLAY CASE



GN 1/3

Code	Container layout	W mm	D mm	H mm	T °C	P kW	U V	Price net (€)
<b>834930</b>	9 x GN 1/3	2000	395	440	+2 / +8	0,11	230	<b>970,00</b>

REFRIGERATED DISPLAY CASE



GN 1/4

Code	Container layout	W mm	D mm	H mm	T °C	P kW	U V	Price net (€)
<b>834141</b>	10 x GN 1/4	2000	335	440	+2 / +8	0,11	230	<b>900,00</b>

REFRIGERATED PIZZA COUNTER 600X400

- top made of granite
- 7 neutral drawers
- wheels
- dedicated display case - code 834541



For cooling tops see pages 471-473



Code	W mm	D mm	H mm	T °C	U V	V liters	Price net (€)
<b>833310</b>	1510	800	1000	-2/+8	230	390	<b>2520,00</b>

REFRIGERATED PIZZA COUNTER 600X400

- top made of granite
- 7 neutral drawers
- wheels
- dedicated display case - code 834141



For cooling tops see pages 471-473



Code	W mm	D mm	H mm	T °C	U V	V liters	Price net (€)
<b>833271</b>	2025	800	1000	-2/+8	230	580	<b>2680,00</b>

## REFRIGERATED AND FREEZING CABINETS AND DISPLAY CABINETS



- refrigerants used: R290 and R600a
- silent generator
- built-in key lock
- electronic controller with temperature display

### REFRIGERATED OR FREEZING DISPLAY CABINET

- illuminated advertising panel
- appliance made of powder coated sheet metal (white)
- LED lighting in doors
- automatic defrosting
- 5 shelves included WxD: 460x550 mm
- additional shelf - code 840648



Code	W mm	D mm	H mm	T °C	P kW	U V	V liters	Energy class	Energy consumption kWh/year	Price net (€)
<b>850011</b>	680	700	1990	-18 / -22	0,85	230	420	D	4015	<b>2230,20</b>

### REFRIGERATED DISPLAY CABINET

- appliance made of powder coated sheet metal (white)
- automatic defrosting
- 4 shelves included WxD: 3 pcs 652x530 mm, 1 pc 652x211 mm
- shelf load capacity - 8 kg
- additional shelf - code 880645



Code	W mm	D mm	H mm	T °C	P kW	U V	V liters	Energy class	Energy consumption kWh/year	Price net (€)
<b>880604</b>	775	695	1900	+2 / +8	0,13	230	469	B	820	<b>1490,00</b>



**REFRIGERATED DISPLAY CABINET**

- appliance made of powder coated sheet metal (white)
- automatic defrosting
- 4 shelves included WxD:  
3 pcs 502x440 mm, 1 pc 502x201 mm
- shelf load capacity 8 kg
- additional shelf - code 880245



Code	W mm	D mm	H mm	T °C	P kW	U V	V liters	Energy class	Energy consumption kWh/year	Price net (€)
<b>880402</b>	600	600	1850	+2 / +8	0,13	230	258	B	773	<b>1037,00</b>

**REFRIGERATED OR FREEZING CABINET**

- appliance made of powder coated sheet metal (white)
- shelf load capacity up to 8 kg
- cooling cabinet 880600 - automatic defrosting
- freezer cabinet 880601 - 7 freezer shelves (manual defrosting)
- shelf dimensions WxD:  
model 880600 - 3 pcs 652x530 mm, 1 pc 652x211 mm  
model 880601 - 655x515 mm
- refrigerated display cabinet with 4 shelves included
- additional shelf for 880600 - code 880645



Code	W mm	D mm	H mm	T °C	P kW	U V	Energy class	Energy consumption kWh/year	V liters	V liters net	Climate class	Price net (€)
<b>880600</b>	775	695	1900	0 / +8	0,13	230	C	672	620	476	4	<b>1271,00</b>
<b>880601</b>	775	695	1900	-10 / -18	0,3	230	B	989	620	469	4	<b>1380,00</b>

**REFRIGERATED OR FREEZING CABINET**

- appliance made of powder coated sheet metal (white)
- cooling cabinet 880400 - automatic defrosting
- freezer cabinet 880401 - 7 freezer shelves (manual defrosting)
- shelf dimensions WxD:  
model 880400 - 3 pcs 502x440 mm, 1 pc 502x211 mm  
model 880401 - 480x410 mm
- refrigerated display cabinet with 4 shelves included
- additional shelf for 880400 - Code 880245
- internal parameters WxDxH: 510x485x1620 mm



Code	W mm	D mm	H mm	T °C	P kW	U V	Energy class	Energy consumption kWh/year	V liters	V liters net	Climate class	Price net (€)
<b>880400</b>	600	600	1850	0 / +8	0,13	230	C	478	361	265	4	<b>926,00</b>
<b>880401</b>	600	600	1850	-10 / -18	0,15	230	B	894	361	258	4	<b>1026,00</b>

**REFRIGERATED OR FREEZING CABINET**

- appliance made of powder coated sheet metal (white)
- cooling cabinet 880173 - automatic defrosting
- freezer cabinet 880174 - freezer shelves (manual defrosting)
- shelf dimensions WxD:  
model 880173 - 2 pcs 502x440 mm, 1 pc 502x211 mm  
model 880174 - 485x410 mm
- refrigerated display cabinet with 4 shelves included
- shelf load capacity 8 kg
- additional shelf for 880173 - code 880245



Code	W mm	D mm	H mm	T °C	P kW	U V	Energy class	Energy consumption kWh/year	V liters	V liters net	Climate class	Price net (€)
<b>880173</b>	600	585	855	0 / +8	0,1	230	A	409	129	78	4	<b>636,00</b>
<b>880174</b>	600	585	855	-10 / -18	0,11	230	A	511	129	78	4	<b>708,00</b>

**REFRIGERATED OR FREEZING CABINET**

- appliance housing made of stainless steel
- shelf load capacity up to 8 kg
- cooling cabinet 880602 - automatic defrosting
- freezer cabinet 880603 - 7 freezer shelves (manual defrosting)
- shelf dimensions WxD:  
model 880602 - 3 pcs 652x530 mm, 1 pc 652x211 mm  
model 880603 - 655x515 mm
- refrigerated display cabinet with 4 shelves included
- additional shelf for 880602 - code 880645
- model 880602 - cabinet interior made of plastic



Code	W mm	D mm	H mm	T °C	P kW	U V	Energy class	Energy consumption kWh/year	V liters	V liters net	Climate class	Price net (€)
<b>880602</b>	775	695	1900	0 / +8	0,13	230	C	672	620	476	4	<b>1470,00</b>
<b>880603</b>	775	695	1900	-10 / -18	0,3	230	B	989	620	469	4	<b>1580,00</b>

**REFRIGERATED OR FREEZING CABINET**

- appliance housing made of stainless steel
- cooling cabinet 880405 - automatic defrosting
- freezer cabinet 880406 - 7 freezer shelves (manual defrosting)
- shelf dimensions WxD:  
model 880405 - 3 pcs 652x530 mm, 1 pc 652x211 mm  
model 880603 - 480x410 mm
- refrigerated display cabinet with 4 shelves included
- additional shelf for 880405 - code 880245



Code	W mm	D mm	H mm	T °C	P kW	U V	Energy class	Energy consumption kWh/year	V liters	V liters net	Climate class	Price net (€)
<b>880405</b>	600	600	1850	0 / +8	0,13	230	C	478	361	265	4	<b>1153,00</b>
<b>880406</b>	600	600	1850	-10 / -18	0,15	230	B	894	361	258	4	<b>1254,00</b>

**REFRIGERATED OR FREEZING CABINET**

- appliance housing made of stainless steel
- freezer cabinet 880176 - freezer shelves (manual defrosting)
- shelf dimensions WxD:  
model 880175 - 2 pcs 502x440 mm, 1 pc 502x211 mm  
model 880176 - 485x410 mm
- refrigerated display cabinet with 3 shelves included
- shelf load capacity - 8 kg
- additional shelf for 880175 - code 880245



Code	W mm	D mm	H mm	T °C	P kW	U V	Energy class	Energy consumption kWh/year	V liters	V liters net	Climate class	Price net (€)
<b>880175</b>	600	585	855	0 / +8	0,1	230	A	409	129	78	4	<b>726,00</b>
<b>880176</b>	600	585	855	-10 / -18	0,105	230	A	511	129	78	4	<b>800,00</b>



### REFRIGERATED DISPLAY CABINET

- LED lighting
- climate zone 6 (up to +27°C/relative humidity 70%)
- 3 round glass shelves
- stainless steel housing



Code	Ø mm	W mm	V liters	T °C	M kg	P kW	U V	Energy class	Energy consumption kWh/year	Climate class	Price net (€)
<b>852160</b>	480	1030	100	-2/8	50	0,21	230	C	1376	6	<b>986,00</b>



### REFRIGERATED DISPLAY CABINET

- through display case
- lighting
- 3 adjustable shelves included
- automatic defrosting



Code	W mm	D mm	H mm	V liters	T °C	P kW	U V	Energy class	Energy consumption kWh/year	Price net (€)
<b>852180</b>	429	425	980	86	0 / +12	0,16	230	C	1184	<b>581,00</b>



### REFRIGERATED DISPLAY CABINET

- lighting
- 4 adjustable shelves included WxD: 460x385 mm



Code	W mm	D mm	H mm	V liters	T °C	P kW	U V	Energy class	Energy consumption kWh/year	Price net (€)
<b>852230</b>	515	485	1689	235	0 / +12	0,25	230	B	1622	<b>1083,00</b>



REFRIGERATED DISPLAY CABINET

- LED lighting
- 2 adjustable shelves included
- condensate drip tray



Code	W mm	D mm	H mm	V liters	T °C	P kW	U V	Energy class	Energy consumption kWh/year	Price net (€)
<b>852120</b>	702	568	686	120	0/+12	0,16	230	B	1141	<b>864,00</b>

REFRIGERATED DISPLAY CABINET

- LED lighting
- 2 adjustable shelves included
- condensate drip tray



No.	Code	Colour	W mm	D mm	H mm	V liters	T °C	P kW	U V	Energy class	Energy consumption kWh/year	Price net (€)
1.	<b>852103</b>	○	682	450	675	100	0/+12	0,16	230	B	912	<b>648,00</b>
2.	<b>852104</b>	●	682	450	675	100	0/+12	0,16	230	B	912	<b>648,00</b>

REFRIGERATED DISPLAY CABINET

- lighting
- 3 adjustable shelves included
- automatic defrosting 852174, 852145 - LED lighting



No.	Code	Colour	W mm	D mm	H mm	V liters	T °C	P kW	U V	Energy class	Energy consumption kWh/year	Price net (€)
1.	<b>852170</b>	○	428	386	960	78	0/+12	0,16	230	C	1003	<b>475,00</b>
2.	<b>852171</b>	●	428	386	960	78	0/+12	0,16	230	C	1003	<b>471,45</b>
3.	<b>852174</b>	●	428	386	960	78	0/+12	0,16	230	C	1003	<b>499,00</b>

## BAR CABINETS, DISPLAY CABINETS

- refrigerants used: R290 and R600a
- automatic defrosting and automatic condensate evaporation
- electronic controller with temperature display
- self-closing door with open door lock
- glass door



### REFRIGERATED BOTTLE DISPLAY CABINET

- powder coated housing (black)
- 1 door (opened)
- lighting
- 2 shelves included



Code	W mm	D mm	H mm	T °C	P kW	U V	V liters	Energy class	Energy consumption kWh/year	Price net (€)
<b>882151</b>	600	535	870	+2 / +8	0,105	230	129	B	627	<b>735,00</b>

### REFRIGERATED BOTTLE DISPLAY CABINET

- powder coated housing (black)
- 2 doors (sliding)
- lighting
- 8 shelves included



Code	W mm	D mm	H mm	T °C	P kW	U V	V liters	Energy class	Energy consumption kWh/year	Price net (€)
<b>882171</b>	920	520	1872	+2 / +8	0,25	230	490	C	1765	<b>1897,00</b>

# ACCESSORIES FOR REFRIGERATED / FREEZING COUNTERS AND CABINETS

**NEW**

## MODULE OF 2 DRAWERS FOR REFRIGERATED TABLES GN 1/1

- module with 2 drawers installed in place of the door
- 831000 - dedicated for use with models of refrigerated tables GN 1/1 with an aggregate on the side of the table
- 831001 - dedicated for use with models of refrigerated tables GN 1/1 with an aggregate at the bottom of the table



No.	Code	Drawer size	Price net (€)
1.	<b>831000</b>	304 x 525 x 140 mm	<b>399,00</b>
2.	<b>831001</b>	304 x 525 x 90 mm	<b>349,00</b>

## GUIDE RAILS FOR CABINETS AND COUNTERS

- guide rails sold in sets (1 set = 2 guide rails)
- price per set



Code	Product	W mm	D mm	L mm	Price net (€)
<b>830644</b>	Set of guide rails for cabinets GN 2/1	-	-	-	<b>31,00</b>
<b>840644</b>	Set of guide rails for cabinets GN 2/1	20	15	650	<b>24,32</b>
<b>831443</b>	Set of guide rails for counters GN 1/1	-	-	-	<b>43,00</b>

## SHELVES FOR CABINETS AND COUNTERS

- plasticized steel shelves

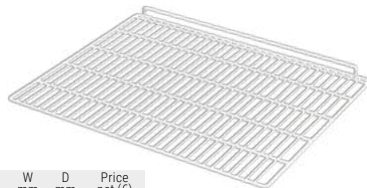

Code	Product	W mm	D mm	Price net (€)
<b>830645</b>	Shelf for cabinets GN 2/1	-	-	<b>25,00</b>
<b>831445</b>	Shelf for counters GN 1/1	-	-	<b>24,00</b>
<b>840151</b>	Shelf for display cabinet 882151	410	320	<b>14,16</b>
<b>880245</b>	Shelf for cabinets 880173, 880175, 880400, 880402, 880405	500	400	<b>16,00</b>
<b>880645</b>	Shelf for cabinets 880600, 880602, 880604	650	525	<b>17,39</b>
<b>840645</b>	Shelf for cabinets GN 2/1	530	650	<b>16,92</b>
<b>103644</b>	Shelf for devices with a compartment of 600x400 mm	600	400	<b>24,70</b>

## BLAST CHILLERS AND FREEZERS



- refrigerants used: R290 and R600a
- electronic controller with temperature display
- rounded corners of the cooling compartment for easy cleaning
- forced air circulation
- automatic switching to cooling mode
- adjustable feet
- allows using GN 1/1 and 400x600 trays

**BLAST CHILLER/FREEZER** are devices designed for quick cooling or freezing of prepared dishes.

### Blast CHILLING:

from +70°C to +3°C in 90 minutes

### Blast FREEZING:

from +70°C to -18°C in 240 minutes



### BLAST CHILLER

Code	W mm	D mm	H mm	Capacity GN	P kW	U V	Price net (€)
<b>849033</b>	750	750	770	3	1,15	230	<b>3190,00</b>
<b>849053</b>	750	750	890	5	1,43	230	<b>3560,00</b>
<b>849073</b>	750	750	1260	7	1,49	230	<b>5790,00</b>
<b>849103</b>	750	750	1260	10	1,49	230	<b>5900,00</b>

## CHEST FREEZERS



- R600a refrigerant
- powder coated housing (white)
- manual controller with adjustable cooling capacity from 1-7
- LED chamber lighting
- 1 basket and 1 partition included
- thick insulation walls
- manual defrost
- cover handle with closure function
- the dimensions include the handle and the hinge



### CHEST FREEZER

No.	Code	W mm	D mm	H mm	T °C	P kW	U V	V liters	Wheels pcs	Price net (€)
1.	<b>883101</b>	580	620	845	-18	0,105	230	93	2	<b>307,20</b>
2.	<b>883301</b>	1120	700	845	-18	0,130	230	282	2	<b>576,00</b>
3.	<b>883401</b>	1280	790	825	-18	0,110	230	354	4	<b>760,00</b>
4.	<b>883501</b>	1660	790	825	-18	0,125	230	488	6	<b>986,00</b>





## CHEST FREEZERS

- R600a refrigerant
- powder coated housing (white)
- manual controller with adjustable cooling capacity
- digital temperature display
- LED chamber lighting
- 2 basket and 1 partition included  
(883295 - 1 basket and 1 partition included)
- lid with closure function

**NEW**



### CHEST FREEZER

No.	Code	W mm	D mm	H mm	V liters	T °C	M kg	P kW	U V	Price net (€)
1.	<b>883402</b>	1316	743	840	395	-24	50,5	0,15	230	<b>1004,04</b>
2.	<b>883502</b>	1492	743	840	454	-24	61,0	0,17	230	<b>1095,32</b>
3.	<b>883602</b>	1775	743	840	555	-24	72,0	0,20	230	<b>1293,09</b>



### CHEST FREEZER WITH STAINLESS STEEL LID

No.	Code	W mm	D mm	H mm	V liters	T °C	M kg	P kW	U V	Price net (€)
1.	<b>883295</b>	1041	743	840	295	-24	44,5	0,15	230	<b>760,64</b>
2.	<b>883395</b>	1316	743	840	395	-24	50,5	0,15	230	<b>1064,89</b>
3.	<b>883459</b>	1492	743	840	454	-24	61,0	0,17	230	<b>1186,60</b>

**NEW**



### SET OF WHEELS FOR CHEST FREEZERS

Code	Price net (€)
<b>883001</b>	<b>17,71</b>

**NEW**



### PLASTIC BASKET FOR CHEST FREEZERS

Code	W mm	D mm	H mm	Price net (€)
<b>883002</b>	200	510	130	<b>11,41</b>





# STAINLESS STEEL FURNITURE

Stainless steel furniture is a solution for gastronomy, allowing for optimal use of space in every kitchen and providing storage room for equipment and other articles necessary in catering.

## SCREW-JOINED FURNITURE

Working tables .....	315
Tables with a basin .....	316
Hanging cabinets and shelves .....	316
Storage racks .....	317
Tables with a sink .....	317-318

## WELDED FURNITURE

Wall tables .....	319
Washbasin .....	319
Utility cabinets .....	320
Storage cabinets .....	320
Wall tables with a sink .....	321

# FURNITURE ACCORDING TO CUSTOM DESIGNS

As an expert in catering, we offer comprehensive aid in matching furniture specifically for your specific needs. Call us, and our consultant will help you create an offer that perfectly matches your requirements.



**construction consulting**



**technological solutions tailored to individual needs**

**SEE OUR LINE OF ERGONOMIC AND FUNCTIONAL EQUIPMENT TAILORED TO THE NEEDS OF ANY TYPE OF GASTRONOMY!**



Ergonomic and safe cooking line furniture fits any kitchen! Equipped with adjustable feet and a protective equipotential pin for ground connection the line matches all businesses.

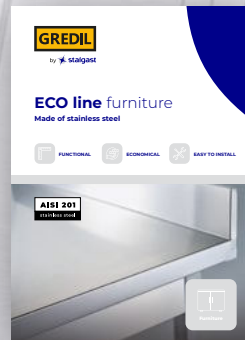

Discover the GREDIL ECO line products! Functional, economical, corrosion resistant and easy to assemble.

For full offer check Stalgast catalogs online

[stalgalast.eu/catalogs](https://stalgalast.eu/catalogs)



# Characteristics of our stainless steel furniture

All our products made of stainless steel are a monolithic welded or bolted structure according to the product's design requirements. All furniture is fitted with adjustable feet and a protective equipotential pin.



## TABLES, SINKS, WASHBASINS (WALL-MOUNTED)

- include 100x15 mm box-shaped upstand as standard



## TABLE TOPS

- made of stainless steel
- reinforced underneath with double-laminated panel
- the edge of the plate at the rear is protected by a stainless steel profile



## TABLE FEET

- made of square profiles
- adjustable feet in the range from +25 mm to -5 mm



## TABLE BASES

- reinforced in the upper part with a metal frame or square profile
- clearance between the floor and the lower edge of the profile, shelves, or bottom of the furniture



## DOORS

- made of two layers of sheet metal in the form of a stiffened can
- fitted with a magnetic latch
- fitted with a recessed handgrip (handle) made of ABS



## SLIDING DOORS

- suspended in the body on a stainless steel guide and moved by means of rollers
- easy disassembly of the door



## RACKS

- rack shelves reinforced by bending the inside edge and using metal profiles (omega type)
- maximum load on the shelves is 70 kg/m<sup>2</sup>
- adjustable feet in the range

- from +25 mm to -5 mm
- legs made of angle bar



## CABINETS

- cabinet bodies made of stainless steel
- cabinet legs made of square profiles
- cabinet shelves reinforced by bending the inside edge and using metal profiles (omega type)



## TABLE TOPS WITH SINKS

- lowered around the perimeter of the top edge
- reinforced with metal profiles („C“ shaped)
- equipped with a hole for a diameter tap min. 33 mm



## SINK COMPARTMENTS

- made of stainless steel
- equipped with a siphon hole



## BASINS

- made of stainless steel
- equipped with a hole for a diameter tap min. 33 mm

## SCREW-JOINED FURNITURE FOR SELF-ASSEMBLY

- high quality



INOX

PL STALGAST RÁDDOM

### WALLTABLE WITHOUT SHELF

- legs joined using screws
- tabletop reinforced with laminated board

Code	W mm	D mm	H mm	Price net (€)
<b>950026060</b>	600	600	850	<b>220,00</b>
<b>950026080</b>	800	600	850	<b>242,00</b>
<b>950026100</b>	1000	600	850	<b>264,00</b>
<b>950027120</b>	1200	700	850	<b>314,00</b>

NEW



### WALL TABLE WITH SHELF

- legs and shelf joined using screws
- tabletop reinforced with laminated board

Code	W mm	D mm	H mm	Price net (€)
<b>950046060</b>	600	600	850	<b>253,00</b>
<b>950046080</b>	800	600	850	<b>275,00</b>
<b>950046100</b>	1000	600	850	<b>297,00</b>
<b>950046120</b>	1200	600	850	<b>325,00</b>
<b>950046140</b>	1400	600	850	<b>349,00</b>
<b>950046180</b>	1800	600	850	<b>415,00</b>
<b>950047100</b>	1000	700	850	<b>307,00</b>
<b>950047120</b>	1200	700	850	<b>347,00</b>
<b>950047140</b>	1400	700	850	<b>382,00</b>
<b>950047150</b>	1500	700	850	<b>396,00</b>
<b>950047180</b>	1800	700	850	<b>443,00</b>

NEW



## TABLE WITH A SINGLE-CHAMBER BASIN

- chamber height **h = 300 mm**
- legs joined using screws
- ø 33 mm tap hole in the middle of the compartment
- offer dedicated to Stalgast taps p. 349-355

**NEW**

Code	W mm	D mm	H mm	W mm (chamber)	D mm (chamber)	H mm (chamber)	Price net (€)
<b>951336060</b>	600	600	850	486	470	300	<b>379,00</b>
<b>951336080</b>	800	600	850	686	470	300	<b>420,00</b>
<b>951336100</b>	1000	600	850	886	470	300	<b>504,00</b>
<b>951336120</b>	1200	600	850	1086	470	300	<b>539,00</b>
<b>951337060</b>	600	700	850	486	570	300	<b>399,00</b>
<b>951337080</b>	800	700	850	686	570	300	<b>440,00</b>
<b>951337120</b>	1200	700	850	1086	570	300	<b>595,00</b>



## TABLE WITH A SINGLE-CHAMBER BASIN

- chamber height **h = 400 mm**
- legs joined using screws
- ø 33 mm tap hole in the middle of the compartment
- offer dedicated to Stalgast taps p. 349-355

**NEW**

Code	W mm	D mm	H mm	W mm (chamber)	D mm (chamber)	H mm (chamber)	Price net (€)
<b>951346080</b>	800	600	850	686	470	400	<b>460,00</b>
<b>951346100</b>	1000	600	850	886	470	400	<b>525,00</b>
<b>951347080</b>	800	700	850	686	570	400	<b>490,00</b>
<b>951347100</b>	1000	700	850	886	570	400	<b>545,00</b>



## HANGING CABINET (SWINGING DOOR)

- movable shelf

**NEW**

Code	W mm	D mm	H mm	Price net (€)
<b>951704120</b>	1200	400	600	<b>375,00</b>



## HANGING CABINET (SLIDING DOOR)

- movable shelf

**NEW**

Code	W mm	D mm	H mm	Price net (€)
<b>951723100</b>	1000	300	600	<b>331,00</b>
<b>951723120</b>	1200	300	600	<b>356,00</b>
<b>951724100</b>	1000	400	600	<b>346,00</b>
<b>951724120</b>	1200	400	600	<b>375,00</b>



SINGLE ADJUSTABLE HANGING SHELF

NEW



Code	W mm	D mm	H mm	Price net (€)
<b>951753120</b>	1200	300	400	<b>99,00</b>

DOUBLE ADJUSTABLE HANGING SHELF

NEW



Code	W mm	D mm	H mm	Price net (€)
<b>951773120</b>	1200	300	660	<b>158,00</b>

STORAGE RACK SOLID SHELVES

- legs made of angle bar
- legs joined with shelves using screws
- maximum shelf load 70 kg/m<sup>2</sup>

NEW



Code	W mm	D mm	H mm	Price net (€)
<b>951884060</b>	600	400	1800	<b>287,00</b>
<b>951884080</b>	800	400	1800	<b>329,00</b>
<b>951884100</b>	1000	400	1800	<b>359,00</b>
<b>951885100</b>	1000	500	1800	<b>380,00</b>
<b>951885120</b>	1200	500	1800	<b>439,00</b>
<b>951886100</b>	1000	600	1800	<b>424,00</b>
<b>951886120</b>	1200	600	1800	<b>476,00</b>

TABLE WITH A SINGLE-CHAMBER SINK WITH A SHELF

- high hygienic standard
- pressed tabletop
- legs joined using screws
- ø 33 mm tap hole in the middle of the compartment
- the table has a 400x400x250 mm compartment
- offer dedicated to Stalgast taps p. 349-355

NEW



Code	W mm	D mm	H mm	Price net (€)
<b>954406060</b>	600	600	850	<b>395,00</b>



## TABLE WITH A SINGLE-CHAMBER SINK WITH A SHELF

- high hygienic standard
- pressed tabletop
- grooved drip surface
- legs and shelf joined using screws
- ø 33 mm tap hole in the middle of the compartment
- the table has a 400x400x250 mm compartment
- offer dedicated to Stalgast taps p. 349-355

**NEW**



Code	W mm	D mm	H mm	Price net (€)
<b>954456060</b>	600	600	850	<b>405,00</b>

## TABLE WITH A DOUBLE CHAMBER SINK WITH A SHELF

- high hygienic standard
- pressed tabletop
- grooved drip surface
- legs and shelf joined using screws
- ø 33 mm tap hole in the middle of the compartment
- the table has a 400x400x250 mm compartment
- offer dedicated to Stalgast taps p. 349-355

**NEW**



Code	Placement chamber/chambers	W mm	D mm	H mm	Price net (€)
<b>954466100</b>	P	1000	600	850	<b>468,00</b>
<b>954476100</b>	L	1000	600	850	<b>468,00</b>
<b>954476120</b>	L	1200	600	850	<b>495,00</b>

## TABLE WITH A DOUBLE CHAMBER SINK WITHOUT A SHELF

- high hygienic standard
- pressed tabletop
- legs and shelf joined using screws
- ø 33 mm tap hole between compartments
- the table has 400x400x250 mm compartments
- offer dedicated to Stalgast taps p. 349-355

**NEW**



Code	W mm	D mm	H mm	Price net (€)
<b>954536100</b>	1000	600	850	<b>548,00</b>

## TABLE WITH A DOUBLE CHAMBER SINK WITH A SHELF

- high hygienic standard
- pressed tabletop
- grooved drip surface - code 954596140
- legs and shelf joined using screws
- ø 33 mm tap hole between compartments
- the table has 400x400x250 mm compartments
- offer dedicated to Stalgast taps p. 349-355

**NEW**



Code	Placement chamber/chambers	W mm	D mm	H mm	Price net (€)
<b>954586100</b>	C	1000	600	850	<b>598,00</b>
<b>954586120</b>	C	1200	600	850	<b>635,00</b>
<b>954587100</b>	C	1000	700	850	<b>626,00</b>
<b>954596140</b>	P	1400	600	850	<b>672,00</b>



## WELDED FURNITURE

- high quality



### WALL TABLE WITH SLIDING DOORS

- movable shelf
- tabletop reinforced with laminated board

NEW



Code	W mm	D mm	H mm	Price net (€)
<b>950186100S</b>	1000	600	850	<b>596,00</b>
<b>950186120S</b>	1200	600	850	<b>672,00</b>
<b>950187100S</b>	1000	700	850	<b>649,00</b>
<b>950187120S</b>	1200	700	850	<b>712,00</b>

### WASHBASIN

- compartment built-up on three sides
- compartment size 300x240x100 mm
- ø 33 mm tap hole in the middle of the compartment
- offer dedicated to Stalgast taps p. 349-355

NEW



Code	W mm	D mm	H mm	Price net (€)
<b>9510254040S</b>	400	350	150	<b>180,00</b>

## UTILITY CABINET WITH WASHBASIN

- washbasin compartment built-in on three sides
- compartment size 330x300x150 mm
- vents
- adjustable shelf
- possibility of refitting doors in a single-door cabinet



Code	W mm	D mm	H mm	Price net (€)
<b>951465050S</b>	500	500	2000	<b>649,00</b>
<b>951475100S</b>	1000	500	2000	<b>989,00</b>

**NEW**

## STORAGE CABINET (SWINGING DOOR)

- three adjustable shelves

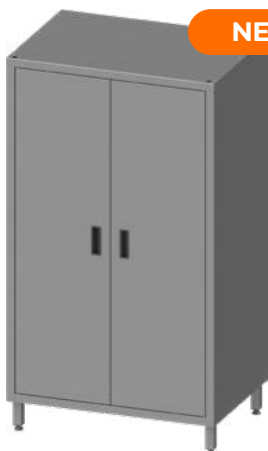

Code	W mm	D mm	H mm	Price net (€)
<b>951526100S</b>	1000	600	1800	<b>1131,00</b>

## PASS-THROUGH CABINET (SLIDING DOORS)

- two adjustable shelves



Code	W mm	D mm	H mm	Price net (€)
<b>951666080S</b>	800	600	1800	<b>1150,00</b>

**WALL TABLE WITH SWING DOORS**

- high hygienic standard
- pressed tabletop
- ø 33 mm tap hole between compartments
- the table has 400x400x250 mm compartments
- offer dedicated to Stalgast taps p. 349-355

**NEW**

Code	W mm	D mm	H mm	Price net (€)
<b>954616100S</b>	1000	600	850	<b>750,00</b>

**WALL TABLE WITH SLIDING DOORS**

- high hygienic standard
- pressed tabletop
- ø 33 mm tap hole between compartments
- the table has 400x400x250 mm compartments
- offer dedicated to Stalgast taps p. 349-355

**NEW**

Code	W mm	D mm	H mm	Price net (€)
<b>954646100S</b>	1000	600	850	<b>680,00</b>

**OVERFLOW PLUG WITH STRAINER**

- dedicated to washbasins and sinks
- stainless steel strainer prevents clogging the drain
- recommended for compartments with the following depths:

250 mm - code 651220

300 mm - code 651225

 proper operation requires purchasing  
the plug socket - code 651210

INOX

No.	Code	Product	Ø mm	H mm	Price net (€)
1.	<b>651225</b>	Plug	48	250	<b>20,50</b>
2.	<b>651220</b>	Plug	48	200	<b>19,10</b>
3.	<b>651210</b>	Plug socket	70	44	<b>15,00</b>



1



2



3



# HYGIENE

Equipment helpful in hygiene management, as well as in maintaining HACCP system standards and other quality management systems in restaurants, hotels, bars and mass catering establishments.

Workwear .....	323-325	Cleaning brushes.....	331
Safety cabinet .....	327	Ozone generator, disinfection unit - fogger .....	332
Waste container.....	327-329	Soap dispenser, hand towel dispenser.....	326
Universal egg/knife sterilizer, insecticide lamps .....	330-331		

## CHEF'S BLOUSE

- unisex
- fastened with stainless steel latches
- ingredients: 35% COT, 65% PES (200-210 g/m<sup>2</sup>)
- sizes in table 1



1



2

### 1 CHEF'S SWEATSHIRT

- short sleeve
- white

Code	Size	Price net (€)
<b>634075</b>	XL	<b>20,32</b>

### 2 CHEF'S SWEATSHIRT

- long sleeve
- white

Code	Size	Price net (€)
<b>634052</b>	S	<b>24,80</b>
<b>634053</b>	M	<b>24,80</b>
<b>634054</b>	L	<b>24,80</b>

## SIZE TABLES

- sizes in the tables are approximate

CHEF'S SWEATSHIRT (Table No.1)				
Size	Chest circumference	Back length	Sleeve length	
			(long sleeve)	(short sleeve)
S	102-106	72-73	49-50	22
M	107-120	74-75	50-51	23
L	121-128	76-78	51-52	24
XL	128-142	79-82	53-54	25
XXL	143-149	83-84	54-55	26
XXXL	150-156	85-86	55-56	26

**V-NECK SWEATSHIRT**

- unisex
- white
- short sleeve
- ingredients:  
35% COT, 65% PES (200-210 g/m<sup>2</sup>)
- sizes in table 1



Code	Size	Price net (€)
<b>634103</b>	M	<b>18,95</b>
<b>634104</b>	L	<b>18,95</b>
<b>634105</b>	XL	<b>18,95</b>

**CHEF'S HAT**

- made of 100% fleece
- price per item



Code	H mm	K pcs.	Price net (€)
<b>507221</b>	200	20	<b>0,65</b>
<b>507251</b>	250	20	<b>0,83</b>

**APRON**

- female
- white
- fastened with stainless steel latches
- ingredients:  
35% COT, 65% PES (200-210 g/m<sup>2</sup>)
- sizes in table 3



Code	Size	Price net (€)
<b>634083</b>	M	<b>28,12</b>
<b>634084</b>	L	<b>28,12</b>

**CAP**

- ingredients:  
65% polyester, 35% cotton
- keeps its shape long



Code	Price net (€)
<b>634003</b>	<b>7,20</b>

**SIZE TABLES**

- sizes in the tables are approximate

V-NECK SWEATSHIRT (Table No.1)		
Size	Chest circumference	Apron length
M	72-77	115-120
L	77-79	121-134
XL	79-81	135-147

APRON (Table No.2)			
Size	Chest circumference	Apron length	Sleeve length (long sleeve)
M	86-90	108-109	49-50
L	91-100	109-110	50-51

PANTS (Table No.3)		
Size	Circumference	Length
M	up to 102	113
L	up to 104	114
XL	up to 106	115

## PINAFORES

- white pinafore with white straps
- other pinafores have black straps



### MINI PINAFORE

- practical double pocket
- 40x120/175x210 mm

Code	Colour	L mm	Price net (€)
634011	●	373	9,95
634013	●	373	6,90

### MIDI PINAFORE

- practical double pocket
- 35x200/185x200 mm

Code	Colour	L mm	Price net (€)
634021	●	700	10,50
634022	○	700	6,83
634023	●	700	10,50



### MAXI PINAFORE

- no pockets

Code	Colour	L mm	Price net (€)
634031	●	1000	7,87
634033	●	1000	8,18



### APRON

- contains 35% cotton, 65% polyester

Code	Colour	L mm	Price net (€)
634043	●	960	12,20



**1 AUTOMATIC SOAP DISPENSER**

- contactless operation
- intended for gel soap
- simple and easy mounting on a wall or a stand item 643600
- made of durable plastic
- refillable tank
- non-spill valve
- fluid level control visor
- powered by 4 AA batteries (not included)



**2 AUTOMATIC DISINFECTING LIQUID DISPENSER**

- contactless operation
- designed for disinfecting liquids
- simple and easy mounting on a wall or a stand item 643600
- made of durable plastic
- refillable tank
- non-spill valve
- fluid level control visor
- powered by 4 AA batteries (not included)



**3 STAND FOR AUTOMATIC DISPENSERS**

- dedicated to dispensers 643520 and 642530
- made of powder coated steel
- dispenser cover made of stainless steel
- distance from the floor to the dispenser about 1020 mm
- drip tray included, distance from the dispenser about 157 mm



No.	Code	Product	Ø mm	W mm	D mm	H mm	V liters	Price net (€)
1.	<b>643520</b>	Soap dispenser	-	140	107	235	1,1	<b>43,27</b>
2.	<b>643530</b>	Liquid dispenser	-	140	107	235	1,1	<b>47,24</b>
3.	<b>643600</b>	Stand for dispensers	170	-	-	1320	-	<b>37,93</b>

**HAND TOWEL DISPENSER**

- stainless steel
- dedicated for universal hand towels ZZ
- with max. size 270x100mm
- wall mounted
- visible quantity control
- lock with key

INOX



Code	W mm	D mm	H mm	Price net (€)
<b>643000</b>	275	105	365	<b>59,60</b>

**SOAP DISPENSER**

- stainless steel
- made for liquid soaps
- wall mounted
- visible usage level of soap
- reusable
- non spill valve

INOX



Code	W mm	D mm	H mm	V liters	Price net (€)
<b>643500</b>	100	65	155	0,5	<b>28,30</b>

**PROTECTIVE GLOVES**

- perfect for general protection
- excellent adhesion on dry and wet surfaces
- contoured shape ensures high comfort of use
- the inner side of the gloves is covered with flocced cotton which provides extra comfort of use
- length approx. 320 mm, material thickness approx. 0,7 mm



Code	Size	Price net (€)
<b>505051</b>	S	<b>3,99</b>
<b>505052</b>	M	<b>3,99</b>

Code	Size	Price net (€)
<b>505053</b>	L	<b>3,99</b>
<b>505054</b>	XL	<b>3,99</b>



### SAFETY CABINET

- dedicated for social rooms in workplaces, schools to keep work and personal clothes
- powder coated steel
- vents for proper air circulation
- door lock
- easy to maintain clean
- visible card holder on door
- practical shelf and split chamber inside

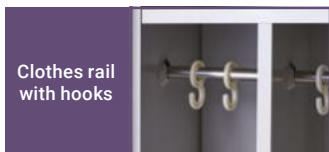

Clothes rail with hooks



Code	Description	W mm	D mm	H mm	Price net (€)
<b>662001</b>	1 door	400	450	1700	<b>128,00</b>
<b>662006</b>	2 doors	800	450	1700	<b>240,00</b>

### WASTE BAG STAND

- foot clamp button
- 2 wheels with brakes for easy movement of the stand
- intended for bags up to 120 l
- for indoor use

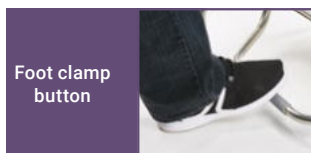

Foot clamp button

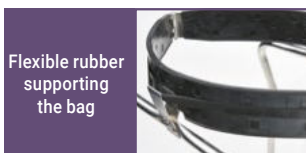

Flexible rubber supporting the bag



Code	W mm	D mm	H mm	Price net (€)
<b>068000</b>	430	530	960	<b>135,00</b>

TRASH CAN

- pedal mechanism allows contactless opening of the basket
- inner lining made of plastic, with holder

INOX



Lp.	Code	Description	Ø mm	H mm	V liters	Price net (€)
1.	<b>068201</b>	satin	300	440	20	<b>48,70</b>
2.	<b>068202</b>	gloss	300	440	20	<b>43,50</b>

TABLE BIN

- swing cover

INOX



Code	Ø mm	H mm	V liters	Price net (€)
<b>068203</b>	120	160	1,5	<b>13,20</b>

ASHTRAY WITH BIN FOR RUBBISH

- cigarette butt container
- non-slip rubber base improves stability of the basket and protects the floor against scratches
- powder coated

INOX



Code	Description	Ø mm	H mm	V liters	Price net (€)
<b>068213</b>	black	200	700	15	<b>52,20</b>

WASTE CONTAINER

- made of high quality plastic
- slim design allows fitting the container in small spaces
- has comfortable grips for handling
- grip for easy emptying



Cover handle



Ergonomic handle

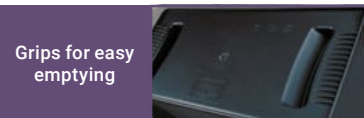

Grips for easy emptying



No.	Code	Product	W mm	D mm	H mm	V liters	Price net (€)
1.	<b>067060</b>	Waste container	507	272	632	60	<b>80,10</b>
2.	<b>067061</b>	Trash cover 067060	523	288	70	-	<b>65,50</b>

PP



1 LID

Code	Product	Ø (inner) mm	Ø (outer) mm	H mm	Price net (€)
<b>068081</b>	Lid for 068080	506	550	36	<b>14,00</b>
<b>068121</b>	Lid for 068120	575	620	36	<b>16,50</b>

2 WASTE CONTAINER

Code	Product	Ø (inner) mm	Ø (outer) mm	H mm	V liters	Price net (€)
<b>068080</b>	Waste container	455	490	610	80	<b>50,60</b>
<b>068120</b>	Waste container	510	550	690	120	<b>61,60</b>

3 WHEELED BASE

• wheelbase load capacity: 068084 - 100 kg, 068124 - 200 kg

Code	Product	Ø mm	H mm	Price net (€)
<b>068084</b>	Wheeled base for 068080	403	72	<b>33,70</b>
<b>068124</b>	Wheeled base for 068120	455	130	<b>42,70</b>

1 COVER

Code	Product	Colour	Ø (inner) mm	Ø (outer) mm	H mm	Price net (€)
<b>068048</b>	Cover	●	398	447	52	<b>12,90</b>
<b>068764</b>	Cover	●	500	548	66	<b>16,40</b>
<b>068138</b>	Cover	●	565	614	59	<b>18,80</b>

2 WASTE CONTAINER

Code	Product	Colour	Ø (inner) mm	Ø (outer) mm	H mm	V liters	Price net (€)
<b>068044</b>	Container	●	363	468	440	38	<b>41,00</b>
<b>068754</b>	Container	●	455	558	590	75	<b>62,40</b>
<b>068128</b>	Container	●	520	630	700	120	<b>75,20</b>

3 WHEELED BASE

- fits waste containers with a capacity of 75 and 120 liters
- system fixing the container to the base

Code	Ø mm	H mm	Price net (€)
<b>068144</b>	464	168	<b>68,10</b>



**INSECTICIDE LAMP**

- UV lamp to combat flying insects
- quiet work, no odor
- for indoor use only
- wall-mounted, suspension or standing
- energy-efficient, high-performance device
- easy-to-clean housing with removable bottom tray
- trap with a high voltage grid
- has a chain handle
- working range:  
692211 - 20 m  
692216 - 30 m  
692221 - 50 m



Code	W mm	D mm	H mm	P1* W	U V	Price net (€)
692211	390	100	320	2x10	230	51,00
692216	500	95	320	2x15	230	65,30
692221	650	95	320	2x20	230	69,00

Code	Product	P1* W	Price net (€)
692010	Lamp for 692211	10	3,72
692015	Lamp for 692216	15	4,16
692020	Lamp for 692221	18	4,63

**INSECTICIDE LAMP**

- large, easy-to-clean tray
- strong and robust housing made of fireproof plastic
- can be hanged
- lifetime of LED lamps ~20,000 h
- working range:  
692116 up to 80 m<sup>2</sup>  
692216 up to 100 m<sup>2</sup>  
692213 up to 150 m<sup>2</sup>



Code	W mm	D mm	H mm	P1* W	U V	Price net (€)
692116	437	100	265	2X4	230	48,00
692212	542	100	265	2X6	230	55,00
692213	696	100	265	2X8	230	64,00

Code	Product	U W	Price net (€)
692016	LED lamp for 692116	4	9,67
692013	LED lamp for 692213	8	11,80

**INSECTICIDAL LAMP, LED**

- a spatter-free UV lamp with glue is designed to work against flying insects
- quiet operation, no smelling
- for indoor use only
- strong and durable housing made of fireproof plastic
- energy-saving and efficient device
- large, easy-to-clean tray
- operating range up to ~ 100 m<sup>2</sup>
- lifetime of LED lamps ~ 20,000 hours



Code	Product	W mm	D mm	H mm	L mm	P1* W	U V	Price net (€)
692315	Insecticidal lamp	532	140	320	-	2x6	230	90,00
692003	Glue for insecticide lamp 692315	-	-	-	-	-	-	4,90

### INSECTICIDAL LAMP WITH A FAN

- power cord length ~ 1 m
- waterproof grade: IPX4
- strong and durable housing made of fireproof plastic
- hanging option (wall, ceiling)
- powerful and quiet fan with a container for insects
- range of operation up to: ~ 750 m<sup>2</sup>
- UV lamp life: ~ 8,000 hours



Code	Product	Ø mm	H mm	M kg	P W	U V	Price net (€)
<b>692265</b>	Insecticidal lamp	320	580	3,8	40	230	<b>190,00</b>
<b>692266</b>	UV tube for lamp 692265	-	-	-	-	-	<b>14,00</b>

### UNIVERSAL STERILIZER

- device with UV lamps for surface disinfection of eggs, knives and utensils
- 30 eggs or 17 knives 320 mm long and 40 mm high can be disinfected at one time
- irradiation (sterilization) time: 150 seconds
- automatic lamp switches-off when the drawer is open
- chrome steel grille
- one irradiation cycle kills up to 100% of bacteria: salmonella, E. Coli, cocci, aerobes, coliform bacteria and fungi

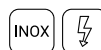

Code	W mm	D mm	H mm	M kg	P W	U V	Price net (€)
<b>690552</b>	425	430	280	11	77	230	<b>415,00</b>

#### 1 TABLETOP BRUSH

- comfortable plastic grip makes cleaning easier
- durable and strong bristles
- can be hanged on a hanger

Code	Colour	W mm	D mm	H mm	Price net (€)
<b>667053</b>	●	285	45	75	<b>7,46</b>



#### 2 MULTIFUNCTION BRUSH

- comfortable plastic grip makes cleaning easier
- durable and strong bristles
- can be hanged on a hanger

Code	Colour	W mm	D mm	H mm	Price net (€)
<b>667143</b>	●	240	75	75	<b>9,02</b>





**DISINFESTION UNIT - FOGGER**

- device for disinfestation of rooms, facilities and devices by means of fogging
- application: disinfestation, elimination of mosquito, flies, fumigation, odor removal, dust removal, temperature control and temperature reduction
- performance: up to 260 ml/min
- spraying range: up to 10 m
- working temperature 0-40°C
- fluid tank capacity: 4,5 l
- power cord length: 5 m
- weight: 4 kg

Code	W mm	D mm	H mm	V liters	M kg	P kW	U V	Price net (€)
<b>649450</b>	460	260	430	4,5	3,5	1,2	230	<b>171,05</b>



**OZONE GENERATOR**

- application: ozonation of rooms, vehicles - air purification of pollutants, viruses, fungi, tobacco smoke and other odors
- efficiency: 5000 mg/h (30-70 m³ / 45-90 min)
- one-time disinfection range up to 50 m³
- airflow 80-100 m³/h
- maximum working time: 120 min
- power/voltage: 0,065 kW/230 V

Code	W mm	D mm	H mm	P kW	U V	Price net (€)
<b>690620</b>	180	280	180	0,065	230	<b>383,05</b>



**OZONE GENERATOR**

- application: ozonation of rooms, vehicles - air purification of pollutants, viruses, fungi, tobacco smoke and other odors
- efficiency: 10000 mg/h (30-150 m³ / 30-90 min)
- one-time disinfection range up to 100 m³
- airflow 80-100 m³/h
- maximum working time: 120 min
- power/voltage: 0,095 kW/230 V

Code	W mm	D mm	H mm	P kW	U V	Price net (€)
<b>690640</b>	180	280	180	0,095	230	<b>460,00</b>



**OZONE GENERATOR**

- application: ozonation of rooms, vehicles - air purification of pollutants, viruses, fungi, tobacco smoke and other odors
- efficiency: 10000 mg/h (30-150 m³ / 30-90 min)
- housing material: stainless steel
- one-time disinfection range up to 100 m³
- airflow 80-100 m³/h
- maximum working time: 120 min
- power/voltage: 0,10 kW/ 230 V

Code	W mm	D mm	H mm	P kW	U V	Price net (€)
<b>691640</b>	180	320	170	0,1	230	<b>610,56</b>





# DISHWASHING

Professional dishwashers guaranteeing the highest performance and speed of washing and scalding.

Dishwashers.....	334-340	Water column for line 700.....	351
Racks for dishwashers.....	342-343	Fillers and taps .....	349-355
Water softeners .....	344-346	Organic waste shredders.....	347
Touchless washbasins.....	378	Drip trays for plates.....	341

**STALGAST DISHWASHERS**

**AQUA**

**NEW**



Made in Poland:  
**Modern catering equipment  
factory in Radom.**

In 2008, we launched a factory in Radom manufacturing stainless steel catering furniture, dishwashers, heating lines, serving lines and plastic catering accessories.

**HOOD-TYPE DISHWASHER**

- professional dishwasher with sanitization function
- electronic control
- suitable for washing trays, glassware, cutlery and plates
- detergent and rinse aid dispenser
- cycle time 120/180 sec.
- digital temperature display for the boiler and compartment
- 2 pairs of washing-rinsing arms (top/bottom)
- water consumption 2.5 liters/cycle
- maximum height of the washed dishes 415 mm (+/- 5mm)
- rack 500x500 mm
- racks included: a rack for plates, a glassware rack, and a cutlery rack and container
- the appliance should have a water purifier installed to protect it from scaling
- adjustable feet (45 mm)



**AQUA**

**NEW**



Top washing-rinsing arms



Bottom washing-rinsing arms



Surface filter



Hood lifting handle



Control panel



Code	Product	W mm	D mm	H mm	P kW	U V	Price net (€)
803021	Hood-type dishwasher with built-in detergent dispenser	728	816	1505	10,8	400	3036,44

Top washing-rinsing arms



Pressed washing chamber



Ergonomic design of guides



Bottom washing-rinsing arms



Hood lifting handle



**HOOD-TYPE DISHWASHER**



- professional dishwasher with sanitization function
- electronic control
- suitable for washing trays, glassware, cutlery and plates
- detergent and rinse aid dispenser
- cycle time 90/120/180 sec.
- digital temperature display for the boiler and compartment
- 2 pairs of washing-rinsing arms (top/bottom)
- water consumption 2.5 liters/cycle
- maximum height of the washed dishes 415 mm (+/- 5mm)
- rack 500x500 mm
- includes 3 racks: a rack for plates, a universal rack, and a rack for glassware, as well as a cutlery container
- the appliance should have a water purifier installed to protect it from scaling
- adjustable feet (45 mm)

**AQUA**

**NEW**



Code	Product	W mm	D mm	H mm	P kW	U V	Price net (€)
<b>803035</b>	Hood-type dishwasher with built-in detergent dispenser	728	816	1505	10,8	400	<b>3414,45</b>
<b>803036</b>	Hood-type dishwasher with built-in detergent dispenser and a rinse boosting pump	728	816	1505	10,8	400	<b>4181,80</b>
<b>803037</b>	Hood-type dishwasher with built-in detergent dispenser, rinse boosting pump and a drain pump	728	816	1505	10,8	400	<b>4421,79</b>

# STALGAST DISHWASHERS AQUA SERIES

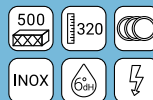
**NEW**

## AQUA

### UNIVERSAL DISHWASHER POWER DIGITAL

- professional dishwasher with sanitization function
- electronic control
- surface filter as standard
- dishwasher adapted to wash GN 1/1 trays
- detergent and rinse aid dispenser
- cycle time 90/120/180 sec.
- boiler and chamber operating temperature displays
- 2 pairs of washing-rinsing arms (top/bottom)
- water consumption 2.5 liters/cycle
- maximum height of the washed dishes 320 mm
- rack 500x500 mm
- includes 3 racks: for plates, universal, for glassware and cutlery container
- the appliance should have a water purifier installed to protect it from scaling

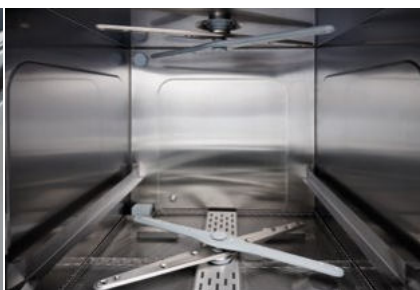

Code	Product	W mm	D mm	H mm	P kW	U V	Price net (€)
<b>801555</b>	Universal dishwasher 500x500 with detergent dispenser	565	685	835	6,4	400	<b>2080,60</b>
<b>801556</b>	Universal dishwasher 500x500 with detergent dispenser and a drain pump	565	685	835	6,4	400	<b>2184,63</b>
<b>801565</b>	Universal dishwasher 500x500 with detergent dispenser and a rinse boosting pump	565	685	835	6,4	400	<b>2288,66</b>
<b>801566</b>	Universal dishwasher 500x500 with detergent dispenser, a drain pump and a rinse boosting pump	565	685	835	6,4	400	<b>2502,90</b>
<b>802010</b>	Base for universal dishwasher	575	560	450	-	-	<b>200,00</b>



Top washing-rinsing arms



Heater



Control panel



Bottom washing-rinsing arms



**UNIVERSAL DISHWASHER**



- professional dishwasher with sanitization function
- electromechanical control
- dishwasher adapted to wash GN 1/1 trays
- rinse-aid dispenser (in selected versions)
- cycle time 120/180 sec.
- boiler and chamber operating temperature displays
- 2 pairs of washing-rinsing arms (top/bottom)
- water consumption 2.5 liters/cycle
- maximum height of the washed dishes 320 mm
- rack size: 500x500 mm
- includes 3 racks: for plates, universal, for glassware and cutlery container
- sound signal at the end of the washing cycle
- allows using a surface filter
- the appliance should have a water purifier installed to protect it from scaling

**AQUA**

**NEW**



Code	Product	W mm	D mm	H mm	P kW	U V	Price net (€)
<b>801505</b>	Universal dishwasher	565	685	835	4,9 / 3,4	400 / 230	<b>1705,68</b>
<b>801506</b>	Universal dishwasher with detergent dispenser	565	685	835	4,9 / 3,4	400 / 230	<b>1835,46</b>
<b>801507</b>	Universal dishwasher with detergent dispenser and drain pump	565	685	835	4,9 / 3,4	400 / 230	<b>1951,85</b>
<b>801516</b>	Universal dishwasher with detergent dispenser and rinse boosting pump	565	685	835	4,9 / 3,4	400 / 230	<b>2060,00</b>
<b>801517</b>	Universal dishwasher with detergent dispenser, drain pump and rinse boosting pump	565	685	835	4,9 / 3,4	400 / 230	<b>2184,63</b>
<b>801021</b>	Detergent dispenser	67	70	100	-	230	<b>107,80</b>
<b>802010</b>	Base for universal dishwasher	575	560	450	-	-	<b>200,00</b>

GLASSWARE WASHER

- professional dishwasher with sanitization function
- electromechanical control system
- suitable for washing glassware, cutlery and small plates
- height adjusted for glass and porcelain cleaning in models 801350, 801351 - 250 mm, in models 801400, 801401 - 300 mm
- cycle time 120/180 sec.
- boiler and chamber operating temperature displays
- 3 arms (washing and rinsing arms at the bottom, rinsing arm at the top)
- water consumption 2.4 liters/cycle
- rack sizes:  
801350, 801351 - 350x350 mm,  
801400, 801401 - 400x400 mm
- includes a universal glassware rack and cutlery container
- the appliance should have a water purifier installed to protect it from scaling



**AQUA**

**NEW**



Top washing-rinsing arms



Temperature indicators



Control panel



Bottom washing-rinsing arms



Code	Product	W mm	D mm	H mm	P kW	U V	Price net (€)
<b>801350</b>	Glassware dishwasher with detergent dispenser	415	530	680	2,77	230	<b>1196,86</b>
<b>801351</b>	Glassware dishwasher with detergent dispenser and a drain pump	415	530	680	2,77	230	<b>1279,26</b>
<b>801352</b>	Glassware dishwasher without dispensers	415	530	665	2,77	230	<b>1134,03</b>
<b>801400</b>	Glassware dishwasher with detergent dispenser	465	565	720	2,77	230	<b>1289,56</b>
<b>801401</b>	Glassware dishwasher with detergent dispenser and a drain pump	465	565	720	2,77	230	<b>1397,71</b>
<b>801402</b>	Glassware dishwasher without dispensers	465	565	700	2,77	230	<b>1238,06</b>
<b>804012</b>	Dishwasher base 400x400	475	460	630	-	-	<b>200,00</b>



**DISHWASHER SET WITH BASE**

- dishwasher set with stand, with or without a detergent dispenser
- electromechanical control
- dishwasher adapted to wash GN 1/1 trays
- rinse-aid dispenser (in selected versions)
- cycle time 120/180 sec.
- boiler and chamber operating temperature displays
- 2 pairs of washing-rinsing arms (top/bottom)
- water consumption 2.5 liters/cycle
- rack size: 500x500 mm
- includes 3 racks: for plates, universal, for glassware and cutlery container
- sound signal at the end of the washing cycle
- allows using a surface filter
- the appliance should have a water purifier installed to protect it from scaling
- base made of stainless steel, two levels of guide rails for 500x500 mm baskets
- base dimensions 575x560x450 mm (WxDxH)



**AQUA**



Code	Product	W mm	D mm	H mm	P kW	U V	Price net (€)
801501	Universal dishwasher with base	565	685	1285	4.9/3.4	400/230	2024,00
801502	Universal dishwasher with built-in detergent dispenser and base	565	685	1285	4.9/3.4	400/230	2112,00

CUTLERY CUP



Code	Ø mm	H mm	Price net (€)
<b>815020</b>	115	145	<b>8,48</b>

CUTLERY CUP



Code	Ø mm	H mm	Price net (€)
<b>815010</b>	115	145	<b>2,58</b>

CUTLERY CONTAINER



Code	Ø mm	H mm	Price net (€)
<b>815025</b>	120	140	<b>9,02</b>

CUTLERY CUP CONTAINER

• container without cups



No.	Code	W mm	D mm	H mm	Price net (€)
1.	<b>815300</b>	385	150	180	<b>56,90</b>
2.	<b>815400</b>	265	305	200	<b>62,00</b>

CUTLERY CONTAINER

• container external size equal to GN 1/1



Code	W mm	D mm	H mm	Price net (€)
<b>063110</b>	530	325	100	<b>11,90</b>

PLATE DRIP TRAY

• possibility of storing up to 40 plates with Ø160 mm



Code	W mm	D mm	H mm	Price net (€)
<b>010100</b>	1000	255	500	<b>145,00</b>

CUTLERY RACK



PL STALGAST  
RADOM

Code	W mm	D mm	H mm	Price net (€)
<b>810100</b>	500	500	100	<b>17,70</b>

PLATE RACK



PL STALGAST  
RADOM

Code	W mm	D mm	H mm	Price net (€)
<b>810300</b>	500	500	100	<b>17,70</b>

GLASSWARE RACK



PL STALGAST  
RADOM

Code	W mm	D mm	H mm	Price net (€)
<b>810501</b>	500	500	100	<b>17,70</b>

TRAY BASKET GN 1/1



PL STALGAST  
RADOM

Code	W mm	D mm	H mm	Price net (€)
<b>810210</b>	500	500	100	<b>17,70</b>

UNIVERSAL BASKET

- fits into the glassware
- washer



Code	W mm	D mm	Price net (€)
<b>810400</b>	400	400	<b>33,66</b>

PLATE RACK

- for washing plates, glassware and trays
- fits into the glassware washer



Code	W mm	D mm	H mm	Price net (€)
<b>810150</b>	400	400	110	<b>27,50</b>

CUTLERY RACK



Code	W mm	D mm	H mm	Price net (€)
<b>815100</b>	430	210	150	<b>11,80</b>

RACK TROLLEY

- for transporting baskets
- steel pipe handle
- all wheel are swivelling



Code	W mm	D mm	H mm	Price net (€)
<b>810000</b>	540	540	960	<b>164,00</b>

## GLASSWARE RACK



9pcs



16pcs



25pcs



36pcs



49pcs



## BASKET ADAPTER



9pcs



16pcs



25pcs



36pcs



49pcs



Code	Description	W mm	D mm	H mm	Price net (€)
<b>810900</b>	9 pieces	500	500	104	<b>16,00</b>
<b>811600</b>	16 pieces	500	500	104	<b>19,80</b>
<b>812500</b>	25 pieces	500	500	104	<b>19,80</b>
<b>813600</b>	36 pieces	500	500	104	<b>19,80</b>
<b>814900</b>	49 pieces	500	500	104	<b>19,80</b>

Code	Description	W mm	D mm	H mm	Price net (€)
<b>810910</b>	9 pieces	500	500	45	<b>11,00</b>
<b>811610</b>	16 pieces	500	500	45	<b>11,00</b>
<b>812510</b>	25 pieces	500	500	45	<b>11,00</b>
<b>813610</b>	36 pieces	500	500	45	<b>9,90</b>
<b>814910</b>	49 pieces	500	500	45	<b>9,90</b>

## WATER FILTER

- reduce the carbonate hardness of drinking water
- they prevent limescale in connected terminal appliances
- they rackd heavy metal ions, e.g. lead and copper
- reduce water cloudiness
- reduce organic contaminants affecting the water's taste
- they remove chlorine residues in filtered and tap water

### WATER FILTER

- universal water filter
- electronic measurement and display module: automatic indication of the remaining filter capacity, information on exceeding the filter's capacity

Electronic measurement and display module



Code	Product	Ø mm	H mm	S liters	Price net (€)
<b>823402</b>	Purity 450	249	408	4217	<b>829,00</b>
<b>823401</b>	Removable cartridge for 823402	-	-	4217	<b>140,00</b>



### WATER FILTER

- prevents deposits and dirt in convection steam ovens

Code	Product	Ø mm	H mm	S liters	Price net (€)
<b>823045</b>	Purity 450 Steam	249	408	3680	<b>699,00</b>
<b>823046</b>	Removable cartridge for 823045	-	-	3680	<b>166,00</b>

### WATER FILTER

- prevents the formation of deposits in dishwashers
- ensures optimal quality of washing glassware, cutlery and dishes

Code	Product	W mm	D mm	H mm	S liters	Price net (€)
<b>824130</b>	Purity 1200 Clean	288	255	550	12000	<b>1188,00</b>
<b>824131</b>	Removable cartridge for 824130	-	-	-	12000	<b>252,00</b>



# WATER FILTER



- prevents limescale in connected appliances
- it racks heavy metal ions, e.g. lead and copper
- reduce organic contaminants affecting the water's taste
- guarantees longer service life of connected appliances



The filter consists of a head and a replaceable cartridge mounted to the head



## 1 HEAD

- heads with factory-preset bypass 0% or 30%
- JG8 or 3/8" connection
- 30% bypass heads intended for supplying boiler appliances

## 2 HEAD CARTRIDGE

Code	W mm	D mm	H mm	S liters	Price net (€)
<b>822825</b>	149	149	554	5889	<b>256,00</b>
<b>822827</b>	124	123	476	3464	<b>164,00</b>
<b>822829</b>	117	108	421	2086	<b>112,00</b>
<b>822831</b>	117	108	265	831	<b>71,00</b>

## 3 WATER METER

- 3/8" thread
- flow range 10-100 liters/h

Code	Price net (€)
<b>823998</b>	<b>132,00</b>

Code	Product	Description	Price net (€)
<b>822801</b>	Purity C head by-pass 30%	3/8" connection	<b>53,60</b>
<b>822800</b>	Purity C head by-pass 0%	JG8 connection	<b>53,60</b>

## HEAD

- fits filters 822060, 822080 and 822850
- connection 3/8"

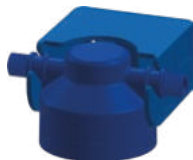

Code	Price net (€)
<b>822185</b>	<b>47,00</b>

## CARTRIDGE

- quick and easy replacement
- chlorine reduction ~ 85%
- improves the taste and smell of water
- water pH stabilization
- 822060 designed for devices serving drinking water, perfect for making espresso froth
- 822080 designed for ice cube makers, coffee machines and vending machines
- 822850 designed for convection ovens, coffee machines, vending machines



## WATER FLOW COUNTER

- 3/8 nut
- max. programmable amount of L 99500
- the meter shows the current flow and the remaining amount of water before replacement of the cartridge
- fits filters 822060, 822080 and 822850
- water flow 1.5 - 14 l / min
- sound signaling informing about the need to replace the cartridge
- powered by AAA batteries supplied in the set



Code	Price net (€)
<b>823850</b>	<b>77,00</b>

Code	Product	S liters	Price net (€)
<b>822060</b>	Cartridge - ONE MG+	6000	<b>116,89</b>
<b>822080</b>	Cartridge - ONE UF	8000	<b>137,58</b>

## COARSE WATER FILTER

- the coarse nanotube filter is intended for installation on water connection lines
- extends the life of the resin in all water softeners and water conditioners
- protects appliances against contamination
- 100 µm filtration
- transparent lampshade allows viewing the degree of contamination in the cartridge
- 3/4" connection

No.	Code	Product	Ø mm	H mm	K pcs	M kg	Price net (€)
1.	<b>820011</b>	Coarse water filter	84	180	-	1,5	<b>23,30</b>
2.	<b>820010</b>	Removable cartridge	-	-	1	-	<b>5,55</b>



## WATER SOFTENER

- intended for dishwashers, convection steam ovens, coffee makers and ice makers
- maximum water flow ~ 8.33 l/min
- automatic regeneration depends on water consumption
- the regeneration process does not block the operation of powered appliances
- maximum water temperature up to 45°C
- salt container approx. 10 kg
- the cartridge should be regenerated with salt tablets (Code 820999)
- automatic



Code	W mm	D mm	H mm	U V	Price net (€)
<b>822998</b>	200	360	510	230	<b>618,00</b>

## WATER SOFTENER

- intended for dishwashers, convection steam ovens, coffee makers and ice makers
- semi-automatic control system
- regeneration process initiated by pressing the regeneration button
- the cartridge should be regenerated with salt (Code 820999)



Code	W mm	D mm	H mm	U V	Price net (€)
<b>822990</b>	180	420	500	230	<b>420,00</b>

## WATER SOFTENER

- appliance reducing water hardness
- reduces limescale deposits in appliances and extends the operation of heaters
- maximum temperature of flowing water 45°C
- the cartridge should be regenerated with salt (Code 820999)
- recommended water meter (Code 823998)

Code	Ø mm	H mm	V liters	Price net (€)
<b>820081</b>	185	410	8	<b>120,00</b>
<b>820121</b>	185	510	12	<b>150,70</b>
<b>820161</b>	185	610	16	<b>173,00</b>







## ORGANIC WASTE SHREDDERS

- the shredder breaks down waste in a stream of cold water into microparticles, and drains them in liquid form into the sewage system.
- allows shredding:
  - vegetable and fruit peelings
  - small chicken bones
  - egg shells
  - coffee grounds without filters
  - melon shell
  - cooked meat

### ORGANIC WASTE SHREDDER

- shredder compartment made of stainless steel
- overload protection
- pneumatic switch included

INOX

### ORGANIC WASTE SHREDDER

- flange made of aluminum alloy
- overload protection
- pneumatic switch included



Code	Ø mm	H mm	N rpm	P kW	U V	Price net (€)
<b>650025</b>	170	330	4000	0,56	230	<b>190,00</b>

### PNEUMATIC SWITCH

- for assembly with 650001 shredder

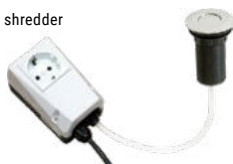

Code	Price net (€)
<b>650090</b>	<b>73,30</b>



Shredder  
mechanism made  
of stainless steel



Code	Ø mm	H mm	N rpm	P kW	U V	Price net (€)
<b>650022</b>	174	387	4200	0,56	230	<b>238,00</b>

**OVERFLOW PLUG WITH A SCREEN**

- dedicated to washbasins and sinks
- stainless steel strainer prevents clogging the drain
- recommended for compartments with the following depths:  
250 mm (code 651220)  
300 mm (code 651225)
- proper operation requires purchasing the plug socket (Code 651210)



INOX

No.	Code	Product	Ø mm	H mm	Price net (€)
1.	<b>651225</b>	Plug	48	250	<b>20,50</b>
2.	<b>651220</b>	Plug	48	200	<b>19,10</b>
3.	<b>651210</b>	Plug socket	70	44	<b>15,00</b>

**CONTACTLESS WASHBASIN WITH A KNEE SWITCH AND A TAP**

- easy, hygienic knee operation by pressing the front panel
- rim spout included
- made of stainless steel
- dimensions of the chamber:  
~ diameter 350 mm and depth 120 mm

INOX



Code	W mm	D mm	H mm	Price net (€)
<b>610004</b>	400	400	225	<b>286,00</b>

**CONTACTLESS WASHBASIN WITH KNEE SWITCH, TAP AND A SOAP DISPENSER**

- easy, hygienic knee operation by pressing the front panel
- the set includes a tap, soap dispenser, hydraulic jack, assembly elements and 1/2 inch ~50 cm hoses
- made of stainless steel
- chamber dimensions: ~400x335x205 mm

INOX



Code	W mm	D mm	H mm	Price net (€)
<b>610005</b>	400	330	570	<b>257,00</b>



**WASHBASIN TAP**

- single-hole washbasin tap
- sink-mounted tap, required hole in the sink Ø33-35 mm

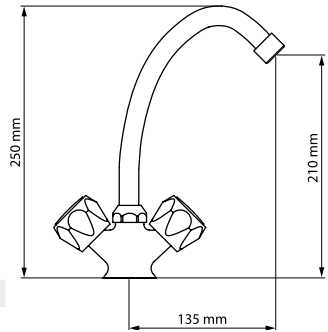

Code	Price net (€)
651100	81,20



**WASHBASIN TAP**

- single-hole elbow washbasin tap
- sink-mounted tap, required hole in the sink Ø33-35 mm

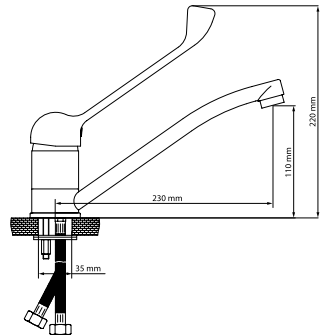

Code	Price net (€)
651110	107,00



Shower with 500 mm extension cord

**SHOWER FAUCET**

- single-hole elbow washbasin tap with pull-out shower
- variable waterjet
- sink-mounted tap, required hole in the sink Ø40mm

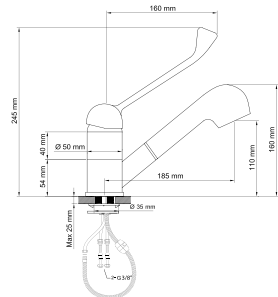

Code	Price net (€)
651111	168,00

**WASHBASIN TAP**

- single-hole washbasin tap
- required hole in the sink Ø33-35mm

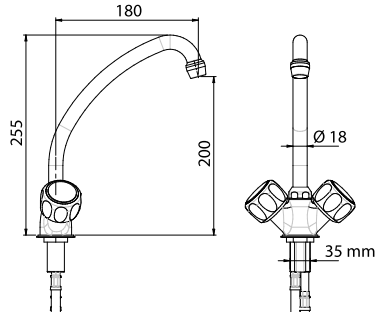

Code	Price net (€)
651102	91,40

**WASHBASIN TAP**

- single-hole elbow washbasin tap
- required hole in the sink Ø33-35mm

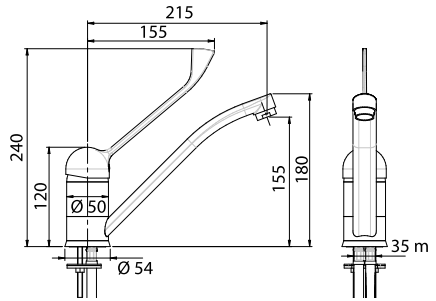

Code	Price net (€)
651112	110,00

**SHOWER FAUCET**

- single-hole elbow washbasin tap with pull-out shower
- variable waterjet
- required hole in the sink Ø33-35mm

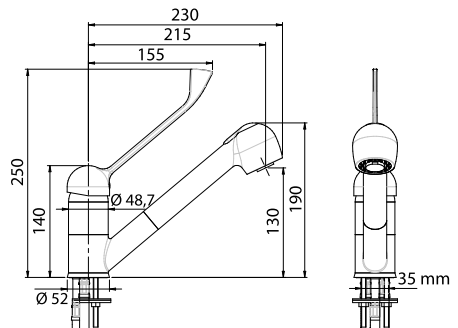

Code	Price net (€)
651113	184,00

## SHOWER FAUCET

- single-hole faucet recommended for "open" kitchens



Code	Price net (€)
651114	361,00

## FAUCET WITH EXTENDABLE SHOWER

- single-hole faucet recommended for "open" kitchens



Code	Price net (€)
651115	465,00

## WATER COLUMN FOR LINE 700

- dedicated for island assembly of 700 line appliances

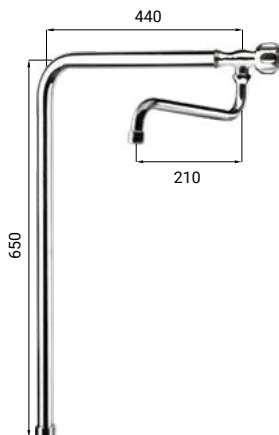

Code	H mm	Price net (€)
651601	675	231,00

## NON-CONTACT FAUCET WITH INFRARED SENSOR

- required hole in the sink  $\varnothing=33$  mm
- powered by electricity with a voltage of 100-240 V
- can be powered by batteries 4xAA 1.5 V in case of power failure
- operating pressure, min/max 0.5 ÷ 8 bar (recommended 3 bar)
- maximum sensor distance 10 cm  $\pm$  2 cm - water flow 6 l / min at a pressure of 3 bar



Code	Price net (€)
651116	598,00

VERTICAL TAP

- required hole in the sink Ø 27

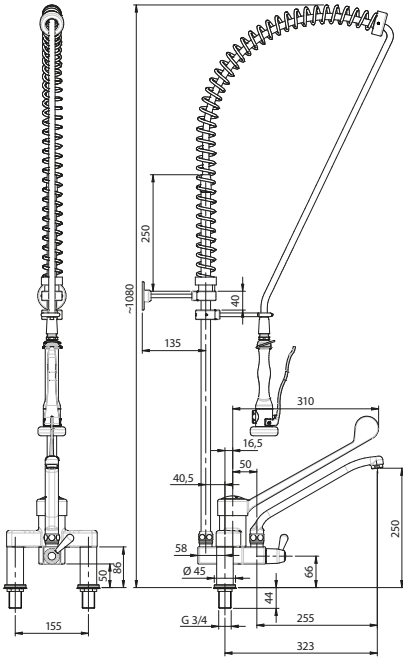

Code	Price net (€)
651527	629,00

# FILLERS

## FILLER

- standing faucet, 2-hole with spray washer and spout
- standing faucet fastened to wall, with wall bracket

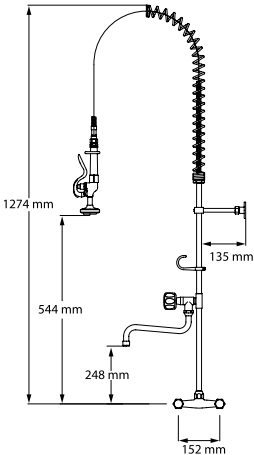

Code	Price net (€)
651542	390,00

## FILLER

- standing faucet, 1-hole with spray washer and spout
- standing faucet fastened to the sink table, with wall bracket, required hole in the sink Ø33-35mm

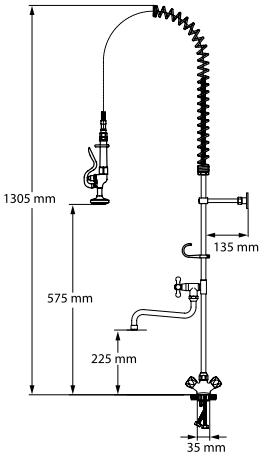

Code	Price net (€)
651522	373,00



FILLER

- standing faucet, 1-hole with spray washer
- required hole in the sink Ø33-35mm



Code	Price net (€)
651513	316,00

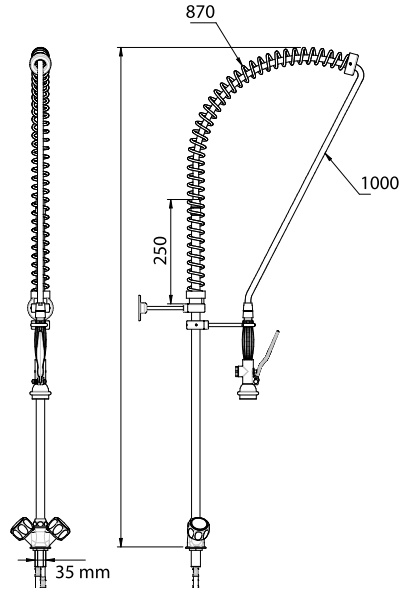

FILLER

- standing faucet, 1-hole with spray washer and spout
- required hole in the sink Ø33-35mm



Code	Price net (€)
651524	377,00

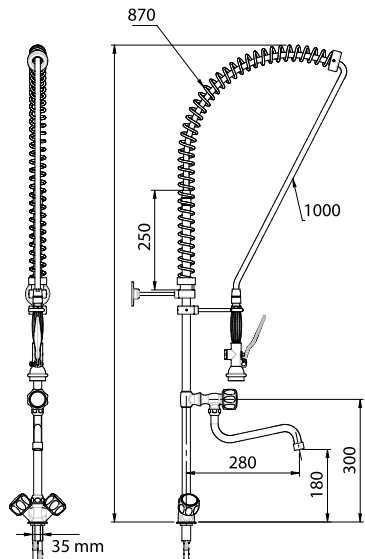

FILLER

- standing faucet, 1-hole with spray washer and elbow spout
- required hole in the sink Ø33-35mm



Code	Price net (€)
651525	506,00

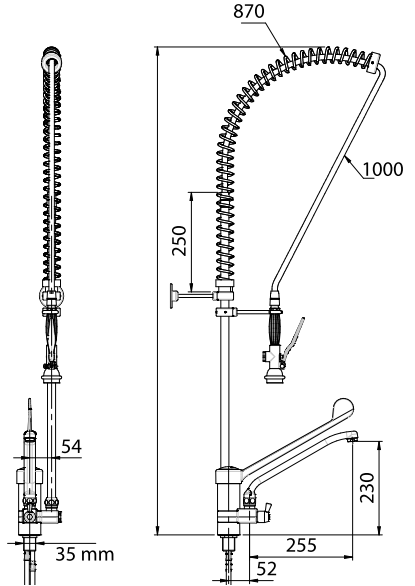

FILLER

- standing faucet, 2-hole with spray washer and spout (wall-mounted)



Code	Price net (€)
651543	372,00

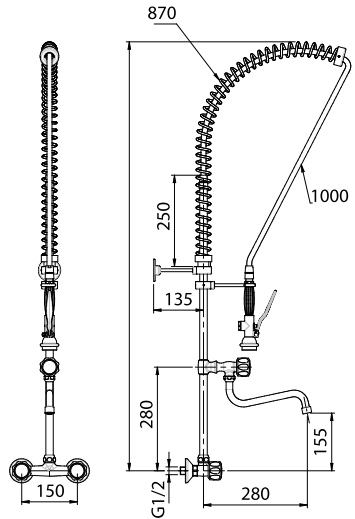

## 0..9

2-Element spice set . . . . .	127
2-Element spice set with napkin holder . . . . .	127
2-Shelf cart . . . . .	155
3-Shelf cart . . . . .	155
4 - Sided grater . . . . .	69
4 Sieving mesh kit . . . . .	60
4-Burner freestanding gas top, self assembly . . . . .	37
4-Burner range with oven . . . . .	5
4-Burner range with oven, eco . . . . .	7
4-Element spice set . . . . .	127
4-Hob electric range with oven . . . . .	12
5-Element spice set . . . . .	127
6-Burner freestanding gas top, self assembly . . . . .	38
6-Burner range with oven . . . . .	6
6-Burner range with oven, eco . . . . .	8
6-Hob electric range with oven . . . . .	13

## A

Accessories for meat grinders . . . . .	247
Accessories for refrigerated / freezing counters and cabinets . . . . .	299
Additional spice containers . . . . .	127
Adjustable confectionery ring . . . . .	217
Airtight lid . . . . .	135
Akendiz cutlery . . . . .	116
Aluminum pans with non-stick coating . . . . .	54
Aluminum pans with non-stick coating, comfort . . . . .	52
Aluminum pans with non-stick coating, comfort graphite . . . . .	52
Aluminum pans with non-stick coating, comfort plus . . . . .	51
Aluminum pans with non-stick coating, platinum . . . . .	53
Angle turner . . . . .	66
Apple peeling and cutting appliance . . . . .	76
Apron . . . . .	315-316
Ardila cutlery . . . . .	110
Ashtray with bin for rubbish . . . . .	319
Automatic coffee grinder with display . . . . .	209
Automatic disinfecting liquid dispenser . . . . .	317
Automatic soap dispenser . . . . .	317
Auxiliary scale . . . . .	77-78, 213

## B

Baguette cutlery . . . . .	117
Bain-marie . . . . .	25
Bain-maries . . . . .	25
Baking gloves . . . . .	241
Baking mat . . . . .	218
Baking paper . . . . .	218
Baking sheet . . . . .	275
Baking tray enameled GN 1/1 . . . . .	274
Bar blender . . . . .	192-193
Bar cabinets, display cabinets . . . . .	298
Bar cutlery . . . . .	105
Bar spoon . . . . .	197
Bar table . . . . .	189
Barrier pole rope . . . . .	190
Bartender container . . . . .	198
Bartender mat . . . . .	198
Bartender strainer . . . . .	195
Bartender's assistant . . . . .	198
Base for oven . . . . .	235

Base for pots . . . . .	48
Base for universal dishwasher . . . . .	328-329
Base with doors . . . . .	29
Bases . . . . .	272
Bases and accessories . . . . .	29
Bases for devices . . . . .	29
Basic line steel vacuum flasks . . . . .	147
Basket adapter . . . . .	334
Baskets . . . . .	130
Bcn colour cutlery . . . . .	118-119
Beverage cooling unit . . . . .	174
Beverage dispenser . . . . .	173
Bistro cutlery . . . . .	106
Black and colored porcelain . . . . .	121
Blade . . . . .	76
Blast chiller . . . . .	300
Blast chillers and freezers . . . . .	300
Blender . . . . .	192-193
Board stand . . . . .	98
Board with a cut-out . . . . .	100
Board with a cut-out GN 1/1 . . . . .	100
Board with a cut-out GN 1/2 . . . . .	100
Boards with cut-out . . . . .	99
Boning knife . . . . .	91, 94
Boning skewer . . . . .	70
Boning strip . . . . .	70
Boston shaker . . . . .	196
Bottle container . . . . .	198
Bowl . . . . .	59, 126
Bread basket . . . . .	130-131
Bread basket with roll-top cover . . . . .	131
Bread knife . . . . .	84, 86, 88-89, 91, 95
Bread roll knife . . . . .	92
Bread tongs . . . . .	73
Breakfast cereals dispenser . . . . .	173
Brewer . . . . .	170
Broth bowl . . . . .	124
Brush . . . . .	217
Brush for cleaning ovens . . . . .	240
Bucket . . . . .	57-58
Bucket base . . . . .	199
Buffet base . . . . .	181
Buffet column . . . . .	180
Buffet columns . . . . .	180
Bulb for heating lamps . . . . .	159
Butcher's block . . . . .	101
Butcher's knife . . . . .	84, 91, 94

## C

Cake fork . . . . .	109, 112, 114, 116-119
Cake platter . . . . .	221
Cake platters . . . . .	221
Cake spatula . . . . .	113, 221
Cake tongs . . . . .	73
Calculator scale . . . . .	78
Calculator scales . . . . .	78
Can opener . . . . .	64, 76
Canteen cutlery . . . . .	107
Cap . . . . .	315
Carbon steel pan . . . . .	50
Cart for pizza dough container . . . . .	240
Cartridge . . . . .	336
Cartridge - one mg+ . . . . .	336
Cartridge - one uf . . . . .	336
Case . . . . .	94-95

Cast iron cookware . . . . .	.55	Countertop connection strip . . . . .	.29
Catering bench . . . . .	189	Cover . . . . .	129, 320
Catering chair . . . . .	189	Cover for 563407 and 563410 . . . . .	240
Catering cutlery . . . . .	104	Cover for 563411 . . . . .	240
Catering furniture . . . . .	189	Covers for catering furniture . . . . .	190
Catering heaters . . . . .	160	Crème brûlée burner . . . . .	222
Catering table . . . . .	189	Crème brûlée dish . . . . .	126
Catering thermal insulation container . . . . .	171	Crepe maker . . . . .	256
Cauldron batch - additional . . . . .	166	Crushed ice machine . . . . .	203
Ceramic cooking top . . . . .	.11	Crushing shafts . . . . .	246
Ceramic tops . . . . .	.11	Cup . . . . .	124-125, 212
Chair cover . . . . .	190	Cup for fries . . . . .	182
Champagne bucket . . . . .	199	Curved boning knife . . . . .	.84
Champagne cork . . . . .	194	Curved decorative knife . . . . .	.75
Cheese knife with two handles . . . . .	.85	Cutlery basket . . . . .	131
Chef's blouse . . . . .	314	Cutlery container . . . . .	332
Chef's case for knives . . . . .	.93	Cutlery cup . . . . .	332
Chef's hat . . . . .	315	Cutlery cup container . . . . .	332
Chef's mallet . . . . .	102	Cutlery for children . . . . .	120
Chef's sweatshirt . . . . .	314	Cutlery rack . . . . .	333
Chest freezer . . . . .	301-302	Cutters . . . . .	217
Chest freezer with stainless steel lid . . . . .	302	Cutting board . . . . .	100-101, 197
Chest freezers . . . . .	301-302	Cutting knife . . . . .	90, 92
Chicken grill . . . . .	258		
Chimney grid net . . . . .	.29	<b>D</b>	
Chimney grid net for modules 1200 mm . . . . .	9, 14, 28	Decorative knives . . . . .	.75
Chimney grid net for modules 400 mm . . . . .	9-11, 14-16, 23-25, 27-28	Decorative butter knife . . . . .	.75
Chimney grid net for modules 800 mm . . . . .	9-11, 14-16, 25, 28	Decorative tips . . . . .	216
Chrome fry tops and grills . . . . .	.17	Deep pan . . . . .	.54
Chrome steel rack . . . . .	156	Deep plate . . . . .	122, 124
Citrus decoration knife . . . . .	.75	Dense-mesh cone sieve . . . . .	.60
Citrus peeling knife . . . . .	.75	Dessert spoon . . . . .	116, 120
Citrus plaster squeezer . . . . .	194	Detergent dispenser . . . . .	329
Citrus squeezer . . . . .	194, 200-201	Diamond steel . . . . .	.87, 94, 96
Classic cutlery . . . . .	109	Dip . . . . .	124
Cleaning liquid for milk frothing systems . . . . .	210	Dishwasher base 400x400 . . . . .	330
Cleaver . . . . .	.85	Dishwasher set with base . . . . .	331
Coarse water filter . . . . .	337	Disinfection unit - fogger . . . . .	323
Cocktail shaker . . . . .	196	Display for GN containers . . . . .	.71
Coffee grinder . . . . .	209	Display for sauce dispensers 5 bottles . . . . .	.72
Coffee grinder or coffee maker knock out drawer . . . . .	213	Display tray . . . . .	175
Coffee grinder with hopper, iconic . . . . .	209	Displays . . . . .	.72
Coffee grinders . . . . .	209	Disposable extrusion bag . . . . .	216
Coffee grounds striker . . . . .	213	Door 400 - left . . . . .	.29
Coffee maker table . . . . .	211	Door 400 - right . . . . .	.29
Coffee spoon . . . . .	109, 112, 114, 117	Door 600 - left . . . . .	.29
Colander . . . . .	.61	Door 600 - right . . . . .	.29
Compact pizza oven . . . . .	226	Doors for bases . . . . .	.29
Compartment vacuum packing unit for packing liquids . . . . .	149	Double adjustable hanging shelf . . . . .	308
Compartment vacuum packing units . . . . .	149	Double contact grill . . . . .	254
Cone sieve . . . . .	.60	Double fryer . . . . .	19-20, 251, 255
Confectionery and cooking ring . . . . .	217	Double fryer with tap . . . . .	255
Connection set . . . . .	.44	Double stove . . . . .	.31
Contact grill . . . . .	253	Double-sided scale . . . . .	196
Contact grills . . . . .	254	Double-walled boiler . . . . .	169
Contactless washbasin with a knee switch and a tap . . . . .	339	Dough container . . . . .	240
Contactless washbasin with knee switch, tap and a soap dispenser . . . . .	339	Dough roller . . . . .	236
Container . . . . .	143, 240, 320	Drip coffee maker . . . . .	210
Cooker . . . . .	168-169	Drip tray . . . . .	168-171
Cookies and fruit platter . . . . .	222	Drop-in bain-marie . . . . .	256
Cooking inserts . . . . .	.48	Drop-in bain-marie with a tap . . . . .	256
Cooking paddle . . . . .	.67		
Cooking technology comparison . . . . .	2		
Cooking top . . . . .	9		
Cooling insert . . . . .	180		
Cork with tube . . . . .	194		

## E

Eco gas ranges	7
Eco restaurant cutlery	108
Egg & cake tray GN 1/1	274
Egg container	144
Egg cutter	74
Egg holder	129
Electric boilers for soups	166
Electric bratt pan	23, 43
Electric citrus squeezer	201
Electric countertop griddle	255
Electric fry top	15
Electric fry top with lid	16
Electric fry top, chrome griddle	17
Electric fry tops	41
Electric fryer	20, 42
Electric gyros knife	257
Electric heater with soup kettles	164
Electric hob top	14
Electric ice crusher	202
Electric kettle	170
Electric pasta cooker	27
Electric ranges	12
Electric soup boiler	166-167
Electric stockpot stove	34
Electric stockpot stoves	34
Electric tilting bratt pan	43
Electronic thermometer	80
Electronic thermometer with movable head	80
E-line pizza oven	229, 231
Enameled frying tray	274
External core probe	273
External multi-point probe	273
External sous-vide probe	273
Extrusion bag standard	216

## F

Fast food trays	179
Faucet with extendable shower	342
Fifo container	144
Fifo sauce dispenser	72
Filler	344-346
Fillers	344
Filleting knife	88, 95
Finger food basket	183
Finger food slate plate	181
Finger food spoon	184
Finger food utensils	182
Fish knife	84
Fish pan	54
Fish scraper	74
Fish spatula	63
Flat plate	122, 124-125
Flexible filleting knife	84, 94
F-line pizza oven	230
Foam whipping head	224
Food dryer, 10 trays dehydrator	258
Food heating lamp	159
Fork	89, 95
Freestanding devices	30
Freestanding electric fry top	41
Freestanding electric fryer	42

Freestanding electric hob top	40
Freestanding electric hob tops	40
Freestanding gas top	35-36
Freestanding gas tops	35
Free-standing ice cube machines	204
Freestanding induction cooker	39
Freezer, two doors	279
Freezing counter	283
French fries stand	182
Fries scoop	67
Fries warmer	21
Fr-line pizza oven	234
Frother	217
Frozen beverage dispenser	174
Fruit basket	222
Fruit platter	222
Fry tops and grills	15
Fryer	255
Fryers	19-20, 251
Fuel and gel container	165
Full enameled baking tray	274
Funnel	68

## G

Garlic squeezer	74
Gas bratt pan	22
Gas fry top	15
Gas fry top, chrome griddle	17
Gas fryer	19
Gas pasta cooker	26
Gas range	5
Gas stockpot stove	31
Gas-line pizza oven	233
Glassware dishwasher with detergent dispenser	330
Glassware dishwasher with detergent dispenser and a drain pump	330
Glassware rack	333-334
Glassware washer	330
Glue for insecticide lamp 692315	321
GN 1/1	133, 274
GN 1/1 electric heater	162, 164
GN 1/1 heater	160-161, 163
GN container 1/1	133-134, 136-141
GN container 1/1 non-stick	133
GN container 1/12	135
GN container 1/2	134, 136-141
GN container 1/3	134, 136, 138-141
GN container 1/4	135, 138-141
GN container 1/6	135-136, 138-141
GN container 1/9	135, 138, 140, 142
GN container 2/1	134, 137
GN container 2/3	134, 137, 141
GN container 2/4	134
GN cover with holes for the handle	136
GN lid	133, 135, 138-139
Gredil cooker	168
Gredil pizza oven	227
Gredil pots	46
Grid for chicken	275
Grid for frying fries, vegetables and fish GN 1/1	274
Grill grid 1/1 gn	274
Grill hob	55
Grill non-stick tray GN 1/1	274
Grill pan	55

- Grill tongs . . . . . 73  
 Guide rails for cabinets and counters . . . . . 299  
 Guide rails for hanging glasses . . . . . 200  
 Gun . . . . . 219  
 Gun for sauces and creams . . . . . 219
- ## H
- Haccp 450x300 cutting board . . . . . 98  
 Haccp 600x400 cutting board . . . . . 99  
 Haccp board set . . . . . 98  
 Haccp cutting board GN 1/1 . . . . . 99  
 Haccp cutting board GN 1/2 . . . . . 99  
 Haccp cutting boards . . . . . 98  
 Hand towel dispenser . . . . . 317  
 Hanger with hooks . . . . . 64  
 Hanging cabinet (sliding door) . . . . . 307  
 Hanging cabinet (swinging door) . . . . . 307  
 Hanging heating lamp . . . . . 186  
 Hanging heating lamps . . . . . 186  
 Head . . . . . 336  
 Head cartridge . . . . . 336  
 Heating component for heaters . . . . . 165  
 Heating display . . . . . 258  
 Heating lamp . . . . . 187-188  
 Heating lamps . . . . . 187  
 Heating lamps for dishes . . . . . 159  
 Heating table . . . . . 187  
 Hexagonal grate . . . . . 69  
 Hidraulic cutlery . . . . . 117  
 High pot . . . . . 46-47  
 High pot with tap . . . . . 48  
 Hood . . . . . 273  
 Hood-type dishwasher . . . . . 326-327  
 Hood-type dishwasher with built-in detergent dispenser . . . . . 326-327  
 Hood-type dishwasher with built-in detergent dispenser and a rinse boosting pump . . . . . 327  
 Hood-type dishwasher with built-in detergent dispenser, rinse boosting pump and a drain pump . . . . . 327  
 Horizontal decorative channel knife . . . . . 75  
 Hot chocolate appliance . . . . . 220  
 Hotel pole . . . . . 190
- ## I
- Ice cream cone rack . . . . . 215  
 Ice cream cuvette . . . . . 215  
 Ice cream spatula . . . . . 215  
 Ice crusher . . . . . 202  
 Ice cube machines intended for built-in installation . . . . . 205  
 Ice dispenser . . . . . 202  
 Ice flake maker . . . . . 206  
 Ice machine . . . . . 203, 206  
 Ice tongs . . . . . 73-74  
 Ice transport container . . . . . 144  
 Induction cooker . . . . . 10, 261-262  
 Induction ranges . . . . . 10  
 Induction rangetops . . . . . 39  
 Induction stockpot stove . . . . . 33  
 Induction stockpot stoves . . . . . 33  
 Induction wok . . . . . 24  
 Insecticidal lamp . . . . . 321-322  
 Insecticidal lamp with a fan . . . . . 322  
 Insecticidal lamp, led . . . . . 321  
 Insecticide lamp . . . . . 321
- Installation kit . . . . . 273  
 Installation kit for connection of 1 convection steam oven with a hood or steam condensate . . . . . 273  
 Installation kit for connection of 2 convection steam ovens with a hood or a steam condenser . . . . . 273  
 Installation kit for hydraulic connection of 1 convection steam oven . . . . . 273  
 Installation kit for hydraulic connection of 2 convection steam ovens without a hood . . . . . 273  
 Insulating balls . . . . . 263  
 Isabell porcelain . . . . . 123
- ## J
- Japanese knife . . . . . 85  
 Japanese knife sashimi . . . . . 90  
 Japanese santoku knife . . . . . 85  
 Jar . . . . . 192-193
- ## K
- Kanadi cutlery . . . . . 116  
 Kids cutlery . . . . . 120  
 Kitchen knife . . . . . 84, 86-90, 92, 94-95  
 Kitchen scissors . . . . . 101  
 Kitchen tools . . . . . 64  
 Kitchen tools carving set . . . . . 75  
 Kneading-through . . . . . 224  
 Knife for cutting pastry . . . . . 220  
 Knife sharpener . . . . . 96  
 Knife sharpening device . . . . . 97  
 Knives kits . . . . . 94  
 Knives set . . . . . 96
- ## L
- Ladle . . . . . 62-65, 129  
 Laminated tray . . . . . 176  
 Lamp for 692211 . . . . . 321  
 Lamp for 692216 . . . . . 321  
 Lamp for 692221 . . . . . 321  
 Latch cover gn . . . . . 140  
 Latte spoon . . . . . 118-119  
 Lava grill . . . . . 18  
 Lava grill (grate s) . . . . . 18  
 Lava grill (grate v) . . . . . 18  
 Lava stones . . . . . 18  
 Leaf tip . . . . . 216  
 Led lamp for 692116 . . . . . 321  
 Led lamp for 692213 . . . . . 321  
 Lemon squeezer . . . . . 74, 194  
 Lid . . . . . 57, 143, 175, 320  
 Lid for 068080 . . . . . 320  
 Lid for 068120 . . . . . 320  
 Light dough mixing tip . . . . . 224  
 Liquid dispenser . . . . . 317  
 Low pot . . . . . 47
- ## M
- Magnet strip . . . . . 93-95  
 Magnet strip with jooks . . . . . 93  
 Mandoline slicer . . . . . 76

Matrix	153
Maxi pinafore	316
Measuring cups	69
Measuring jug	69
Measuring spoon	69
Meat grinder	246-247
Meat knife	88, 95
Meat mallet	102
Meat tenderizer	102
Medium pot	46-47
Menu holder	129, 184
Microwave	259-261
Midi pinafore	316
Mini bucket	182
Mini colander	184
Mini dip	182
Mini pinafore	316
Mini saucepan	184
Module of 2 drawers for refrigerated tables GN 1/1	299
Monoblock kitchen tools	62-63
Mortar	195
Mortar with pestle	129
Mug	125-126, 184
Multifunction brush	322
Multifunction pan	23
Multifunctional convection oven	44

## N

Napkin holder	128
Narrow boning knife	84
Navia cutlery	111
Neutral elements	28
Neutral station	28
Neutral station with 2 drawers	28
Neutral station with drawer	28
Non-contact digital thermometer	80
Non-contact faucet with infrared sensor	342
Non-stick frying tray	274
Non-stick pan	50
Notching knife	84

## O

Open base	29
Opener	195
Organic waste shredder	338
Organic waste shredders	338
Oven	44
Oven gloves	241
Oven grate 2/1	6
Oven grate GN 2/1	12-13
Oven grate gn2/1	5
Overflow plug with a screen	339
Overflow plug with strainer	312
Ozone generator	323

## P

Paddle	67
Pan	23, 43, 49, 51-54
Pan with granite coating	52
Pancake maker	256
Pancake pan	51-54

Pancake pan with granite coating	52
Panini contact grill	254
Pans	22, 49
Pass-through cabinet (sliding doors)	311
Pasta basket (standard GN 1/3)	26-27
Pasta basket (standard GN 1/6)	26-27
Pasta cooker	26-27
Pasta plate	126
Pastry picker	217
Pastry tongs	73
Peeler	244
Peeler corrugated blade	101
Peeler smooth blade	101
Peelers	101
Peeling knife	85-86, 89, 92, 94-95, 197
Perforated spatula	85
Perforated spoon	63, 65, 184
Petal tip	216
Pinafores	316
Pitcher	125-126, 172, 212
Pizza bag	146, 241
Pizza cutting wheel	239
Pizza mesh	241
Pizza oven	226
Pizza peel	240
Pizza plate	126
Pizza spade	239-240
Pizza spatula	239
Pizza tray	241
Planetary mixer	223-224
Plastic basket for chest freezers	302
Plastic scraper	217
Plastic thermos	146
Plate drip tray	332
Plate rack	333
Platform cart	154
Platter	55, 175
Platter under the platex	175
Plug	312, 339
Plug socket	312, 339
Pneumatic switch	338
Polycarbonate tongs	73
Polyethylene transport thermal containers	145
Polypropylene GN catering containers with lid	141
Polypropylene GN catering containers, premium	140
Polypropylene GN catering containers, standard	139
Pot with cup and saucer	126
Poultry shears	89, 101
Premium buckets of stainless steel	57
Premium haccp stainless steel knives	90
Premium line pots	47
Pre-school cutlery	120
Probe	273
Professional extra powerpizza ovens	234
Professional gas strongpizza ovens	233
Professional strong pizza oven	229
Professional pizza oven	227
Professional strongpizza oven	231
Protective gloves	317
Punching roller	217
Purity 1200 clean	335
Purity 450	335
Purity 450 steam	335
Purity c head by-pass 0%	336
Purity c head by-pass 30%	336
Pyramid heating lamp	188



## R

Rack for 3 hot dogs . . . . .	72
Rack trolley . . . . .	333
Receipt tray . . . . .	70
Reception bell . . . . .	70
Reducer cap . . . . .	29, 35-38
Reducer cap for grate . . . . .	5-6, 9, 31
Reducer overlay . . . . .	35-38
Refrigerated & freezing counters . . . . .	281
Refrigerated and freezing cabinets and display cabinets . . . . .	292
Refrigerated and freezing pizza counters . . . . .	287
Refrigerated bottle display cabinet . . . . .	207, 298
Refrigerated counter . . . . .	282-283
Refrigerated counter with glass door . . . . .	283
Refrigerated display cabinet . . . . .	180, 292-293, 296-297
Refrigerated display case . . . . .	289-290
Refrigerated or freezing cabinet . . . . .	293-295
Refrigerated or freezing counter . . . . .	281
Refrigerated or freezing display cabinet . . . . .	292
Refrigerated pizza counter . . . . .	242, 288
Refrigerated pizza counter 600x400 . . . . .	291
Refrigerated pizza counter on wheels . . . . .	288
Refrigerated pizza counter with display case . . . . .	242, 287
Refrigerated pizza counter with display case on wheels . . . . .	242
Refrigerated salad counter . . . . .	284-286
Refrigerated salad counters . . . . .	284
Refrigerator / freezer, one door . . . . .	280
Refrigerator / freezer, two doors . . . . .	280
Refrigerator for coffee milk . . . . .	210
Refrigerator-freezer, one door . . . . .	280
Refrigerators & freezers . . . . .	279
Removable cartridge . . . . .	337
Removable cartridge for 823045 . . . . .	335
Removable cartridge for 823402 . . . . .	335
Removable cartridge for 824130 . . . . .	335
Restaurant cutlery . . . . .	114
Ribbon tip . . . . .	216
Rice cooking appliance . . . . .	257
Rice portioner . . . . .	74
Ring bucket . . . . .	57
Roast tongs . . . . .	73
Roasting knife . . . . .	84, 86, 89, 95
Roller knives set with a strip . . . . .	95
Roller . . . . .	218
Roller heater for sausages . . . . .	251
Roll-top heater . . . . .	162
Roll-top heater GN 1/1 . . . . .	161-162
Rose tip . . . . .	216
Round catering table . . . . .	189
Round cuvette . . . . .	215
Round heater . . . . .	160
Round tip . . . . .	216
Rs232 port with cable for connecting cash register / computer / pos . . . . .	77

## S

S.S.T. Containers with thermal insulation . . . . .	148
Safety cabinet . . . . .	318
Salad spinner . . . . .	58
Salad-bowl . . . . .	122, 124, 126
Salmon knife . . . . .	84
Sandwich display with 5 compartments . . . . .	72

Sandwich holder . . . . .	252
Sanelli knives . . . . .	86
Sanelli knives premana professional line . . . . .	82
Sanelli knives set . . . . .	85
Sanelli steel . . . . .	96
Sannelli set with strip . . . . .	94
Santoku knife . . . . .	87, 94
Sauce dispenser . . . . .	72
Sauce dispenser with pump . . . . .	72
Sauceboat . . . . .	129
Saucepan . . . . .	48
Saucer . . . . .	124
Sausage filler . . . . .	248
Sausage fillers . . . . .	248
Sausage slicer . . . . .	248
Scale . . . . .	77-78, 196
Scissors . . . . .	101
Scoop . . . . .	68
Screw-joined furniture for self-assembly . . . . .	306
Segura cutlery . . . . .	112
Serving accessories . . . . .	65, 184
Serving cart . . . . .	155
Serving cart eco . . . . .	155
Serving cart premium . . . . .	155
Serving cart standard . . . . .	155
Serving carts . . . . .	155
Serving case GN 1/1 . . . . .	180
Serving spoon . . . . .	63-65, 184
Set of forged knives with a cover . . . . .	94-95
Set of guide rails for cabinets GN 2/1 . . . . .	299
Set of guide rails for counters GN 1/1 . . . . .	299
Set of knives . . . . .	85
Set of two baskets . . . . .	42
Set of two baskets for 9725000, 9726000 . . . . .	20
Set of wheels for chest freezers . . . . .	302
Sharpening device . . . . .	97
Shelf for cabinets 880173, 880175, 880400, 880402, 880405 . . . . .	299
Shelf for cabinets 880600, 880602, 880604 . . . . .	299
Shelf for cabinets GN 2/1 . . . . .	299
Shelf for counters GN 1/1 . . . . .	299
Shelf for devices with a compartment of 600x400 mm . . . . .	299
Shelf for display cabinet 882151 . . . . .	299
Shelf with spice containers . . . . .	71
Shelves for cabinets and counters . . . . .	299
Shower faucet . . . . .	340-342
Shower kit . . . . .	275
Shower set . . . . .	43
Shredding knife . . . . .	84
Steve . . . . .	60-61
Sifting mesh . . . . .	60
Single adjustable hanging shelf . . . . .	308
Single contact grill . . . . .	254
Single fryer . . . . .	19-20, 42, 251, 255
Single fryer with tap . . . . .	255
Single stove . . . . .	31
Single-compartment furnace . . . . .	226-228
Siphon cartridges . . . . .	215
Size tables . . . . .	314-315
Skeletal base . . . . .	29
Slate plate . . . . .	180-181
Slicer for cured meat . . . . .	245
Slicer for cured meat and cheese . . . . .	245
S-line pizza oven . . . . .	232
Slotted spoon . . . . .	62-65, 67
Slotted tub . . . . .	61
Smoked meat knife . . . . .	84
Smooth board . . . . .	100

Snail accessories	128
Snail fork	128
Snail plate	128
Snail tongs	128
Soap dispenser	317
Soda siphon	200
Soda siphon cartridges	200
Soft cheese knife	91
Soup boiler	166
Soup ladle	111, 113
Soup vase	129
Sous-vide cooking circulator	263
Sous-vide GN 1/1 cooking circulator	263
Sous-vide insulating balls	152
Spacing marker	219
Spaghetti spoon	63-64
Spaghetti tongs	73
Spatula	63-65, 85, 220
Spatula for confectionery	66, 220
Spatulas	66
Spice dispenser	212
Spice grinder	129
Spiral mixer	236-238
Stacking kit	273
Stainless steel buckets	57
Stainless steel GN catering containers, basic	138
Stainless steel GN catering containers, comfort	133
Stainless steel GN catering containers, premium	133
Stainless steel GN catering containers, standard	134
Stainless steel GN catering containers, with mobile handgrips, standard	136
Stainless steel grill	275
Stainless steel gn catering containers, perforated, standard	137
Stalgast dishwashers	325
Stalgast dishwashers aqua series	328
Stalgast elite forged knives	87
Stalgast haccp knives of rolled steel	92
Stalgast knife case	95
Stalgast knife made of forged steel	88
Stalgast knives of rolled steel	89
Stand	219
Stand for automatic dispensers	317
Stand for dispensers	317
Standard line auxiliary stockpot stove	32
Standard line power stockpot stove	32
Star tip	216
Steak and pizza cutlery	119
Steak and pizza knife	119
Steak maker	246
Steel	85, 89, 95-96
Steel cup for sifting	218
Steel GN catering containers, standard	137
Steel mug for shaker	196
Steels	96
Stewing pot	48
Storage cabinet (swinging door)	311
Storage rack GN 1/1	157
Storage rack solid shelves	308
Store scale	79
Store scales	79
Straight boning knife	84
Straight roller blade	64
Strip packer	151
Strip vacuum packing machines	151
Sugar bowl	125
Sugar/ice tongs	74
Suspended heating lamp for the umbrella	186

## T

Table bin	129, 319
Table cover	190
Table fork	104-119
Table knife	104-120
Table pastry fork	120
Table spoon	104-120
Table vacuum flask	171-172
Table with a double chamber sink with a shelf	309
Table with a double chamber sink without a shelf	309
Table with a single-chamber basin	307
Table with a single-chamber sink with a shelf	308-309
Tabletop brush	322
Tabletop scales	77
Tambre cutlery	113
Tamper	213
Tea spoon	104-119
Temperature indicator	80
Terrine mold	60
Thermal insulation container for ice	199
Thermal insulation container for wine	199
Thermo-hygrometer	80
Thermometer	80
Thermometer probe	80
Three-chamber matrix	153
Titanium-coated pan	50
Titanium-coated pans	50
Toaster	252
Tomato hollower	75
Tomato knife	85-86
Tongs	65
Top line stockpot stoves	31
Transport cart for GN containers and baking trays	154
Transport container	143
Trash can	319
Trash cover 067060	319
Tray	177-178
Tray basket GN 1/1	333
Tray sealing machine	153
Tray stand	179
Trays	177
Tub	59
Turia cutlery	115
Turner	66, 94
Turning fork	63-64
Tweezers for fish-bone removal	74
Two-chamber matrix	153
Two-compartment furnace	226-228
Type s fish grate for 400 units	18

## U

Universal basket	130, 333
Universal dishwasher	329
Universal dishwasher 500x500 with detergent dispenser	328
Universal dishwasher 500x500 with detergent dispenser and a drain pump	328
Universal dishwasher 500x500 with detergent dispenser and a rinse boosting pump	328
Universal dishwasher 500x500 with detergent dispenser, a drain pump and a rinse boosting pump	328
Universal dishwasher power digital	328
Universal dishwasher with base	331





## Contact us



**Stalgast sp. z o. o.**  
03-736, Plac Konesera 9  
Warsaw, Poland



[www.stalgast.eu](http://www.stalgast.eu)  
**E-mail:**  
[export@stalgest.com](mailto:export@stalgest.com)

KSENSD\_2023\_07\_31

